

Tutorials for MASTAN2 and Related Validation

RESEARCH REPORT RP21-03

MARCH 2021

Committee on Specifications
for the Design of Cold-Formed
Steel Structural Members



American Iron and Steel Institute

DISCLAIMER

The material contained herein has been developed by researchers based on their research findings. The material has also been reviewed by the American Iron and Steel Institute Committee on Specifications for the Design of Cold-Formed Steel Structural Members. The Committee acknowledges and is grateful for the contributions of such researchers.

The material herein is for general information only. The information in it should not be used without first securing competent advice with respect to its suitability for any given application. The publication of the information is not intended as a representation or warranty on the part of the American Iron and Steel Institute, or of any other person named herein, that the information is suitable for any general or particular use or of freedom from infringement of any patent or patents. Anyone making use of the information assumes all liability arising from such use.

PREFACE

This report creates the tutorials helping engineers to correctly model and analyze structural systems comprised of non-doubly symmetric sections using the latest version of MASTAN2. The report also validated a MASTAN2 model using non-doubly symmetric sections against results from a small test program. The following report and tutorials are provided:

AISI Small Project Summary - Tutorials for MASTAN2 and Related Validation

- Tutorial for MASTAN2 v5.1 - Introductory Frame
- Tutorial for MASTAN2 v5.1 - Pour Stop Beam
- Tutorial for MASTAN2 v5.1 - Steel Joist

The input files for tutorial examples can be downloaded from the link below:

1. Frame tutorial example:
https://www.dropbox.com/s/u3gik4k8ww9bppi/Frame_End.mat?dl=0
2. Pour-stop example:
https://www.dropbox.com/s/27qfsqsvqo3iliq/Pour_Stop.mat?dl=0
3. Joist tutorial example:
<https://www.dropbox.com/s/mzizxw5ki9byyff/Joist.mat?dl=0>



Department of Civil and
Environmental Engineering
UNIVERSITY OF WISCONSIN-MADISON

AISI Small Project Summary – Tutorials for MASTAN2 and Related Validation

Edward J. Sippel, Hannah B. Blum, Ronald D. Ziemian, Joe Pote, & Scott Morton

Sections

- Project Overview
- Tutorial Description
- Experimental Configuration
- Modeling with MASTAN2
- Results
- Summary



Project Overview

1/26/2021



Department of Civil and
Environmental Engineering
UNIVERSITY OF WISCONSIN-MADISON

Project Objectives

- To create tutorials for engineers on how to correctly model and analyze structural systems comprised of non-doubly symmetric sections using the latest version of MASTAN2.

Result: Created 3 step-by-step tutorials with multiple screenshots.

- To validate a MASTAN2 model using non-doubly symmetric sections against results from a small test program.

Result: Assembled a small system with 2 open web steel joists. Subjected system to two loading sequences resulting in two sets of data to compare against MASTAN2 against. Results show good agreement.

Tutorial Description



General Tutorial Structure

- Each tutorial starts with an introduction of MASTAN2 and the problem to be solved.
- The initial model is constructed, and an initial evaluation is completed.
- The base model is altered for a second scenario and analyzed again.
- Lastly, some additional piece of information related to the structural analysis is provided.
- No one tutorial covers all features in MASTAN2. As a group, these tutorials cover most of the new features offered.

Tutorial 1 – Introductory Frame

- A single bay, single story portal frame was analyzed in 2-D and then 3-D to show the impact of warping in the modeling process.
- An interior column was added, and non-doubly symmetric abilities were introduced.
- The impact of accounting for the non-doubly symmetric section properties in the overall stability of the frame was highlighted.

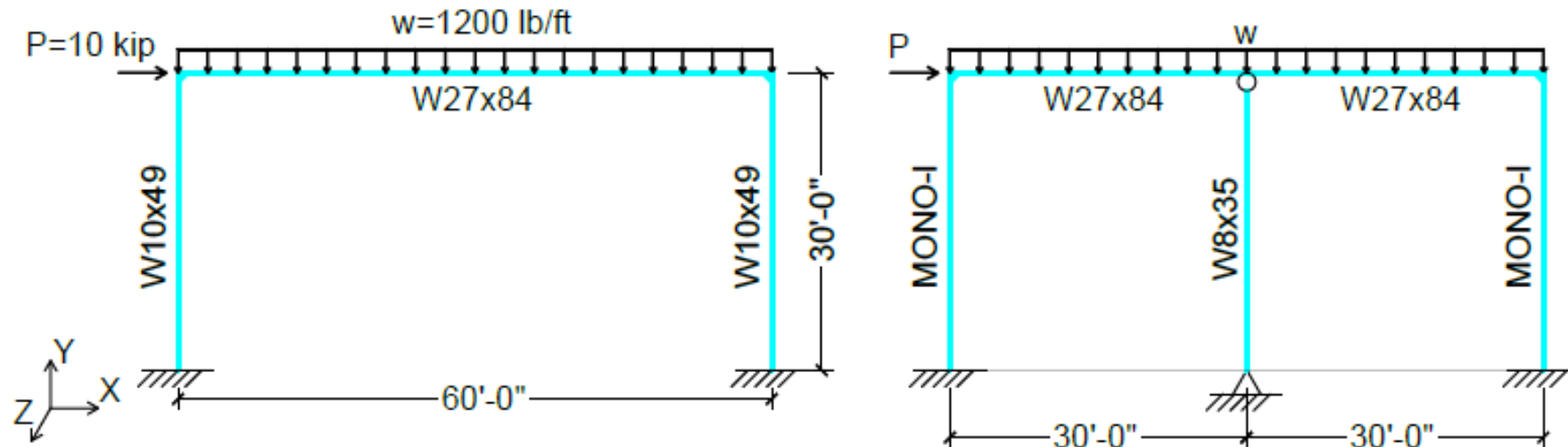

Tutorial 2 – Pour Stop Beam

- A non-doubly symmetric beam was subjected to uniform distributed loading including both transverse shear and torsional moment.
- Details on calculating stresses from MASTAN2 results are provided.
- The abilities of multiple new features of MASTAN2 are presented

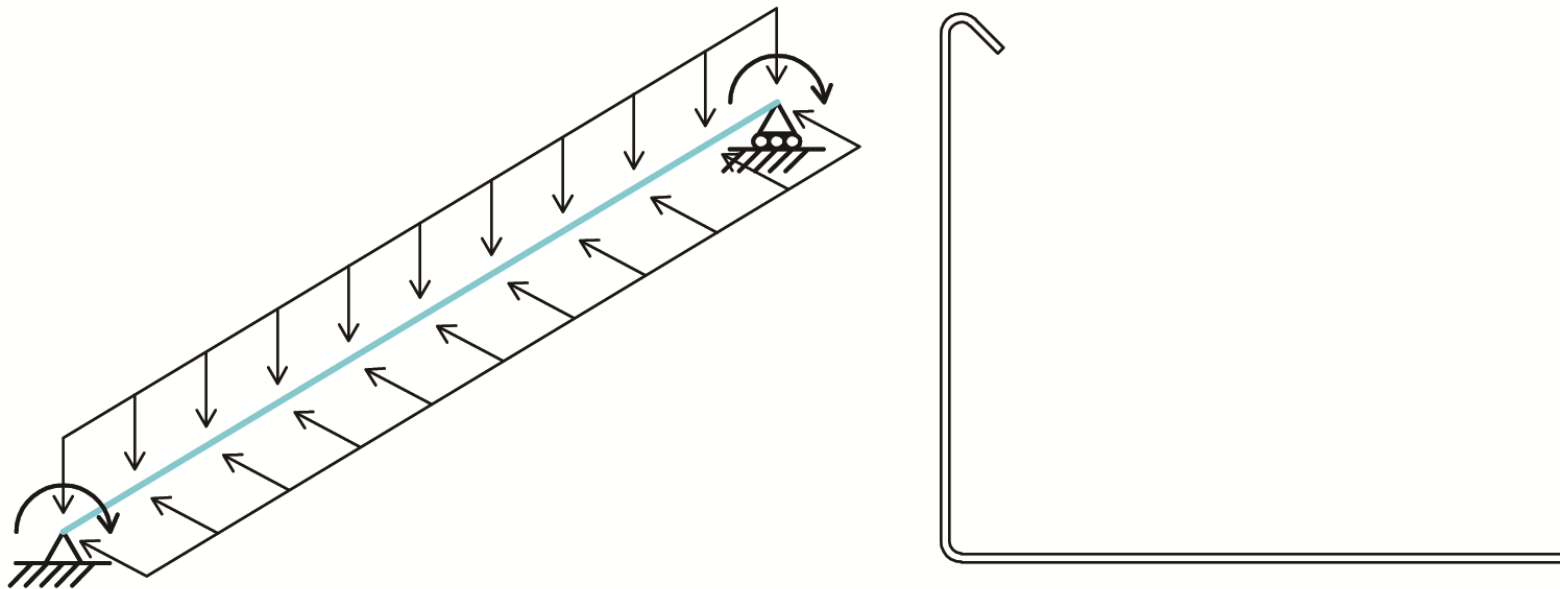

Tutorial 3 - Joist

- A joist model was subjected to uniform loading and then a hanging load.
- The model is built using the new import function to create the base geometry and then refined within MASTAN2.

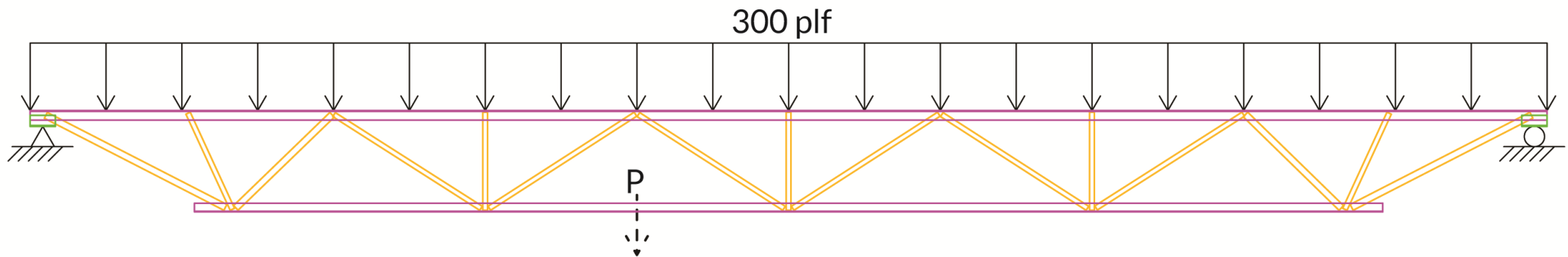

- Note: It is similar to the experimental set-up.

Experimental Configuration



Experimental Set-up

- (2) 20' – 16K2A Joists with rolled angle top and bottom chords with rolled channel webs
- Joists braced with cross bracing at end of bottom chords and decking



Test Program

- Scenario 1:
 - Joist was subjected to a uniform distributed loaded applied via barrels with aggregate.
 - At ~0.5 design live load (152 plf) and ~1.0 design live load (304 plf), the bottom chord was subjected to 100 lbs of a hanging load, P
- Scenario 2:
 - No uniform load was applied to joist.
 - The bottom chord was subjected to 280 lbs of a hanging load, P
- In both cases the hanging load was applied near midspan away from the web intersections

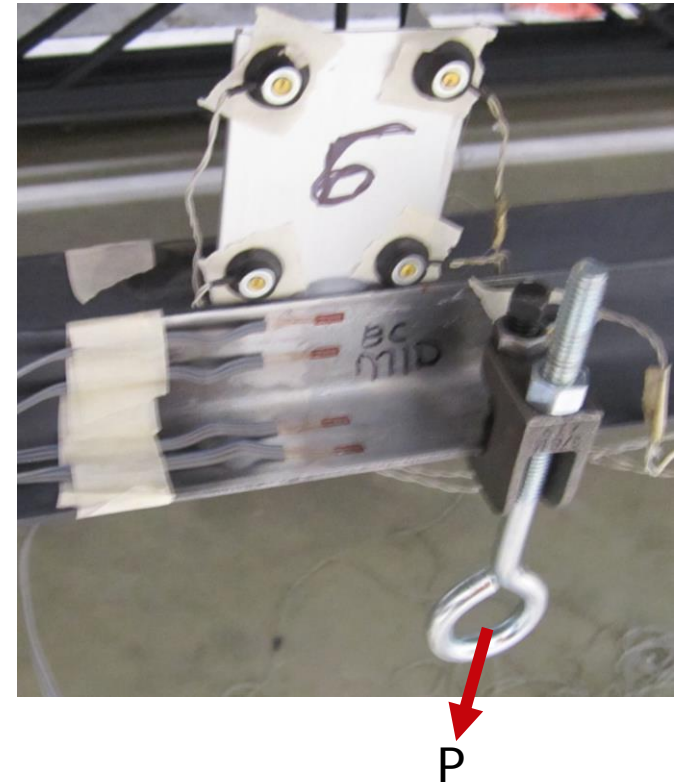

Testing Images – Scenario 1: Half Live Load



Testing Images – Scenario 1: Full Live Load



Testing Images – Scenario 2

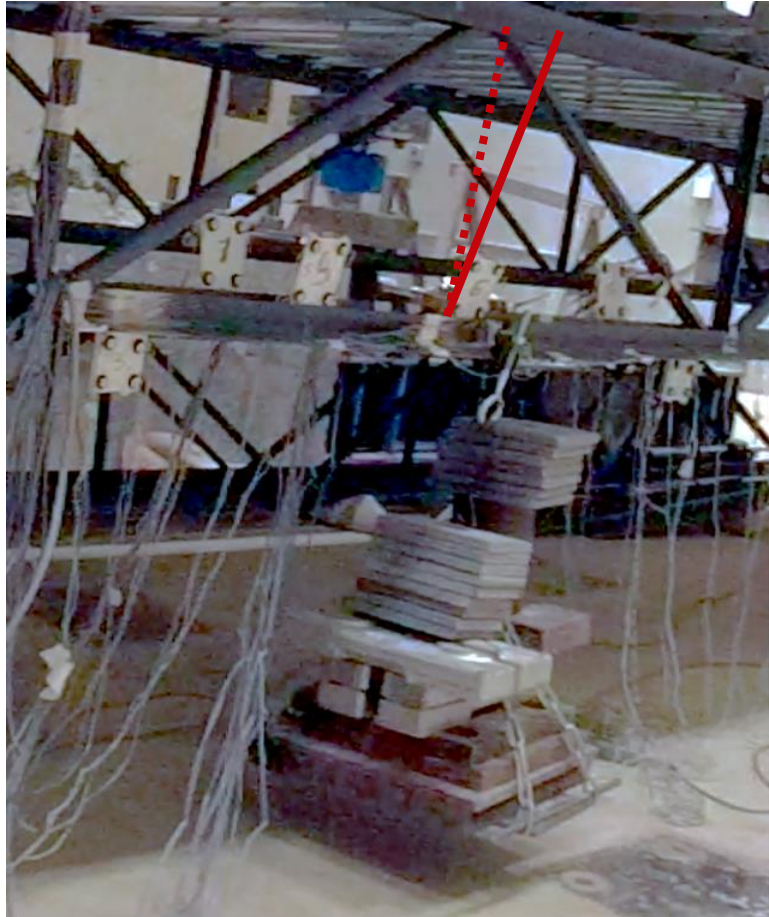

Recorded Information

- Recorded displacements using Optotrak system for key translations and rotations.
- Recorded strain data at 5 locations. Each cross section included 4 linear strain gages and 1 shear strain gage to be able to approximate internal forces.

Strain Measurement Locations

- 1 – Top of Vertical Web
- 2 – Bottom of Middle Web
- 3 – End of Loaded Chord
- 4 – Midspan of Loaded Chord
- 5 – Midspan on Other Chord

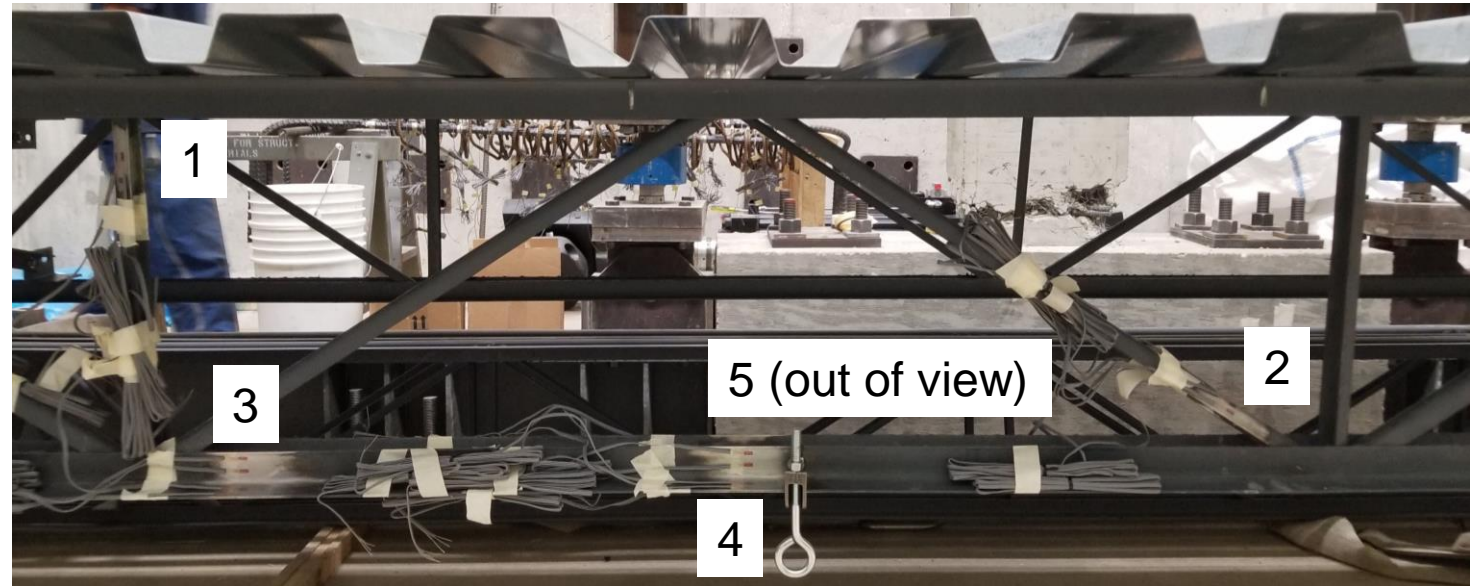

Modeling with MASTAN2



MASTAN2 Model

- Joist members were modeled in an ideal location with a single node connection for the intersection of the webs. The ends of the webs were defined to be fixed for out-of-plane bending, released for in-plane bending (typical joist web pinned design condition), and fixed for warping at the end.
- All members were modeled with the nominal cross section properties in a principal orientation.
- Top chord was laterally supported at web intersections, ~24" o.c.
- Bottom chord was laterally supported 8" from end web intersection. Connection was inserted above the bottom chord to allow additional twist.

Cross Section Information

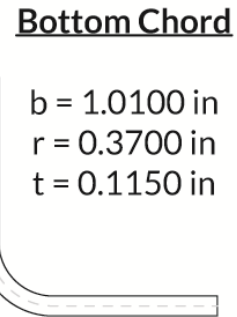
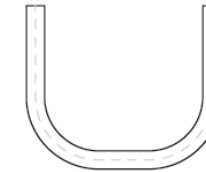
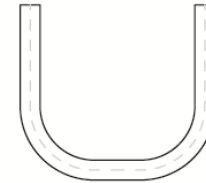
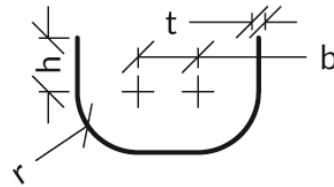
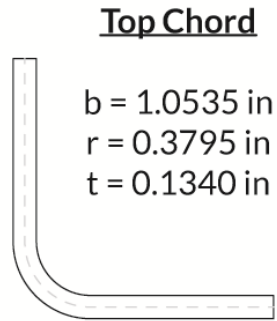
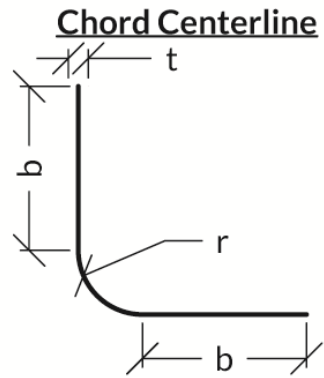

$h = 0.5844$ in
 $b = 0.2700$ in
 $r = 0.3700$ in
 $t = 0.1150$ in

$h = 0.5258$ in
 $b = 0.2900$ in
 $r = 0.3650$ in
 $t = 0.1050$ in

$h = 0.3102$ in
 $b = 0.3466$ in
 $r = 0.3509$ in
 $t = 0.0767$ in

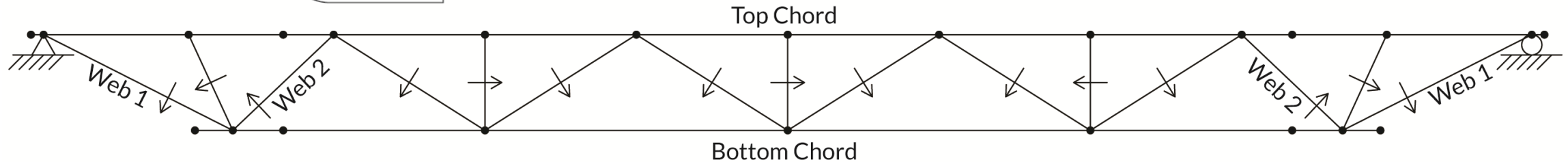

Arrows indicate the open side of the web channels. Web members not otherwise labeled are Web 3

MASTAN2 Loading

- The model includes uniform load applied to each top chord. The loaded load is applied in the global Y direction which causes it to be split into the member's principal orientation.
- The hanging load is applied via a vertical 2.5 inch 3/8" round steel rod modeled at the end of a horizontal 1.5 inch rigid link extending from the centroid of the bottom chord. The hanging load is applied at the end of the vertical rod to account for movement of the eye bolt.
- The results shown account for the uniform load being applied and then the hanging load being added to the model in a 2nd order elastic analysis.



Results

Example Recorded Information

- Strain gage information during Scenario 1

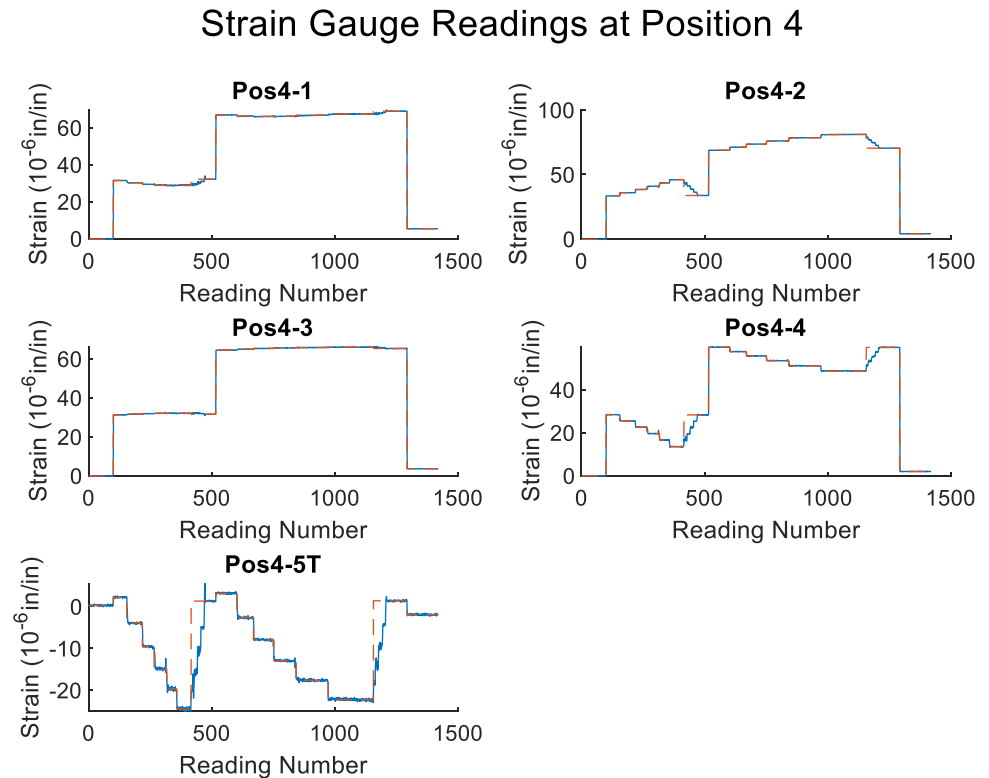
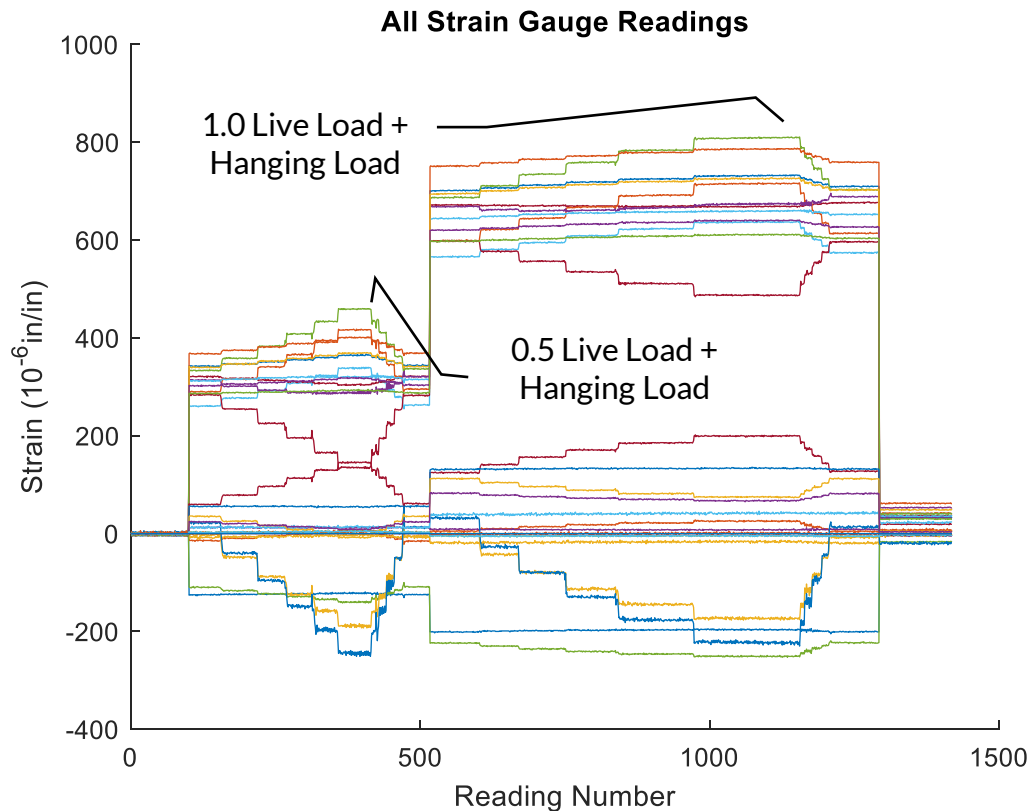

Calculations with Joist Experiment Results

- The displacement information was measured at a few critical locations for comparing translations.
- Most of the displacement information was used to calculate the twist of the bottom chord at the 10 sensor group locations.
- At each sensor group, the Euler angle and axis was calculated using 3 of the 4 displacement measurements and the component of that angle about the original x-axis was determined. The final rotation presented was based on the average of the 4 combinations.

Calculations with Joist Experiment Results

- Using the strain gauge measurements, internal forces were calculated.
- Two scenarios were considered:
 - 1) Bimoment and warping were significant meaning all 4 linear strain measurements were needed to define the resulting internal forces.
 - 2) Warping was negligible and only 3 strain measurements were need to define the internal forces. The resulting forces were calculated excluding one gage and the 4 solutions were averaged.
- The internal forces considered are
 - Axial Force, P
 - Bending Moment about the y -axis, M_y
 - Bending Moment about the z -axis, M_z
 - Bimoment from warping, B

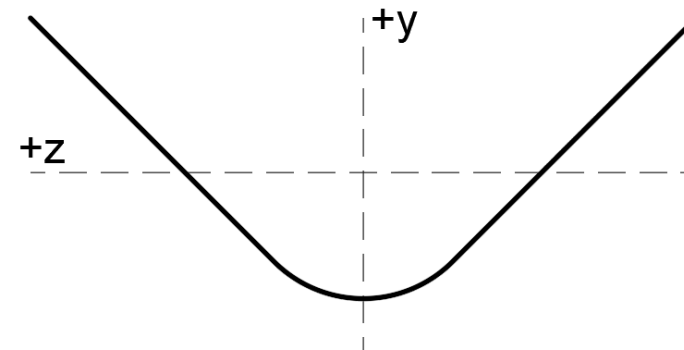

Stress Distributions

- Using the internal forces calculated from the experiment and pulled from MASTAN2, the centerline normal stress diagrams were calculated.
- Relationship between normal stress and the internal forces:
 - The same relationship was used for calculation on the previous page.

$$\sigma_x = \frac{P}{A} - \frac{M_z y}{I_{zz}} - \frac{M_y z}{I_{yy}} + \frac{B \omega_n}{C_\omega}$$

- A closely spaced path of nodes along the element centerline was defined. The above relationship was evaluated at each position.

General Comment

- Results related to Position 1 and 2 are not shown. The measurements were taken 3 inches vertically from the extremes of the joist in an attempt to verify the end conditions of the web . This placed the measurements a little farther than the maximum dimension of the web channel away from the welded connection.
- While the individual strain gauge measurements displayed the anticipated stepwise changes in strain corresponding to the applied hanging load, the results indicated that there were likely stress concentration effects being captured from being too close to the welded connection. This effect cannot be captured in MASTAN2 and as such was not shown here.

Reference for Rotation Plots

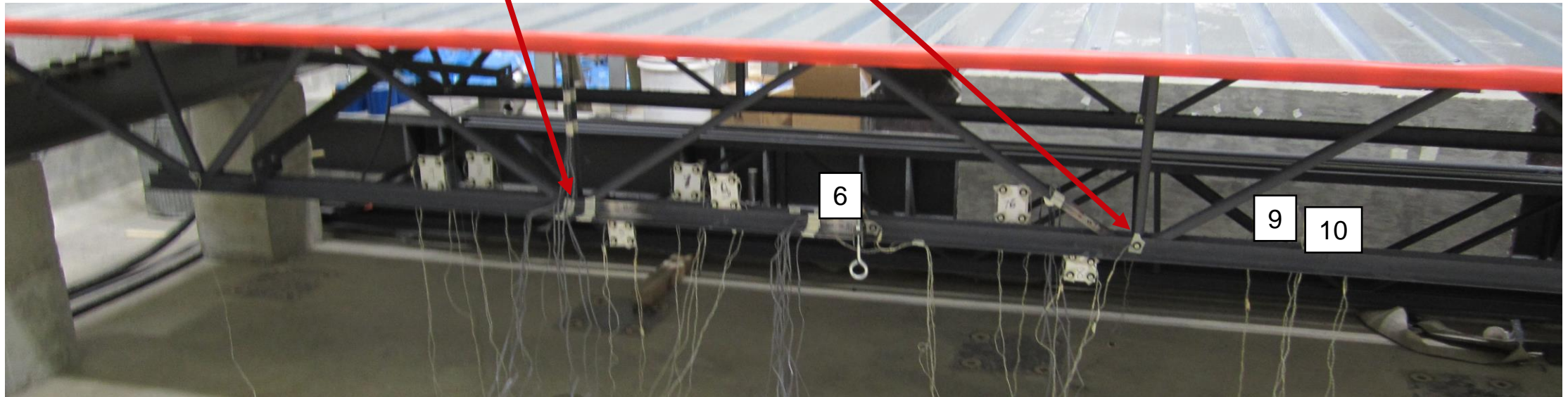
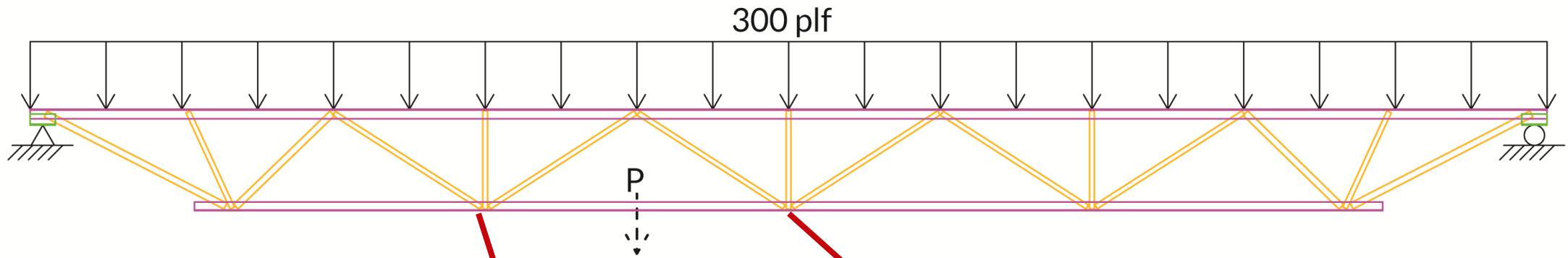

Result Diagrams – Scenario 1

- This section is all diagrams from Scenario 1.
- Force plots are shown with both the test results considering bimoment from warping and from ignoring the effects of warping.
- The stress plots are shown only with the case considering bimoment since at the locations checked the values were small.
 - At the top of each plot, the range of stresses is provided.
 - Stress diagrams have MASTAN2 results on top and Test results on bottom for a given loading. A label is provided underneath the x-axis as a reminder.
 - Diagrams are scaled in each vertical pair, but not across remaining diagrams.
 - Red is tension (+) and blue is compression (-)

Measured Global Displacements

Deflection near Loading

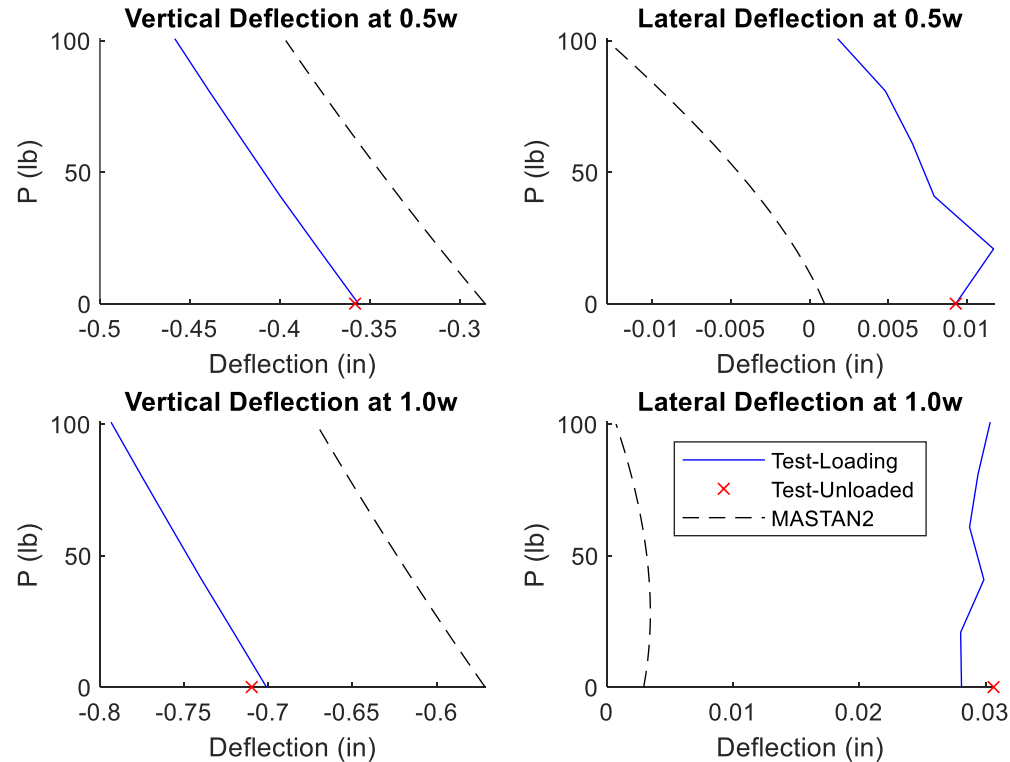

Deflection at Midspan Bottom Chord

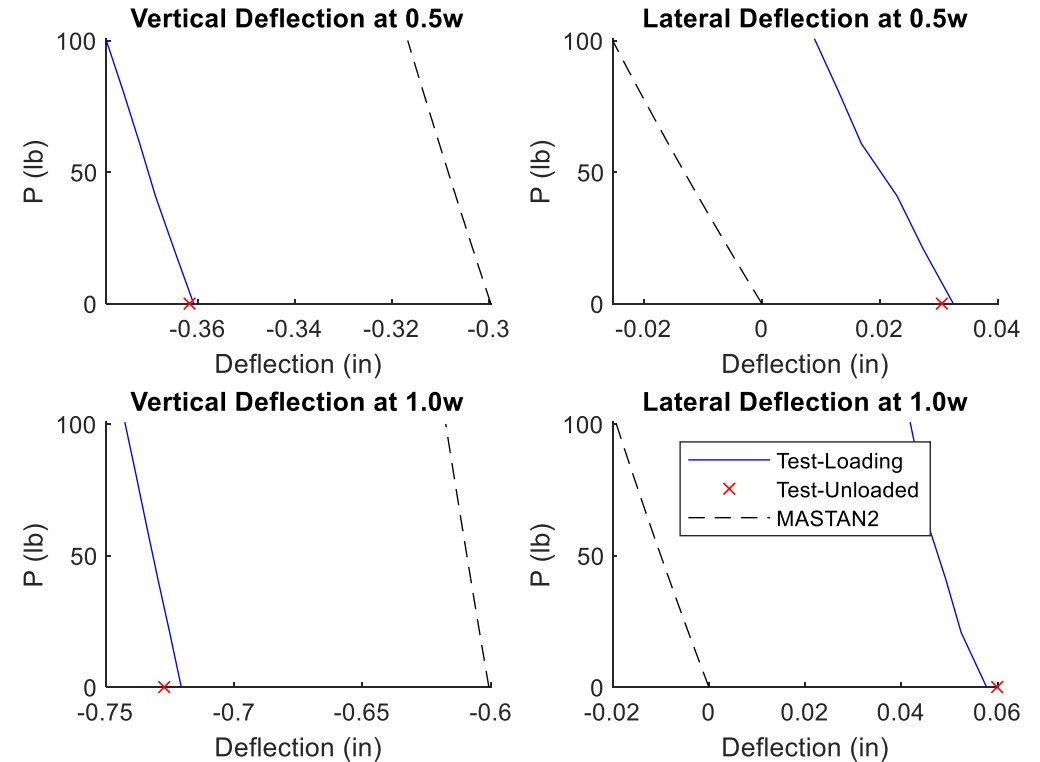

Measured Net Displacements

Net Deflection near Loading

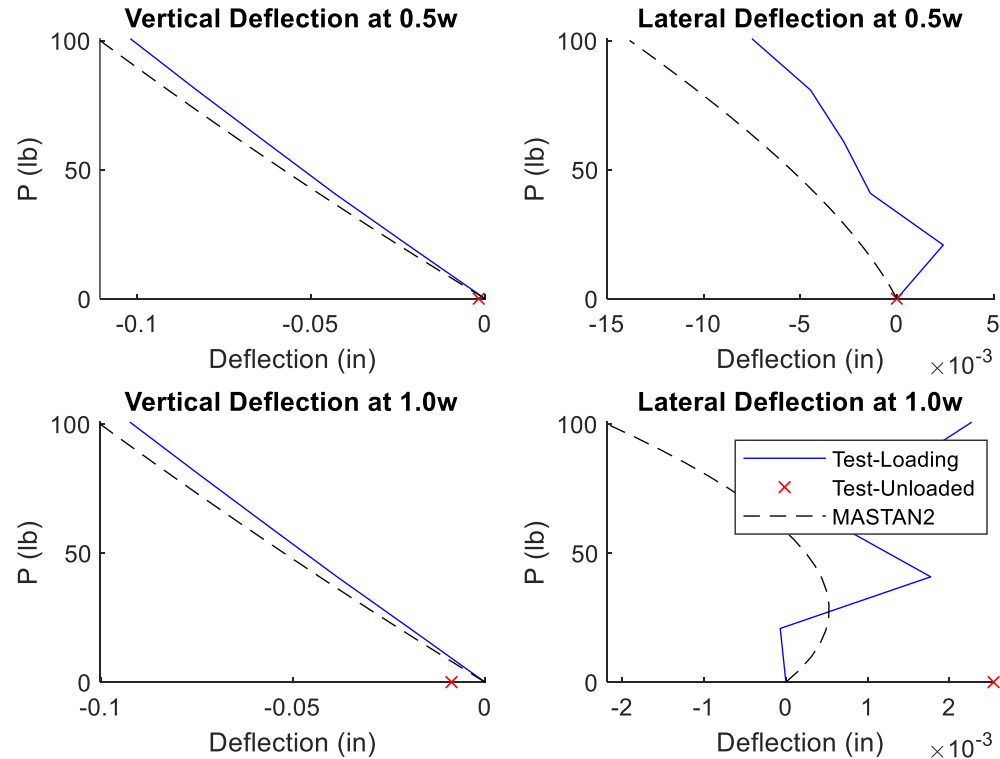

Net Deflection at Midspan Bottom Chord

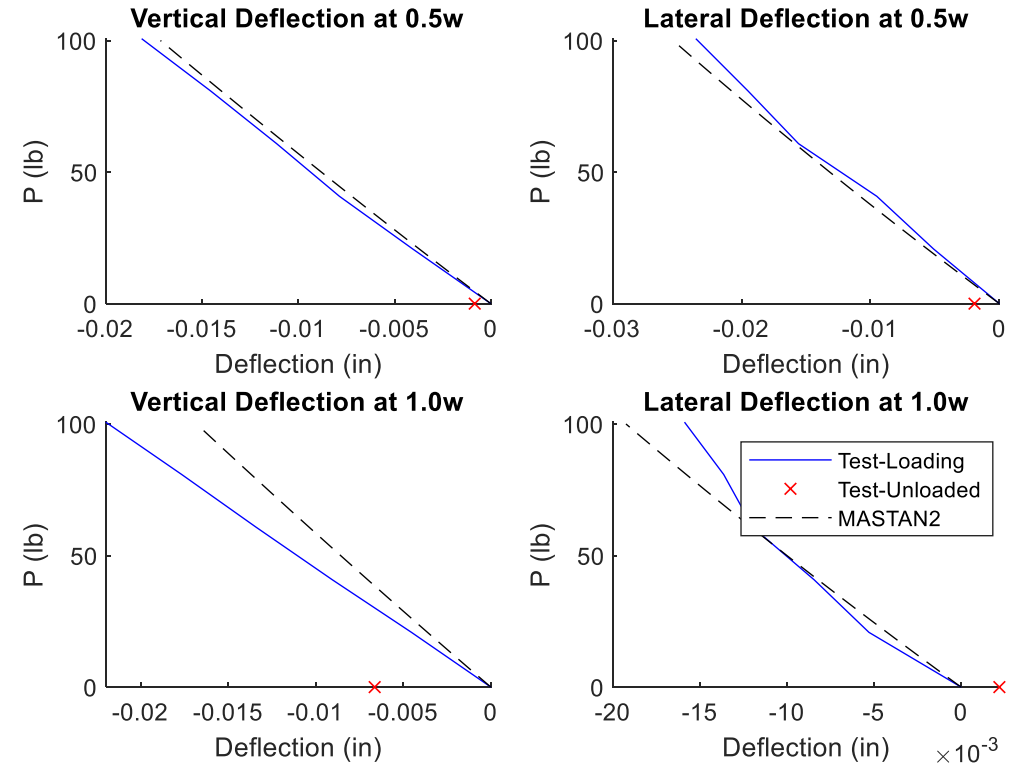

Measured Rotations

Loaded Member

Plate-6 Results

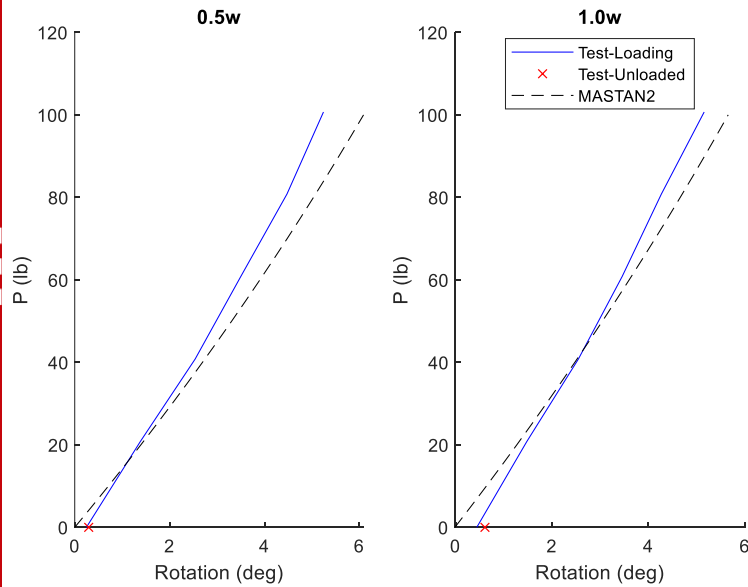

Unloaded Member

Plate-9 Results

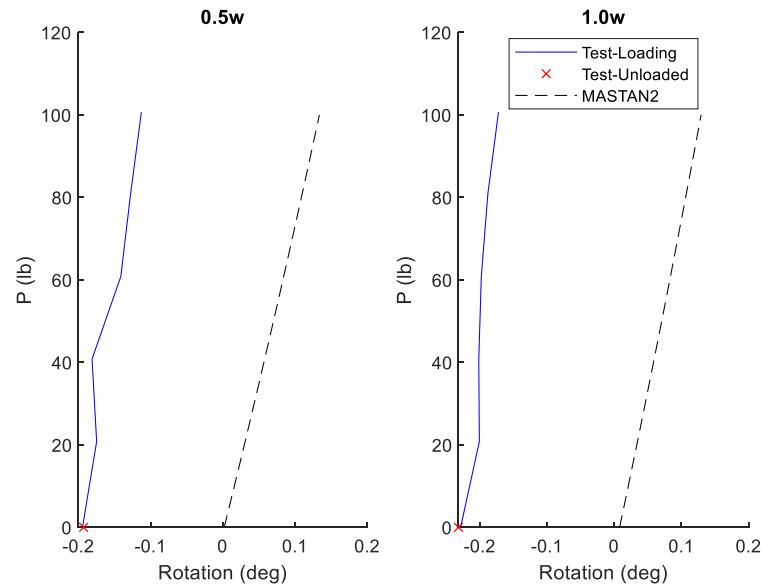

Loaded Member

Plate-10 Results

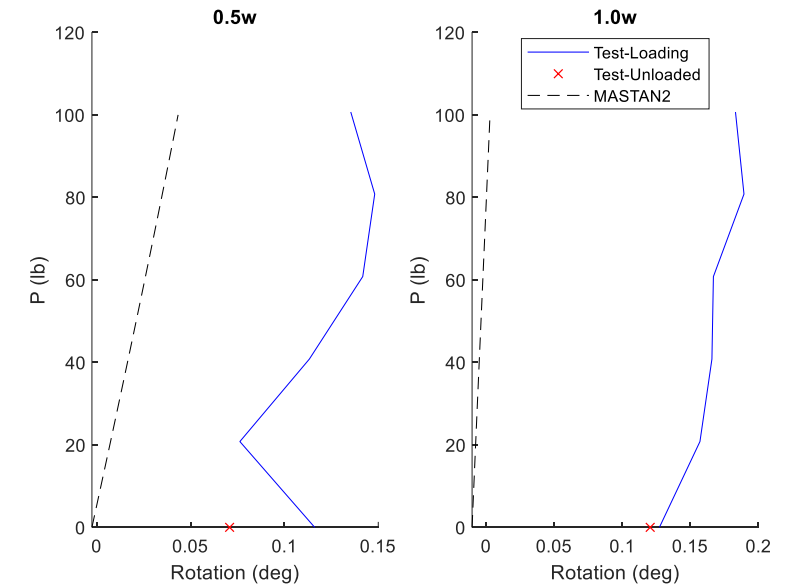

Measured Net Rotations

Loaded Member

Net Plate-6 Results

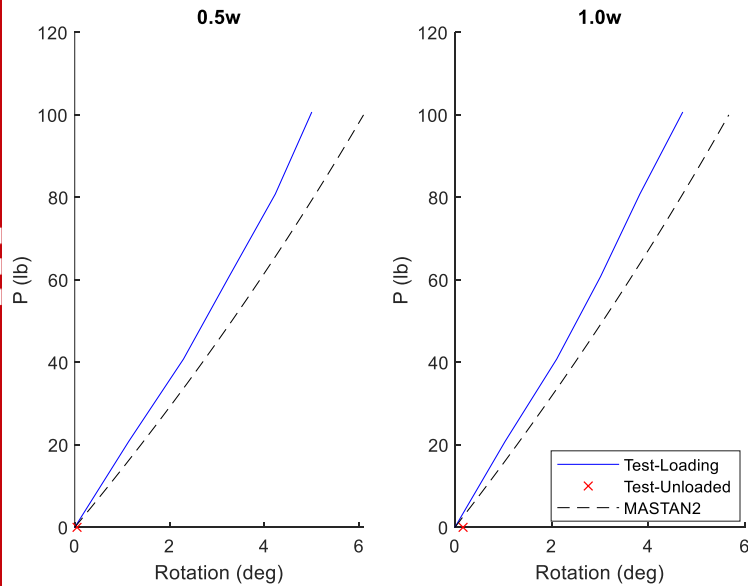

Unloaded Member

Net Plate-9 Results

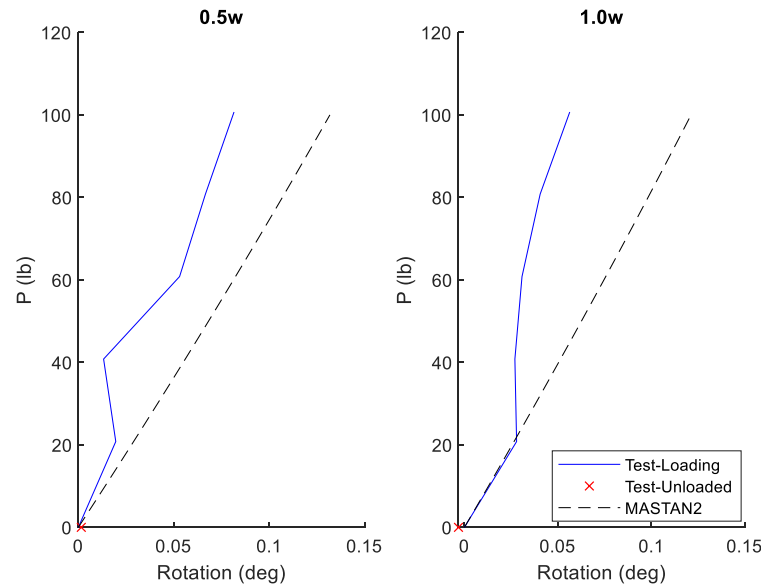

Loaded Member

Net Plate-10 Results

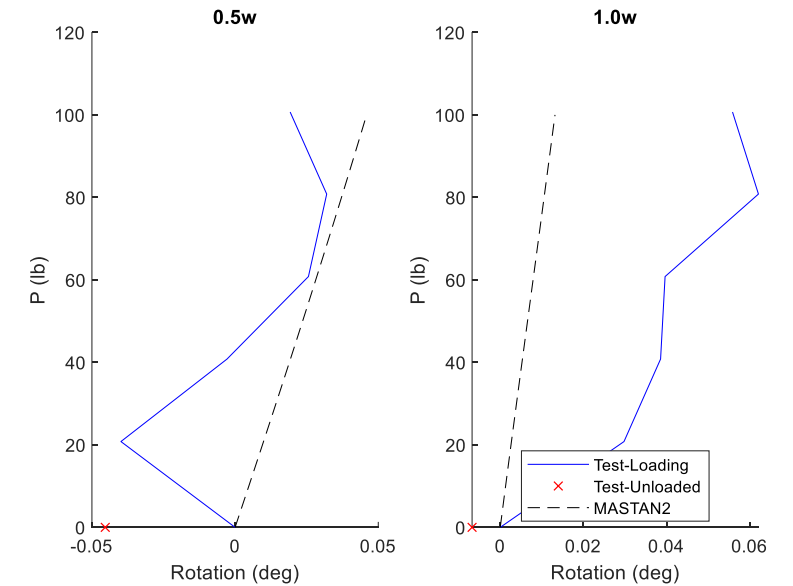

Force Comparisons

Position 3 Calculated Internal Forces

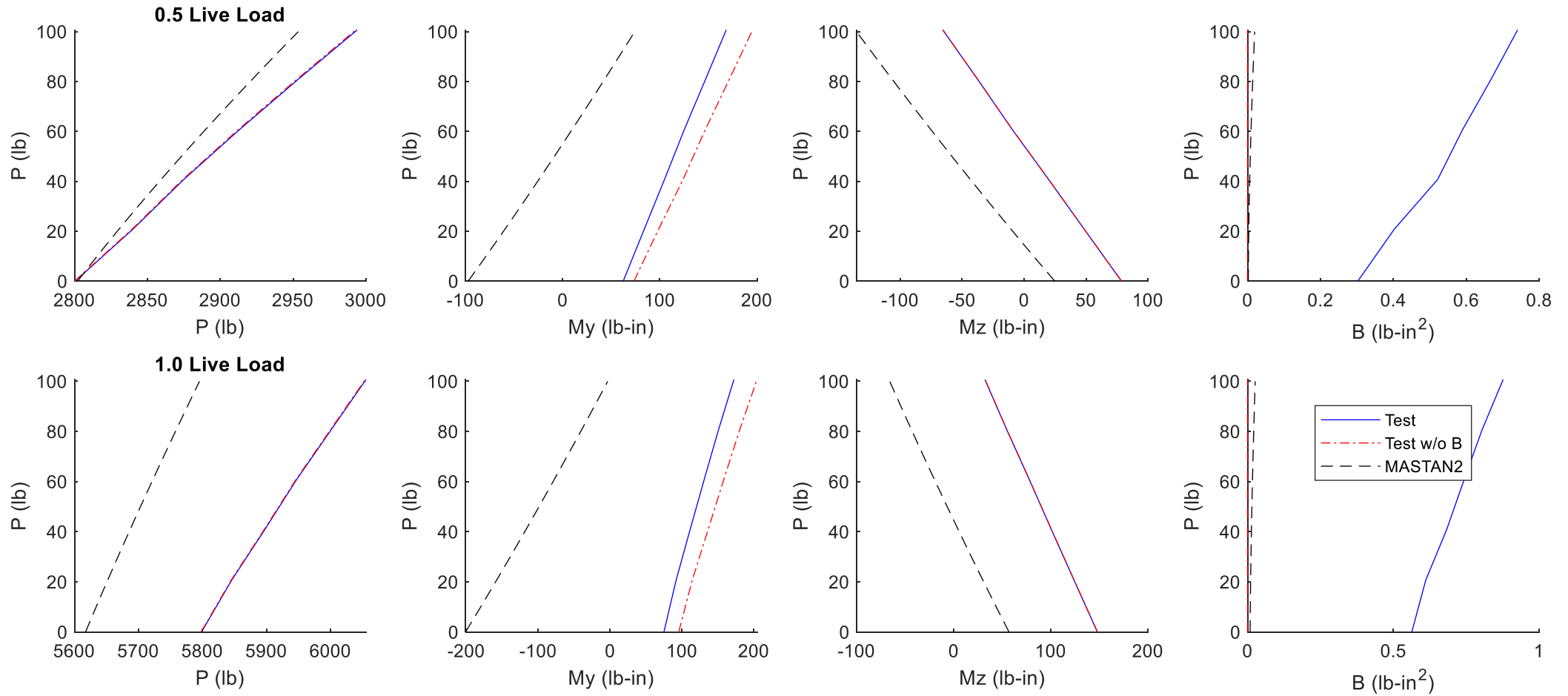

Force Comparisons

Position 4 Calculated Internal Forces

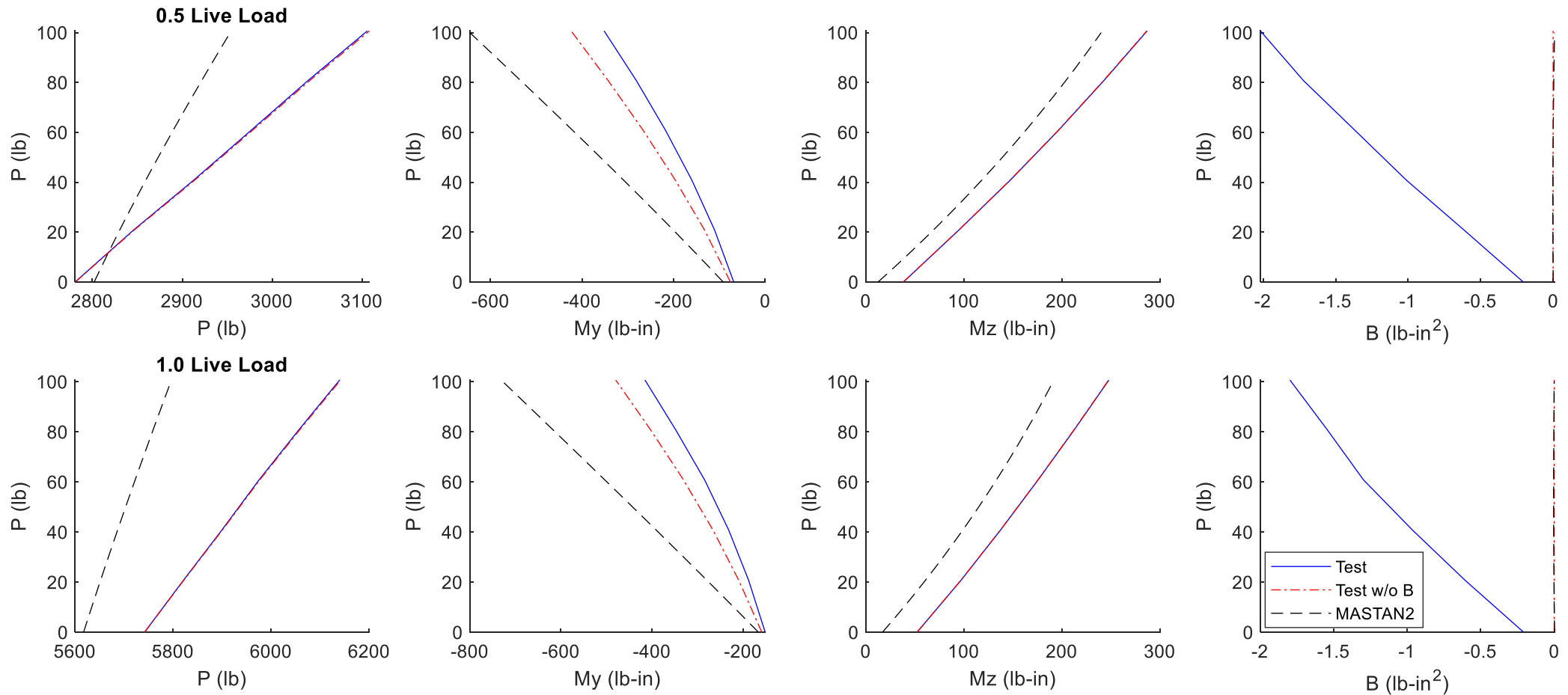

Force Comparisons

Position 5 Calculated Internal Forces

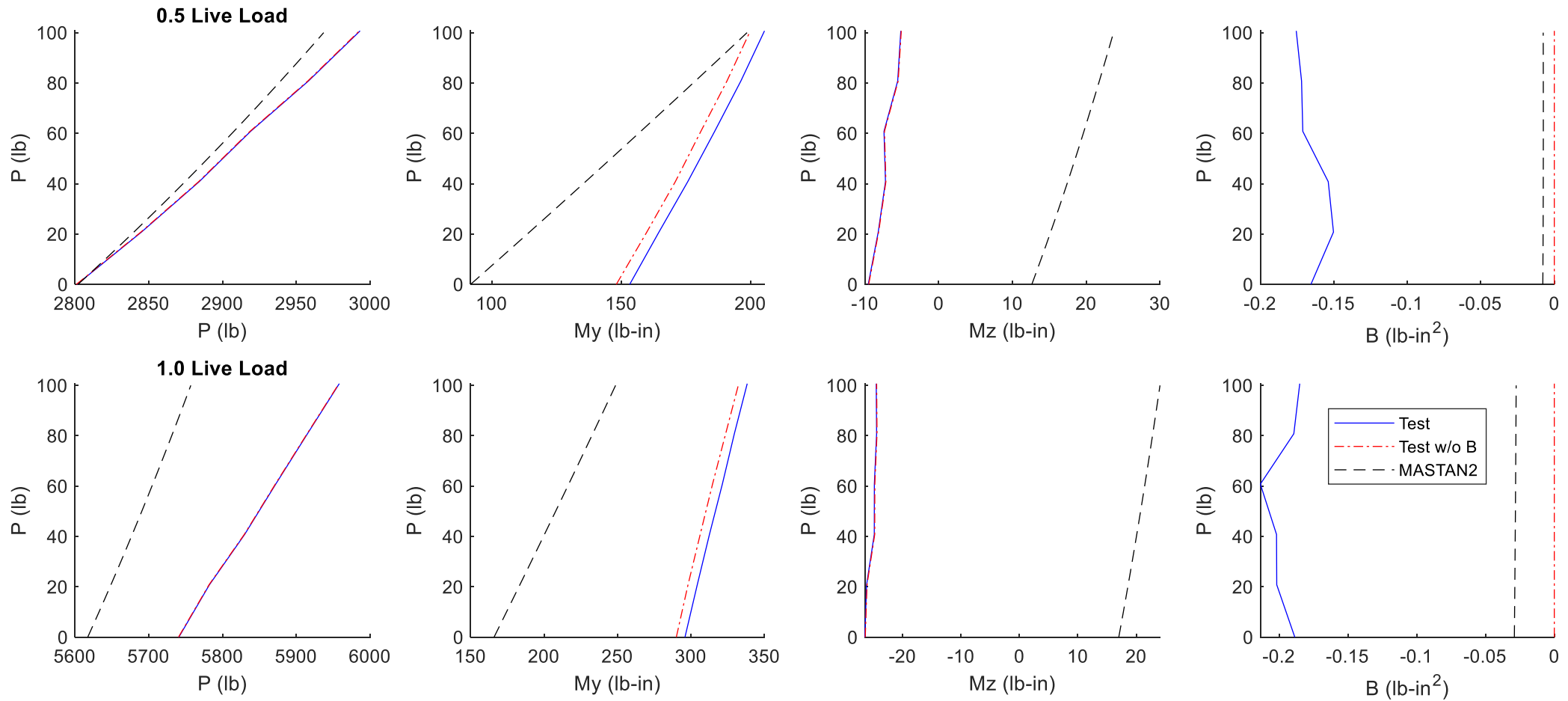

Net Force Comparisons

Position 3 Calculated Net Internal Forces

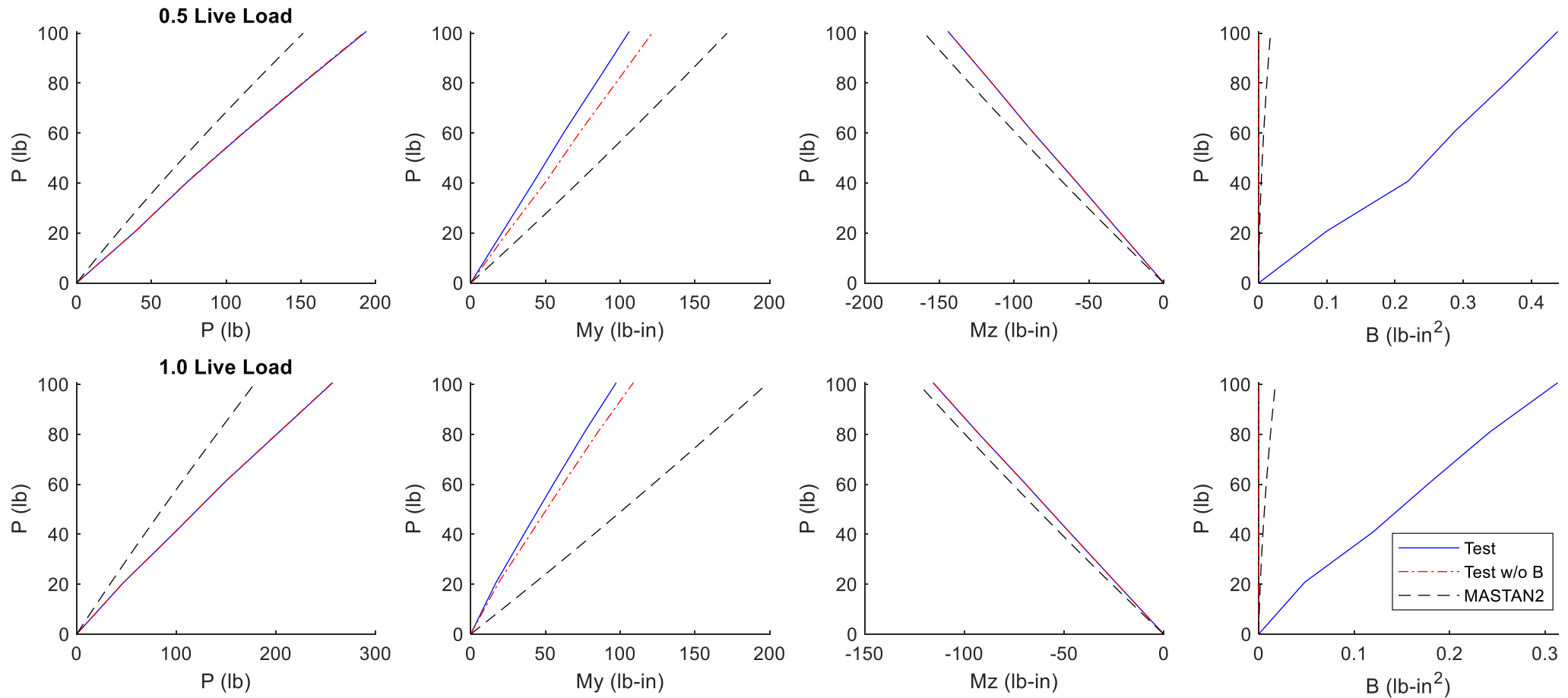

Net Force Comparisons

Position 4 Calculated Net Internal Forces

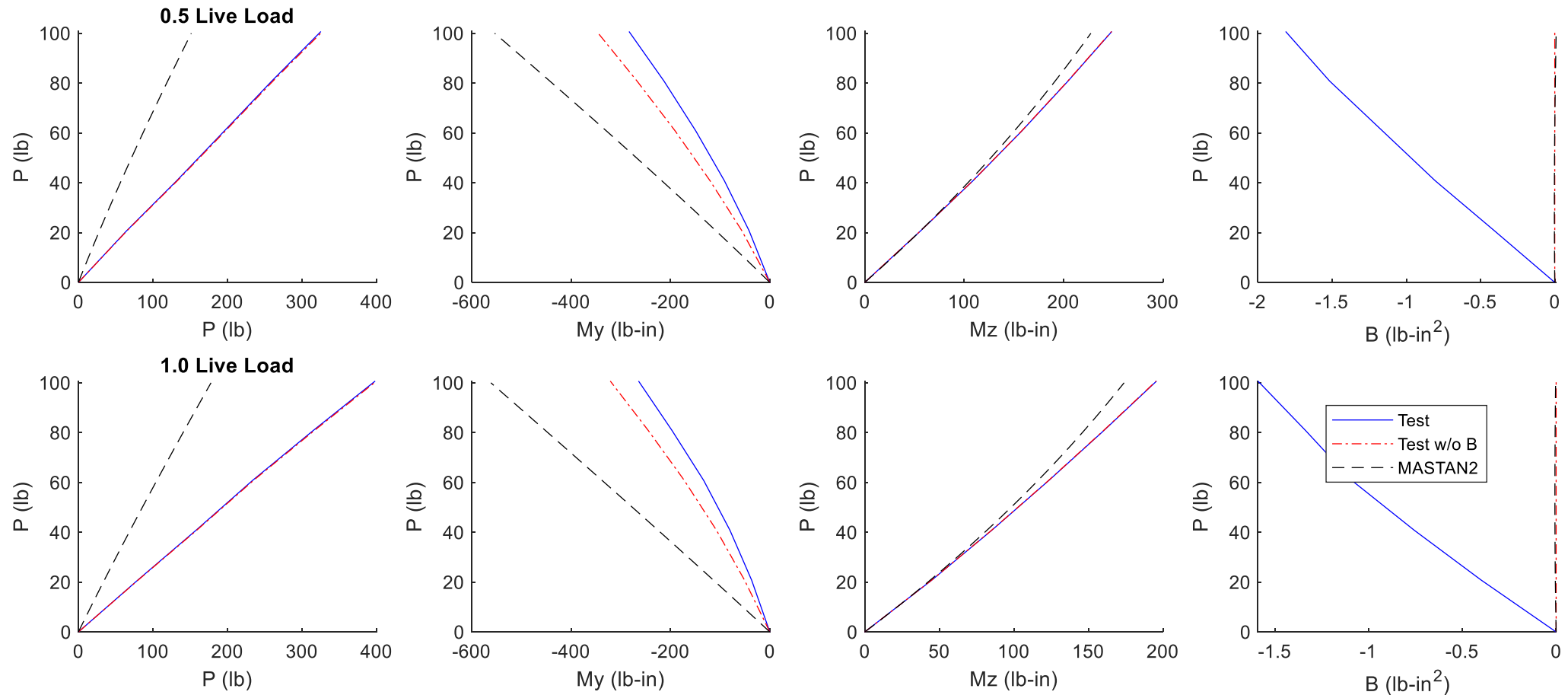

Net Force Comparisons

Position 5 Calculated Net Internal Forces

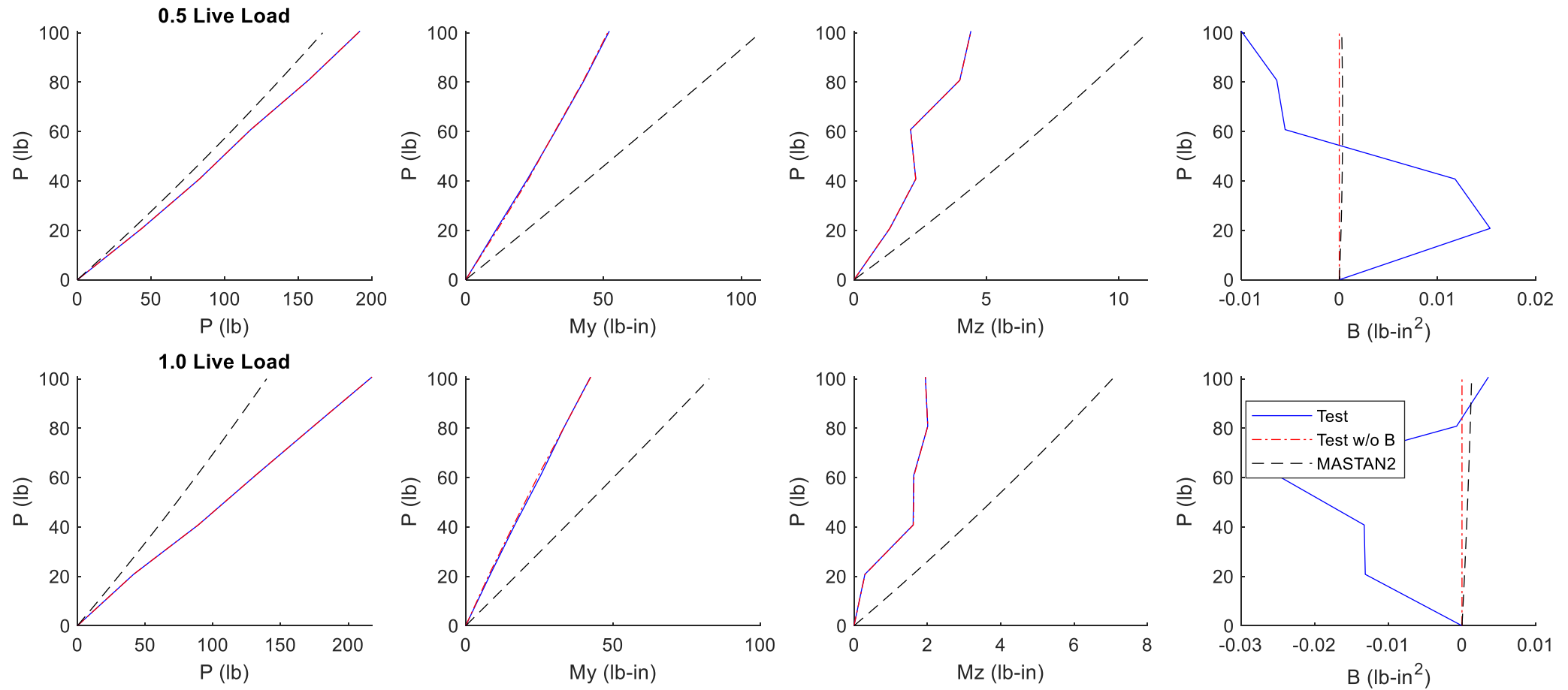

Stress Comparisons

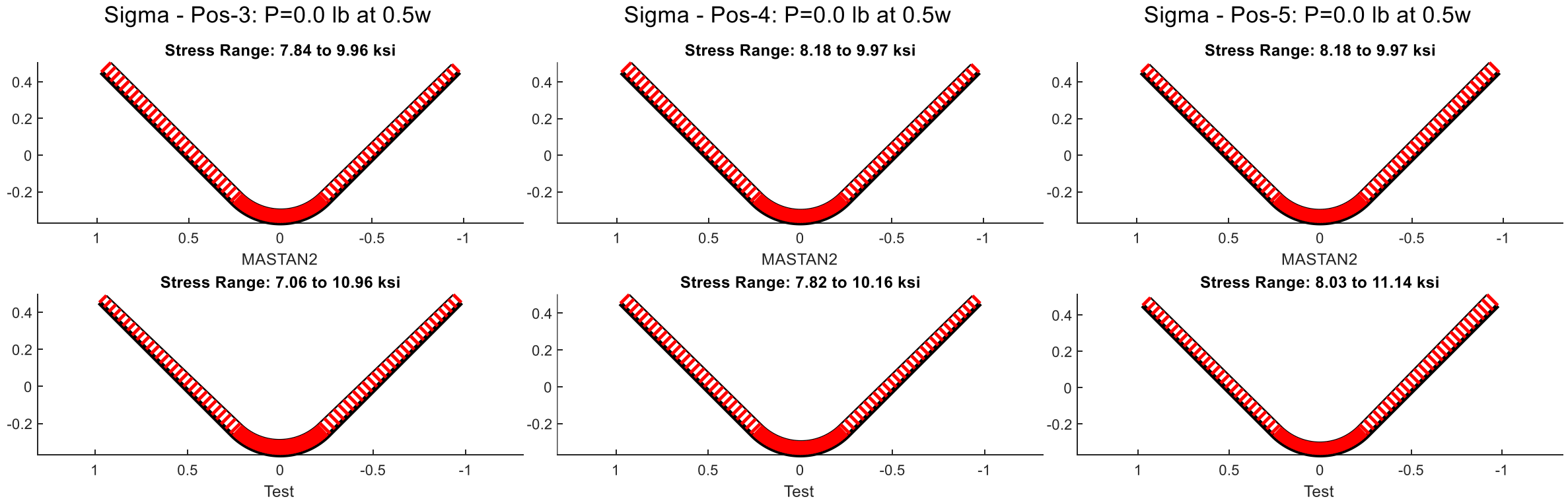

Stress Comparisons

Sigma - Pos-3: P=60.8 lb at 0.5w

Stress Range: 8.25 to 11.46 ksi

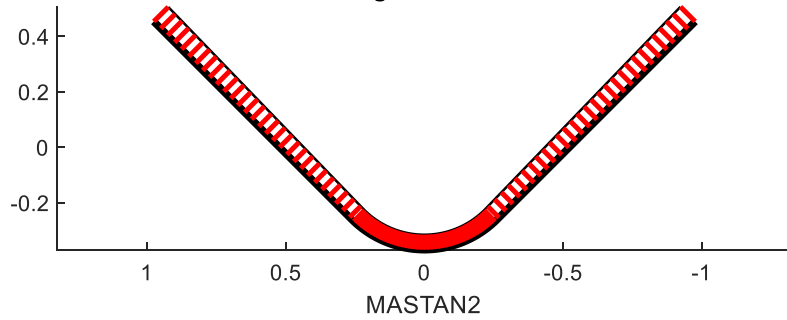

Sigma - Pos-4: P=60.8 lb at 0.5w

Stress Range: 1.86 to 13.08 ksi

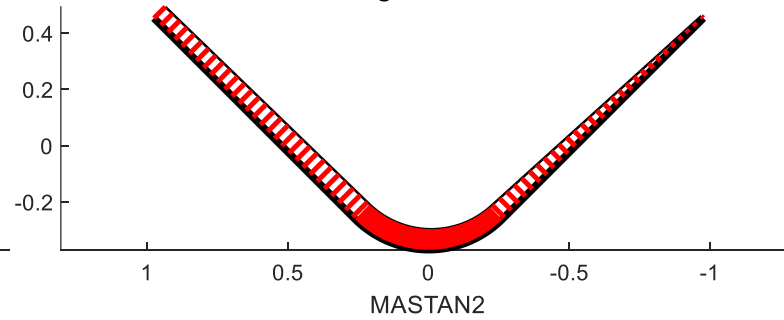

Sigma - Pos-5: P=60.8 lb at 0.5w

Stress Range: 7.73 to 10.79 ksi

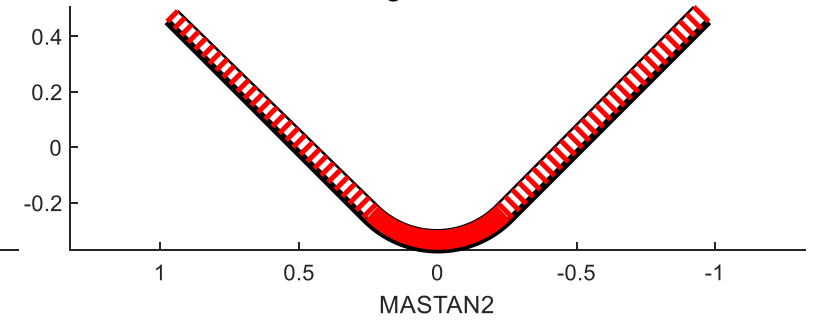

Stress Range: 8.96 to 10.93 ksi

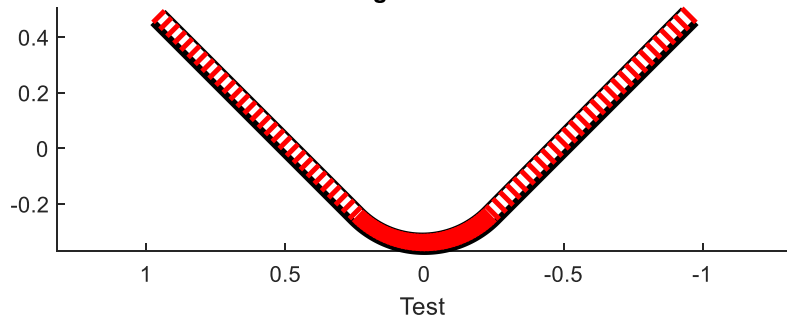

Stress Range: 3.84 to 14.31 ksi

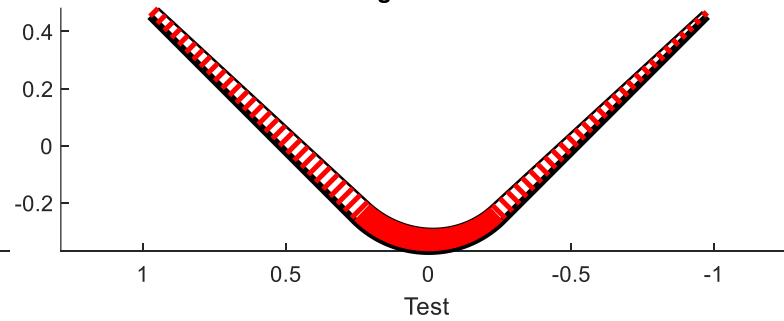

Stress Range: 8.05 to 11.81 ksi

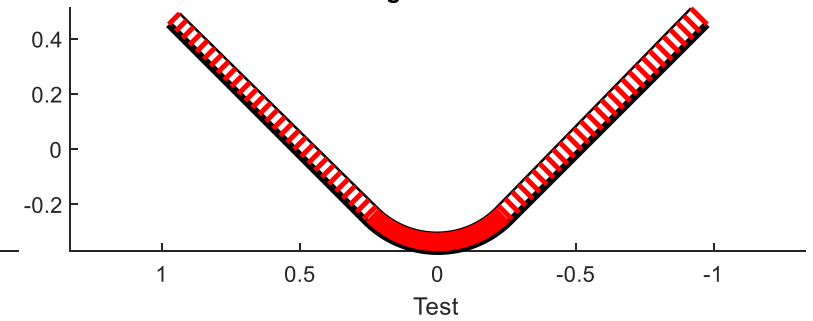

Stress Comparisons

Sigma - Pos-3: P=100.7 lb at 0.5w

Stress Range: 7.29 to 13.73 ksi

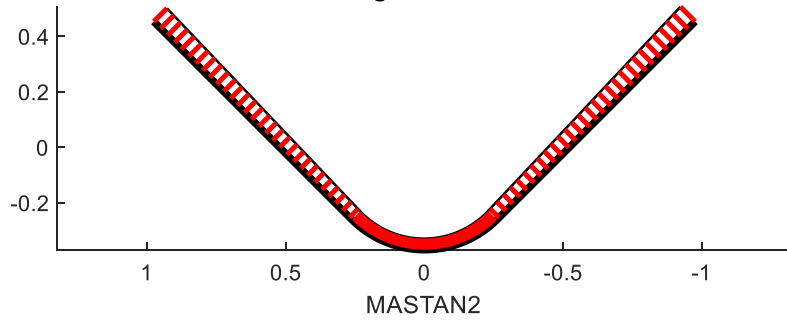

Sigma - Pos-4: P=100.7 lb at 0.5w

Stress Range: -1.98 to 15.01 ksi

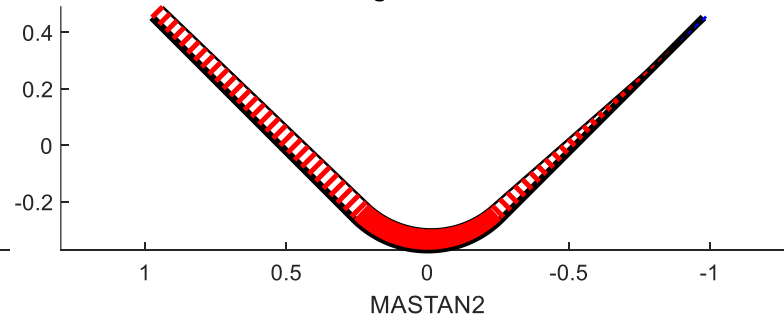

Sigma - Pos-5: P=100.7 lb at 0.5w

Stress Range: 7.44 to 11.30 ksi

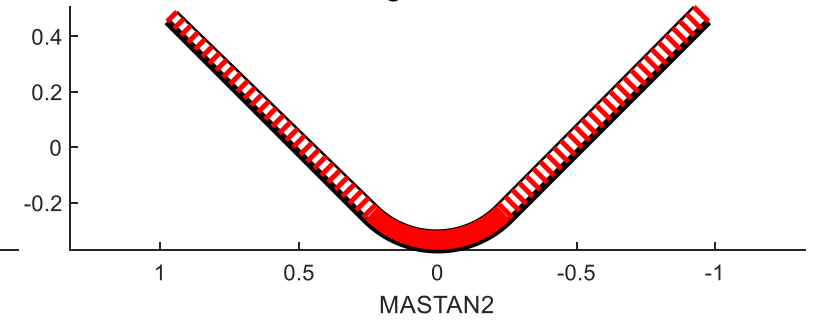

Stress Range: 8.22 to 12.86 ksi

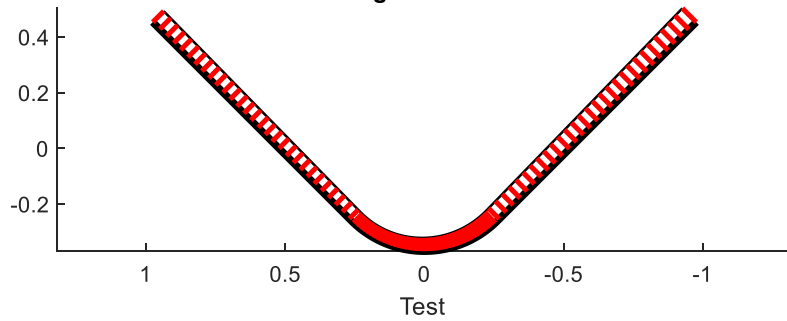

Stress Range: 1.14 to 16.81 ksi

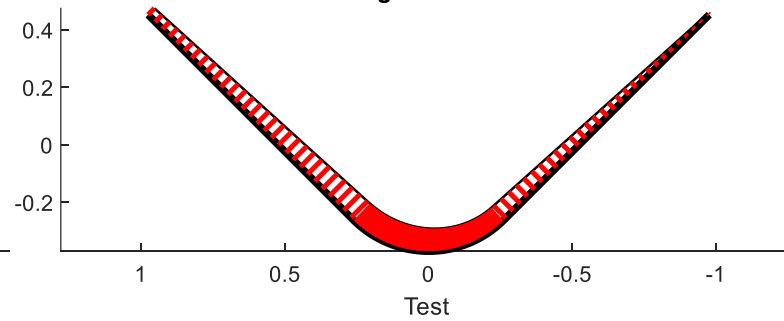

Stress Range: 8.06 to 12.19 ksi

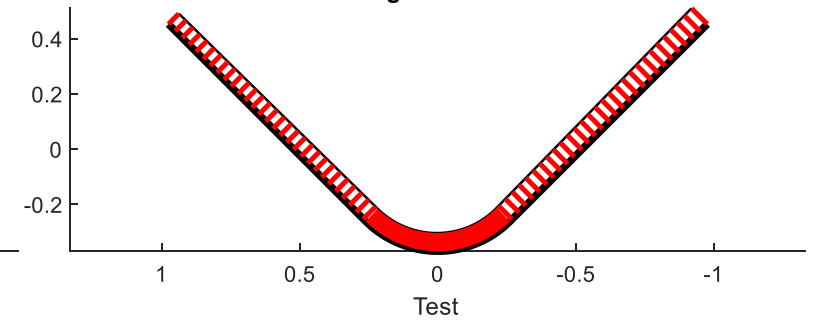

Stress Comparisons

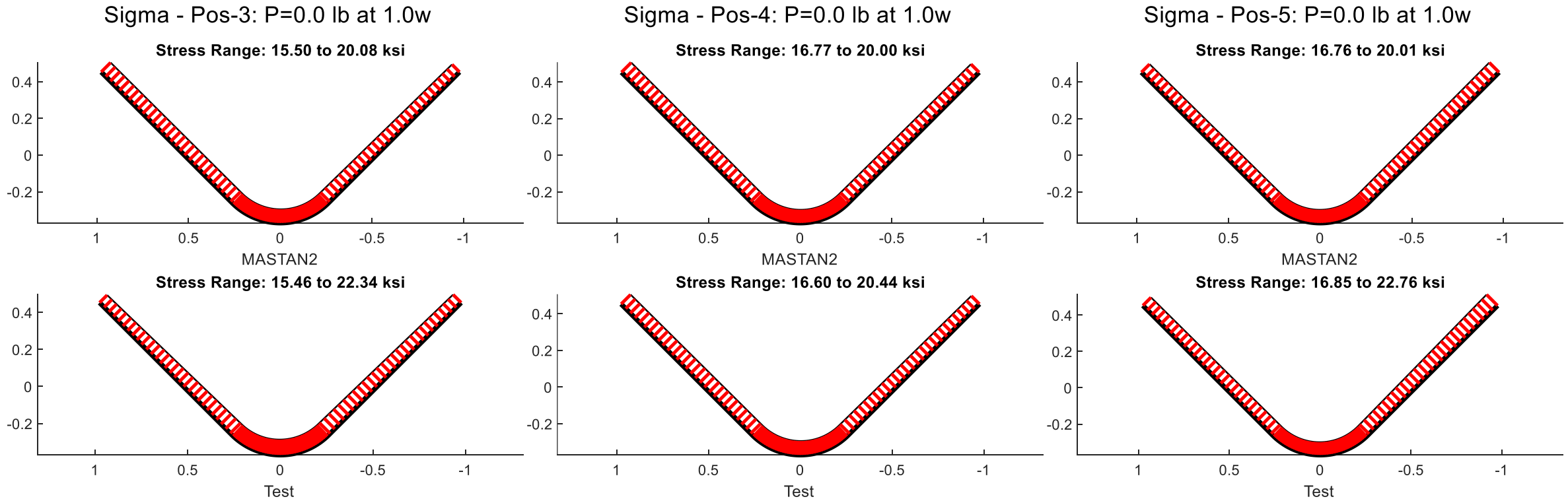

Stress Comparisons

Sigma - Pos-3: P=60.8 lb at 1.0w

Stress Range: 18.67 to 20.34 ksi

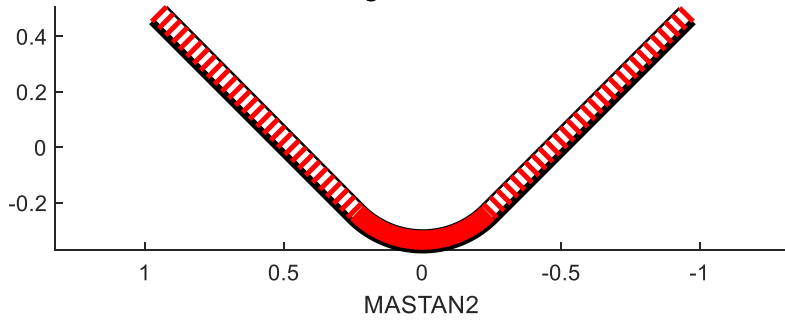

Sigma - Pos-4: P=60.8 lb at 1.0w

Stress Range: 11.21 to 22.23 ksi

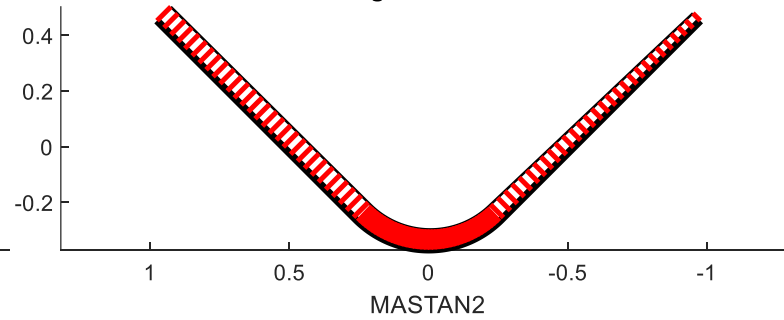

Sigma - Pos-5: P=60.8 lb at 1.0w

Stress Range: 16.46 to 20.68 ksi

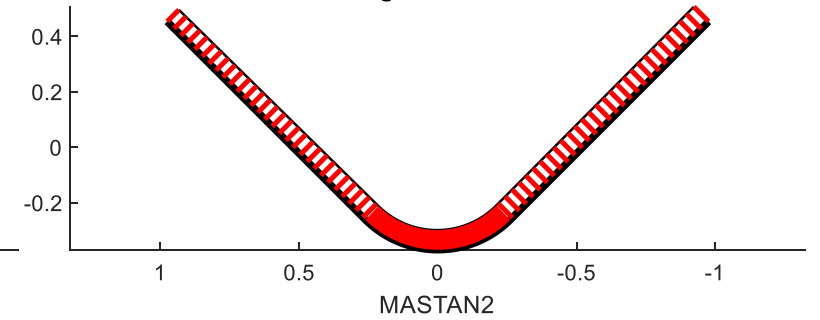

Stress Range: 17.11 to 21.79 ksi

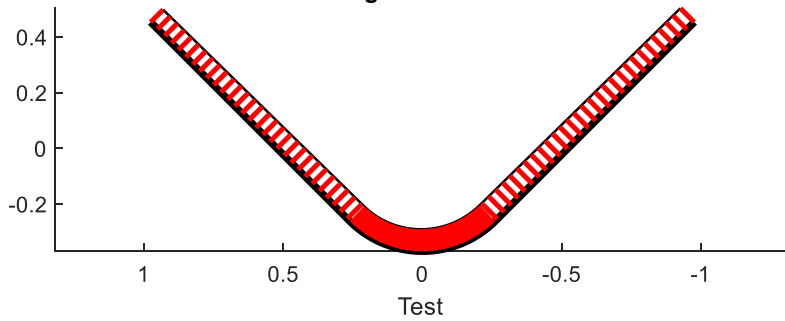

Stress Range: 13.67 to 24.06 ksi

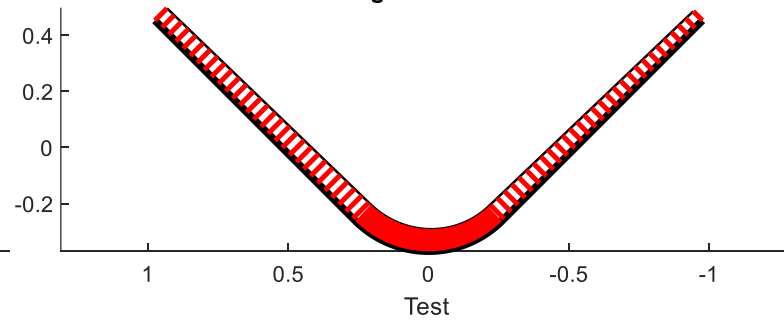

Stress Range: 17.00 to 23.42 ksi

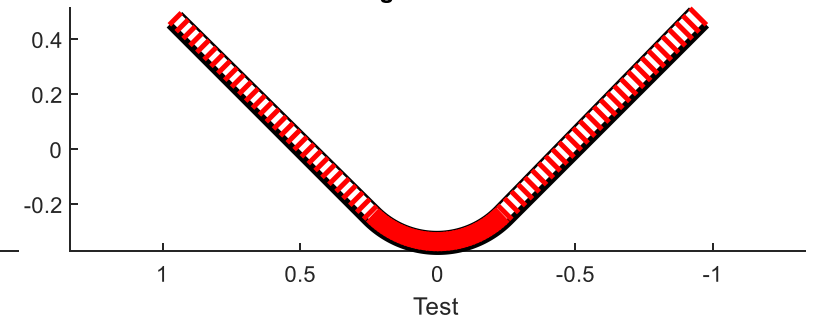

Stress Comparisons

Sigma - Pos-3: P=100.7 lb at 1.0w

Stress Range: 18.12 to 20.95 ksi

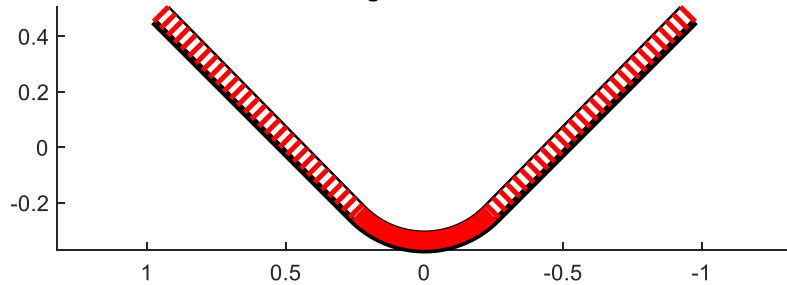

MASTAN2

Sigma - Pos-4: P=100.7 lb at 1.0w

Stress Range: 7.87 to 23.88 ksi

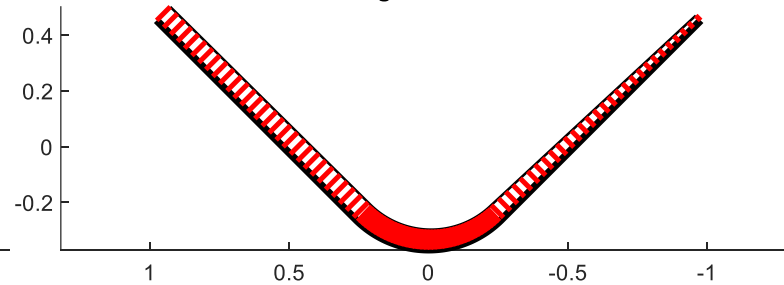

MASTAN2

Sigma - Pos-5: P=100.7 lb at 1.0w

Stress Range: 16.26 to 21.11 ksi

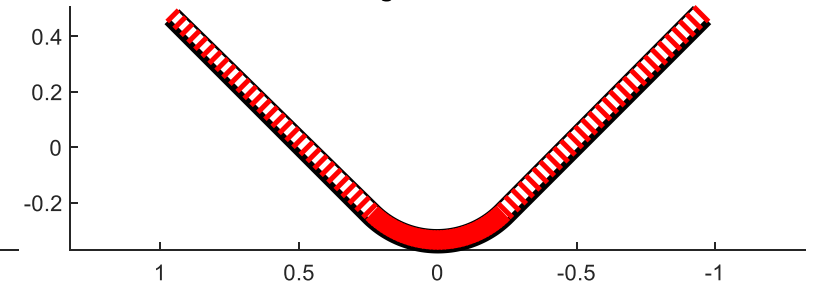

MASTAN2

Stress Range: 18.19 to 21.61 ksi

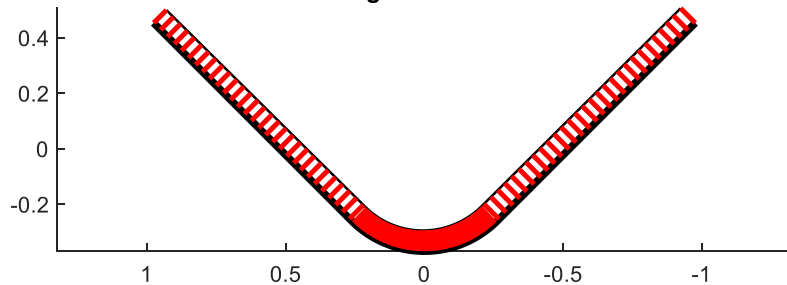

Test

Stress Range: 11.48 to 26.30 ksi

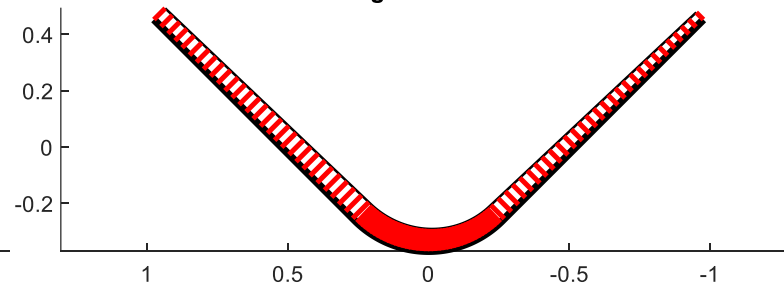

Test

Stress Range: 17.12 to 23.85 ksi

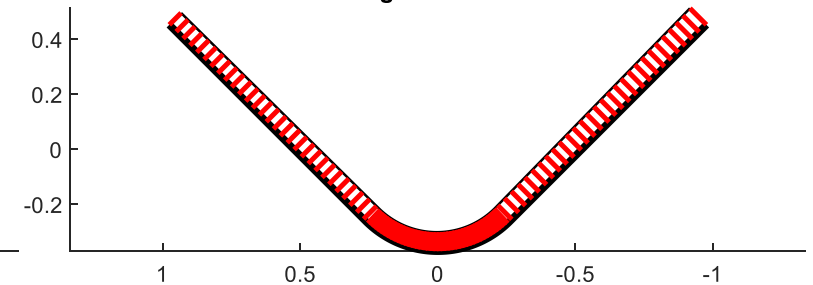

Test



Stress Comparisons

Net Sigma - Pos-3: P=60.8 lb at 0.5w

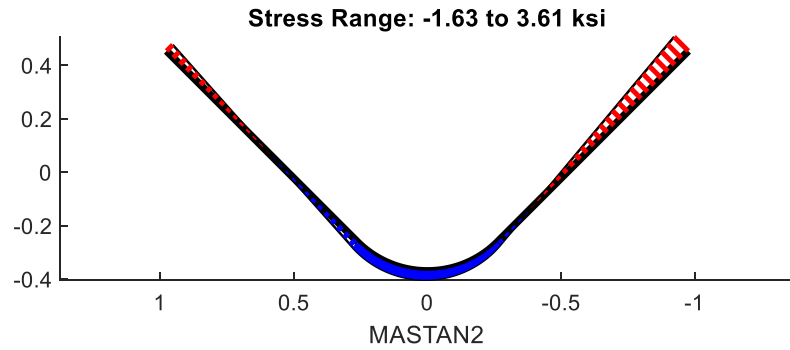

Net Sigma - Pos-4: P=60.8 lb at 0.5w

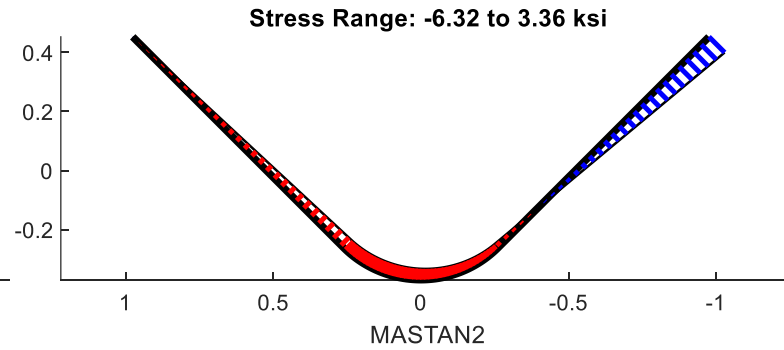

Net Sigma - Pos-5: P=60.8 lb at 0.5w

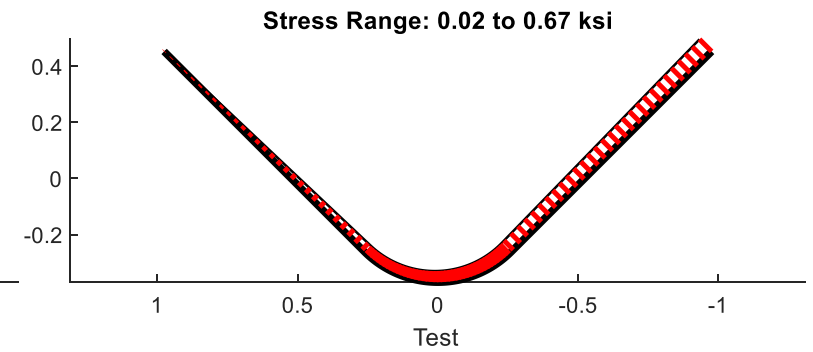
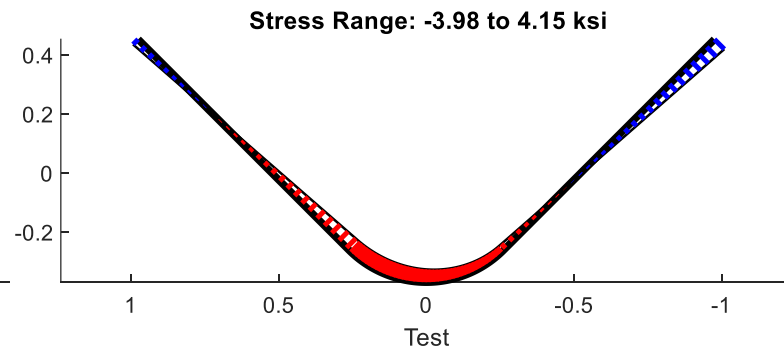
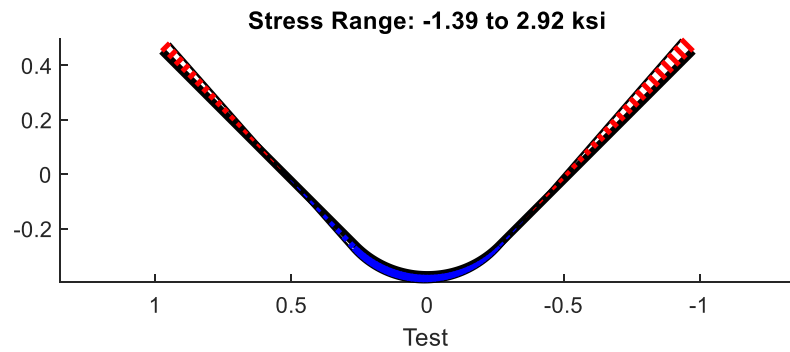
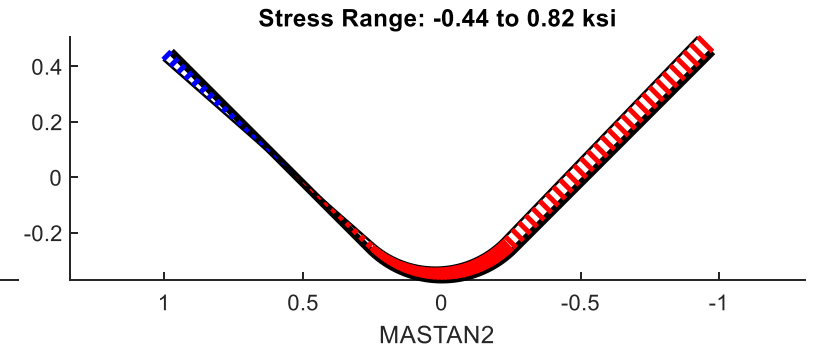

Stress Comparisons

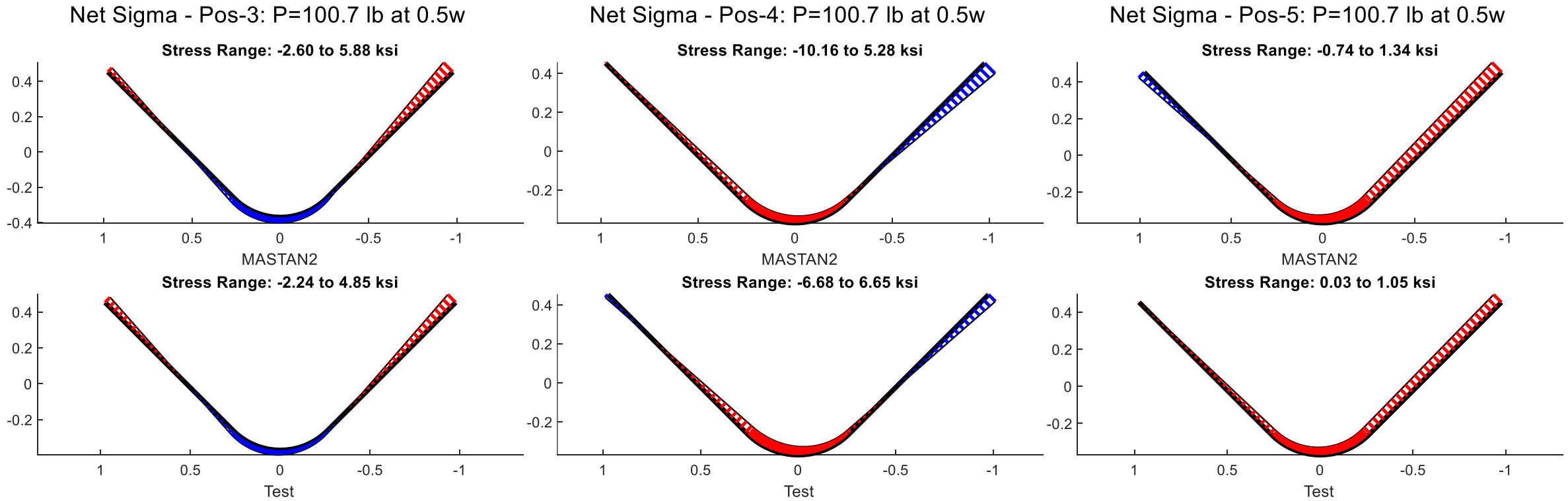

Stress Comparisons

Net Sigma - Pos-3: P=60.8 lb at 1.0w

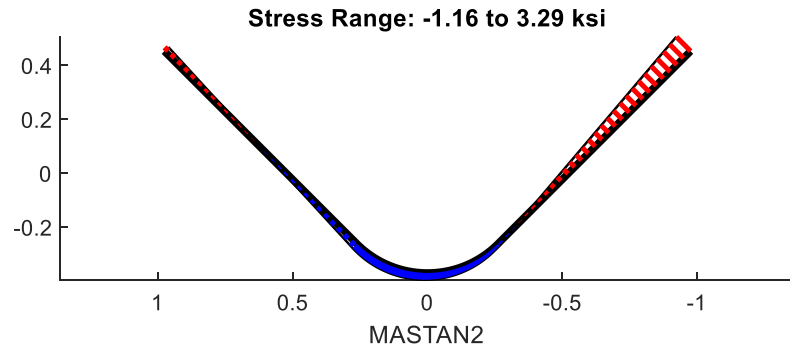

Net Sigma - Pos-4: P=60.8 lb at 1.0w

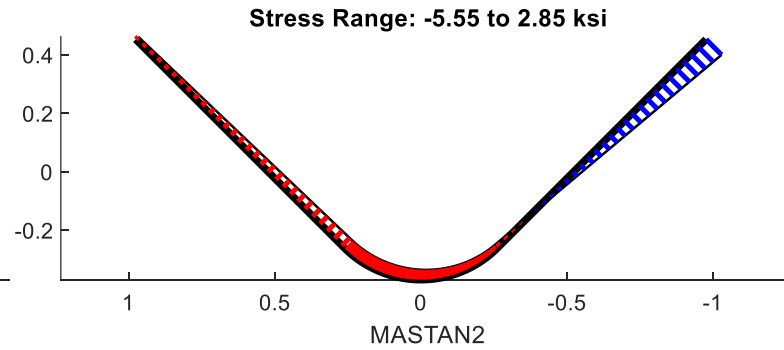

Net Sigma - Pos-5: P=60.8 lb at 1.0w

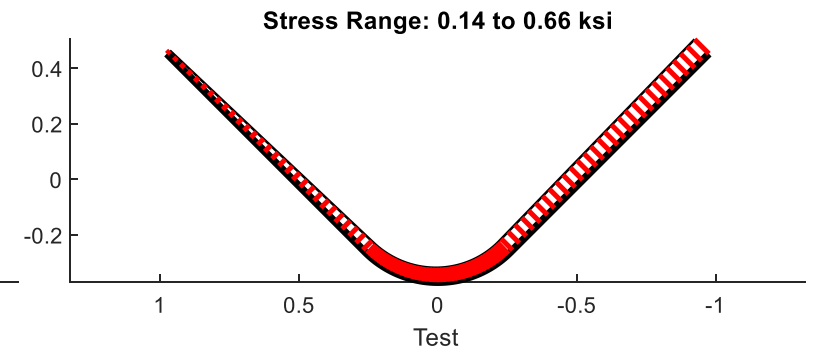
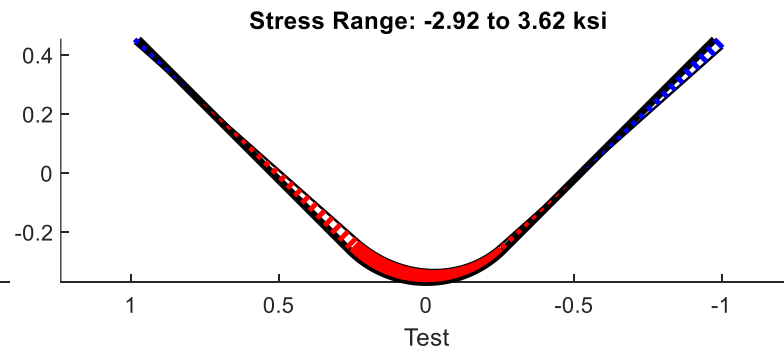
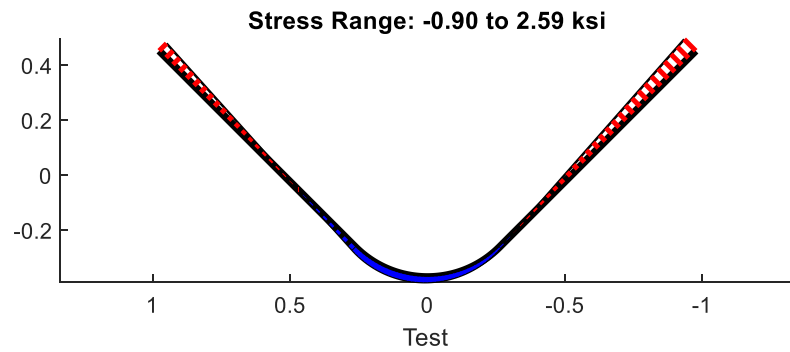
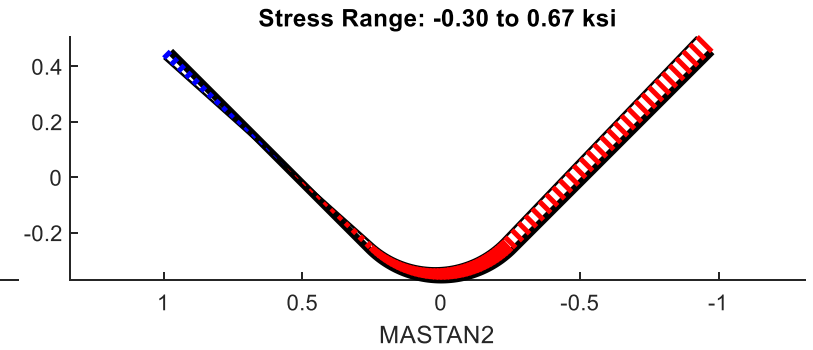

Stress Comparisons

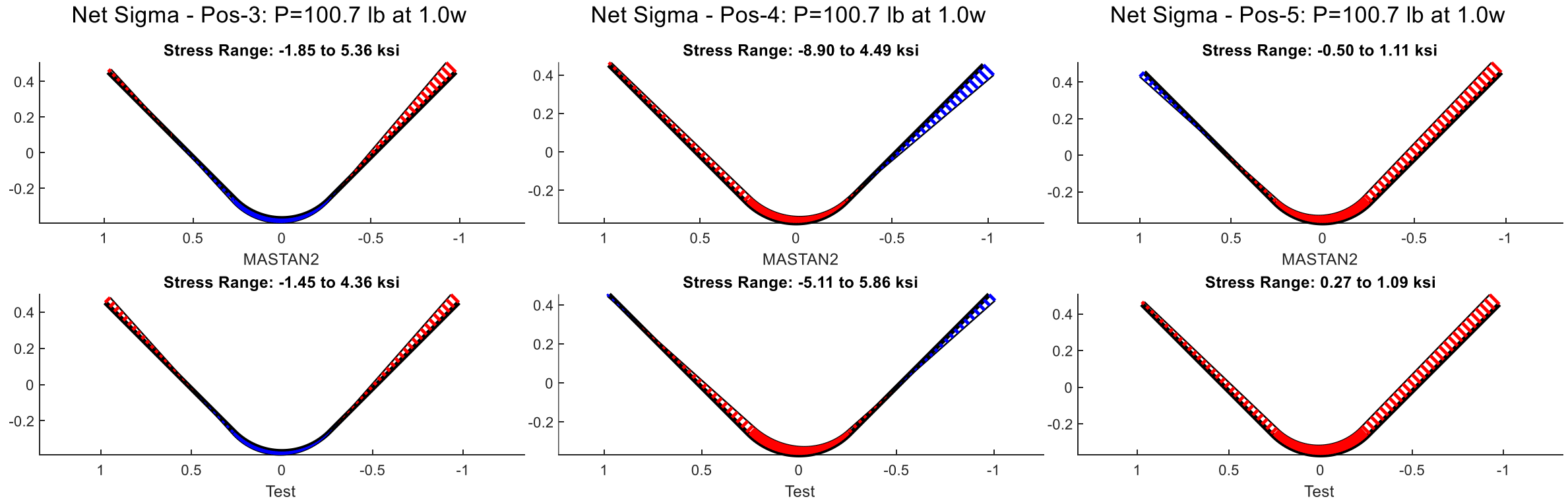

Result Diagrams – Scenario 2

- This section is all diagrams from Scenario 2.
- Force plots are shown with both the test results considering bimoment from warping and from ignoring the effects of warping.
- The stress plots are shown only with the case considering bimoment since at the locations checked the values were small.
 - Stress diagrams have MASTAN2 result on top and Test result on bottom for a given loading.
 - Diagrams are scaled in each vertical pair, but not across remaining calculations.
 - Red is tension (+) and blue is compression (-)

Measured Global Displacements

Deflection near Loading

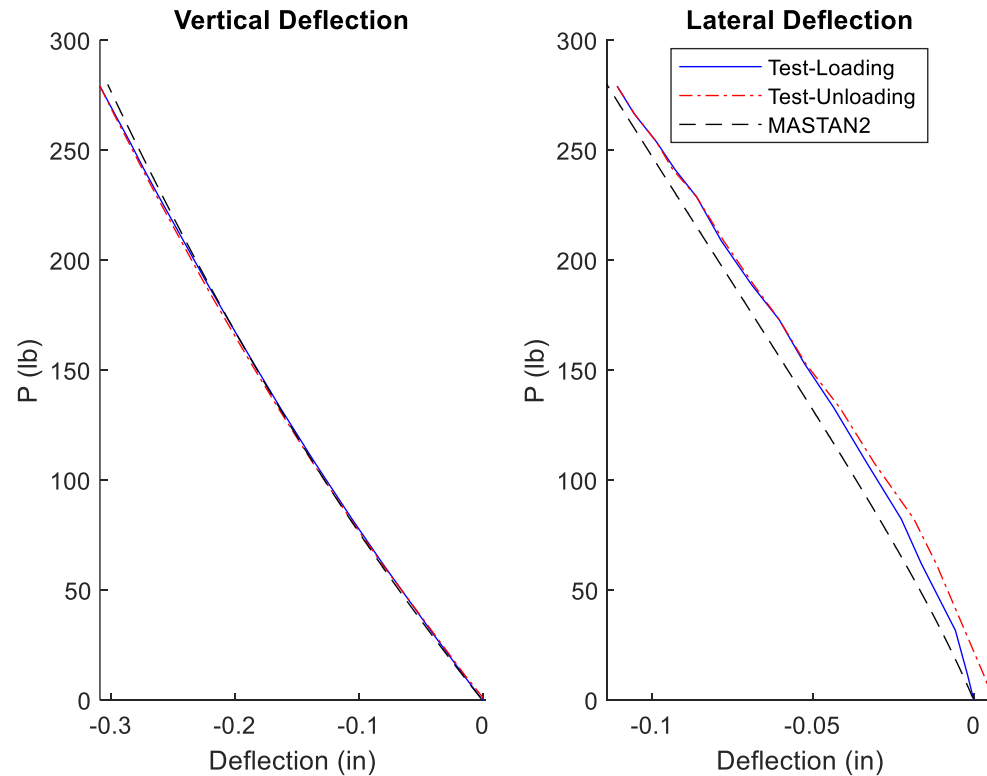

Deflection at Midspan Bottom Chord

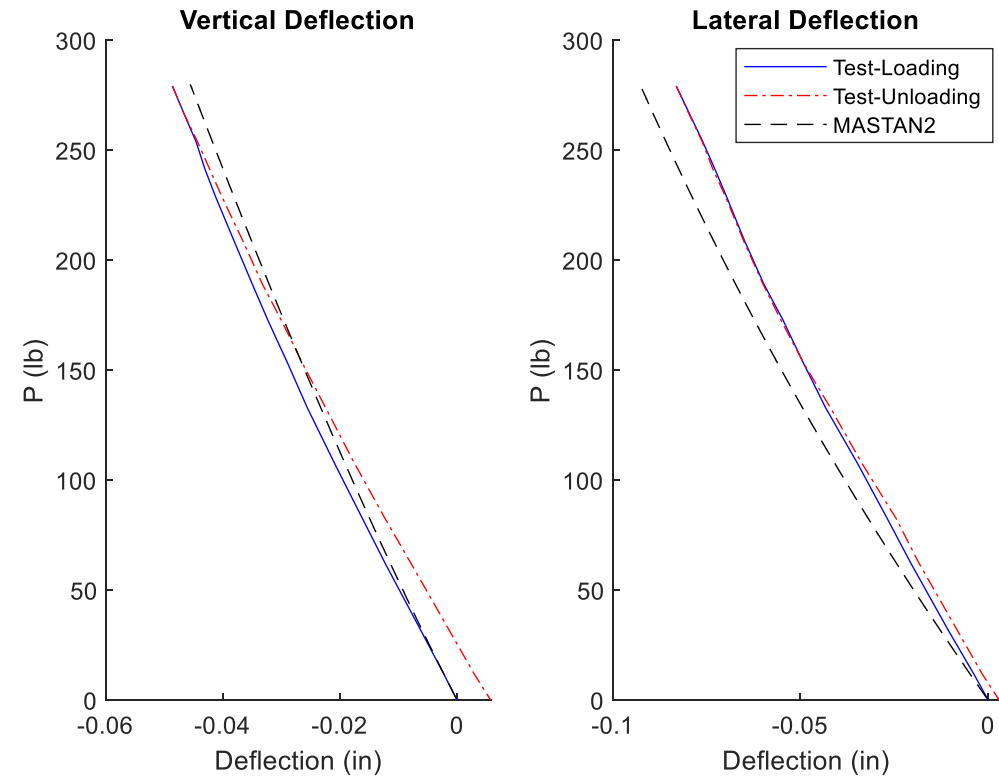

Measured Bottom Chord Twist

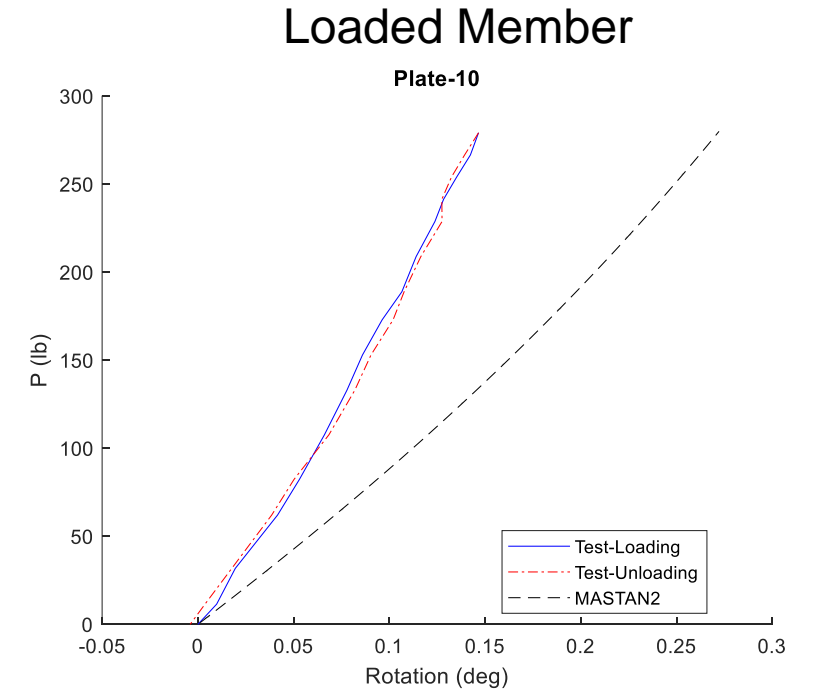
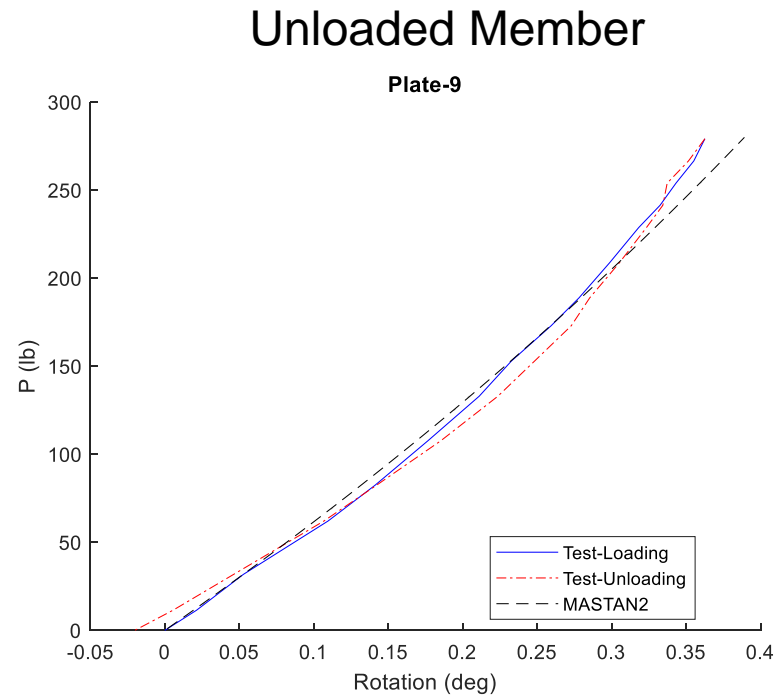
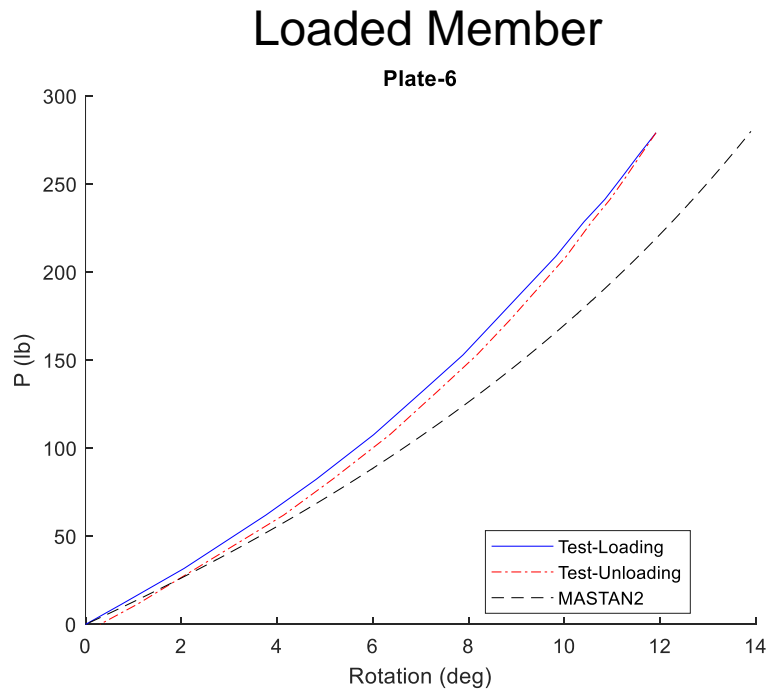

Force Comparisons

Position 3 Calculated Internal Forces

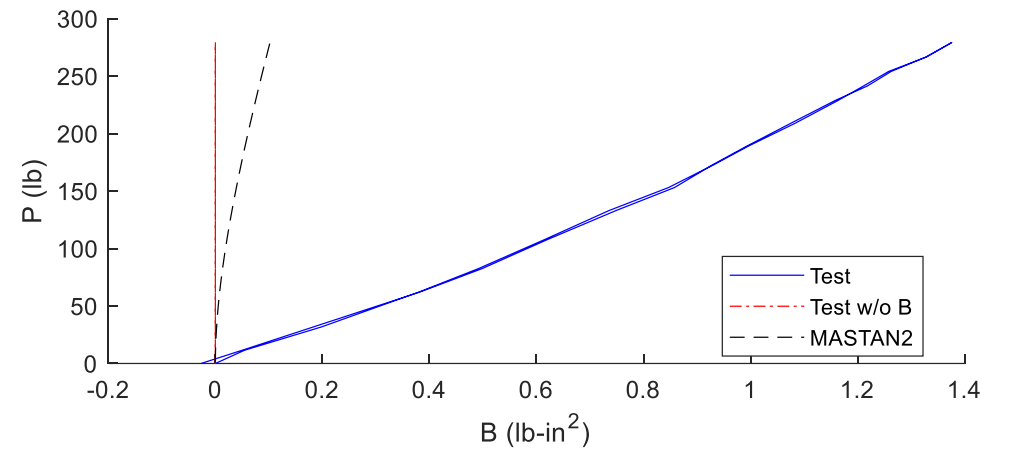
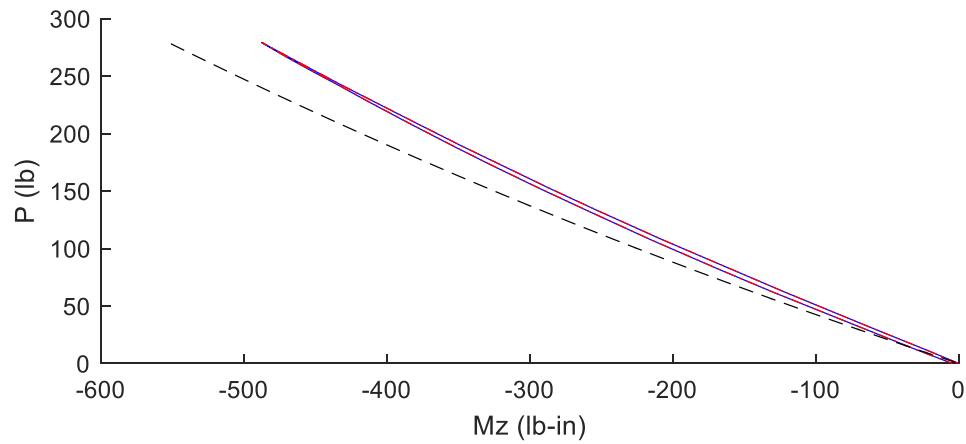
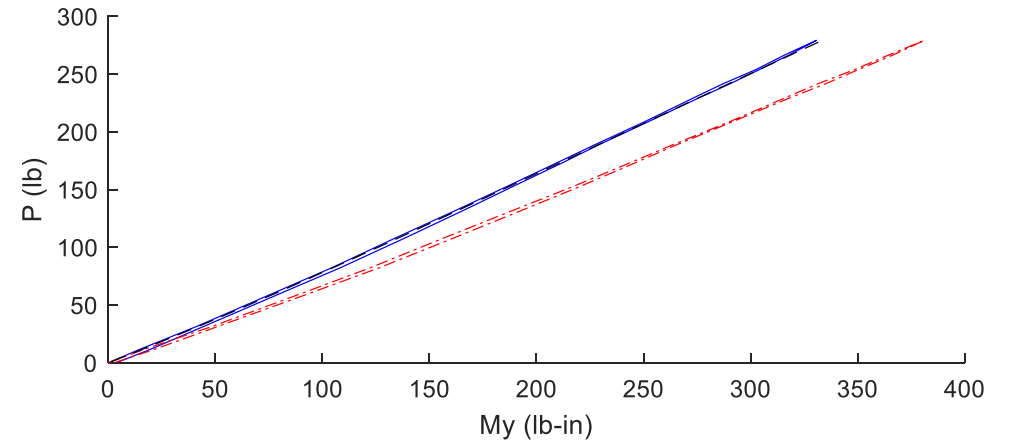
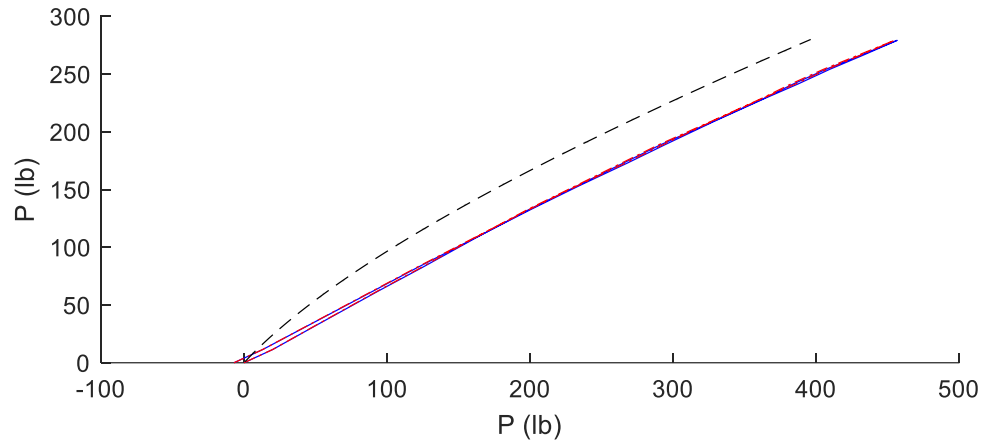

Force Comparisons

Position 4 Calculated Internal Forces

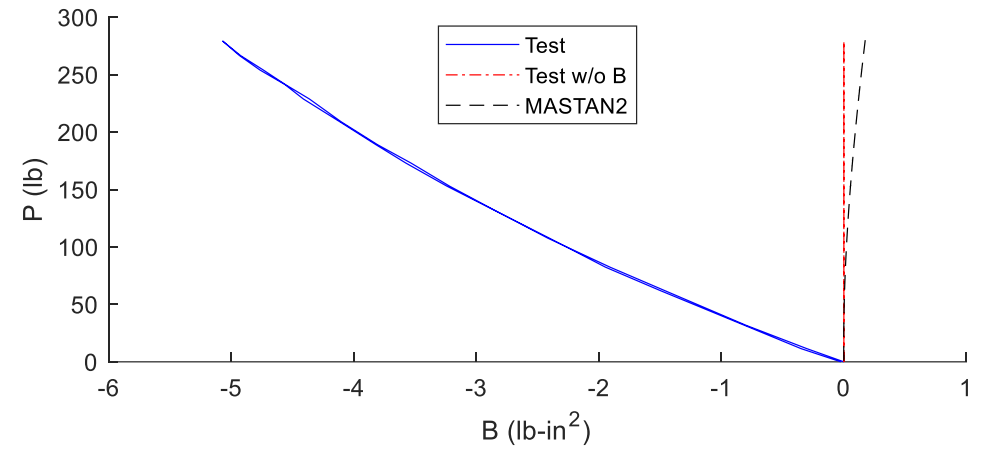
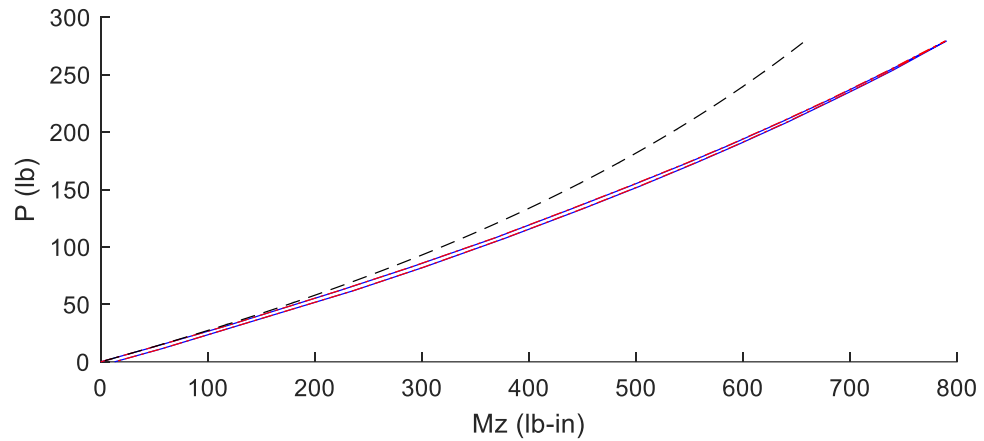
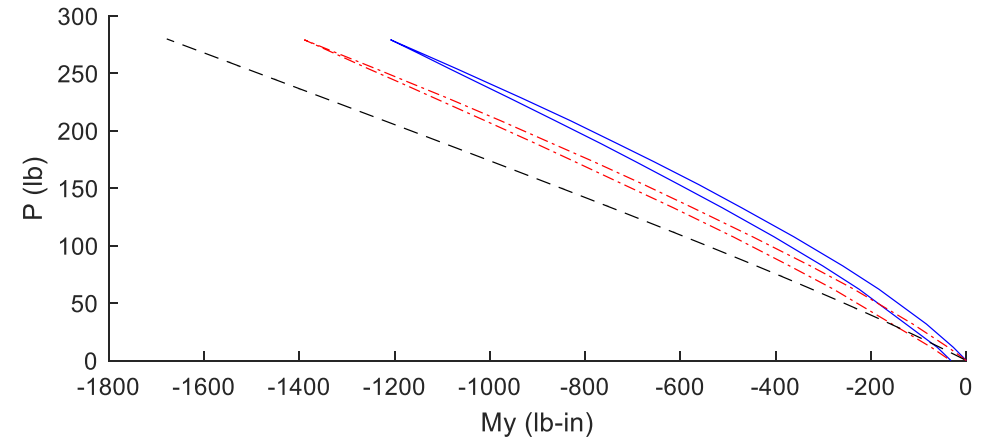
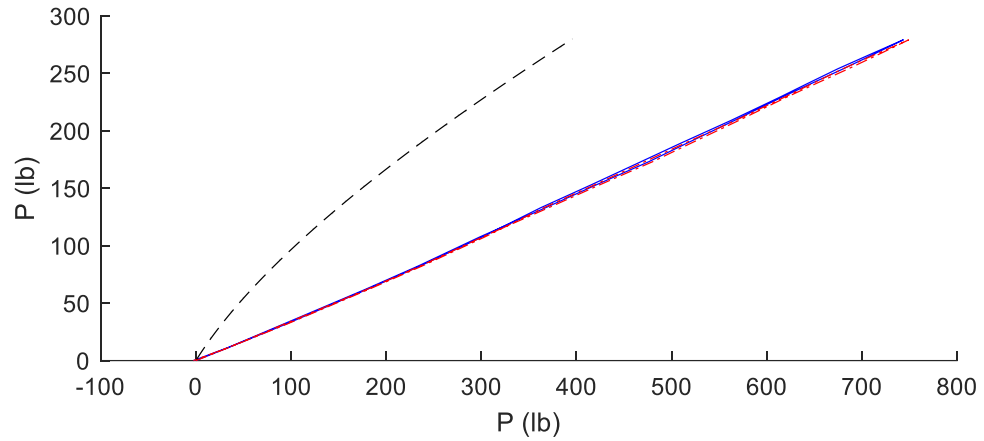

Force Comparisons

Position 5 Calculated Internal Forces

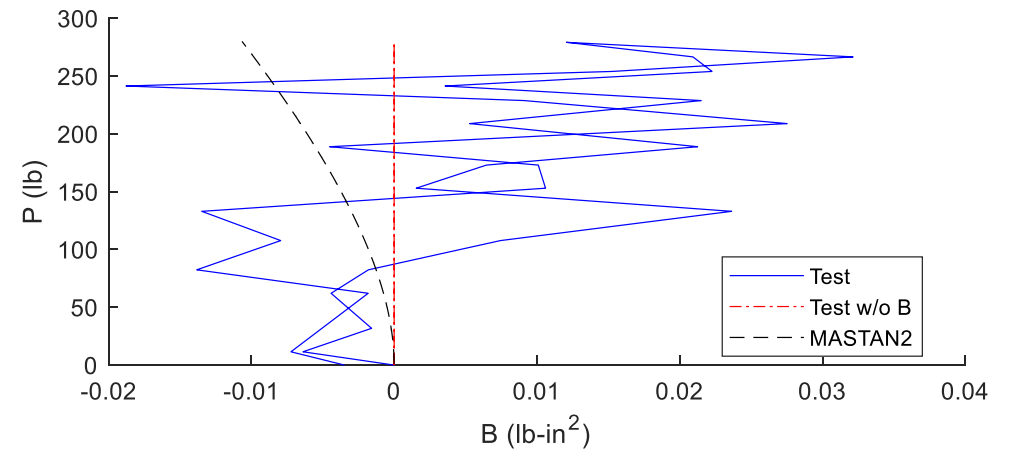
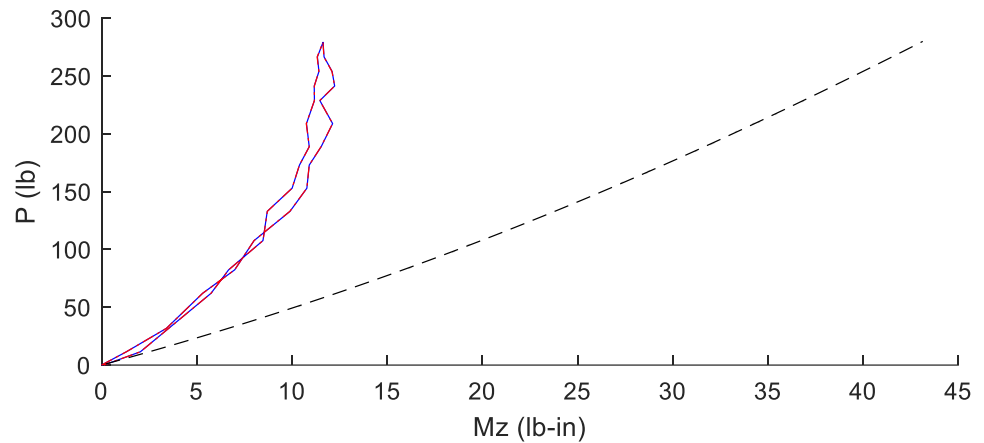
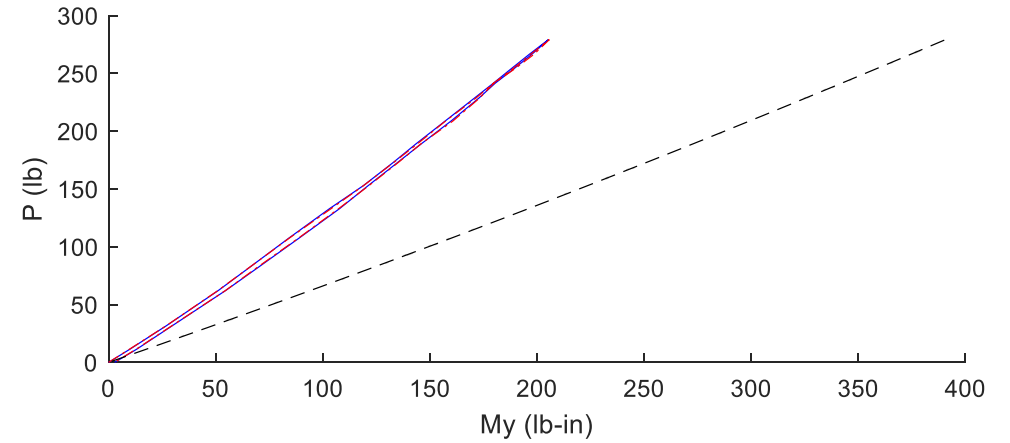
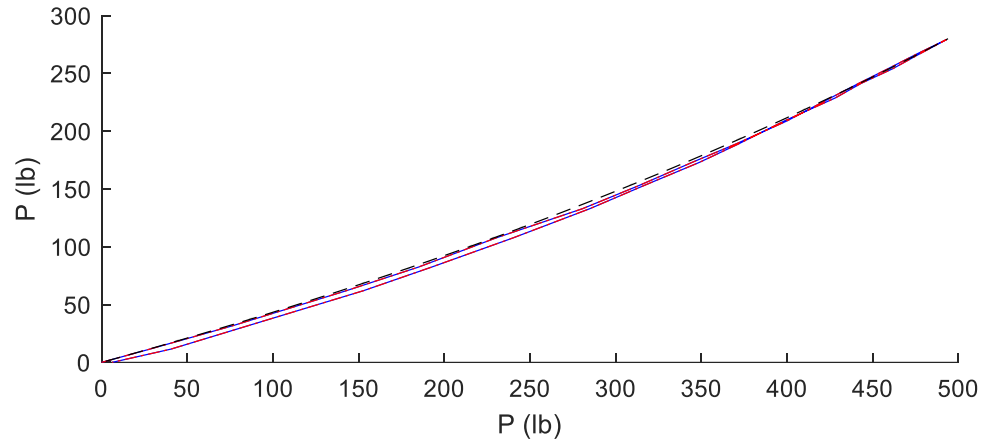

Stress Comparisons

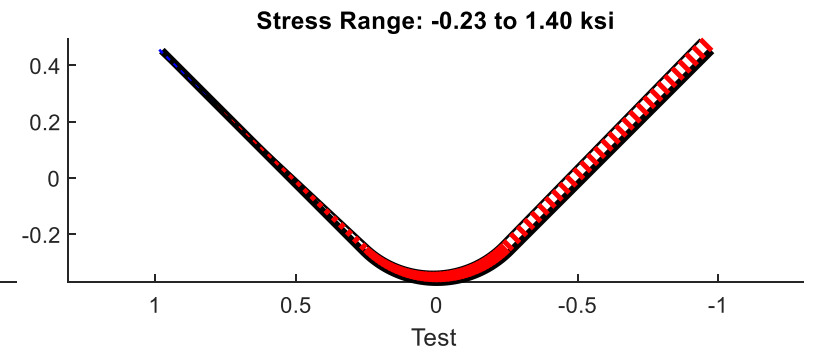
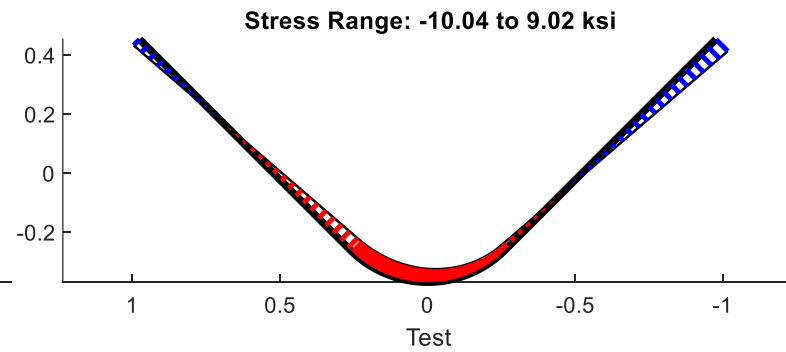
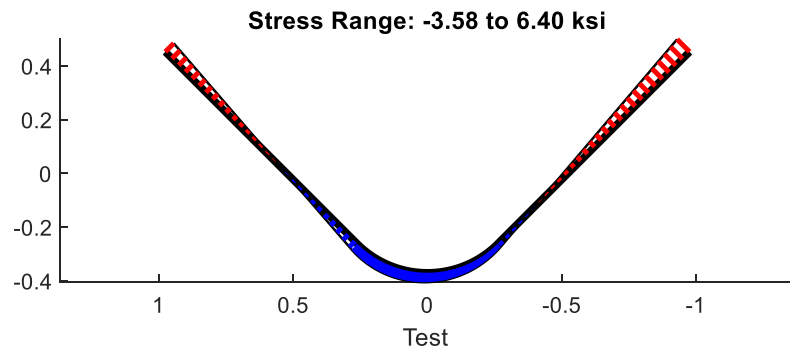
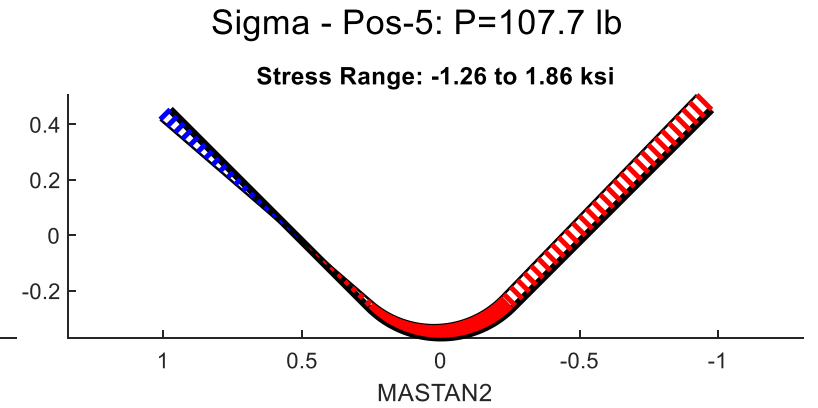
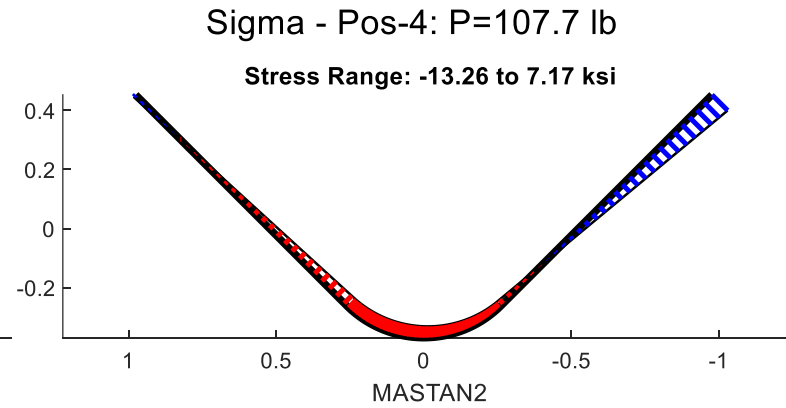
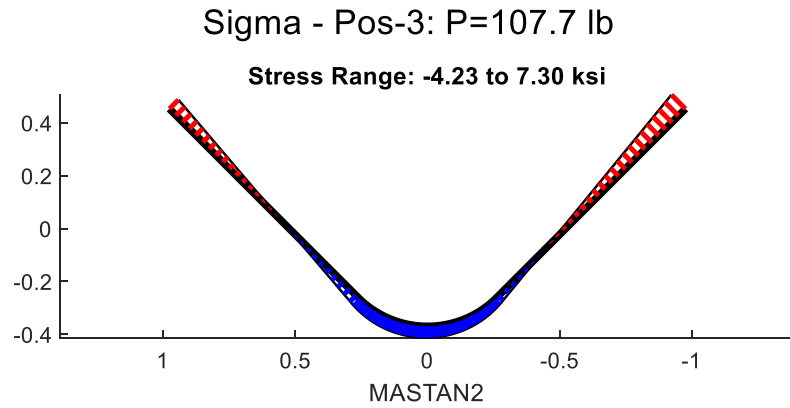

Stress Comparisons

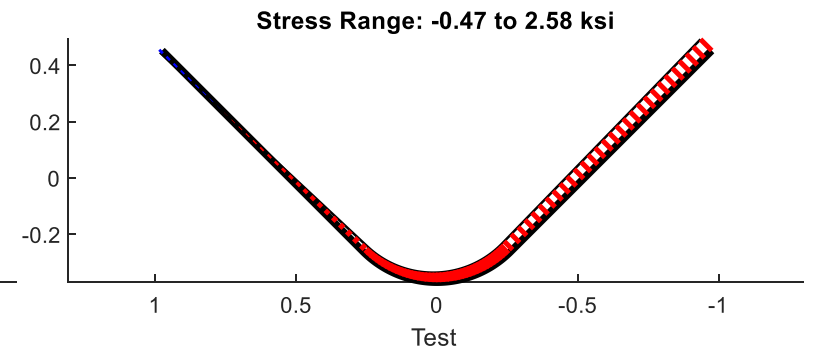
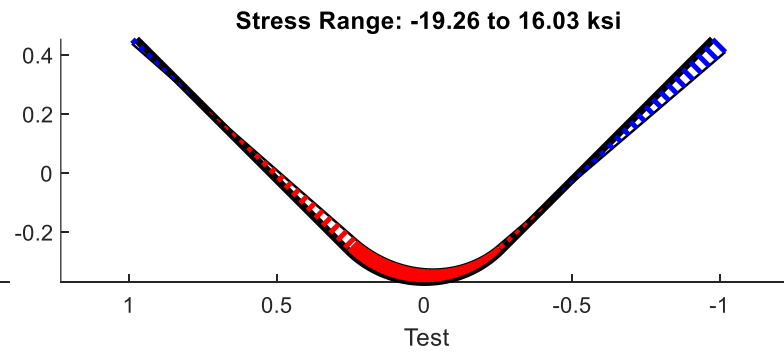
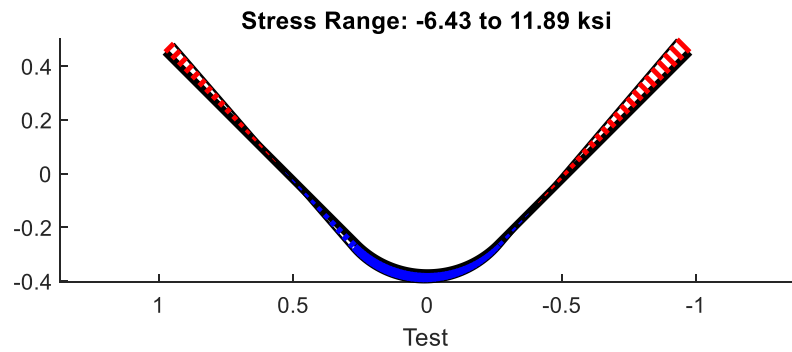
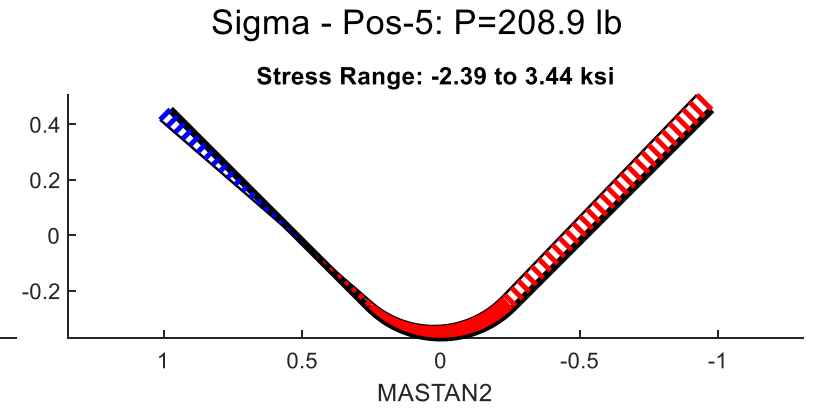
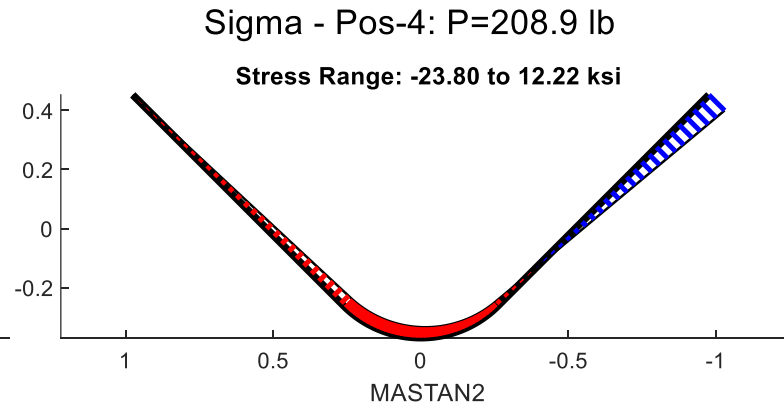
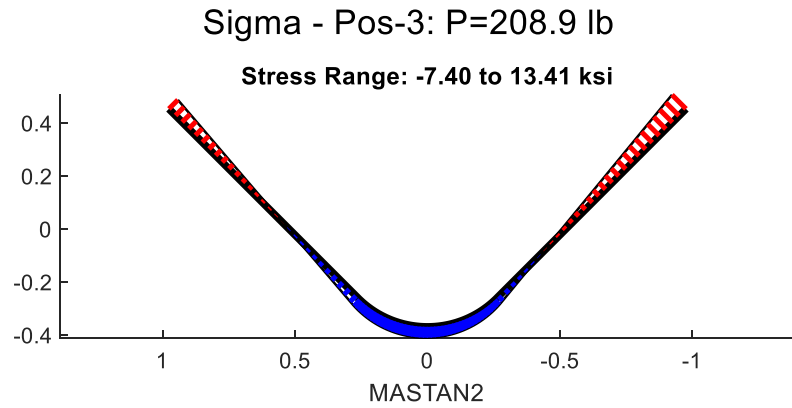

Stress Comparisons

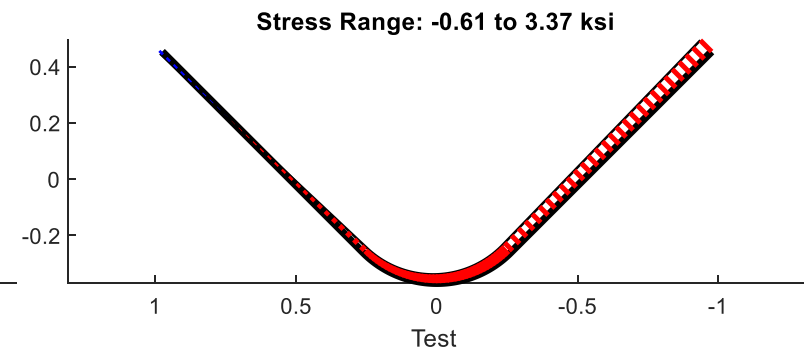
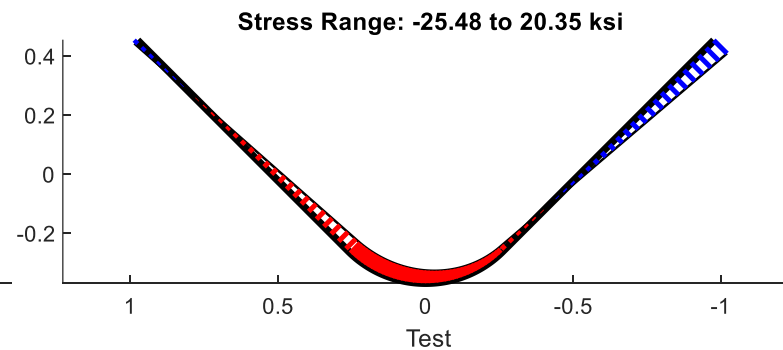
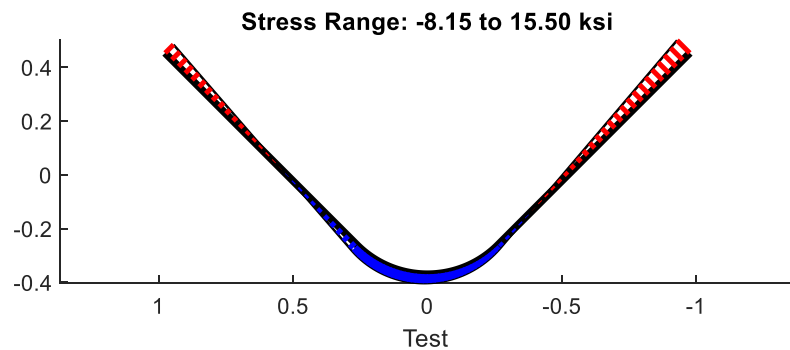
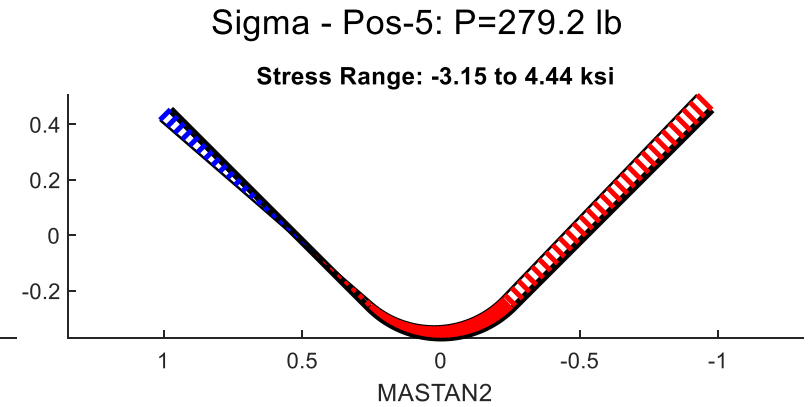
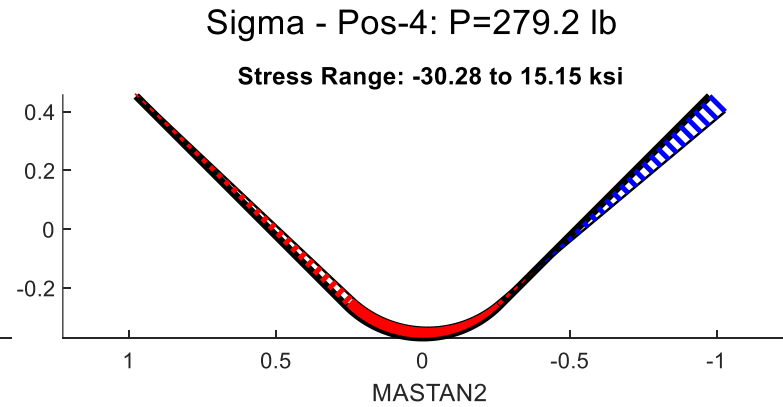
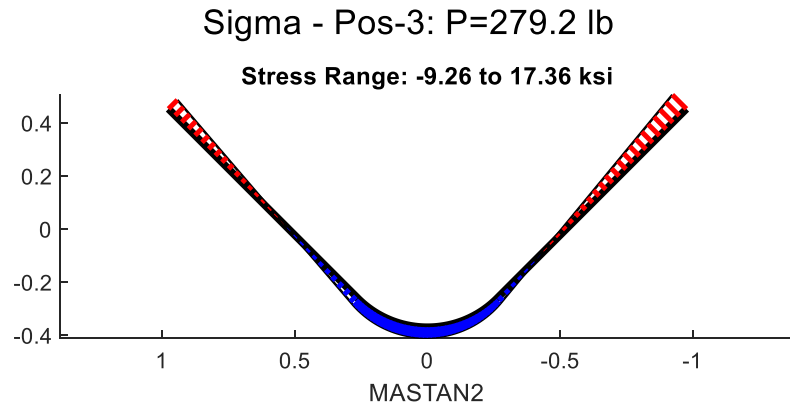

Extra Information

- While attempting to verify the results with the webs, it was noted that all the cross sections were not perfectly formed.
- One attempt to obtain better results required accounting for this altered geometry.
- The geometry was measured using the Artec Leo Scanner.
- A 3-D point cloud of the surface was created.



Extra Information

- The 3-D point cloud mesh could be segmented into separate chunks of information that could be used to create a profile.

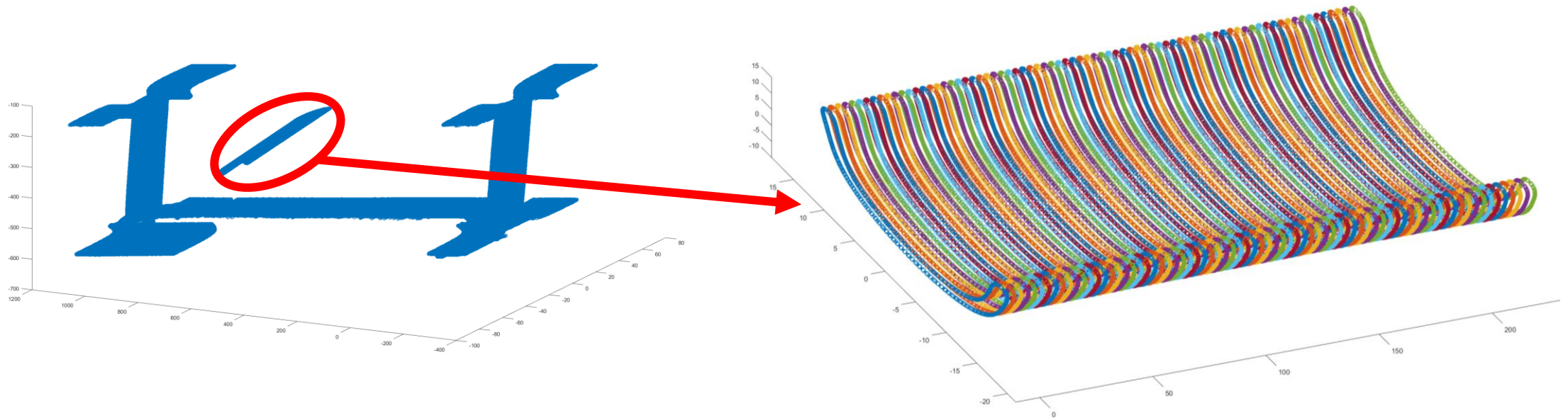

Extra Information

- Each profile is of the exterior and a calculation of the interior centerline was created.

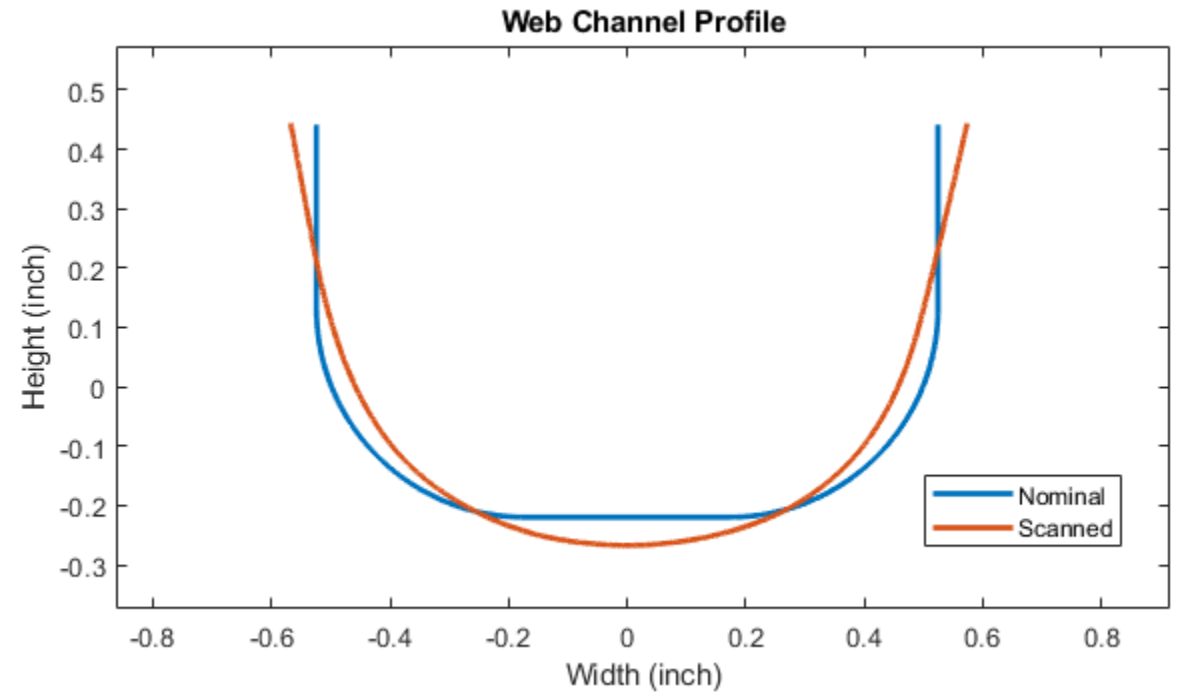
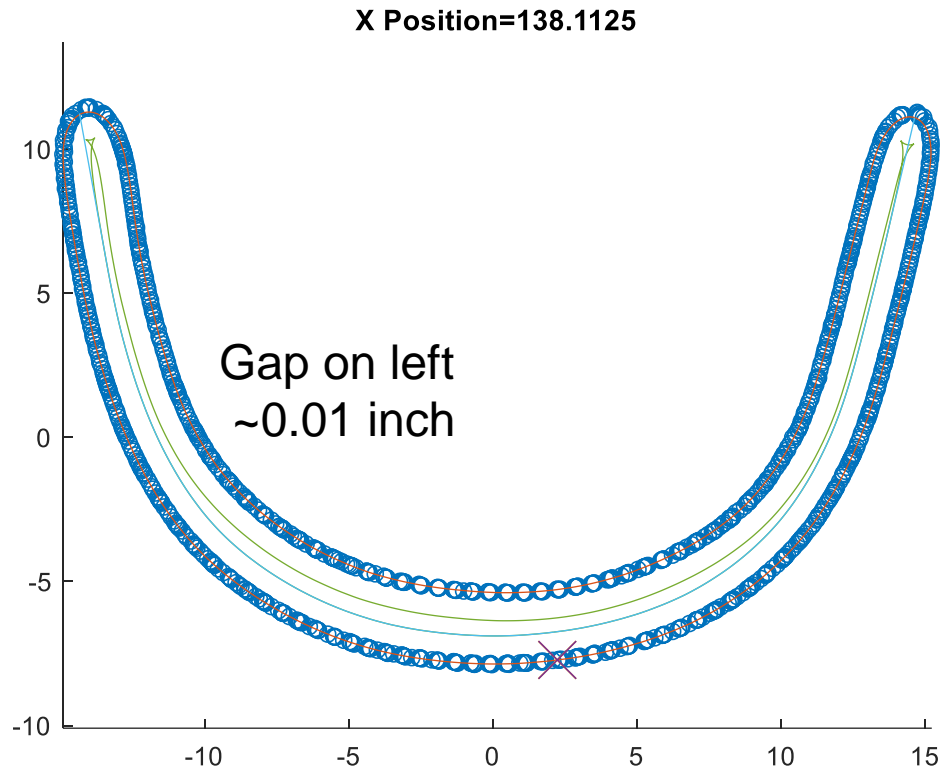

Extra Information

- The variation in the profile was found to have impact on the section properties; however, as mentioned earlier, it is not the controlling issue that was observed.

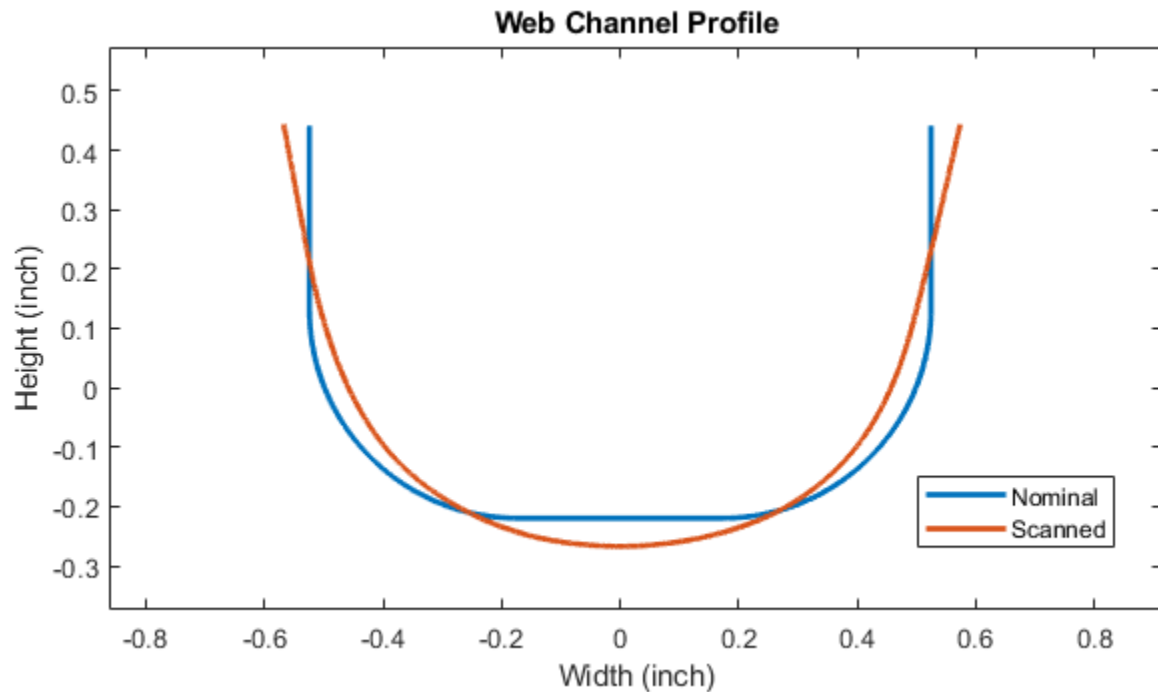

	Generic Section	Measured Section	Error Measured to Generic
A	0.1587	0.1567	-1.26%
J	3.11E-04	3.07E-04	-1.27%
I_{zz}	7.27E-03	7.90E-03	8.73%
I_{yy}	2.76E-02	2.65E-02	-4.19%
I_{yz}	0	0	-
y_s	-4.72E-01	-4.90E-01	3.82%
z_s	0	2.44E-04	-
C_w	7.62E-04	3.94E-04	-48.27%



Summary

Summary

- MASTAN2 was able to determine reasonable stress distributions matching the experiment of a joist subjected to an eccentric hanging load.
- In the calculated results from Scenario 1, there was a consistent underprediction of stresses in the initial condition prior to the application of the hanging load. But looking at the net change in Scenario 1 or the total loading in Scenario 2, MASTAN2 was consistently finding conservative values for stresses while matching the desired distribution of stress for the effect of the torsion applied to the chord.
- The largest variation was observed on the leg of the angle where the hanging load was applied 2” away from the strain gauge measurements.



Tutorial for MASTAN2 v5.1 - Introductory Frame

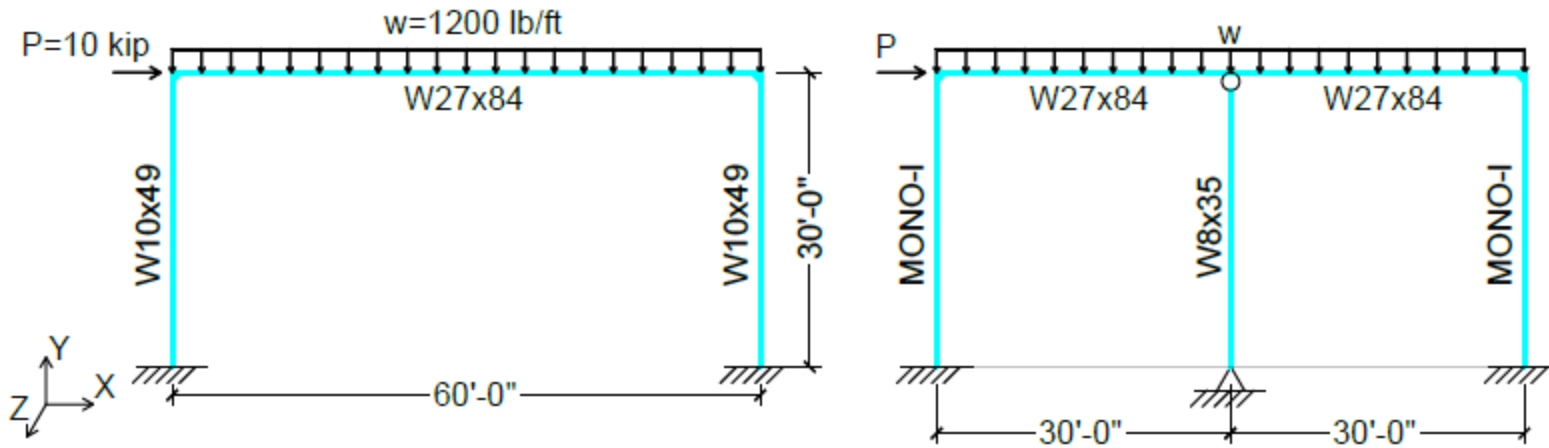

Credits

Published 2021

Developed by:

Edward J. Sippel, Ph.D. Student, University of Wisconsin – Madison

Hannah B. Blum, Assistant Professor, University of Wisconsin - Madison

Ronald D. Ziemian, Professor, Bucknell University

Joe Pote, Director of Research & Development, New Millennium Building Systems

Scott Morton, Research and Development Engineer, New Millennium Building Systems

Sponsored by:

American Iron and Steel Institute

New Millennium Building Systems

Steel Joist Institute

Steel Deck Institute



Tutorial Sections

Section 1: Overview

Section 2: Getting Started

Section 3: 2-D Frame Analysis

Section 4: 3-D Frame Analysis

Section 5: Using MSASect

Section 6: Frame Analysis with Non-Doubly Symmetric Sections

Navigation

 - Skip to Previous Section Title Page

 - Previous Slide

 - Return to Tutorial Sections Page

 - Next Slide

 - Skip to Next Section Title Page

 - Open screenshot of MASTAN2 or additional helpful information.

Section 1: Overview

Overview

This tutorial provides step-by-step guidance for the sample frame structure. Enough details are provided that the example model with non-doubly symmetric sections can be completed following the instructions here. Not every feature available in MASTAN2 will be mentioned nor utilized in this tutorial. For further information on several additional features within MASTAN2, it is recommended the user make use of other tutorials at <http://www.mastan2.com/tutorial.html>.



Problem Overview

This tutorial will start with the simple one-bay frame shown on the left. This model will then be altered to the two-bay frame shown on the right include non-doubly symmetric sections. Further details of each model will be provided in the corresponding section.

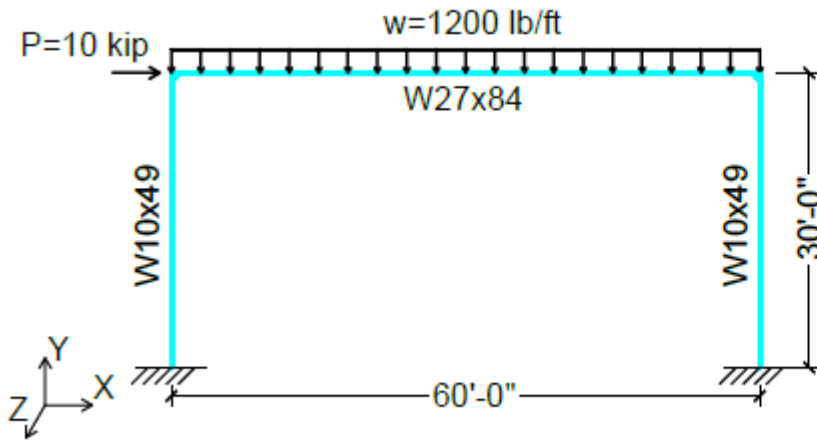

Starting Frame

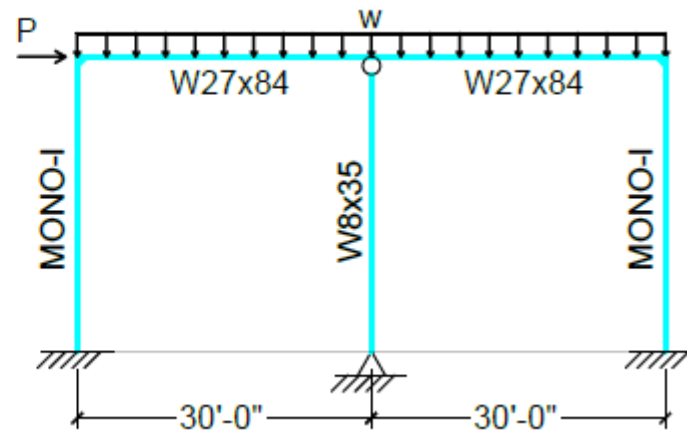

Final Frame



Section 2: Getting Started

MASTAN2 General Information

MASTAN2 is an interactive graphics program that provides preprocessing, analysis, and postprocessing capabilities. Preprocessing options include definition of structural geometry, support conditions, applied loads, and element properties. The analysis routines provide the user the opportunity to perform first- or second-order elastic or inelastic analyses of two- or three-dimensional frames and trusses subjected to static and dynamic loads. Postprocessing capabilities include the interpretation of structural behavior through deformation and force diagrams, printed output, and facilities for plotting response curves. MASTAN2 is based on MATLAB®, a premier software package for numeric computing and data analysis.

In many ways, MASTAN2 is similar to today's commercially available software in functionality. The number of pre- and post-processing options, however, have been limited in order to minimize the amount of time needed for a user to become proficient at its use. The program's linear and nonlinear analysis routines are based on the theoretical and numerical formulations presented in the text *Matrix Structural Analysis, 2nd Edition*, by McGuire, Gallagher, and Ziemian. In this regard, the reader is strongly encouraged to use this software as a tool for demonstration, reviewing examples, solving problems, and perhaps performing analysis and design studies. Where MASTAN2 has been written in modular format, the reader is also provided the opportunity to develop and implement additional or alternative analysis routines directly within the program.

MATLAB is a registered trademark of The MathWorks, Inc., 3 Apple Hill Drive, Natick, MA 01760-2098.



Launching MASTAN2

Two versions of MASTAN2 have been developed and may be installed. One requires you to have access to MATLAB and the other does not. Both versions provide the same functionality, except that the MATLAB version also provides the user an opportunity to develop and implement additional or alternative analysis routines that will directly interact with MASTAN2. Please see the Setup Guides at www.mastan2.com.

MASTAN2 v3.5

Home
About
FAQ's
Screenshots
Tutorial
Stability Fun
Textbook
Download
Contact

Designed By
Projectdesigns.org
XHTML 1.0 Strict

Overview
MASTAN2 is an interactive structural analysis program that provides preprocessing, analysis, and postprocessing capabilities.

- Preprocessing
- Analysis
- Postprocessing

Preprocessing
Preprocessing options include definition of structural geometry, support conditions, applied loads, and element properties.

Analysis
The analysis routines provide the user the opportunity to perform first- or second-order elastic or inelastic analyses of two- or three-dimensional frames and trusses subjected to static loads.

Postprocessing
Postprocessing capabilities include the interpretation of structural behavior through deformation and force diagrams, printed output, and facilities for plotting response curves.

Start Here



Base Layout

In order to minimize the learning time for MASTAN2, its graphical user interface (GUI) has been designed using a simple and consistent two menu approach. Using a pull-down menu at the top of the GUI, a command is selected. Parameters are then defined in the bottom menu bar and the command is executed by using the Apply button.

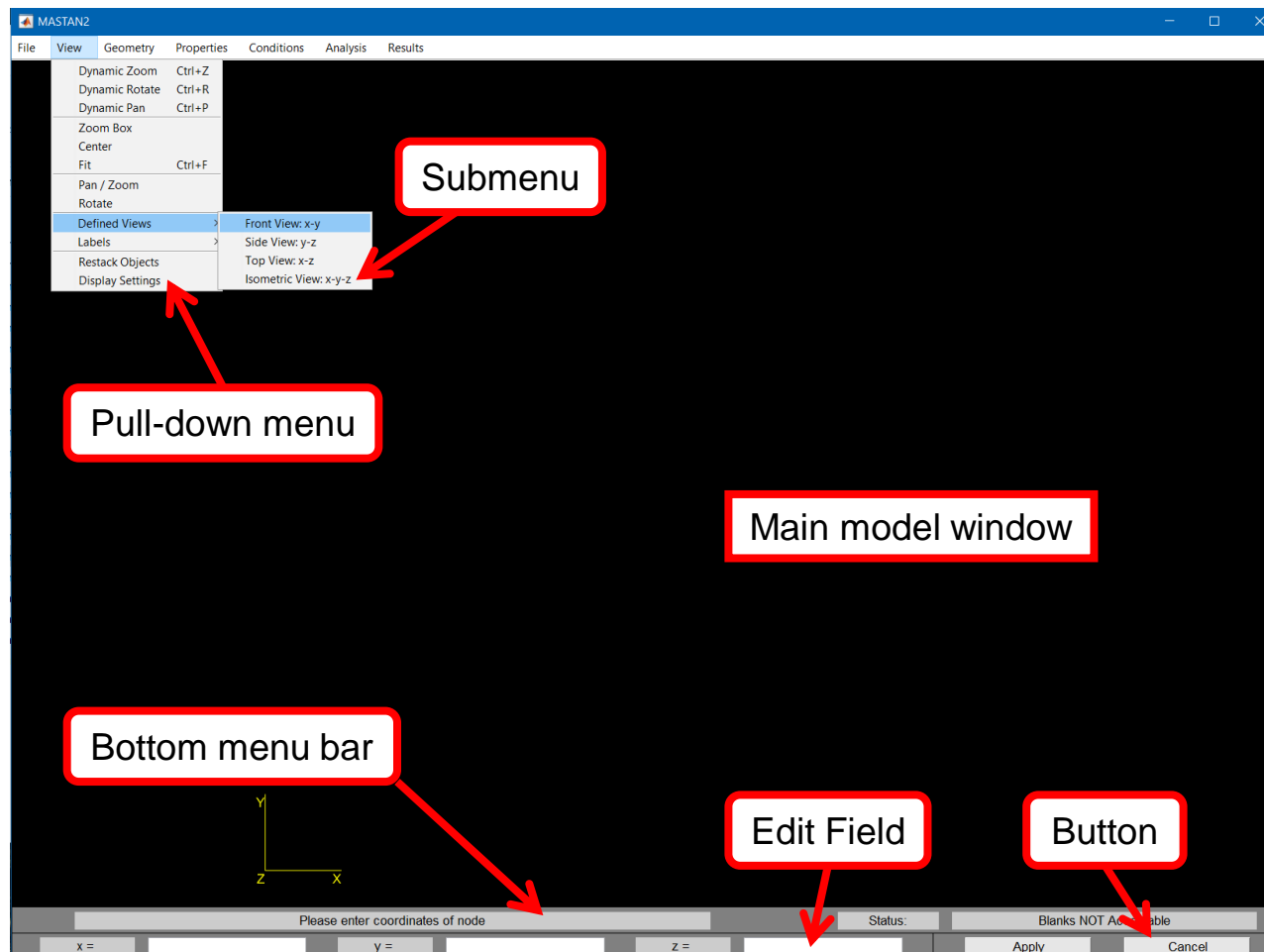

Section 3: 2-D Frame Analysis

Problem Description - Figure

The frame is constructed of A992 steel with the properties indicated. The frame is also supported out of plane in the Z direction at the ends and middle of the beam. The connections are assumed to be fixed for warping.

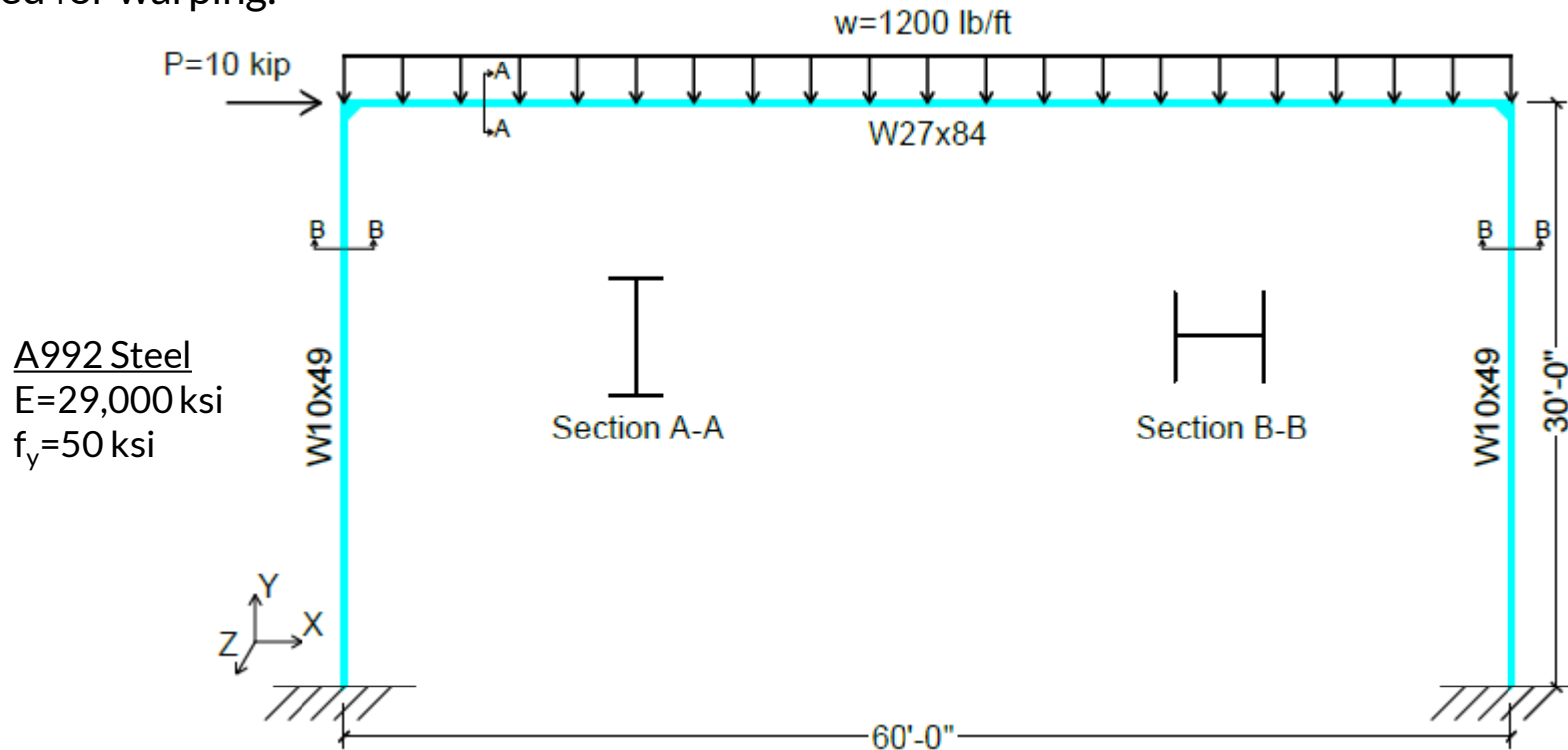





MASTAN2 does not assume any unit system. Models in MASTAN2 require the use of any consistent set of units. This tutorial will use kip and inch.

A few steps completed as part of this segment of the tutorial are not specifically required for a 2-D analysis. Comments are provided to identify them.



Geometry Definition

- 1) Start with a new, empty model. 
- 2) From the **Geometry** menu select **Define Frame**.
- 3) At the bottom menu bar, click the pop-up menu to the left of **bays @** and change **0** to **1**. Click in the edit box to the right of **bays @** and change **0** to **720**.
- 4) Click the pop-up menu to the left of **stories @** and change **0** to **1**. Click in the edit box to the right of **stories @** and change **0** to **360**.
- 5) Click on the **Apply** Button. A one-bay single story frame is now defined. 

Clicking the  icon will advance the tutorial to a page that provides an image of the MASTAN2 interface after the corresponding step is executed. Clicking the  icon on that page will return you to the step-by-step instructions.



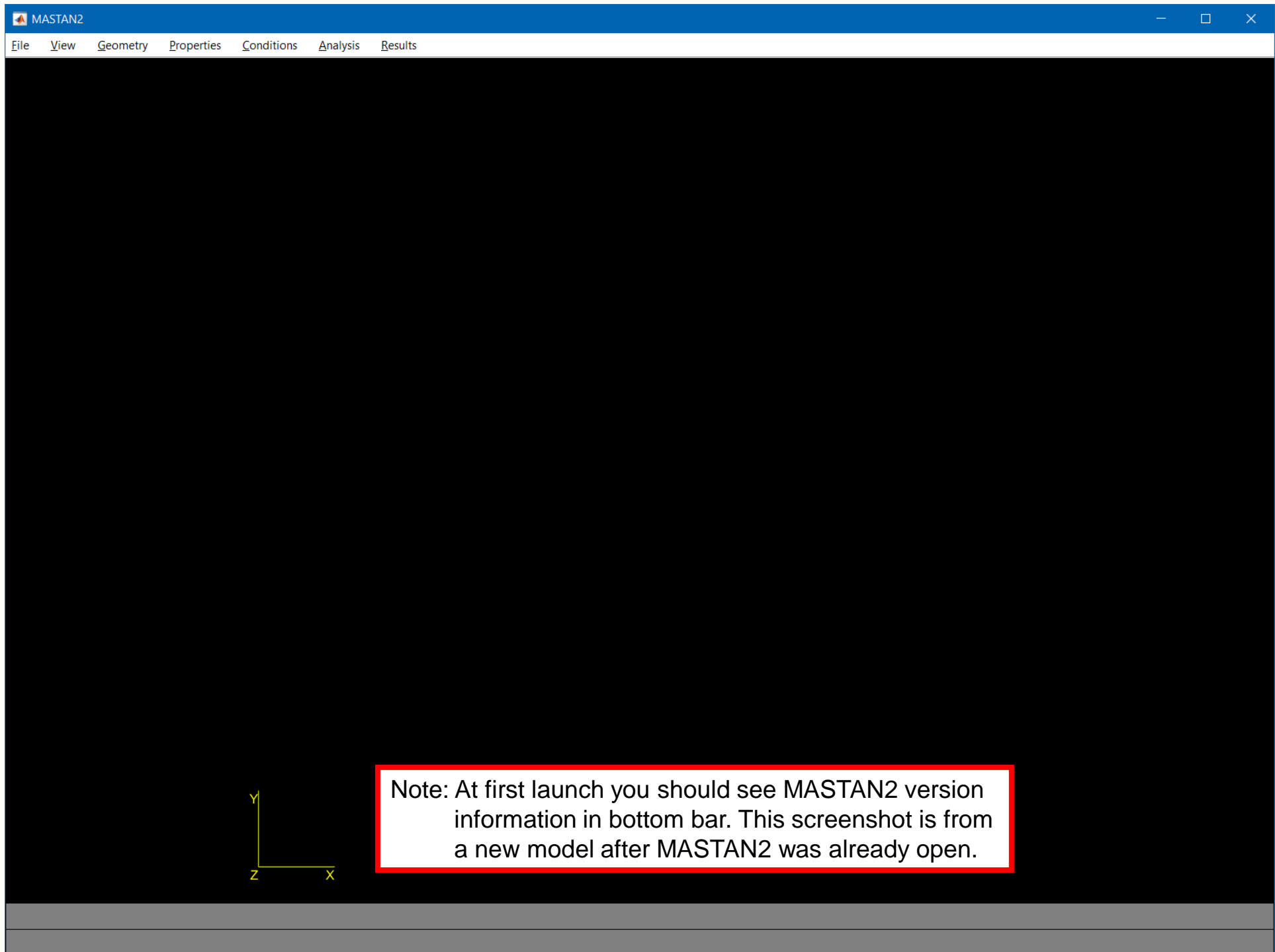

MASTAN2

File View Geometry Properties Conditions Analysis Results

The image shows the MASTAN2 software interface. The main window displays a rectangular frame structure defined by four nodes: N1 (bottom-left), N2 (bottom-right), N3 (top-left), and N4 (top-right). The frame consists of three elements: E1 (left vertical member), E2 (top horizontal member), and E3 (right vertical member). A coordinate system is shown at the bottom left with the Z-axis pointing up, the X-axis pointing right, and the Y-axis pointing out of the page. The status bar at the bottom indicates "Success: Frame Generated." and contains input fields for structure dimensions: 1 bays @ 720, 1 stories @ 360, and 1 frames @ 0.



Please enter repetitions and dimensions of structure

Status: Success: Frame Generated.

1	bays @	720	1	stories @	360	1	frames @	0	Apply	Cancel
---	--------	-----	---	-----------	-----	---	----------	---	-------	--------



Element Modification

- 1) From the **Geometry** menu select **Subdivide Element(s)**.
- 2) Create the list of elements by clicking on the horizontal element.
- 3) Since the number of segments is already set at **2**, click on the **Apply** button. 
- 4) Create a new list of all elements by clicking the **All** button.
- 5) Click the **>** button to the right of **# of Segments =** to increase **2** to **8**.
- 6) Click on the **Apply** button. 

MASTAN2

File View Geometry Properties Conditions Analysis Results

The image shows the MASTAN2 software interface. The main window displays a rectangular mesh structure on a black background. The mesh consists of four vertical elements (E1, E2, E3, E4) and two horizontal elements (E3, E4). The nodes are labeled N1, N2, N3, N4, and N5. A coordinate system is shown at the bottom left with axes X, Y, and Z. The status bar at the bottom indicates "Success: Element(s) subdivided." and the number of segments is 2.

Please select element(s) and number of segments

Status: Success: Element(s) subdivided.

Element(s): All Clr Adv # of Segments = < 2 > Apply Cancel



MASTAN2

File View Geometry Properties Conditions Analysis Results

The image displays the MASTAN2 software interface. The main window shows a structural model with nodes (N1 to N19) and elements (E1 to E32). A coordinate system (X, Y, Z) is shown at the bottom left. The status bar at the bottom indicates "Success: Element(s) subdivided." and shows "# of Segments = 8".

Please select element(s) and number of segments

Status: Success: Element(s) subdivided.

Element(s): All Clr Adv # of Segments = < 8 > Apply Cancel



Model Cleanup

These steps are not technically required; however, it will help makes it easier to find results in the model. Additionally, any reference to node or element number will be using this updated reference.

- 1) From the **Geometry** menu select **Renumber Elements**.
- 2) Click the checkbox to the left of **Y-X-Z (2D)**. Click on the **Apply** button.
- 3) From the **Geometry** menu select **Renumber Nodes**.
- 4) Click the checkbox to the left of **Y-X-Z (2D)**. Click on the **Apply** button. 

MASTAN2

File View Geometry Properties Conditions Analysis Results

The diagram shows a rectangular frame structure with nodes labeled N1 through N33 and elements labeled E1 through E32. The nodes are arranged in a grid: N1-N25 form the perimeter, and N9-N24 form the top horizontal edge. Elements connect adjacent nodes. A coordinate system is shown at the bottom left with X, Y, and Z axes.

Please define direction sequence for renumbering nodes



Status: Complete: Bandwidth Decreased.

X-Y-Z (2D) X-Z-Y Y-X-Z (2D) Y-Z-X Z-X-Y Z-Y-X Random

Apply Cancel



Section Properties - Creating

- 1) From the **Properties** menu select **Define Section**.
- 2) At the bottom menu bar, click on the **Database** button.
- 3) In the pop-up menu, scroll to find Section: **W10x49** and click on it. 
- 4) Then click on the **Apply** button. Section 1 is now defined with the properties of W10x49. 
- 5) Repeat step 3 with Section: **W27x84**. After clicking the **Apply** button, Section 2 will be defined.

For the initial 2-D analysis, only **Area**, **I z-z**, and **Z z-z** would be required. The other section properties are only needed when moving to 3-D analysis.



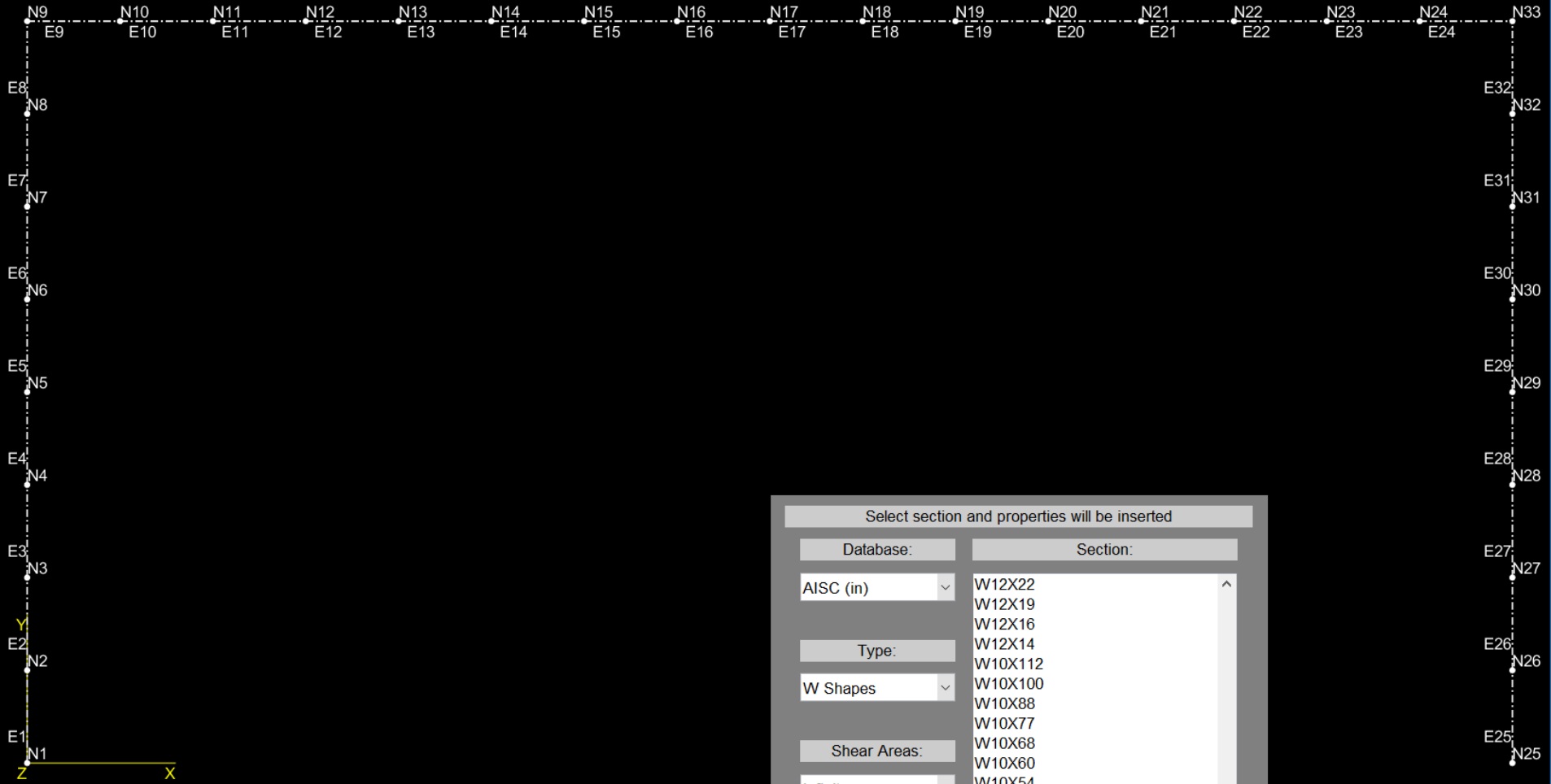

Select section and properties will be inserted

Database:	Section:
AISC (in)	W12X22
	W12X19
	W12X16
	W12X14
	W10X112
Type:	W10X100
W Shapes	W10X88
	W10X77
Shear Areas:	W10X68
	W10X60
infinite	W10X54
	W10X49
	W10X45
	W10X39
	W10X32

Please enter section properties		Section 1	Name:	W10X49	<input checked="" type="radio"/> Database	Status:				
Area =	14.4	I z-z =	272	I y-y =	93.4	J =	1.39	Cw =	2070	Basic
Z z-z =	60.4	Z y-y =	28.3	A y-y =	Inf	A z-z =	Inf	Apply	Cancel	



MASTAN2

File View Geometry Properties Conditions Analysis Results



Select section and properties will be inserted

Database:	Section:
AISC (in)	W12X22
	W12X19
	W12X16
	W12X14
	W10X112
Type:	W10X100
W Shapes	W10X88
	W10X77
Shear Areas:	W10X68
	W10X60
infinite	W10X54
	W10X49
	W10X45
	W10X39
	W10X32

Please enter section properties		Section 2	Name:		<input checked="" type="radio"/> Database	Status:	Success: Section 1 defined.			
Area =	0	I z-z =	0	I y-y =	0	J =	0	Cw =	0	Basic
Z z-z =	inf	Z y-y =	inf	A y-y =	inf	A z-z =	inf	Apply	Cancel	



Section Properties - Assigning

- 1) From the **Properties** menu select **Attach Section**.
- 2) At the bottom menu bar, use the buttons to the right of **Element(s)**: to make the list of elements.
- 3) Click the **Adv** button to open pop-up menu. To select all the vertical elements, click the check box next to the **Y-axis** option. Click **Add** to add all vertical elements to the element list.
- 4) Click on the **Apply** button to assign Section 1. (Note that the element line style has changed from dash-dot to dashed.) 
- 5) Select the **Clr** button located to the right of **Elements**: to clear the list of elements.
- 6) Create a list of the remaining elements by clicking the **All** button and then the **Remove** button in the pop-up menu. This should leave only the horizontal members selected.
- 7) Change the **Section #** by clicking on the current section number, **1**, just to the right to open a pop-up menu with all section numbers. Click on **2** to select the W27x84 section.
- 8) Assign Section #2 properties by clicking the **Apply** button. 



MASTAN2

File View Geometry Properties Conditions Analysis Results

Advanced Element Selection

Parallel to: On

X-axis

Y-axis

Z-axis

Range (Inclusive): Off

-Inf	X	Inf
-Inf	Y	Inf
-Inf	Z	Inf

Add Remove Reset

Select Section # and element(s) Element(s): 1 2 3 4 5 6 7 8 25 26 27 All Clr Adv Status: Success: Section attached.

Section # 1 Details: W10X49 <Click to see properties> Apply Cancel



MASTAN2

File View Geometry Properties Conditions Analysis Results

Advanced Element Selection

Parallel to: On

X-axis

Y-axis

Z-axis

Range (Inclusive) Off

-Inf	X	Inf
-Inf	Y	Inf
-Inf	Z	Inf

Add Remove Reset

Select Section # and element(s) Element(s): 9 10 11 12 13 14 15 16 17 18 All Clr Adv Status: Success: Section attached.

Section # 2 Details: W27X84 <Click to see properties> Apply Cancel



Material Properties

- 1) From the **Properties** menu select **Define Material**.
- 2) At the bottom menu bar, click in the edit box just to the right of **E=** and change the **0** to **29000** (not 29,000). Similarly, click in the edit box just to the right of **Fy=** and change the **inf** to **50**. Next, click in the edit box to the right of **Name:** and type **A992**. Click on the **Apply** button. (Material #1 is now defined with the properties of A992 steel.)
- 3) From the **Properties** menu select **Attach Material**.
- 4) At the bottom menu bar, create the list of elements to be assigned the properties of Material 1 by clicking on the **All** button to the right of **Elements:**. Click on the **Apply** button. (Note that elements with assigned section and material properties turn solid.) 

MASTAN2

MASTAN2

File View Geometry Properties Conditions Analysis Results

Nodes: N1, N2, N3, N4, N5, N6, N7, N8, N9, N10, N11, N12, N13, N14, N15, N16, N17, N18, N19, N20, N21, N22, N23, N24, N25, N26, N27, N28, N29, N30, N31, N32, N33

Elements: E1, E2, E3, E4, E5, E6, E7, E8, E9, E10, E11, E12, E13, E14, E15, E16, E17, E18, E19, E20, E21, E22, E23, E24, E25, E26, E27, E28, E29, E30, E31, E32

Material # 1 Details: A992 <Click to see properties>

Status: Success: Material attached.

Apply Cancel



Support Conditions

- 1) From the **Conditions** menu select **Define Fixities**.
- 2) At the bottom menu bar, define a fixed support by clicking in the **check boxes** just to the left of all six degrees of freedom: **X-disp**, **Y-disp**, **Z-disp**, **X-rot**, **Y-rot**, and **Z-rot**.
- 3) Create the list of nodes to be assigned these fixities by clicking on the bottom two nodes of the model, **1** and **25**.
- 4) Click on the **Apply** button.
- 5) From the **View** menu select **Fit**. 

For the initial 2-D analysis, only **X-disp**, **Y-disp**, and **Z-rot** would need to be constrained for full fixity. The other fixities are only needed when moving to 3-D analysis.



MASTAN2



File View Geometry Properties Conditions Analysis Results

The image displays the MASTAN2 software interface. The main window shows a frame structure with nodes labeled N1 through N33 and elements labeled E1 through E33. The structure consists of a horizontal beam at the top, two vertical columns on the left and right, and a horizontal beam at the bottom. Nodes are numbered sequentially along each member. A coordinate system is shown at the bottom left with X, Y, and Z axes. At the bottom, a dialog box is open with the following content:

Please select node(s) and fixity(s)		Node(s):	1 25	All	Clr	Adv	Status:	Success: Node fixities defined.	
<input checked="" type="checkbox"/> X-disp	<input checked="" type="checkbox"/> Y-disp	<input checked="" type="checkbox"/> Z-disp	<input checked="" type="checkbox"/> X-rot	<input checked="" type="checkbox"/> Y-rot	<input checked="" type="checkbox"/> Z-rot	Apply		Cancel	



Loading

- 1) From the **Conditions** menu select **Define Forces**.
- 2) At the bottom menu bar, click in the edit box just to the right of **PX =** and change the **0** to **10**.
- 3) Create the list of nodes to be assigned these forces by clicking on the upper left-hand node, **9**.
- 4) Click on the **Apply** button. 
- 5) From the **Conditions** menu select **Define Uniform Loads**.
- 6) Since the loading input is already **Element(s) local x'-y'-z'**, click in the edit box just to the right of **wy' =** and change **0** to **-0.1**.
- 7) Click the **Adv** button to open pop-up menu. Create a list of the horizontal elements by clicking the **All** button and then the **Remove** button in the pop-up menu.
- 8) Click on the **Apply** button.
- 9) From the **View** menu select **Fit**. 

MASTAN2

File View Geometry Properties Conditions Analysis Results

The image displays the MASTAN2 software interface. The main window shows a structural model with nodes labeled N1 through N33 and elements labeled E1 through E33. A force is applied at node N9, indicated by a green arrow pointing to the right. The status bar at the bottom indicates that the forces at the nodes have been successfully defined. The input fields show the force components: PX = 10, PY = 0, and PZ = 0.

Please define node(s) and forces	Node(s):	9	All	Clr	Adv	Status:	Success: Forces at nodes defined.
PX =	10	PY =	0	PZ =	0	Apply	Cancel



MASTAN2

File View Geometry Properties Conditions Analysis Results

Advanced Element Selection

Parallel to: X-axis Y-axis Z-axis

Range (Inclusive) X Y Z

Add Remove Reset

Status: Success: Element loads defined.

Please define element(s) and loads Element(s): 9 10 11 12 13 14 15 16 17 18 All Clr Adv

Input ref. Element(s) local x'-y'-z' wx' = 0 wy' = -0.1 wz' = 0 Apply Cancel



Naming and Saving

These steps are technically optional as you can complete analysis without saving or applying a title; however, this is a good time to complete this.

- 1) From the **File** menu select **Define title**. At the bottom menu bar, click in the edit box to the right of **Title:** and type in a brief description of this effort. This text might include the model title, your name, and/or the assignment number. Click on the **Apply** button.
- 2) From the **File** menu select **Save As ...**. After selecting your destination folder, type in the filename **Frame** and click **Save**. Note that the top of the window has now changed to include the file name and directory as well as the time the file was last saved. 



MASTAN2



MASTAN2: C:\Users\SSIRL\Desktop\Frame.mat [14:44]

File View Geometry Properties Conditions Analysis Results

The diagram illustrates a structural frame model. It consists of a horizontal beam at the top and two vertical columns. The beam has nodes labeled N9 through N24 and elements E9 through E24. The left column has nodes N2 through N8 and elements E2 through E8. The right column has nodes N25 through N32 and elements E25 through E32. A coordinate system is defined at node N1, with the X-axis pointing right and the Z-axis pointing down. The Y-axis is also indicated. The status bar at the bottom shows 'Please enter title and select apply', 'Status:', and 'Success: Title defined.' Below the status bar, there are input fields for 'Title:' (containing 'Frame') and buttons for 'Apply' and 'Cancel'.



2-D First-Order Elastic Analysis

- 1) From the **Analysis** menu select **Static** and submenu option **1st-Order Elastic**.
- 2) At the bottom menu bar, click on the pop-up menu just to the right of **Analysis Type:** and Select **Planar Frame (x-y)**.
- 3) Click on the **Apply** button to perform the analysis. 
- 4) From the **Results** menu select **Diagrams** and submenu option **Deflected Shape**.
- 5) At the bottom menu bar, click on the **Apply** button. 
- 6) From the **Results** menu select **Node Displacements**.
- 7) On the undeflected shape, click on the node of interest in the upper right corner, **33**, and its components are provided in the bottom menu bar. 

Results:

Disp X	Disp Y	Disp Z	Rot X	Rot Y	Rot Z
2.688	-0.03312	N/A	N/A	N/A	0.01235

This can be repeated for other nodes by clicking on them or click in the edit box to the right of **Node:**, enter the value, and click **Apply**.



MASTAN2

MASTAN2: C:\Users\SSIRL\Desktop\Fram.mat [14:44]

File View Geometry Properties Conditions Analysis Results

The image displays the MASTAN2 software interface for a structural analysis. The main window shows a frame model with nodes labeled N1 through N33 and elements labeled E1 through E32. A distributed load is applied to the top horizontal member, represented by green downward-pointing arrows. The status bar at the bottom indicates the analysis type is 'First-Order Elastic Static Analysis' and the status is 'Success: Analysis Complete'. The applied load ratio is 1.000. The analysis type is set to 'Planar Frame (x-y)'. The status bar also includes 'Apply' and 'Cancel' buttons.

First-Order Elastic Static Analysis Status: Applied Load Ratio = 1.000 ----> Success: Analysis Complete

Analysis Type: Planar Frame (x-y) Apply Cancel



Deflected Shape: 1st-Order Elastic, Incr # 1, Applied Load Ratio = 1

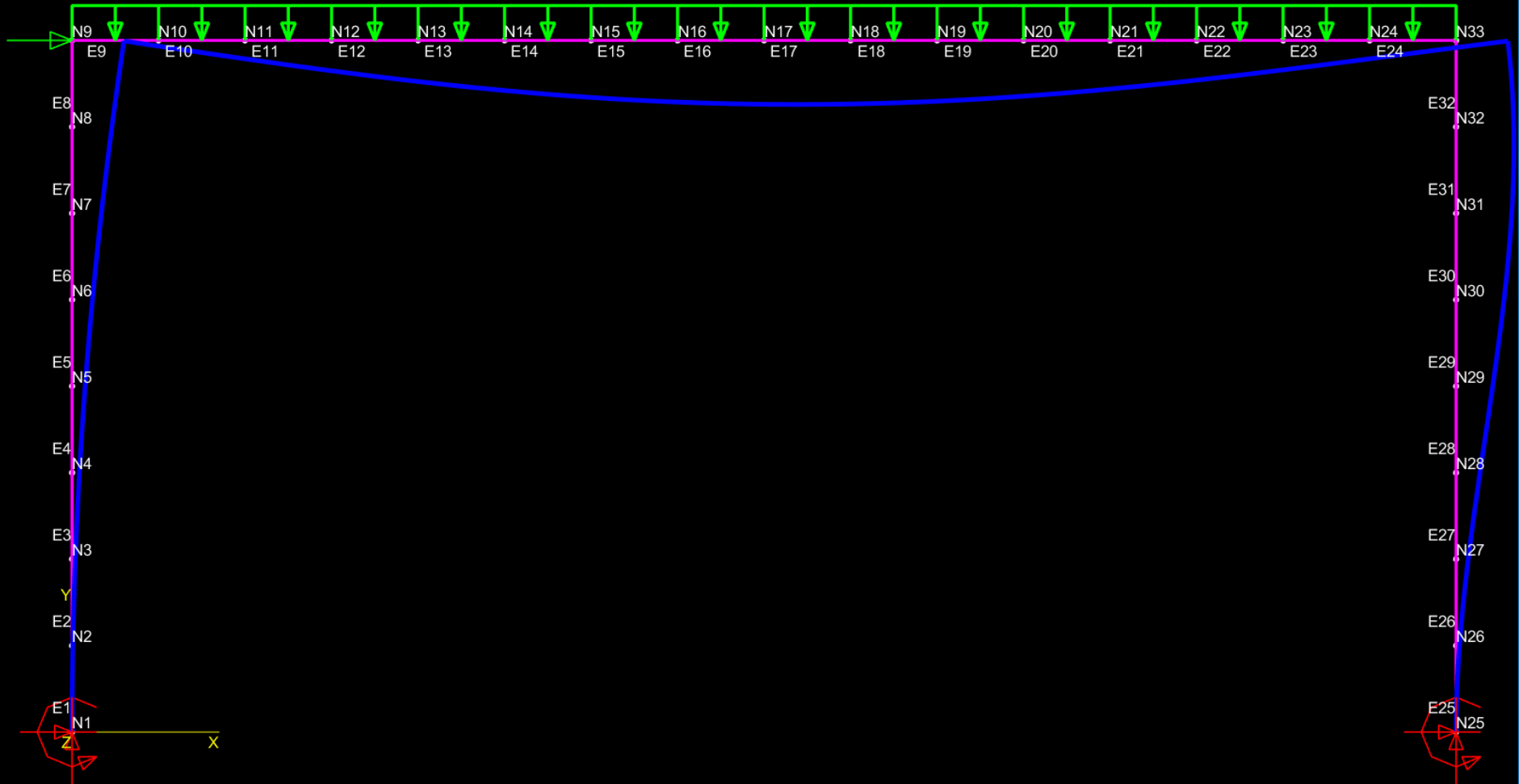

Define element(s) and parameters	Element(s):	All	All	Clr	Adv	Status:	Success: Deflection shown		
Defl Line Type	Solid	Scale	10	# of pts	10	<input type="checkbox"/> Animate	(1) 1.000	Apply	Cancel



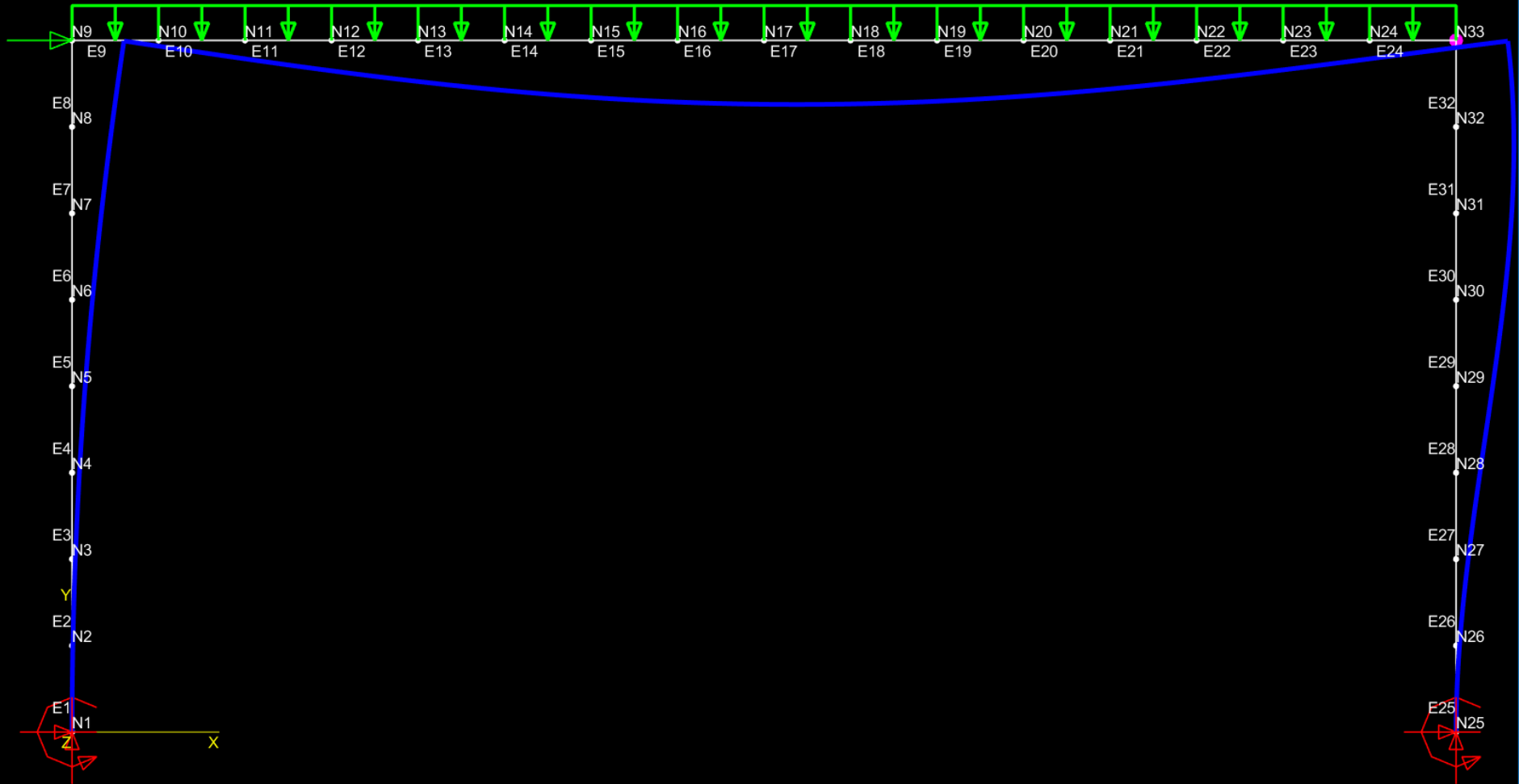

Deflected Shape: 1st-Order Elastic, Incr # 1, Applied Load Ratio = 1



Node:	33	Disp X:	2.688	Disp Y:	-0.03312	Disp Z:		Status:	Success: Disp. at ALR = 1.0000
Displacements	Rot X:		Rot Y:		Rot Z:	0.01235	(1) 1.000	Apply	Cancel



2-D Second-Order Elastic Analysis

- 1) From the **Analysis** menu select **Static** and submenu option **2nd-Order Elastic**.
- 2) At the bottom menu bar, click on the pop-up menu just to the right of **Analysis Type:** and Select **Planar Frame (x-y)**.
- 3) Click on the **Apply** button to perform the analysis. 
- 4) From the **Results** menu select **Node Displacements**.
- 5) On the undeflected shape, click on the node of interest in the upper right corner, **33**, and its components are provided in the bottom menu bar. 

Results:

Disp X	Disp Y	Disp Z	Rot X	Rot Y	Rot Z
2.852	-0.05354	N/A	N/A	N/A	0.01243



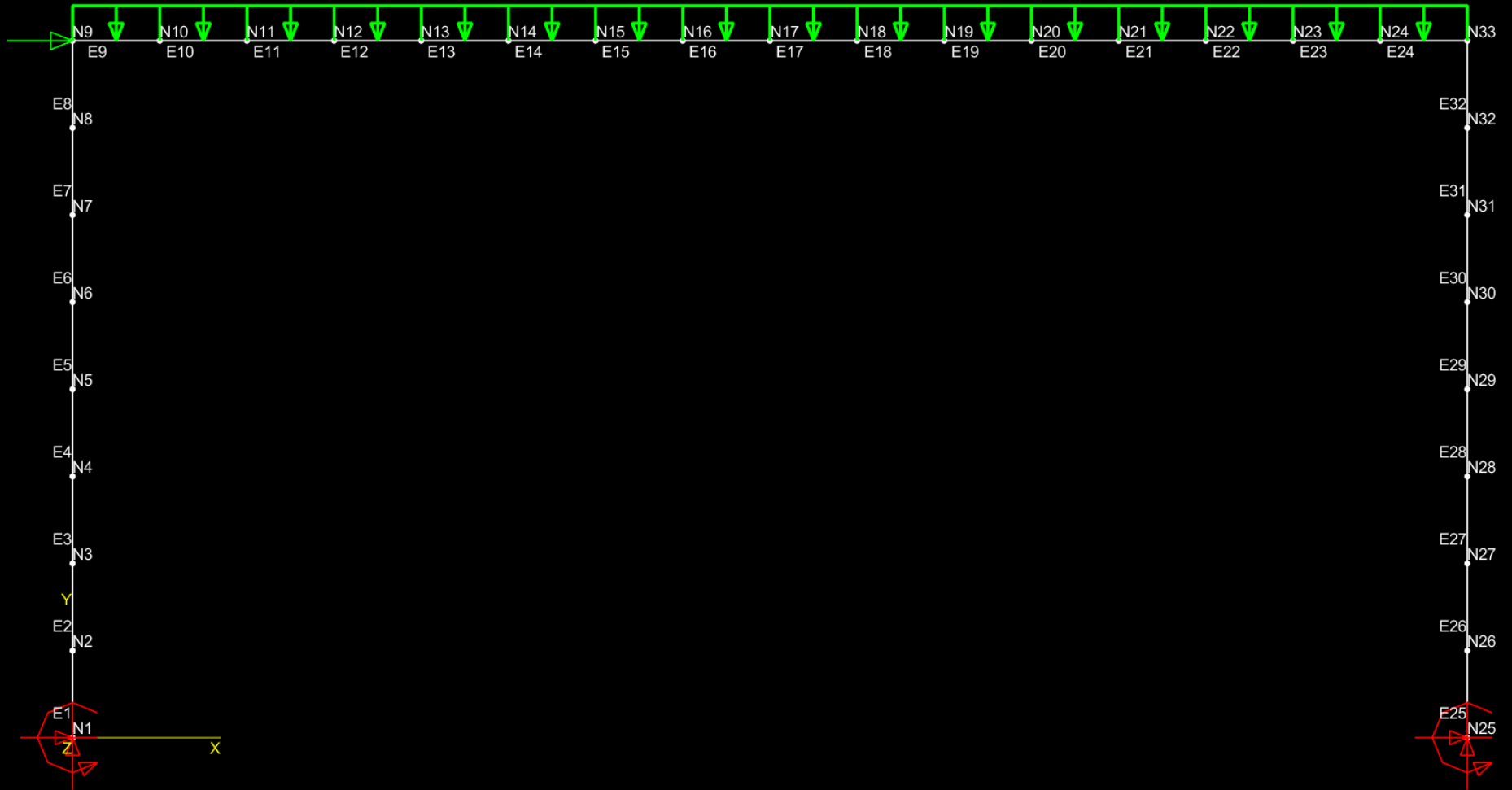

Second-Order Elastic Static Analysis	Status:	Incr # 10, Applied Load Ratio = 1.000 --> Success: Analysis Complete					
Solution Type:	Predictor-Corrector	Incr Size:	0.1	Max. # of Incrs:	10	Max. Appl. Ratio:	1
Analysis Type:	Planar Frame (x-y)	<input type="checkbox"/> [Kff]	Start New	Apply	Cancel		



MASTAN2

MASTAN2: C:\Users\SSIRL\Desktop\Fram.mat [14:44]

File View Geometry Properties Conditions Analysis Results



Node:	33	Disp X:	2.852	Disp Y:	-0.05354	Disp Z:		Status:	Success: Disp. at ALR = 1.0000
Displacements:	Rot X:		Rot Y:		Rot Z:	0.01243	(10) 1.000	Apply	Cancel



Section 4: 3-D Frame Analysis

Updating for 3-D Analysis

As is, the model could be run in 3-D. Previously having entered the complete section properties and applying full fixity to the base support nodes would be satisfactory to meet the requirements to run a 3-D analysis. However, this model would be missing the lateral support of the beam previously mentioned in the problem statement. Before proceeding, we will add that support to the frame through additional boundary conditions.

- 1) From the **Conditions** menu select **Define Fixities**.
- 2) At the bottom menu bar, define the lateral support by clicking in the **check box** to the left of **Z-disp**.
- 3) Create the list of nodes to be assigned these fixities by clicking on the top corner and middle nodes of the model: **9, 17**, and **33**.
- 4) Click on the **Apply** button. 
- 5) From the **View** menu select **Defined Views** and submenu option **Isometric: x-y-z**. 



MASTAN2

MASTAN2: C:\Users\SSIRL\Desktop\Fram.mat [14:44]

File View Geometry Properties Conditions Analysis Results

Please select node(s) and fixity(s) Node(s): 9 17 33 All Clr Adv Status: Success: Node fixities defined.

X-disp Y-disp Z-disp X-rot Y-rot Z-rot Apply Cancel



MASTAN2

MASTAN2: C:\Users\SSIRL\Desktop\Fram.mat [14:44]

File View Geometry Properties Conditions Analysis Results

Please select node(s) and fixity(s) Node(s): 9 17 33 All Clr Adv Status: Success: Node fixities defined.

X-disp Y-disp Z-disp X-rot Y-rot Z-rot Apply Cancel



3-D Second-Order Elastic Analysis

- 1) From the **Analysis** menu select **Static** and submenu option **2nd-Order Elastic**.
- 2) At the bottom menu bar, click on the pop-up menu just to the right of **Analysis Type:** and Select **Space Frame**.
- 3) Click on the **Apply** button to perform the analysis. 

The analysis should stop with the message **Analysis Halted: Limit Reached**. Often this message is related to the analysis encountering a stability limit. The use of the eigen-buckling tool may help identify the problem.



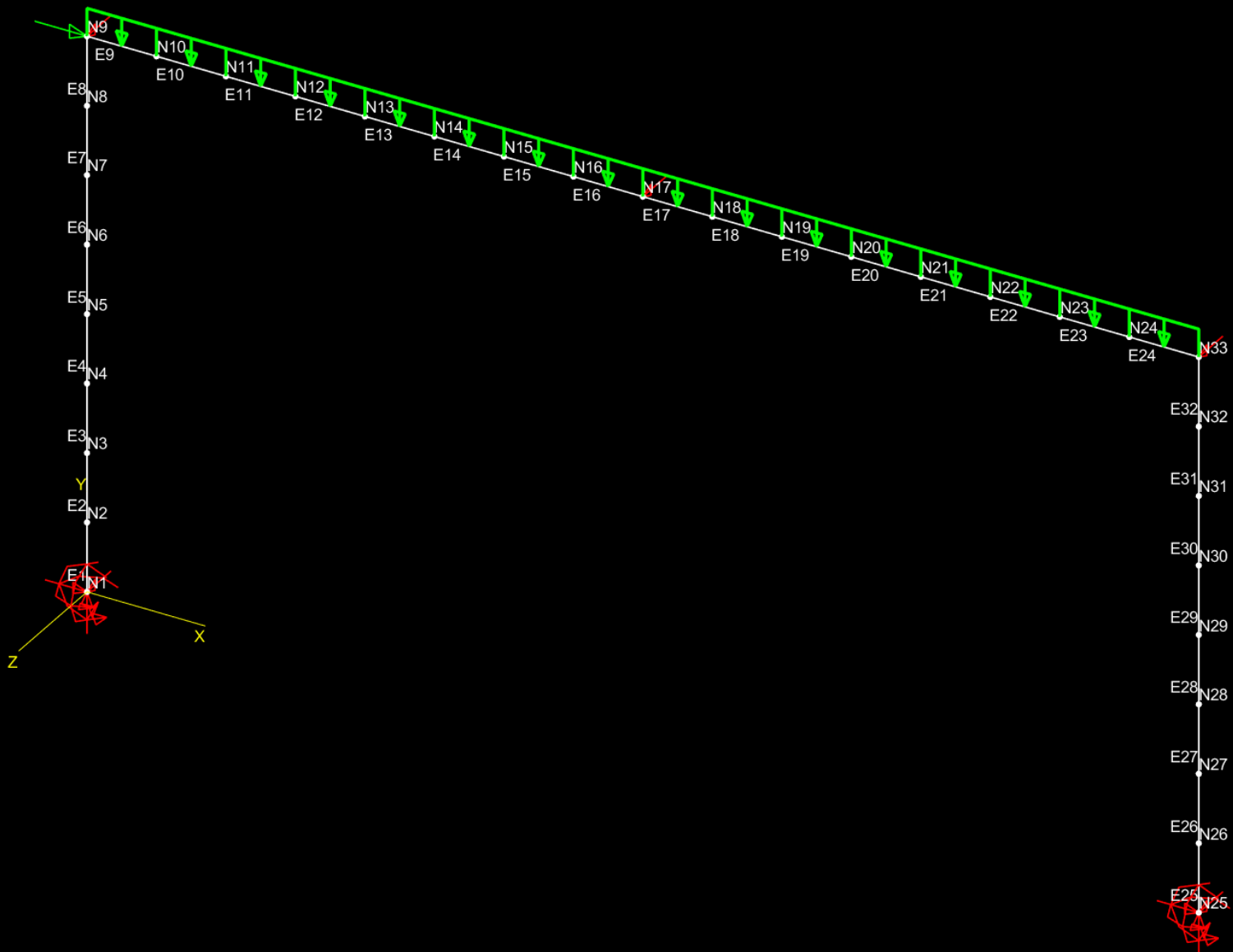



Second-Order Elastic Static Analysis	Status:	Incr # 7, Applied Load Ratio = 0.700 --> Analysis Halted: Limit Reached					
Solution Type:	Predictor-Corrector	Incr Size:	0.1	Max. # of Incrs:	10	Max. Appl. Ratio:	1
Analysis Type:	Space Frame	<input type="checkbox"/> [Kff]	Start New	Apply	Cancel		



3-D Elastic Critical Load

- 1) From the **Analysis** menu select **Eigen-Buckling** and submenu option **Elastic Critical Load**.
- 2) At the bottom menu bar, the **Analysis Type:** should already be set to **Space Frame** with the **Max. # of Modes:** set to **1** as desired.
- 3) Click on the **Apply** button to perform the analysis. 
- 4) From the **Results** menu select **Diagrams** and submenu option **Deflected Shape**.
- 5) At the bottom menu bar, click the edit box to the right of **Scale**. Change **10** to **30** to amplify the deformed geometry in the visualization.
- 6) Click on the **Apply** button and the first mode is shown with the Applied Load Ratio identified at the top of the screen. 

The result indicates that the beam is failing in lateral torsional buckling at only 0.687 times the applied load. Currently, the analysis does not include the warping stiffness which increases the buckling capacity of the beam. MASTAN2 can account for warping effects if the element's warping end conditions are changed.



MASTAN2: C:\Users\SSIRL\Desktop\Fram.mat [14:44]

File View Geometry Properties Conditions Analysis Results

Elastic Critical Load Analysis Status: # of Modes Calculated = 1 ----> Success: Analysis Complete

Analysis Type: Space Frame Max. # of Modes: < 1 > Apply Cancel



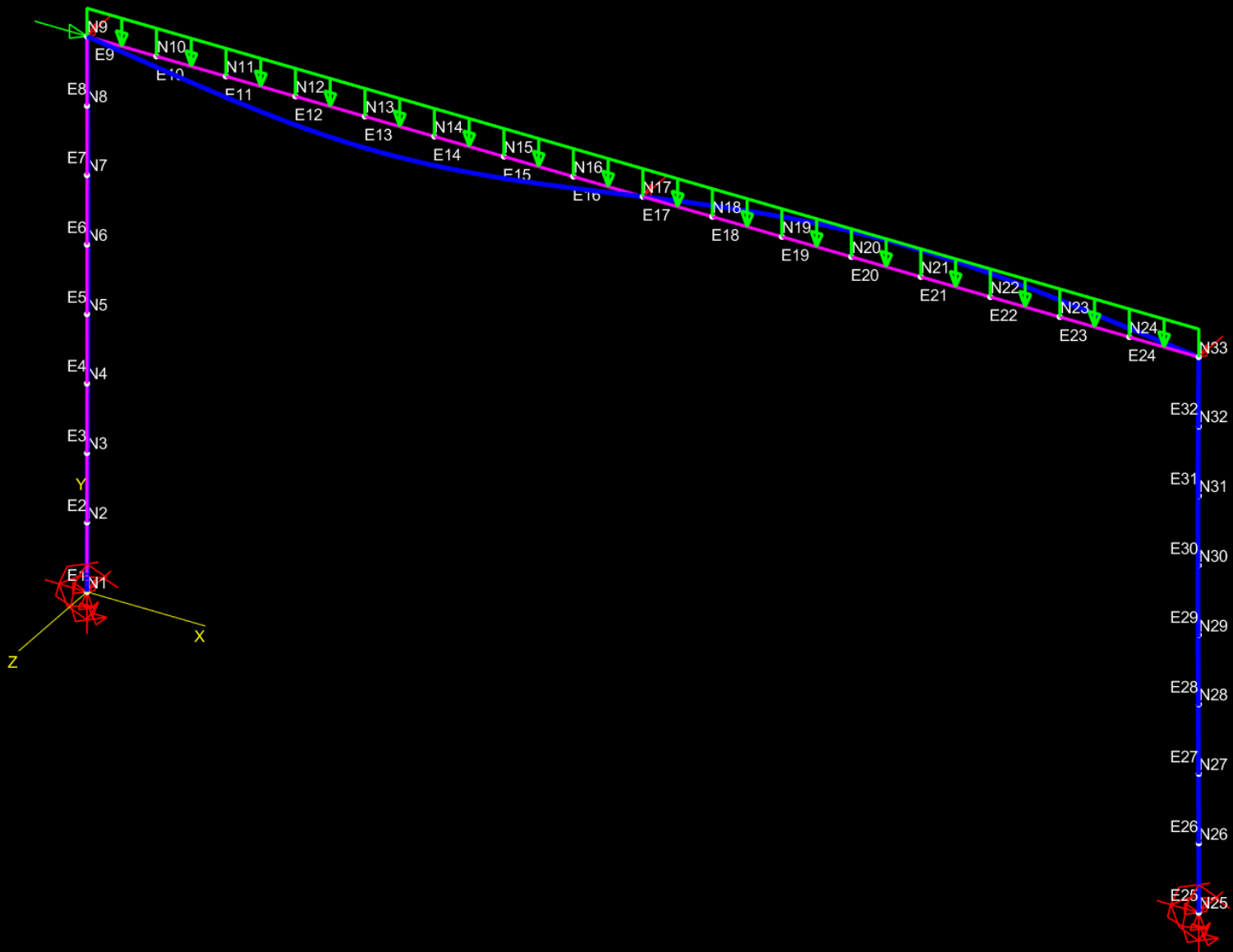

Deflected Shape: Elastic Critical Load, Mode # 1, Applied Load Ratio = 0.68709



Define element(s) and parameters		Element(s):	All	All	Clr	Adv	Status:	Success: Deflection shown
Defl Line Type	Solid	Scale	30	# of pts	10	<input type="checkbox"/> Animate	(1) 0.687	Apply Cancel



Adding Warping Effects

- 1) From the **Geometry** menu select **Define Connections** and submenu option **Torsion**.
- 2) At the bottom menu bar, click on the menu to the right of **Warping Restraint for Node i** and set the value to **Continuous**. Repeat this for the **Warping Restraint for Node j**.
- 3) Create the list of elements to be assigned continuous warping by clicking on the **All** button to the right of **Elements:**. Click on the **Apply** button. Note: no symbol indicates the end is free to warp, a blue + indicates continuous warping, and a blue * indicates fixed warping. 
- 4) Click **Clr** to empty the list of elements. Click on the bottom element of each column and left end element of the beam to define the members that start with warping fixed and are continuous.
- 5) Click on the menu to the right of **Warping Restraint for Node i** and set the value to **Fixed**. Node j is set from the previous step. Click on the **Apply** button. 
- 6) Click **Clr** to empty the list of elements. Click on the top element of each column and right end element of the beam.
- 7) Click on the menu to the right of **Warping Restraint for Node i** and set the value to **Continuous**. Click on the menu to the right of **Warping Restraint for Node j** and set the value to **Fixed**.
- 8) Click on the **Apply** button. 



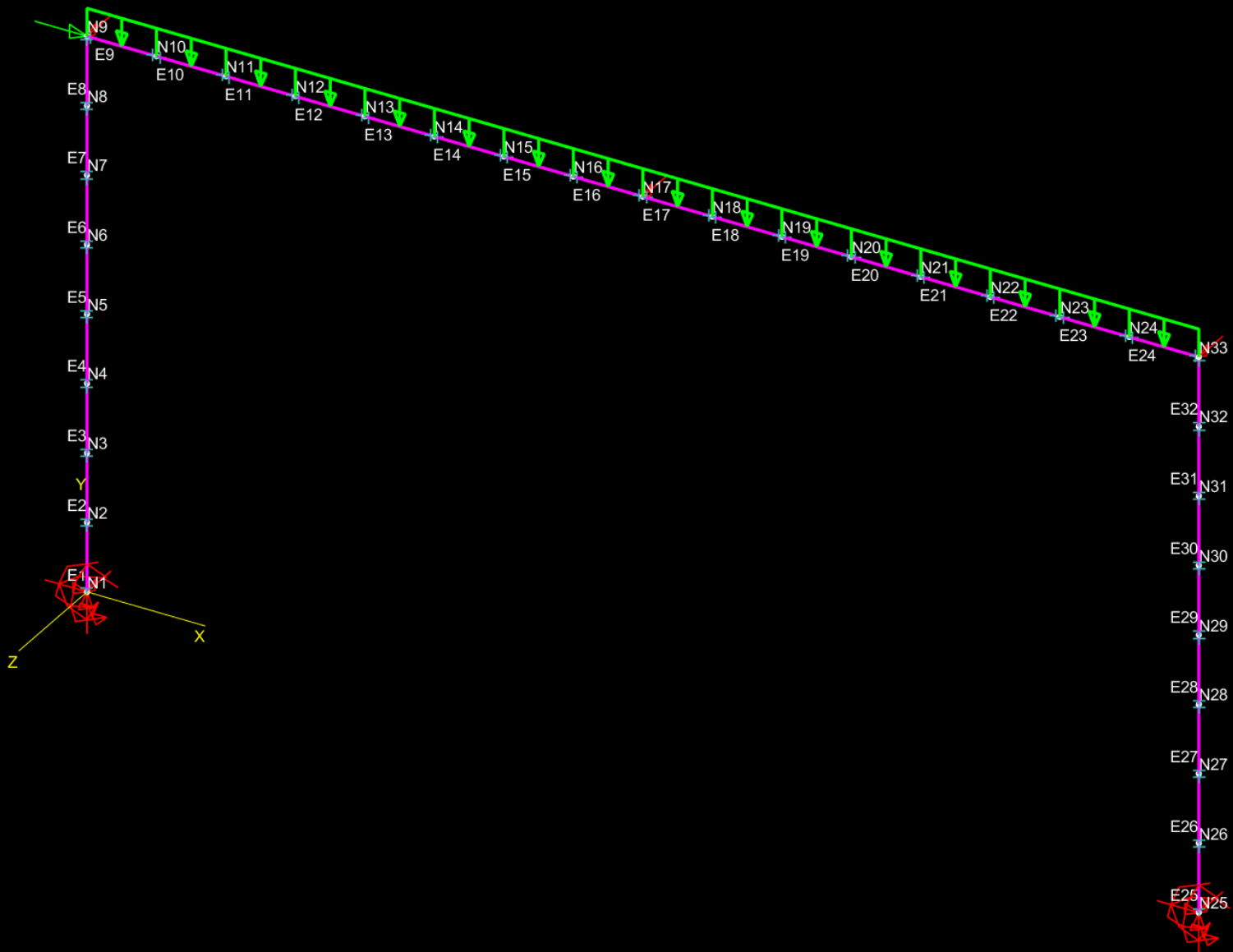

Define element(s) and warping restraint	Element(s):	All	All	Clr	Adv	Status:	Success: Warping Restraint defined.
Node i	Warping Restraint	Continuous	Node j	Warping Restraint	Continuous	Apply	Cancel



MASTAN2

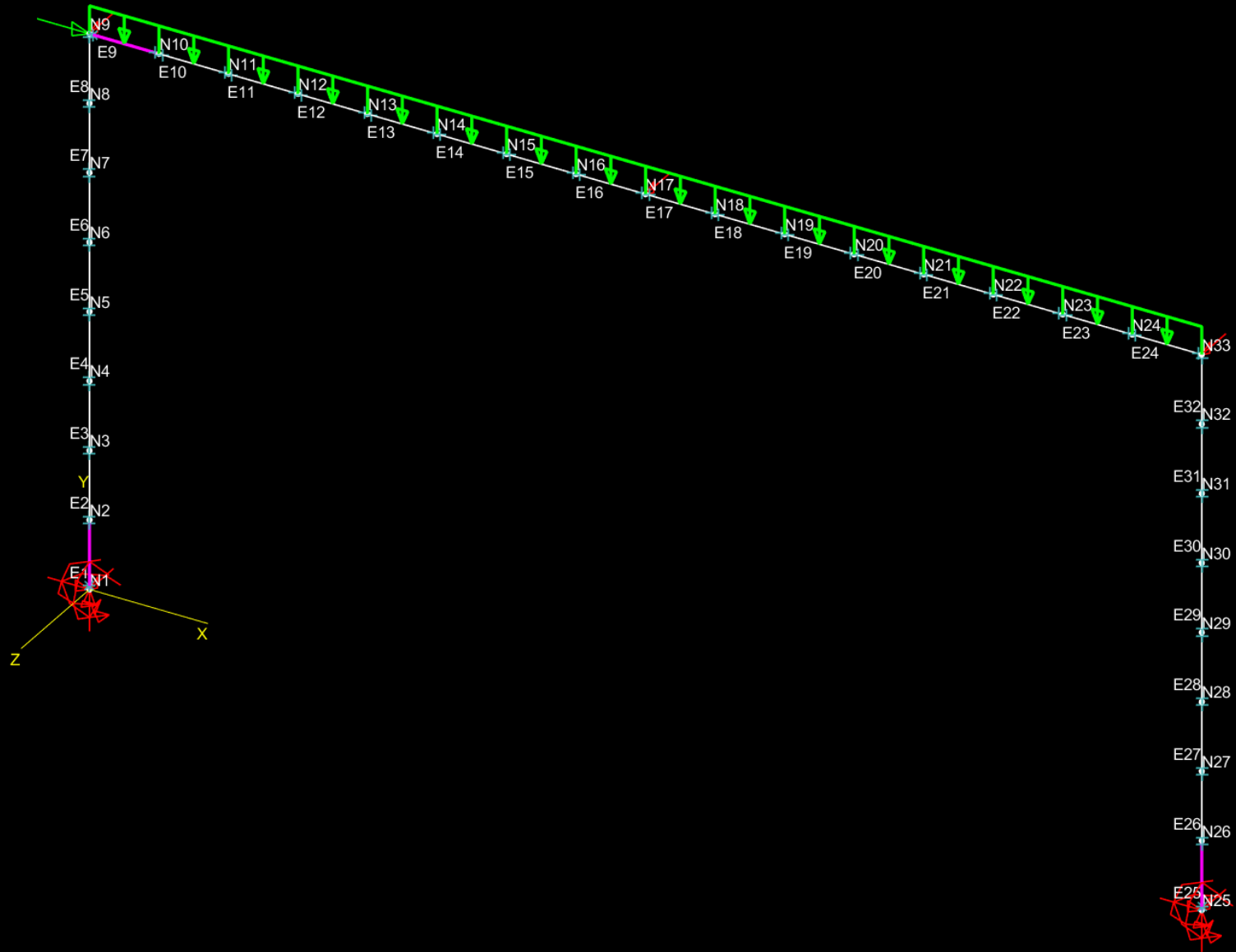

Define element(s) and warping restraint		Element(s):	1 25 9	All	Clr	Adv	Status:	Success: Warping Restraint defined.	
Node i	Warping Restraint	Fixed	Node j	Warping Restraint	Continuous		Apply	Cancel	



MASTAN2

MASTAN2: C:\Users\SSIRL\Desktop\Fram.mat [14:44]



File View Geometry Properties Conditions Analysis Results

Define element(s) and warping restraint Element(s): 8 24 32 All Clr Adv Status: Success: Warping Restraint defined.

Node i	Warping Restraint	Continuous	Node j	Warping Restraint	Fixed	Apply	Cancel
--------	-------------------	------------	--------	-------------------	-------	-------	--------



3-D Elastic Critical Load

- 1) From the **Analysis** menu select **Eigen-Buckling** and submenu option **Elastic Critical Load**.
- 2) At the bottom menu bar, the **Analysis Type:** should already be set to **Space Frame** with the **Max. # of Modes:** set to **1** as desired.
- 3) Click on the **Apply** button to perform the analysis. 
- 4) From the **Results** menu select **Diagrams** and submenu option **Deflected Shape**.
- 5) At the bottom menu bar, the **Scale** should still be set to **30** from previous analysis.
- 6) Click on the **Apply** button and the first mode is shown with the Applied Load Ratio identified at the top of the screen. 

The result indicates that the beam is failing in lateral torsional buckling at 1.31 times the applied load. This value is 1.9 times the result when ignoring the effects of warping stiffness. The fact that the Applied Load Ratio is greater than 1 means it should now be possible to complete the desired 3-D 2nd order analysis.



MASTAN2: C:\Users\SSIRL\Desktop\Fram.mat [14:44]

File View Geometry Properties Conditions Analysis Results

Elastic Critical Load Analysis Status: # of Modes Calculated = 1 ----> Success: Analysis Complete

Analysis Type: Space Frame Max. # of Modes: < 1 > Apply Cancel



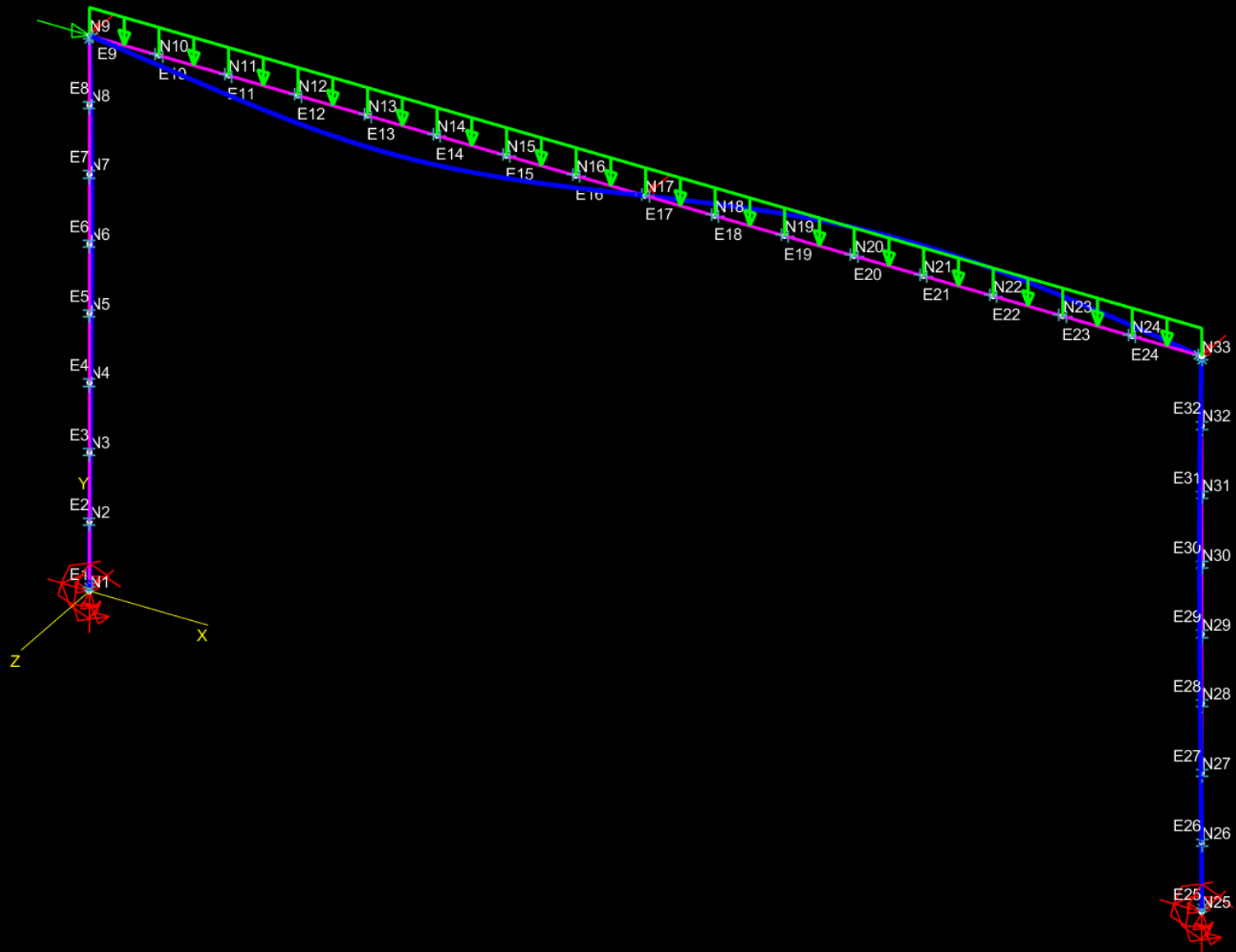

Deflected Shape: Elastic Critical Load, Mode # 1, Applied Load Ratio = 1.3106



Define element(s) and parameters		Element(s):	All	All	Clr	Adv	Status:	Success: Deflection shown	
Defl Line Type	Solid	Scale	30	# of pts	10	<input type="checkbox"/> Animate	(1) 1.311	Apply	Cancel



3-D Second-Order Elastic Analysis

- 1) From the **Analysis** menu select **Static** and submenu option **2nd-Order Elastic**.
- 2) At the bottom menu bar, the **Analysis Type:** should already be set to **Space Frame** as desired.
- 3) Click on the **Apply** button to perform the analysis. 
- 4) From the **Results** menu select **Node Displacements**.
- 5) On the undeflected shape, click on the node of interest in the upper right corner, **33**, and its components are provided in the bottom menu bar. 

Results:

Disp X	Disp Y	Disp Z	Rot X	Rot Y	Rot Z
2.852	-0.05354	0	0	0	0.01243

The deflection response is the same as 2-D as no out-of-plane loading or displacements were added. The same axial and flexural deformations are being modeled. The introduction of the 3-D analysis highlighted the existing out-of-plane instability and the analysis could not proceed past the bifurcation load in the perfect model.



MASTAN2: C:\Users\SSIRL\Desktop\Fram.mat [14:44]

File View Geometry Properties Conditions Analysis Results

Second-Order Elastic Static Analysis Status: Incr # 10, Applied Load Ratio = 1.000 --> Success: Analysis Complete

Solution Type: Predictor-Corrector Incr Size: 0.1 Max. # of Incrs: 10 Max. Appl. Ratio: 1

Analysis Type: Space Frame [Kff] Start New Apply Cancel



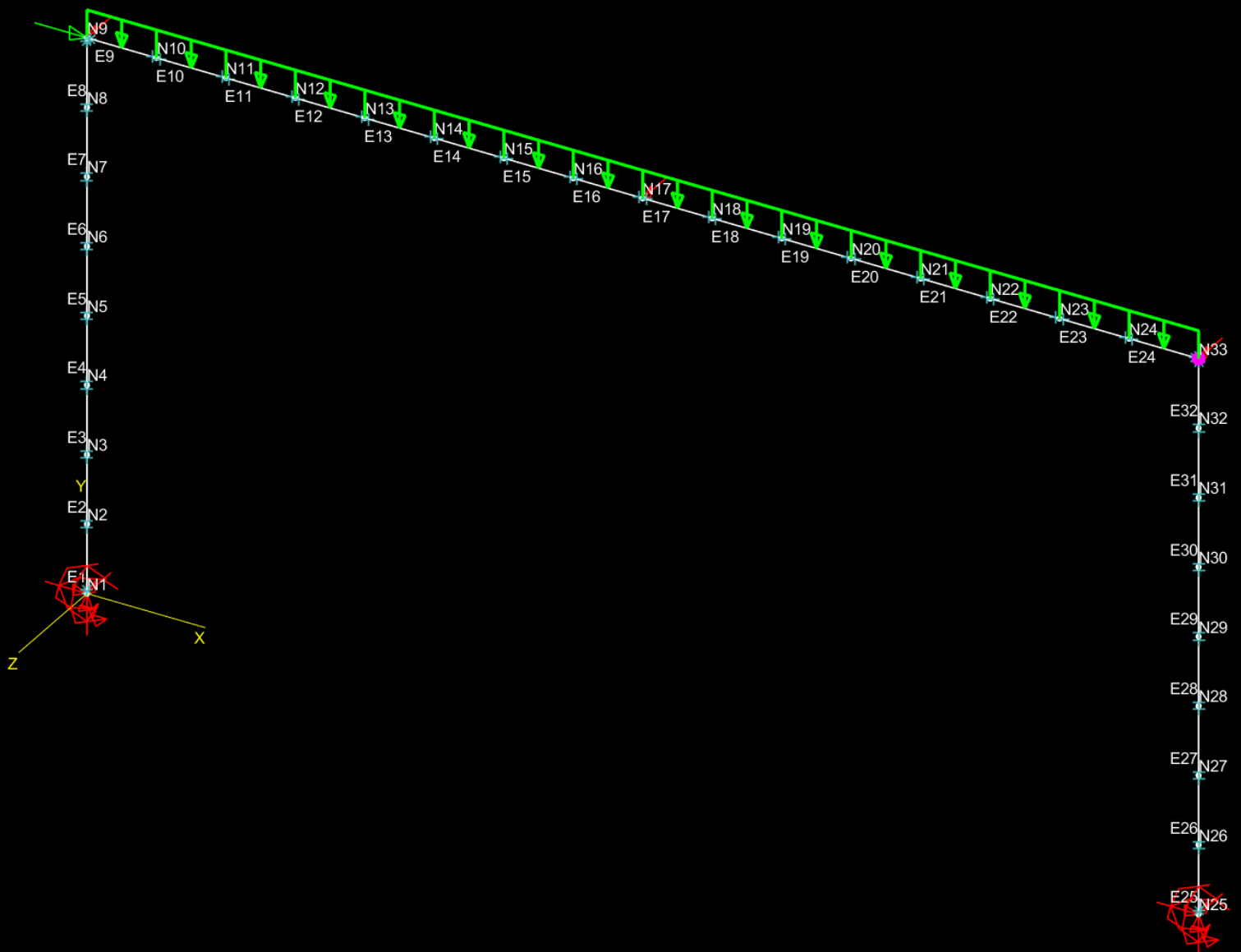

Node:	33	Disp X	2.852	Disp Y	-0.05354	Disp Z	0	Status:	Success: Disp. at ALR = 1.0000
Displacements	Rot X	0	Rot Y	0	Rot Z	0.01243	(10) 1.000	Apply	Cancel



Section 5: Using MSAsect

MSASect

The section properties used so far have been for doubly symmetric cross sections where we would have looked up the values or calculated them outside the program for ourselves. The updated version of MASTAN2 includes a new tool MSASect that can calculate section properties for thin wall cross sections. MSASect can be used with open and closed cross sections whether symmetric or not. In addition to the section properties used thus far, MSASect will calculate the necessary non-doubly symmetric section properties. The tool is found within the **Define Section** and **Modify Section** menu. As a demonstration, the section properties of a W27x84 cross section will be found.





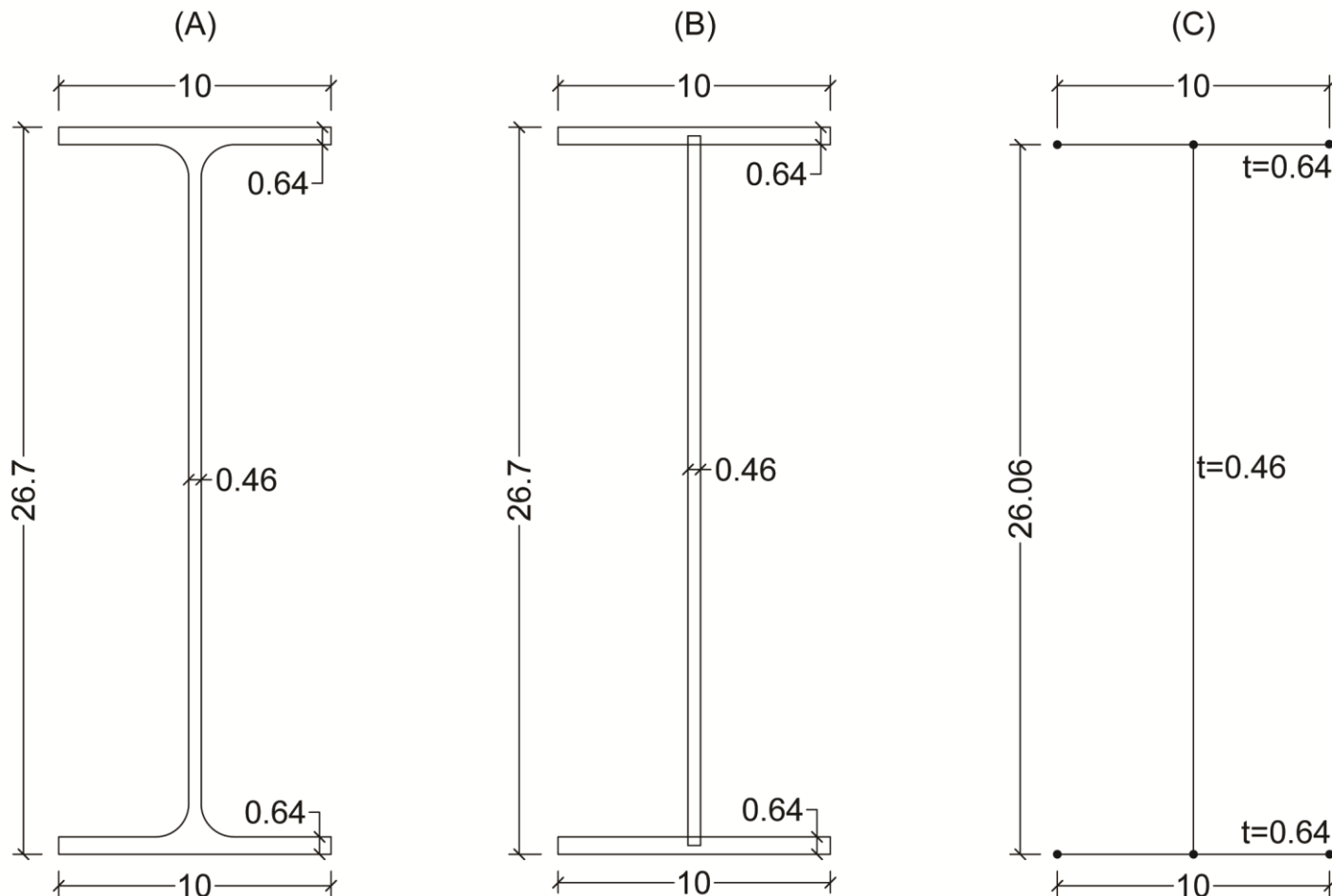

Cross Section Geometry

The W27x84 cross section is shown below. Figure A illustrates the full cross section with fillets that is associated with the AISC table values. Figure B illustrates the simplified section with overlap and no fillets that represents the cross section to be calculated by MSASect. These are the dimensions to be entered when working with the template. Figure C illustrates the resulting node to node model created when using the template that will be used for calculations in MSASect.



Using MSA Sect

- 1) From the **Properties** menu select **Define Section**.
- 2) At the bottom menu bar, click on the pop-up menu on the far right that currently displays **Basic**.
Click on **Advanced** and new edit boxes and buttons should appear. 
- 3) Click on **MSASect**. 
- 4) As the I-beam cross-section is selected by default, click the edit box to the right of **B1=** and enter **10**. Repeat to define **B2=10**, **D=26.7**, **t1=0.64**, **t2=0.64**, and **t3=0.46**.
Note: The dimensions to enter in the template correspond to Figure B on the previous page. While the section property calculations need to be completed using the dimensions shown in Figure C, this information is automatically generated based on the assumption that the numbers provided followed Figure B.
- 5) Click **Calculate** to determine the properties. 
- 6) Click edit box to right of **Name:** and enter **W27x84Hand**.
- 7) Click **Export to MASTAN2** to copy values to main program.
- 8) Click **Close** to return to the main window. There will often be a confirmation when closing it. 
- 9) Click **Apply** to define Section 3. 



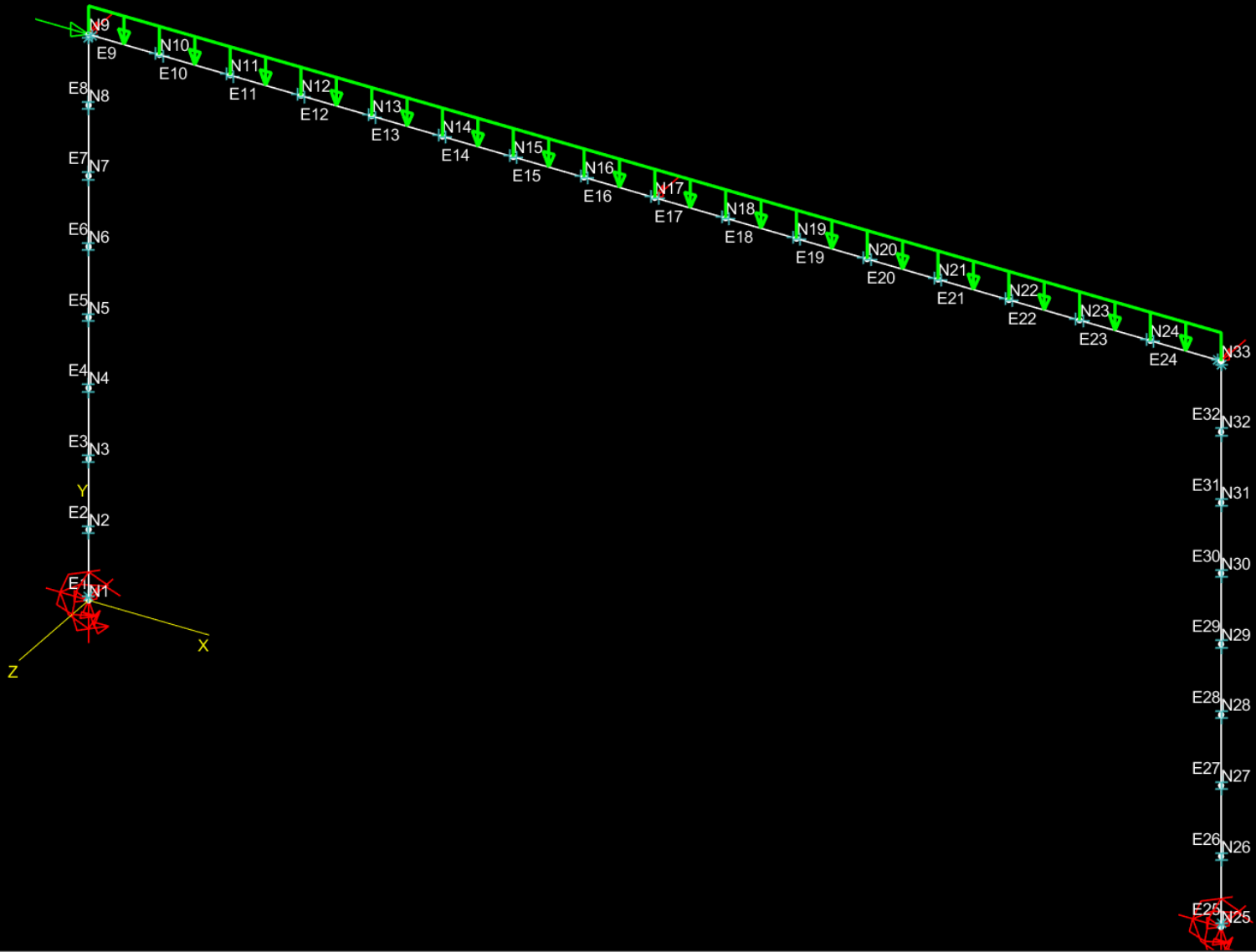

Please enter section properties		Section 3		Name:		MSASect		Status:	
Area =	0	I z-z =	0	I y-y =	0	J =	0	Cw =	0
Ysc =	0	Zsc =	0	BetaV =	0	BetaW =	0	Betaw =	0
Z w-w =	inf	Z v-v =	inf	A v-v =	inf	A w-w =	inf	Advanced	
								Apply	Cancel



MSASect (Nonsymmetric Section)

Section Type

Mono-Symmetric I T-Shape Z-Shape
 C-Shape L-Shape Elli-Shape
 Rec-Shape Trap-Shape General

Dimensions

B1=		t1=	
B2=		t2=	
D=		t3=	

 Database

Section View

(+) \leftarrow Z \rightarrow (-)
 (-) \leftarrow Y \rightarrow (+)

Section Properties Name: Phi= Status:

Area =	I z-z =	I y-y =	J =	Cw =
Ysc =	Zsc =	BetaV =	BetaW =	Betaw =
Z w-w =	Z v-v =	A v-v =	A w-w =	I y-z =



MSASect (Nonsymmetric Section)

Section Type

Mono-Symmetric I T-Shape Z-Shape
 C-Shape L-Shape Elli-Shape
 Rec-Shape Trap-Shape General

Dimensions

B1=	10	t1=	0.64
B2=	10	t2=	0.64
D=	26.7	t3=	0.46

 Database

Section View

(+) <----- Z ----- (-)
 (-) <----- Y ----- (+)

Section Properties Name: Phi= 0 Status: **Calculated successfully!**

Area =	2.479e+01	I z-z =	2.852e+03	I y-y =	1.069e+02	J =	2.593e+00	Cw =	1.811e+04
Ysc =	0	Zsc =	0	BetaV =	0	BetaW =	0	Betaw =	0
Z w-w =	2.449e+02	Z v-v =	3.200e+01	A v-v =	1.228e+01	A w-w =	1.067e+01	I y-z =	-6.395e-13



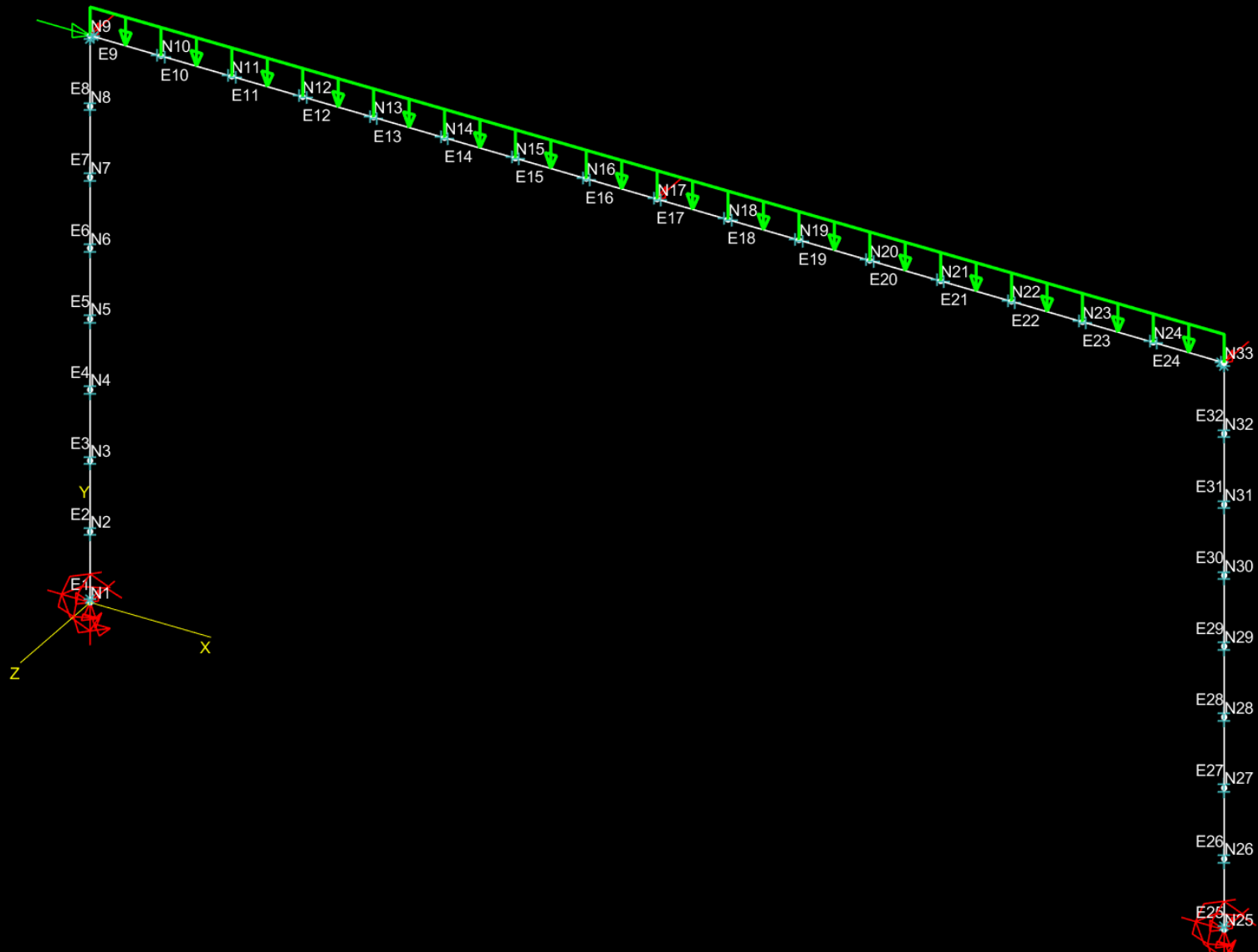

Please enter section properties		Section 3	Name:	W27x84Hand	MSASect	Status:					
Area =	24.7876	I z-z =	2852.05	I y-y =	106.878	J =	2.59315	Cw =	18110	I y-z =	-6.39488e-13
Ysc =	0	Zsc =	0	BetaV =	0	BetaW =	0	Betaw =	0	Advanced ▾	
Z w-w =	244.883	Z v-v =	32	A v-v =	12.282	A w-w =	10.6667	Apply		Cancel	



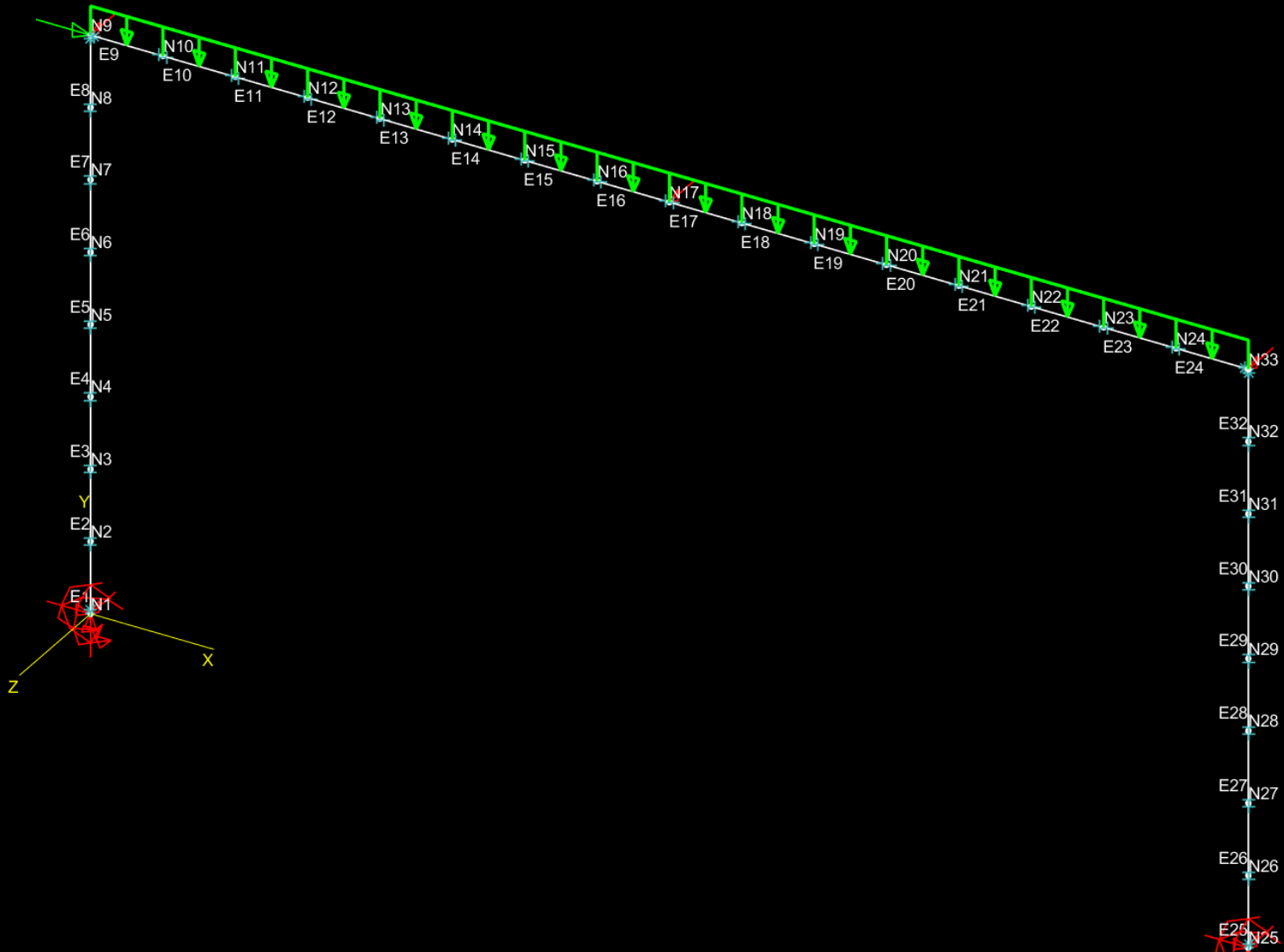

Please enter section properties		Section 4		Name:		MSASect		Status:		Success: Section 3 defined.	
Area =	0	I z-z =	0	I y-y =	0	J =	0	Cw =	0	I y-z =	0
Ysc =	0	Zsc =	0	BetaV =	0	BetaW =	0	Betaw =	0	Advanced ▾	
Z w-w =	inf	Z v-v =	inf	A v-v =	inf	A w-w =	inf	Apply		Cancel	



MSASect Results

- 1) From the **Properties** menu select **Information** and submenu option **Section**.
- 2) Change the **Section #** by clicking on the current section number just to the right to open a pop-up menu with all section numbers. Click on **2** to view the Section Properties based on the AISC database. Repeat with clicking on **3** to see the MSASect calculated values. 

Property	Units	AISC	MSASect	Difference
A	in ²	24.7	24.79	0.4 %
Izz	in ⁴	2850	2852	0.1 %
Iyy	in ⁴	106	106.9	0.8 %
J	in ⁴	2.81	2.59	-7.7 %
Cw	in ⁶	18000	18110	0.6 %
Zzz	in ³	244	244.9	0.4 %
Zyy	in ³	33.2	32	-3.6 %

From the comparison of section properties from AISC and the values calculated by MSASect, most of the calculated properties match well. Take note that some of the template shapes calculate standard shear area values. To match the previous analysis, the **A v-v** and **A w-w** would need to be set to **inf**.



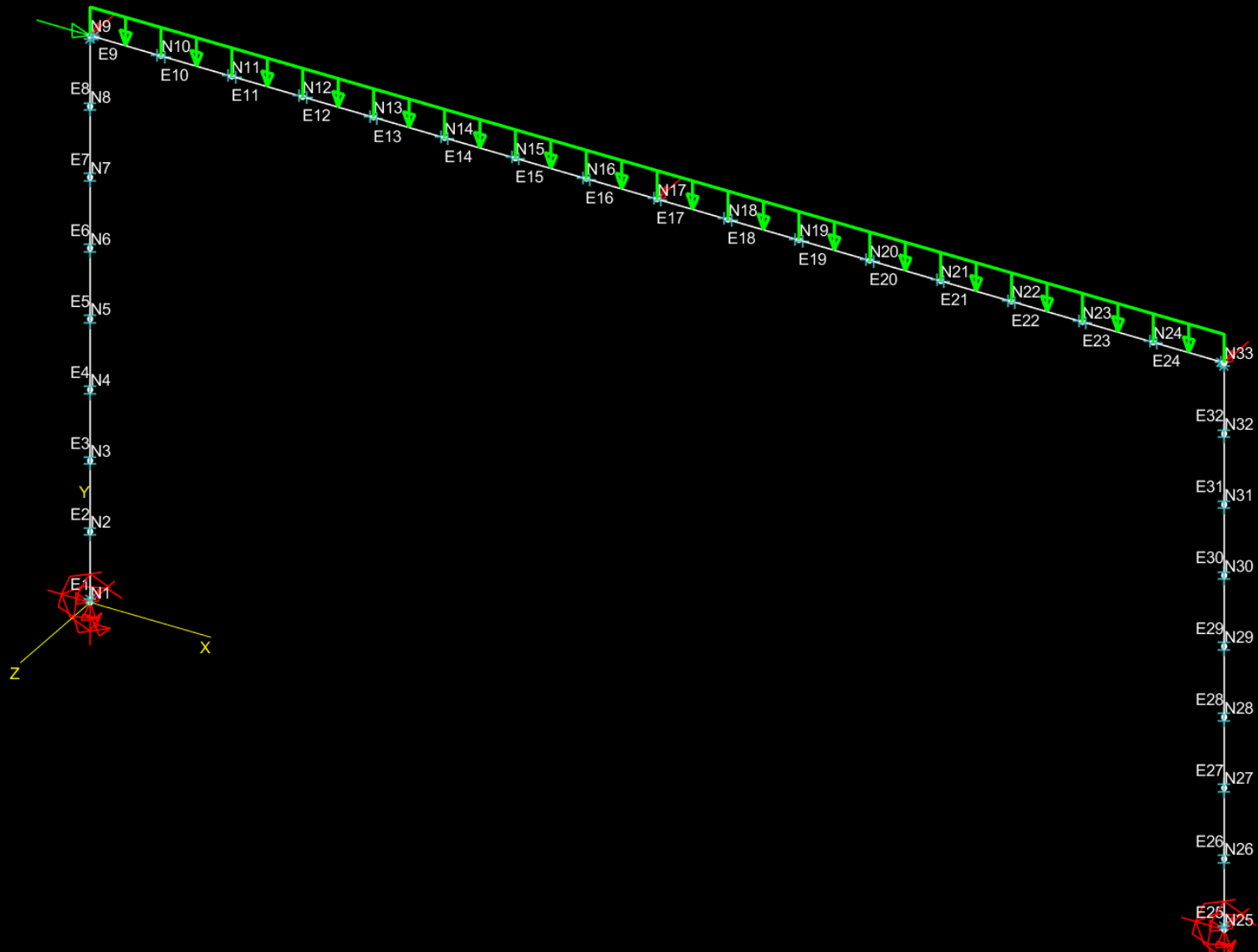

Select Section # for information		Section #	3	Name:	W27x84Hand	Status:	Success: Section 3 displayed				
Area =	24.7876	I z-z =	2852.05	I y-y =	106.878	J =	2.5932	Cw =	18110	I y-z =	-6.3949e-13
Ysc =	0	Zsc =	0	BetaV =	0	BetaW =	0	Betaw =	0	Phi =	0
Z w-w =	244.883	Z v-v =	32	A v-v =	12.282	A w-w =	10.6667	Cancel			



Using MSA Sect

If one of the default cross sections does not cover your situation the General option allows for the input of nodes and line segments by the user. Clicking the radio button next to **General** and then the **Next** button will open an interface that allows for the input of nodes and line segments directly. If you want to verify the final node coordinates used or tweak a default geometry, click **Convert to General** to gain access to the list of nodes and line segments automatically created in the MSASect interface. The following is an example of what the W24x87 would look like. Note that the coordinates correspond with Figure C shown previously. 

MSASect (Nonsymmetric Section)

-Nodes-

1	ID:	1	Add
2	Z-Coord. =	5	Modify
3	Y-Coord. =	13.03	Delete
4			
5			

-Segments-

1	ID:	1	Add
2	Start Node =	1	Modify
3	End Node =	2	Delete
4	Thickness =	0.64	
5			

Section View

Calculate Beta = 45 Rotate

Section Properties Name: Phi = 0 Status:

Area =	2.479e+01	I z-z =	2.852e+03	I y-y =	1.069e+02	J =	2.593e+00	Cw =	1.811e+04
Ysc =	0	Zsc =	0	BetaV =	0	BetaW =	0	Betaw =	0
Z w-w =	2.449e+02	Z v-v =	3.200e+01	I y-z =	-6.395e-13				

Reset Open Save Save As Export to Mastan2 Cancel





Section 6: Frame Analysis with Non-Doubly Symmetric Sections

Problem Description - Figure

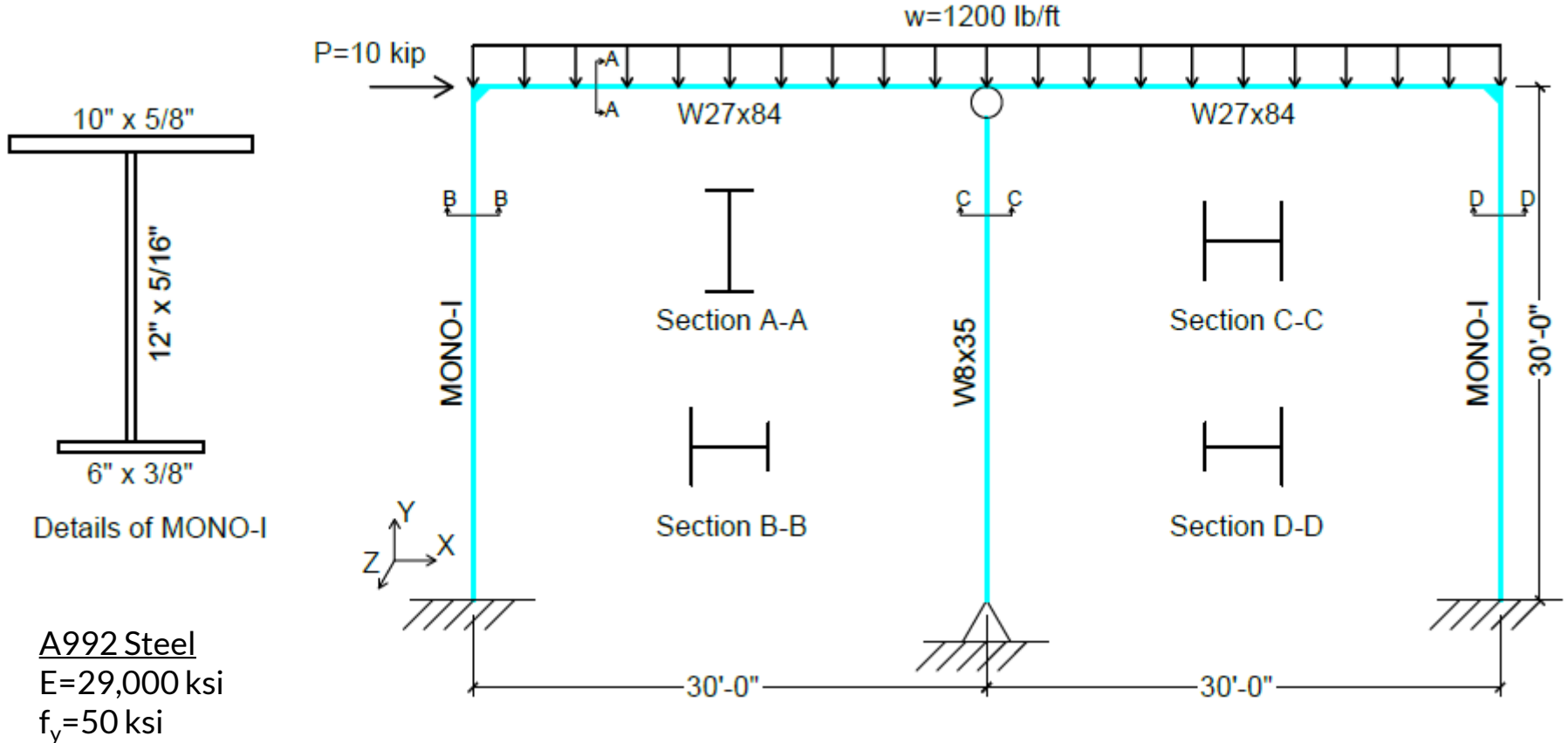
The frame is constructed of A992 steel with the properties indicated. The frame is also supported out of plane in the Z direction on the beam at the column locations. The outer columns and top beam are assumed to be fixed for warping at the end. The beam is also continuous for warping over the middle column. The middle column is assumed to be free to warp at each end.



Adding Interior Column

- 1) From the **Geometry** menu select **Define Node**.
- 2) At the bottom menu bar, click in the edit box to the right of **x =** and enter **360**. Click in the edit box to the right of **y =** and enter **0**. Click in the edit box to the right of **z =** and enter **0**.
- 3) Click on the **Apply** Button. 
- 4) From the **Geometry** menu select **Define Element**.
- 5) On the model, click the newly created node to define Node i. Then click the middle node of the top beam to define Node j. These nodes should be **34** and **17**, respectively.
- 6) Click on the **Apply** Button. 



MASTAN2

MASTAN2: C:\Users\SSIRL\Desktop\Fram.mat [14:44]

File View Geometry Properties Conditions Analysis Results

Please enter coordinates of node

x =	360	y =	0	z =	0
-----	-----	-----	---	-----	---

Status: Success: Node 34 defined.

Apply Cancel



MASTAN2

MASTAN2: C:\Users\SSIRL\Desktop\Fram.mat [14:44]

File View Geometry Properties Conditions Analysis Results



Please select element end nodes and define beta

Status: Success: Element 33 defined.

Node i Node j Beta (Deg) 0.0 Apply Cancel



Applying Material and Section Properties

- 1) From the **Properties** menu select **Attach Material**.
- 2) Create the list of elements to be assigned the properties of Material 1 by clicking on the new column. Click on the **Apply** button. (Note that elements with assigned just material properties turn dotted.) 
- 3) From the **Properties** menu select **Define Section**.
- 4) At the bottom menu bar, click on the **Database** button.
- 5) In the pop-up menu, scroll to find section **W8x35** and click on it. Then click on the **Apply** button. (Section 4 is now defined with the properties of W8x35.) 
- 6) From the **Properties** menu select **Attach Section**.
- 7) Create the list of elements to be assigned the properties of Section 4 by clicking on the new column, element **33**.
- 8) Change the **Section #** by clicking on the current section number just to the right to open a pop-up menu with all section numbers. Click on **4** to select Section #4, W8x35.
- 9) Assign Section 4 properties by clicking the **Apply** button. 



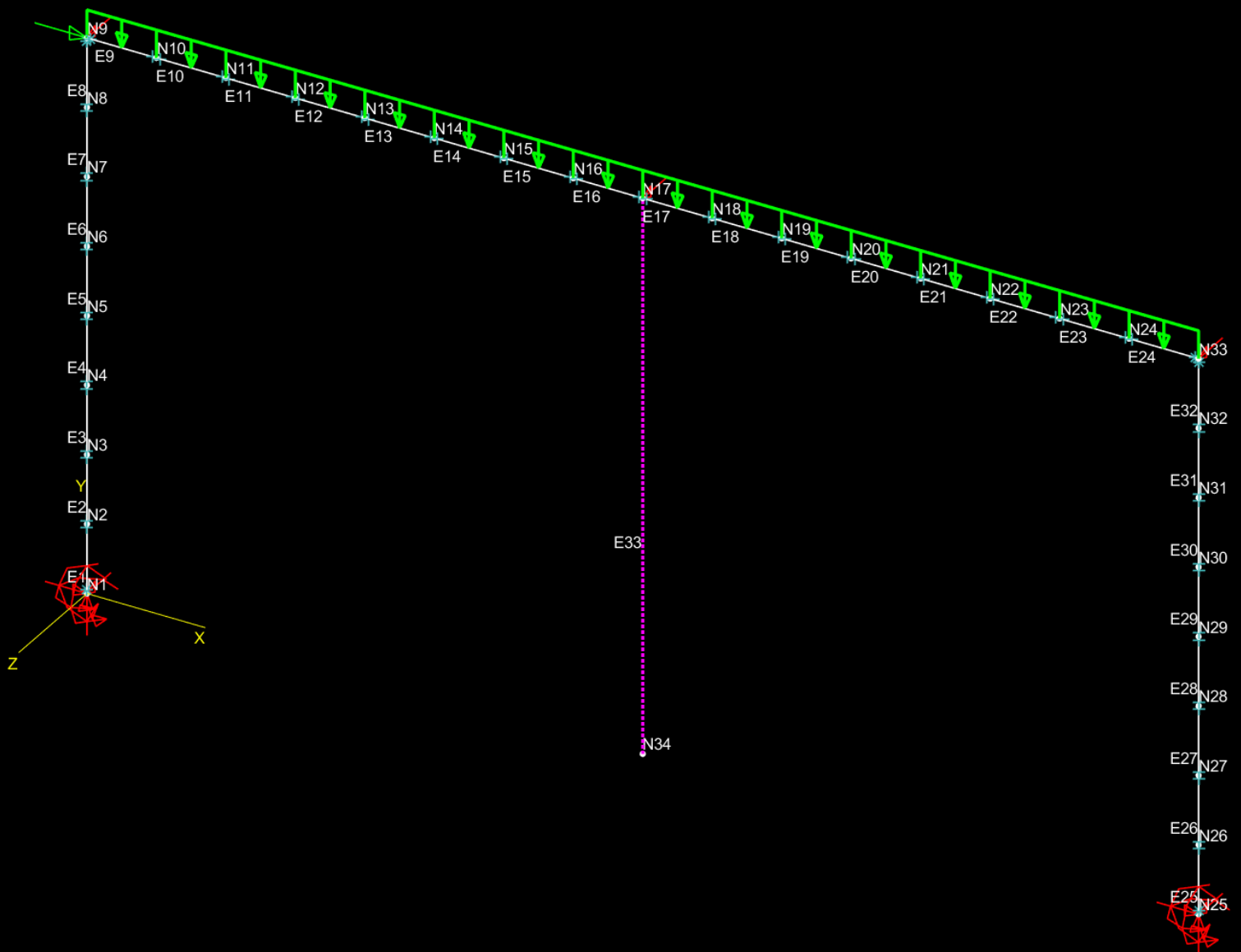

Select Material # and element(s)	Element(s):	33	All	Clr	Adv	Status:	Success: Material attached.
Material #	1	Details: A992	<Click to see properties>			Apply	Cancel



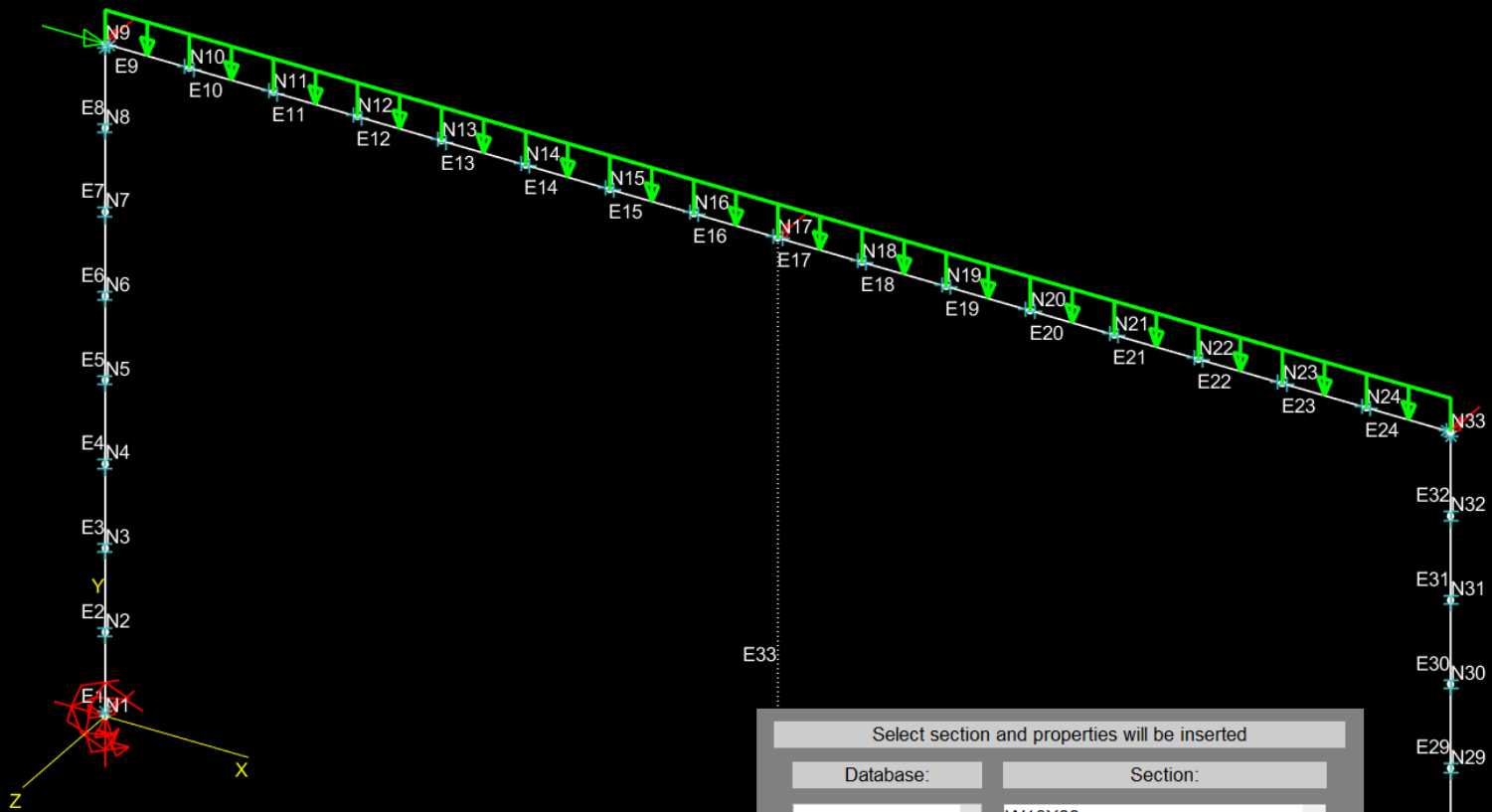

Select section and properties will be inserted

Database:	AISC (in)	Section:	W10X22
Type:	W Shapes		W10X19
Shear Areas:	infinite		W10X17
			W10X15
			W10X12
			W8X67
			W8X58
			W8X48
			W8X40
			W8X35
			W8X31
			W8X28
			W8X24
			W8X21
			W8X18

Please enter section properties		Section 5	Name:		<input checked="" type="radio"/> Database	Status:	Success: Section 4 defined.			
Area =	0	I z-z =	0	I y-y =	0	J =	0	Cw =	0	Basic
Z z-z =	inf	Z y-y =	inf	A y-y =	inf	A z-z =	inf	<input type="button" value="Apply"/> <input type="button" value="Cancel"/>		



MASTAN2: C:\Users\SSIRL\Desktop\Fram.mat [14:44]



File View Geometry Properties Conditions Analysis Results

The image displays the MASTAN2 software interface. The main window shows a structural model of a frame. The frame consists of a vertical column on the left, a horizontal beam at the top, and a vertical member on the right. The nodes are labeled N1 through N34, and the elements are labeled E1 through E33. A purple vertical member E33 is highlighted. The status bar at the bottom shows 'Section # 4' and 'Details: W8X35'. The status bar also includes a dropdown menu for 'Section #', a text field for 'Details: W8X35', and buttons for 'Apply' and 'Cancel'. The status bar also shows 'Status: Success: Section attached.'

Section #	Details	Status
4	W8X35 <Click to see properties>	Success: Section attached.



Element Modification

- 1) From the **Geometry** menu select **Subdivide Element(s)**.
- 2) Create the list of elements by clicking on the new column.
- 3) Click the **>** box to the right of **# of Segments =** to increase **2** to **8**.
- 4) Click on the **Apply** button. (Note that same the section and material property information is given to all new elements.) 
- 5) From the **Conditions** menu select Define **Fixities**.
- 6) At the bottom menu bar, define a pin support by clicking in the **check boxes** just to the left of **X-disp**, **Y-disp**, and **Z-disp**.
- 7) Create the list of nodes to be assigned this fixity by clicking on the middle bottom node, **34**.
- 8) Click on the **Apply** button. 

MASTAN2

MASTAN2: C:\Users\SSIRL\Desktop\Fram.mat [14:44]

File View Geometry Properties Conditions Analysis Results

Please select element(s) and number of segments

Status: Success: Element(s) subdivided.

Element(s): All Clr Adv # of Segments = < 8 > Apply Cancel



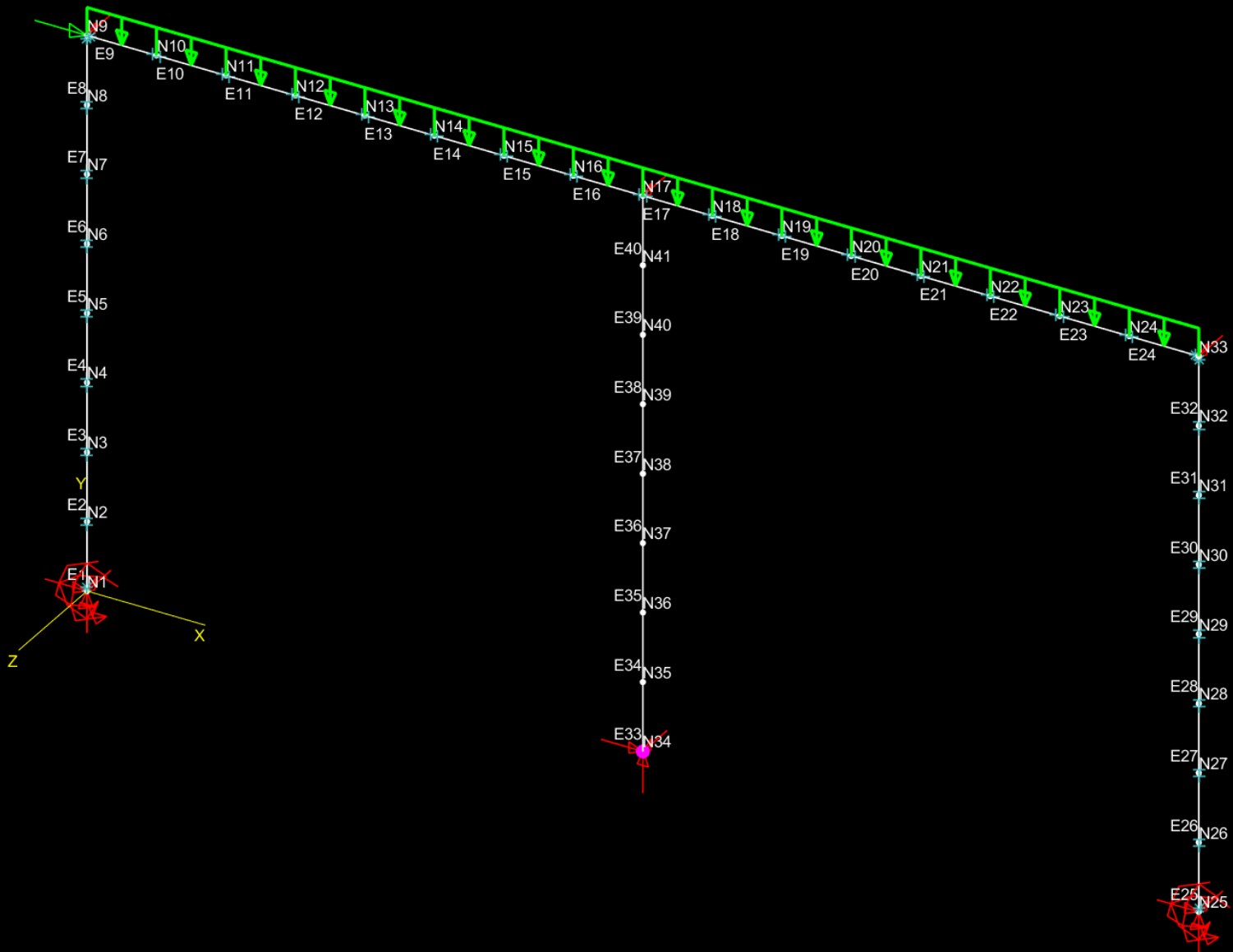

Please select node(s) and fixity(s) Node(s): 34 All Clr Adv Status: Success: Node fixities defined.

X-disp Y-disp Z-disp X-rot Y-rot Z-rot Apply Cancel



Warping Continuity

- 1) From the **Geometry** menu select **Define Connections** and submenu option **Torsion**.
- 2) At the bottom menu bar, click on the menu to the right of **Warping Restraint for Node i** and set the value to **Continuous**. Repeat this for the **Warping Restraint for Node j**.
- 3) Use the buttons to the right of **Element(s)**: to make the list of elements. Click the **Adv** button to open the pop-up menu. To select all the middle column elements, click the **Off** button to the right of **Range (Inclusive)** to turn this tool **On**. Click the edit box to the left of **X** and change **-Inf** to **359**. Click the edit box to the right of **X** and change **Inf** to **361**.
- 4) Click **Add** to add all these elements to the element list. Click on the **Apply** button to assign continuous warping. 

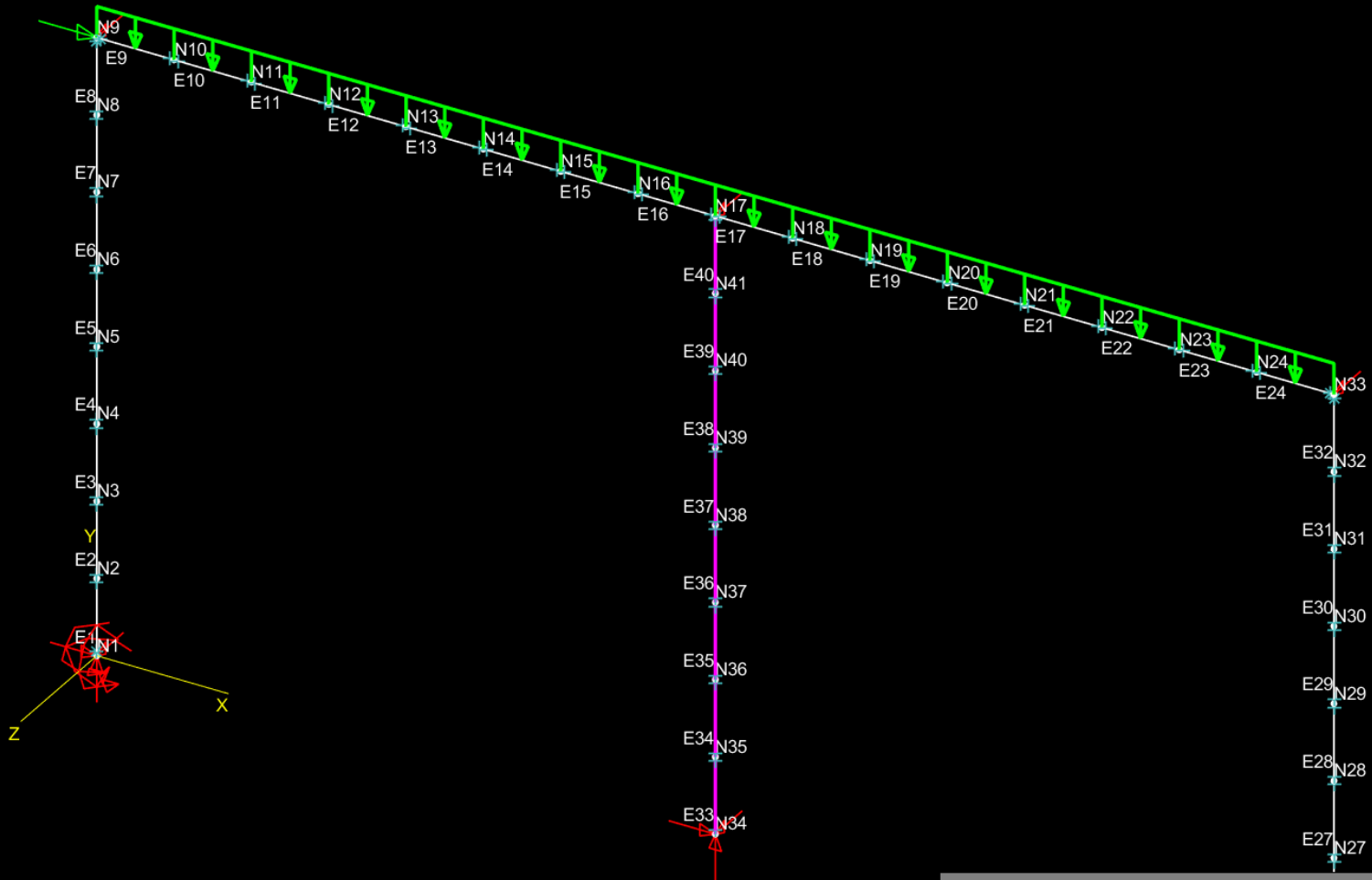

Advanced Element Selection

Parallel to: On

X-axis

Y-axis

Z-axis

Range (Inclusive) On

359	X	361
-inf	Y	+inf
-inf	Z	+inf



Add Remove Reset

Define element(s) and warping restraint Element(s): 33 34 35 36 37 38 39 40 All Clr Adv Status: Success: Warping Restraint defined.

Node i	Warping Restraint	Continuous	Node j	Warping Restraint	Continuous	Apply	Cancel
--------	-------------------	------------	--------	-------------------	------------	-------	--------



Warping Boundary Conditions

- 1) Click **Adv** to close the pop-up menu.
- 2) Click **Clr** to empty the list of elements. Click on the bottom element of the middle column to define the member that start with warping free and is continuous.
- 3) Click on the menu to the right of **Warping Restraint for Node i** and set the value to **Free**. Node j is set from the previous step.
- 4) Click on the **Apply** button. 
- 5) Click **Clr** to empty the list of elements. Click on the top element of the middle column.
- 6) Click on the menu to the right of **Warping Restraint for Node i** and set the value to **Continuous**.
Click on the menu to the right of **Warping Restraint for Node j** and set the value to **Free**.
- 7) Click on the **Apply** button. 



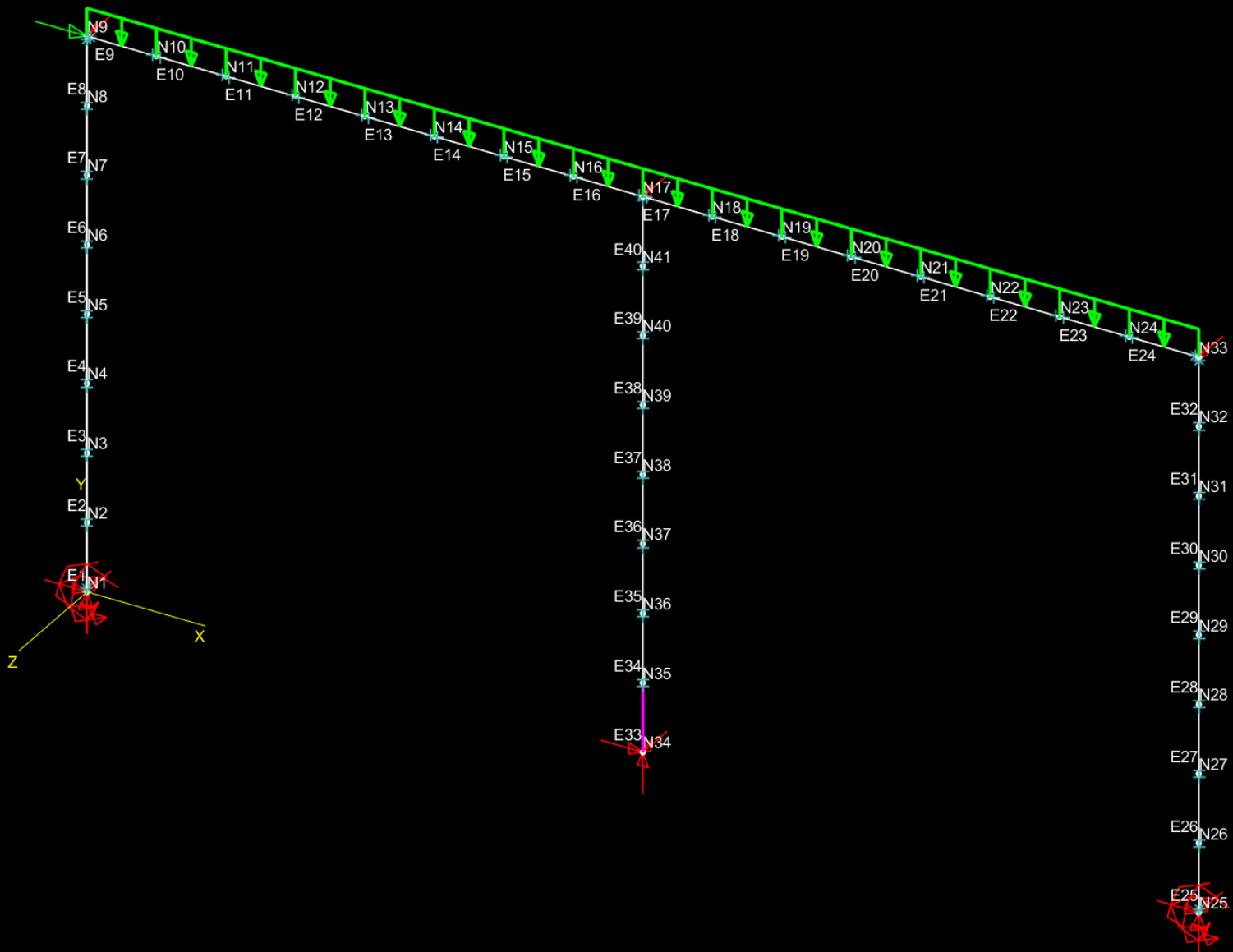

Define element(s) and warping restraint		Element(s):	33	All	Clr	Adv	Status:	Success: Warping Restraint defined.	
Node i	Warping Restraint	Free	Node j	Warping Restraint	Continuous		Apply	Cancel	



MASTAN2



End Moment Release

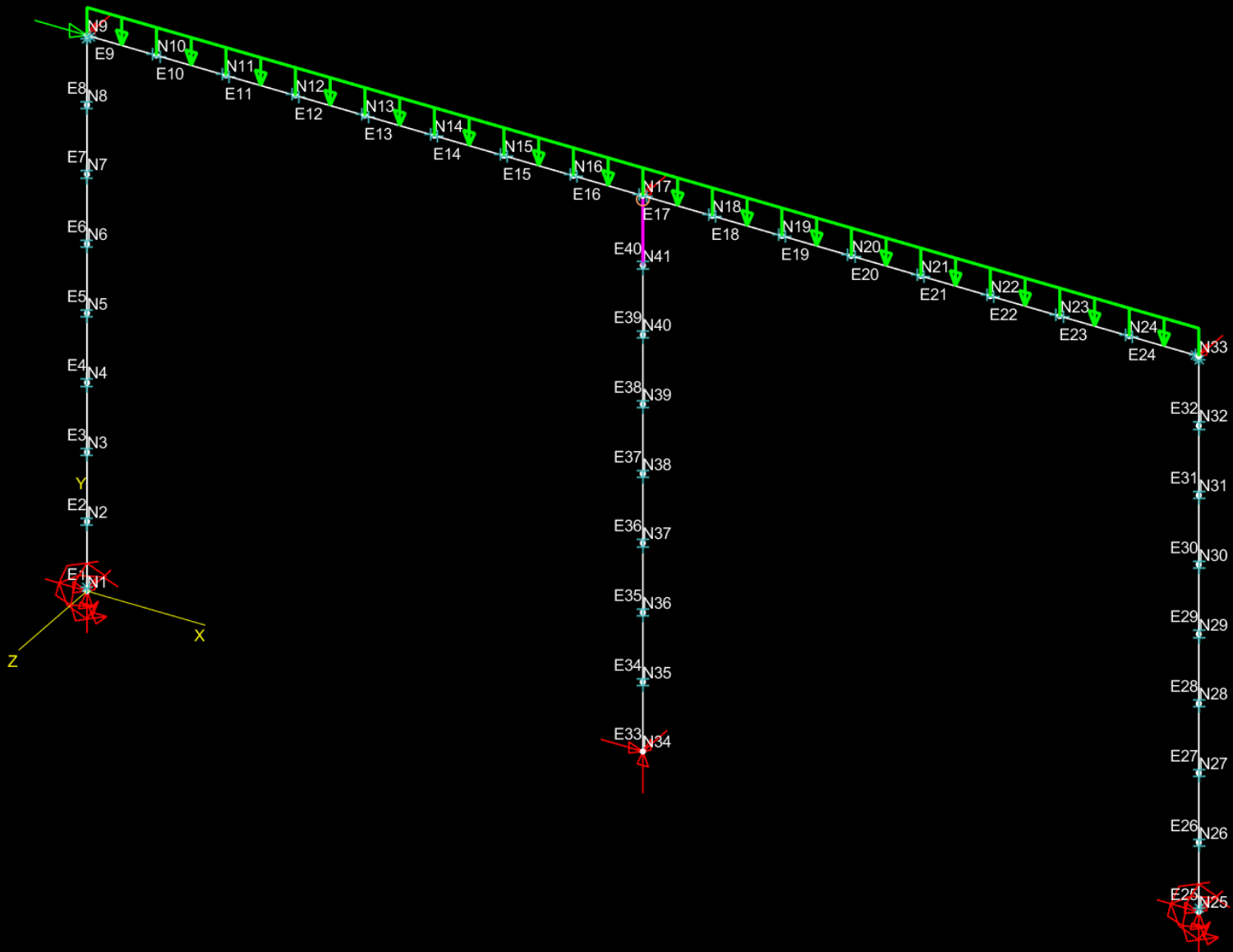

- 1) From the **Geometry** menu select **Define Connections** and submenu option **Flexure**.
- 2) At the bottom menu bar, click on the menu to the right of **Type** for **Node j** and set the value to **Pinned**.
- 3) Create the list of elements by clicking on the top element of the middle column.
- 4) Click on the **Apply** button to apply the pin connection. Note the orange circle is displayed to signify the end that has the M_x and M_y moment released. Torsion cannot be released. 



Define element(s) and connections				Element(s):	40	All	Clr	Adv	Status:	Success: Connection(s) defined.	
Node i	Type	Rigid	kz	inf	ky	inf					
Node j	Type	Pinned	kz	0	ky	0	Apply		Cancel		



Modifying Section Properties

- 1) From the **Properties** menu select **Modify Section**.
- 2) At the bottom menu bar, Section #**1** should be selected already. Click on the pop-up menu on the far right that current displays **Basic**. Click on **Advanced**.
- 3) Click on **MSASect**.
- 4) As the I-beam cross-section is selected by default, click the edit box to the right of **B1=** and enter **10**. Repeat to define **B2=6**, **D=13**, **t1=0.625**, **t2=0.375**, and **t3=0.3125**.
- 5) Click **Calculate** to determine the properties. 
- 6) Click edit box to right of **Name:** and enter **Mono I**
- 7) Click **Export to MASTAN2** to copy values to main program. Then click **Close** to return.
- 8) Click **Apply** to modify Section 1. 



MSASect (Nonsymmetric Section)
_ □ ×

Section Type

Mono-Symmetric I T-Shape Z-Shape
 C-Shape L-Shape Elli-Shape
 Rec-Shape Trap-Shape General

Dimensions

B1=	10	t1=	0.625
B2=	6	t2=	0.375
D=	13	t3=	0.3125

 Database

Section View

(+)
y
B1
t1
z
SC
GC
t3
B2
t2
D
(-)
Z
(-)

Section Properties Name: Phi= 0 Status: Calculated successfully!

Area =	1.241e+01	I z-z =	3.327e+02	I y-y =	5.887e+01	J =	1.046e+00	Cw =	9.337e+02
Ysc =	2.799e+00	Zsc =	0	BetaV =	0	BetaW =	-8.515e+00	Betaw =	0
Z w-w =	5.854e+01	Z v-v =	1.900e+01	A v-v =	4.063e+00	A w-w =	7.083e+00	I y-z =	-2.309e-14



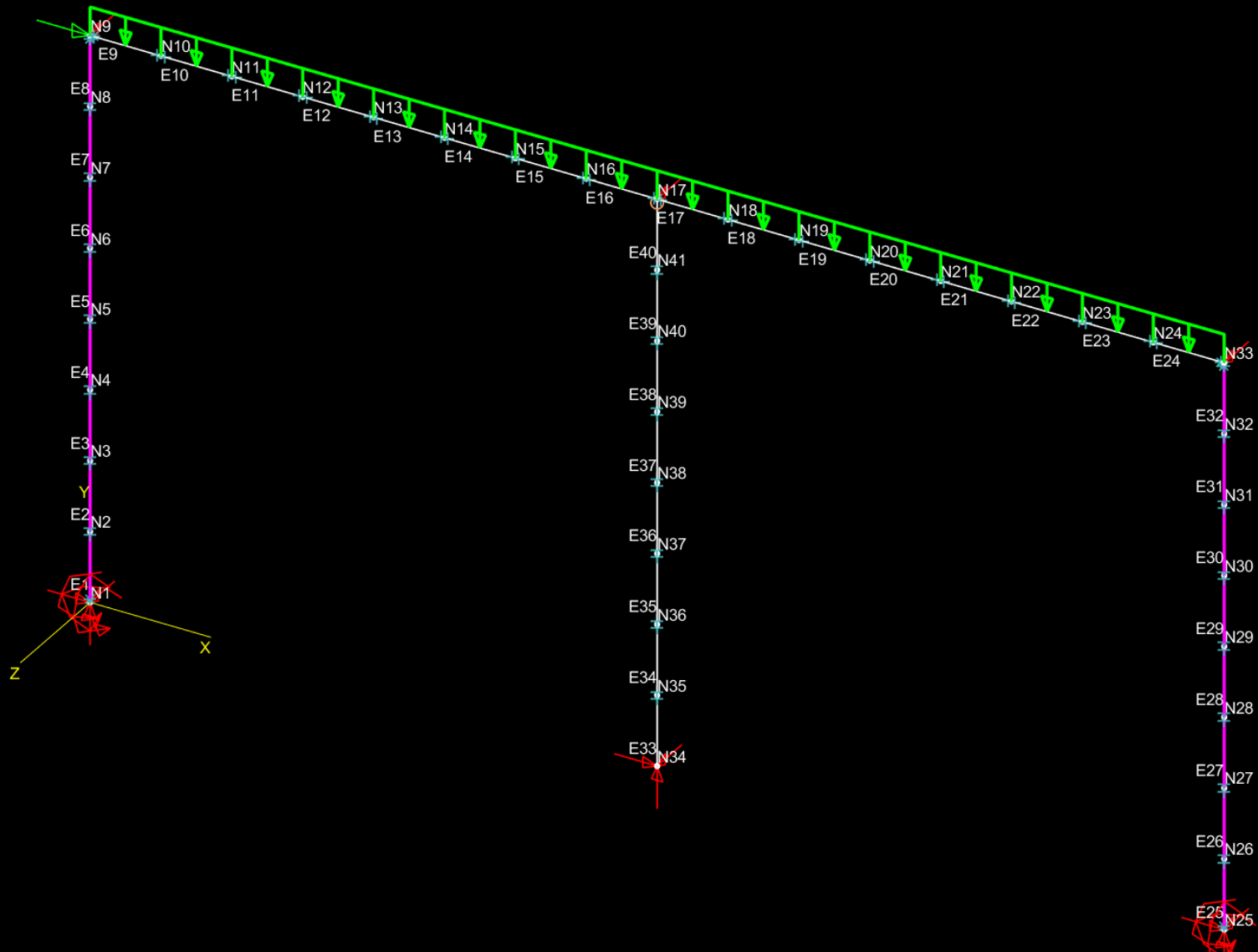



Select Section # and modify properties	1	Name:	Mono I	MSASect	Status:	Success: Section 1 modified.					
Area =	12.4062	I z-z =	332.746	I y-y =	58.8651	J =	1.04643	Cw =	933.682	I y-z =	-2.30926e-14
Ysc =	2.79924	Zsc =	0	BetaV =	0	BetaW =	-8.51467	Betaw =	0	Advanced	
Z w-w =	58.5405	Z v-v =	19	A v-v =	4.0625	A w-w =	7.08333	Apply	Cancel		



Column Orientation

- 1) Since the section was modified, the exterior columns are already assigned the appropriate section. The orientation just needs to be verified.
- 2) From the **Geometry** menu select **Re-orient Element(s)**.
- 3) From the **View** menu select **Labels** and submenu option **Element local x'-y'-z' axes**. Each axis is shown with a different color line drawn in the positive direction. The x axis is purple, the y axis is blue, and the z axis is red. 
- 4) At the bottom menu bar, click in the edit box to the right of **Beta (Deg)** and change **0.0** to **180**.
- 5) Use the buttons to the right of **Element(s):** to make the list of elements. Click the **Adv** button to open the pop-up menu. To select all the right column elements, click the edit box to the left of **X** and change **359** to **400**. Click the edit box to the right of **X** and change **361** to **800**.
- 6) Click **Add** to add all these elements to the element list. Click on the **Apply** button to re-orient the elements. 



MASTAN2

MASTAN2: C:\Users\SSIRL\Desktop\Fram.mat [14:44]

File View Geometry Properties Conditions Analysis Results

Please select element(s) and define new beta angle and/or switch element ends

Switch Element Ends Status:

Element(s):	All	Clr	Adv	<input checked="" type="checkbox"/> Beta (Deg)	0.0	Apply	Cancel
-------------	-----	-----	-----	--	-----	-------	--------



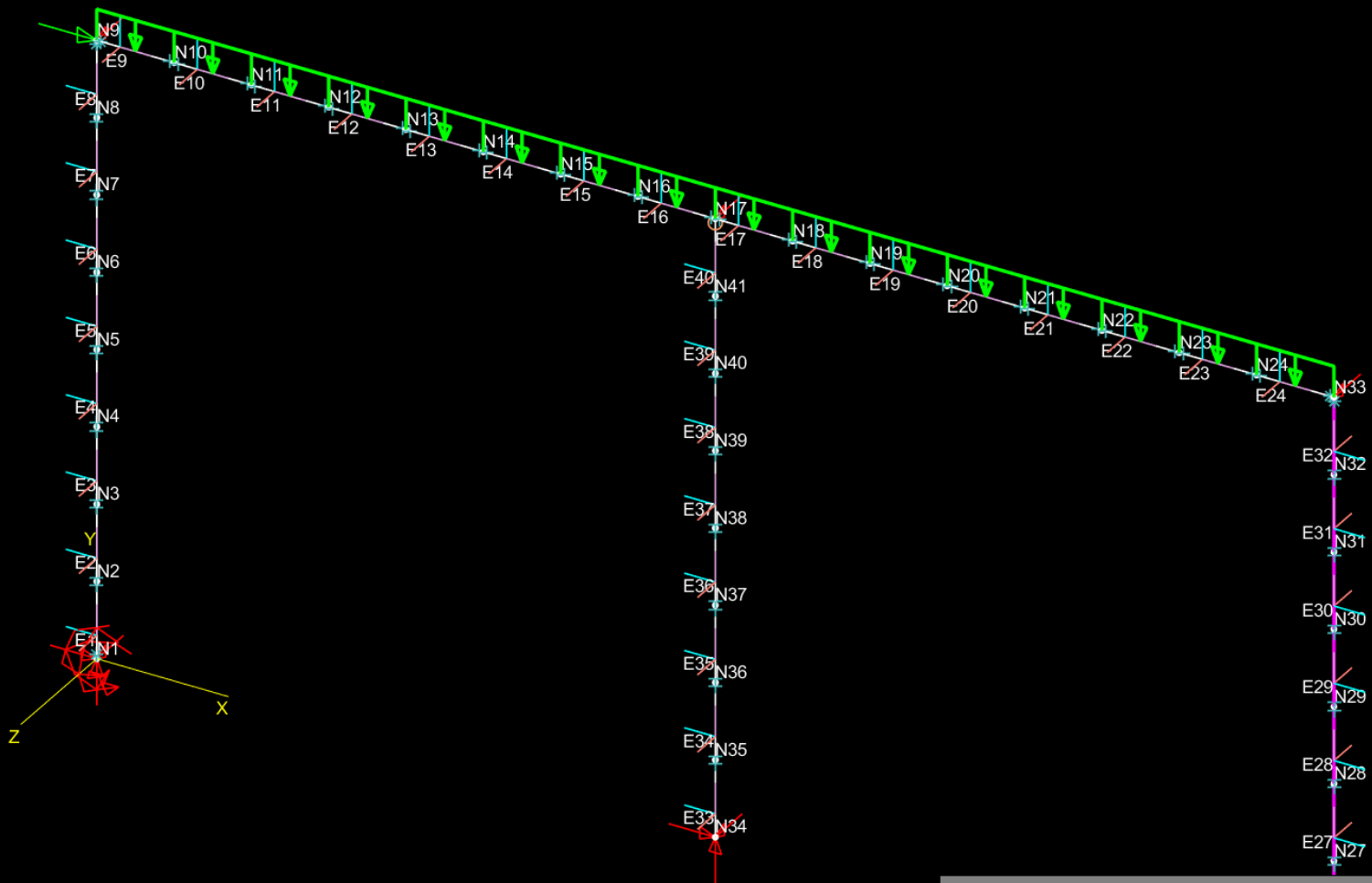

Advanced Element Selection

Parallel to: X-axis Y-axis Z-axis

Range (Inclusive): X: 400 to 800, Y: -Inf to Inf, Z: -Inf to Inf



Add Remove Reset

Please select element(s) and define new beta angle and/or switch element ends Switch Element Ends Status: Success: Element(s) oriented.

Element(s): 25 26 27 28 29 30 31 32 All Cir Adv Beta (Deg) 180 Apply Cancel



3-D Second-Order Elastic Analysis

- 1) From the **Analysis** menu select **Static** and submenu option **2nd-Order Elastic**.
- 2) At the bottom menu bar, the **Analysis Type:** should already be set to **Space Frame** as desired.
- 3) Click on the **Apply** button to perform the analysis. 
- 4) From the **Results** menu select **Node Displacements**.
- 5) On the undeflected shape, click on the node of interest in the upper right corner, **33**, and its components are provided in the bottom menu bar. 

Results:

Disp X	Disp Y	Disp Z	Rot X	Rot Y	Rot Z
2.395	-0.02608	0	~0	~0	-1.304e-4



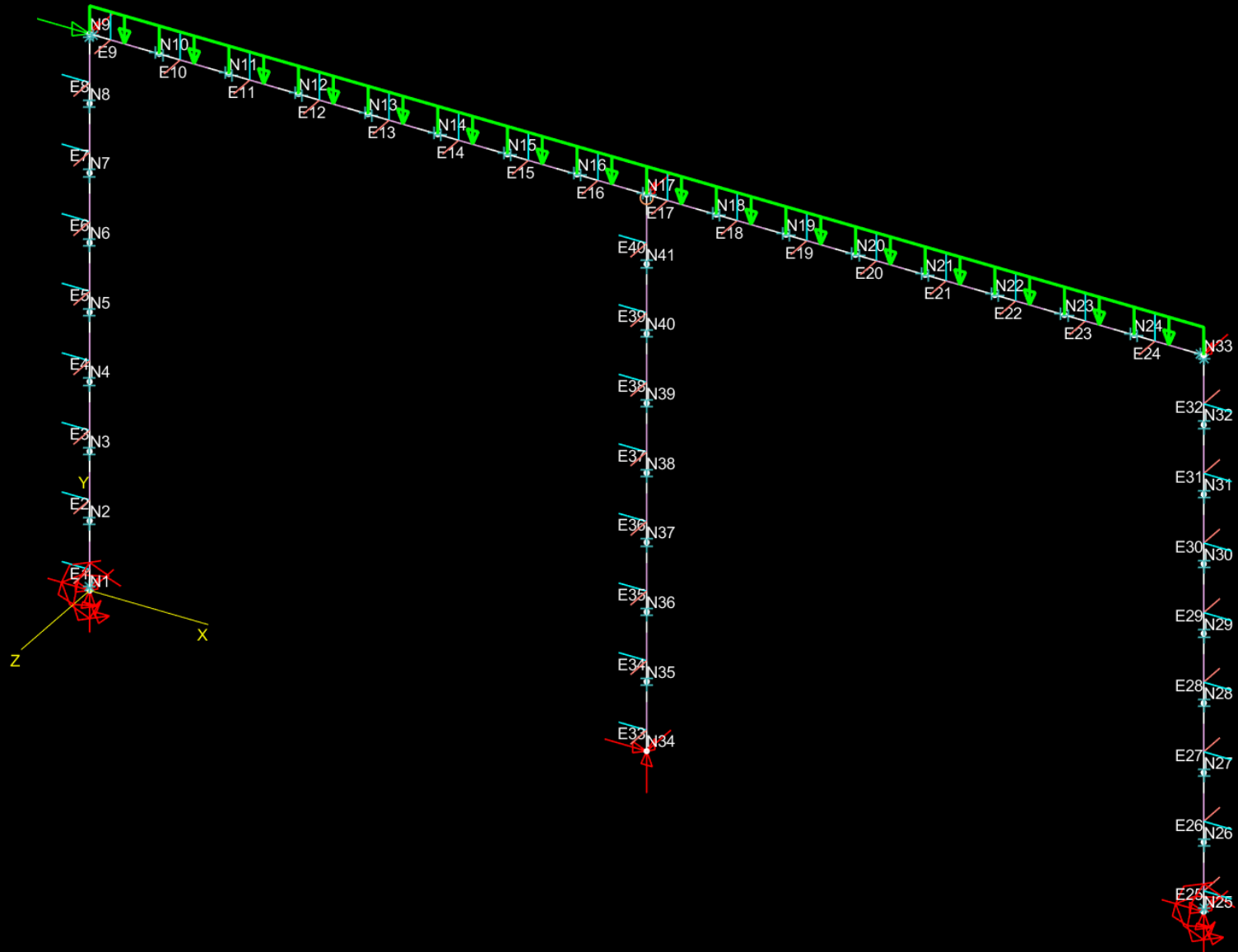

Second-Order Elastic Static Analysis		Status:	Incr # 10, Applied Load Ratio = 1.000 --> Success: Analysis Complete				
Solution Type:	Predictor-Corrector	Incr Size:	0.1	Max. # of Incrs:	10	Max. Appl. Ratio:	1
Analysis Type:	Space Frame	<input type="checkbox"/> [Kff]	Start New	Apply	Cancel		



MASTAN2



Node:	33	Disp X:	2.395	Disp Y:	-0.02608	Disp Z:	0	Status:	Success: Disp. at ALR = 1.0000
Displacements	Rot X:	5.776e-18	Rot Y:	-6.983e-21	Rot Z:	-0.0001304	(10) 1.000	Apply	Cancel









Additional Analysis

This final frame could also have been modeled with MASTAN2 using only the symmetric section properties. Since the frame was loaded only in plane and the non-doubly symmetric effects were not activated, the user would find that it is possible to recreate the frame without the use of advanced section properties and only input the basic section properties and calculate similar displacements.

	Disp X	Disp Y	Rot Z
Basic	2.395	-0.02608	-1.304e-4
Advanced	2.395	-0.02608	-1.304e-4

However, the evaluation of the critical buckling loads of the structure does capture the non-doubly symmetric effects. Different behavior could be observed if the user were to compare such an analysis on the frame with basic and advanced section properties. The first mode and second mode are very similar as the buckling behavior is controlled by the doubly symmetric elements. The third mode displays distinctly different behavior as the column is weaker considering singly symmetric behavior.

	Mode #1	Mode #2	Mode #3
Basic	2.160 	2.806 	4.936 
Advanced	2.160 	2.805 	4.040 



Deflected Shape: Elastic Critical Load, Mode # 1, Applied Load Ratio = 2.1605

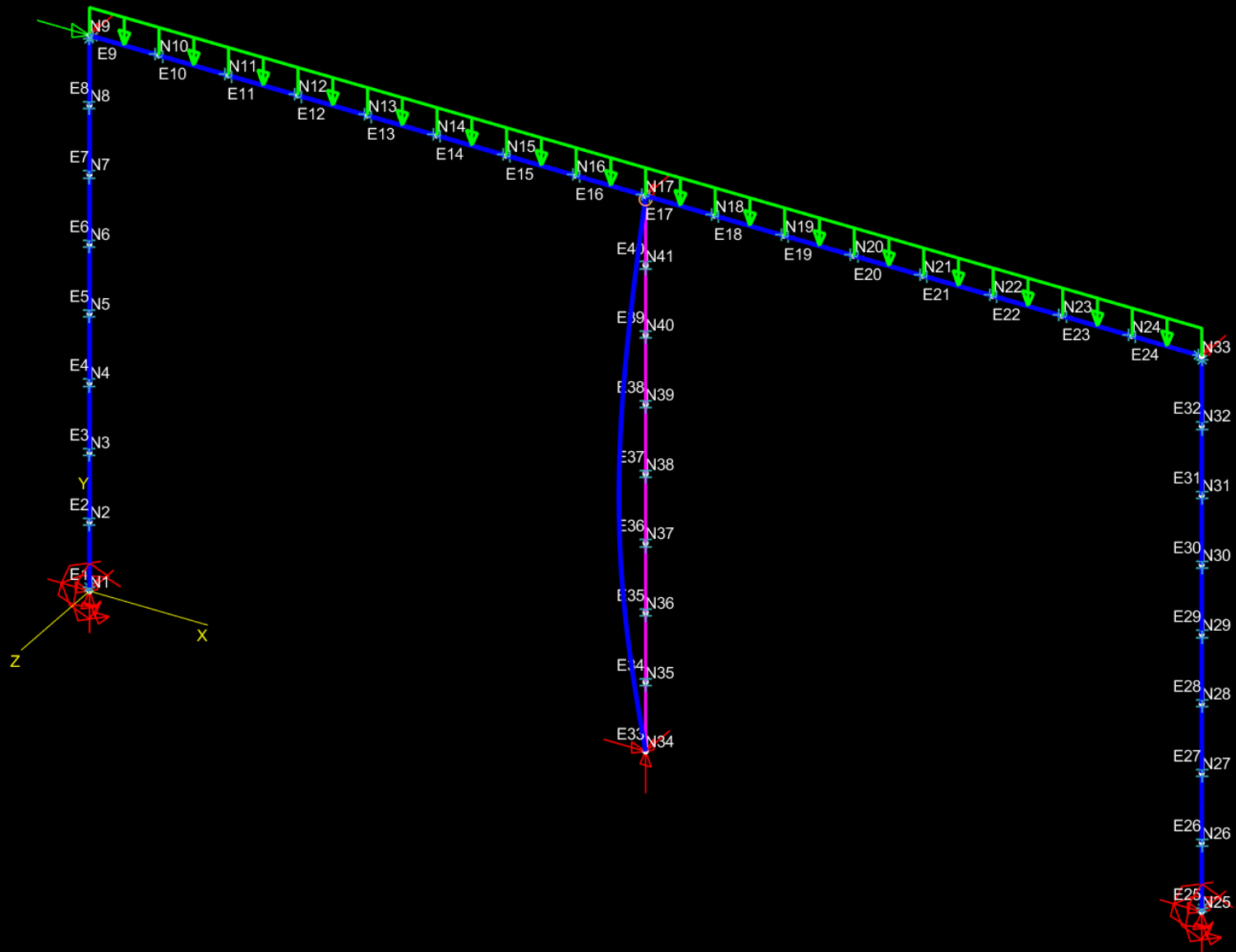

Define element(s) and parameters		Element(s):	All	All	Clr	Adv	Status:	Success: Deflection shown	
Defl Line Type	Solid	Scale	30	# of pts	10	<input type="checkbox"/> Animate	(1) 2.160	Apply	Cancel



Deflected Shape: Elastic Critical Load, Mode # 2, Applied Load Ratio = 2.8058

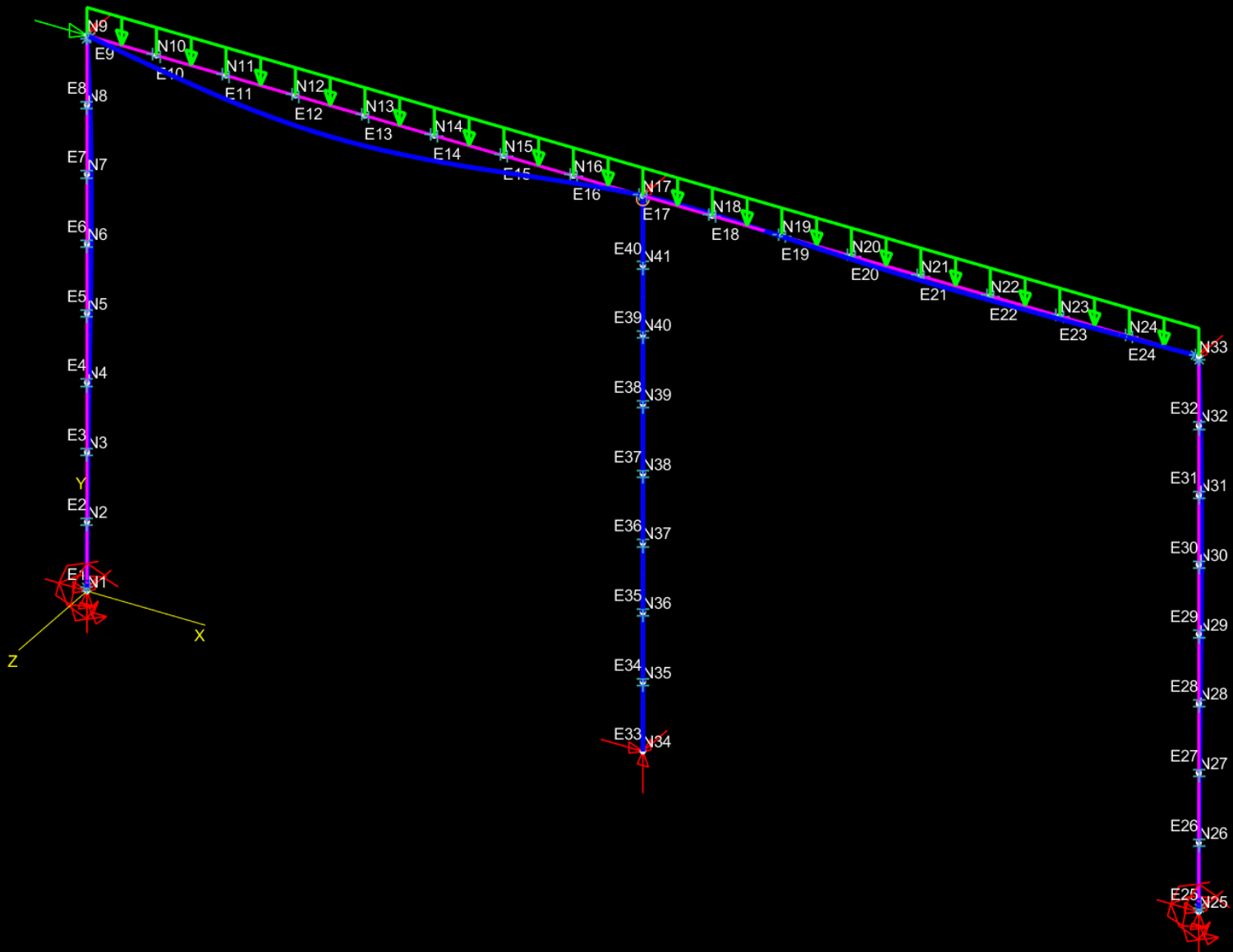

Define element(s) and parameters	Element(s):	All	All	Clr	Adv	Status:	Success: Deflection shown		
Defl Line Type	Solid	Scale	30	# of pts	10	<input type="checkbox"/> Animate	(2) 2.806	Apply	Cancel



Deflected Shape: Elastic Critical Load, Mode # 3, Applied Load Ratio = 4.9364

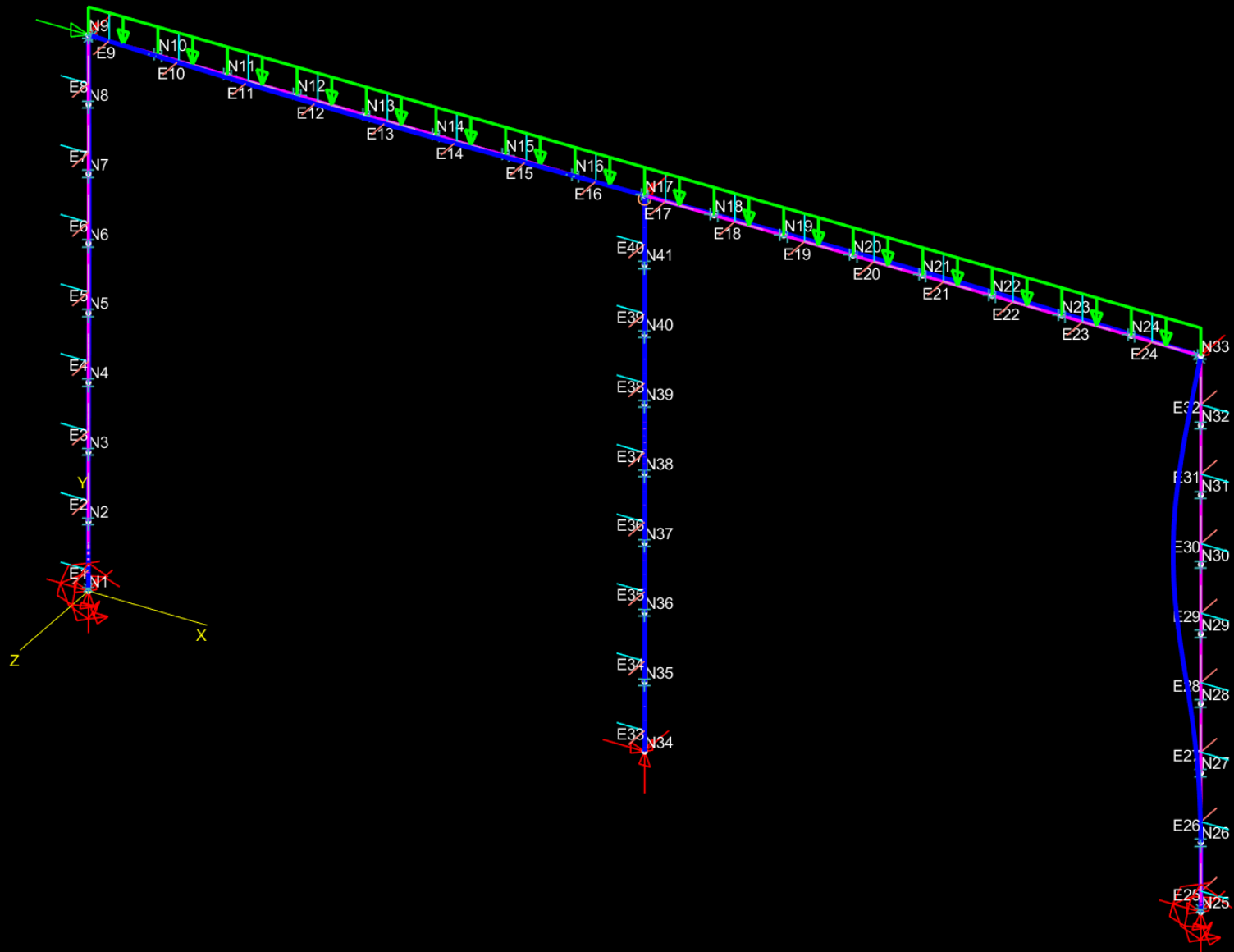

Define element(s) and parameters		Element(s):	All	All	Clr	Adv	Status:	Success: Deflection shown	
Defl Line Type	Solid	Scale	30	# of pts	10	<input type="checkbox"/> Animate	(3) 4.936	Apply	Cancel



Deflected Shape: Elastic Critical Load, Mode # 1, Applied Load Ratio = 2.1605

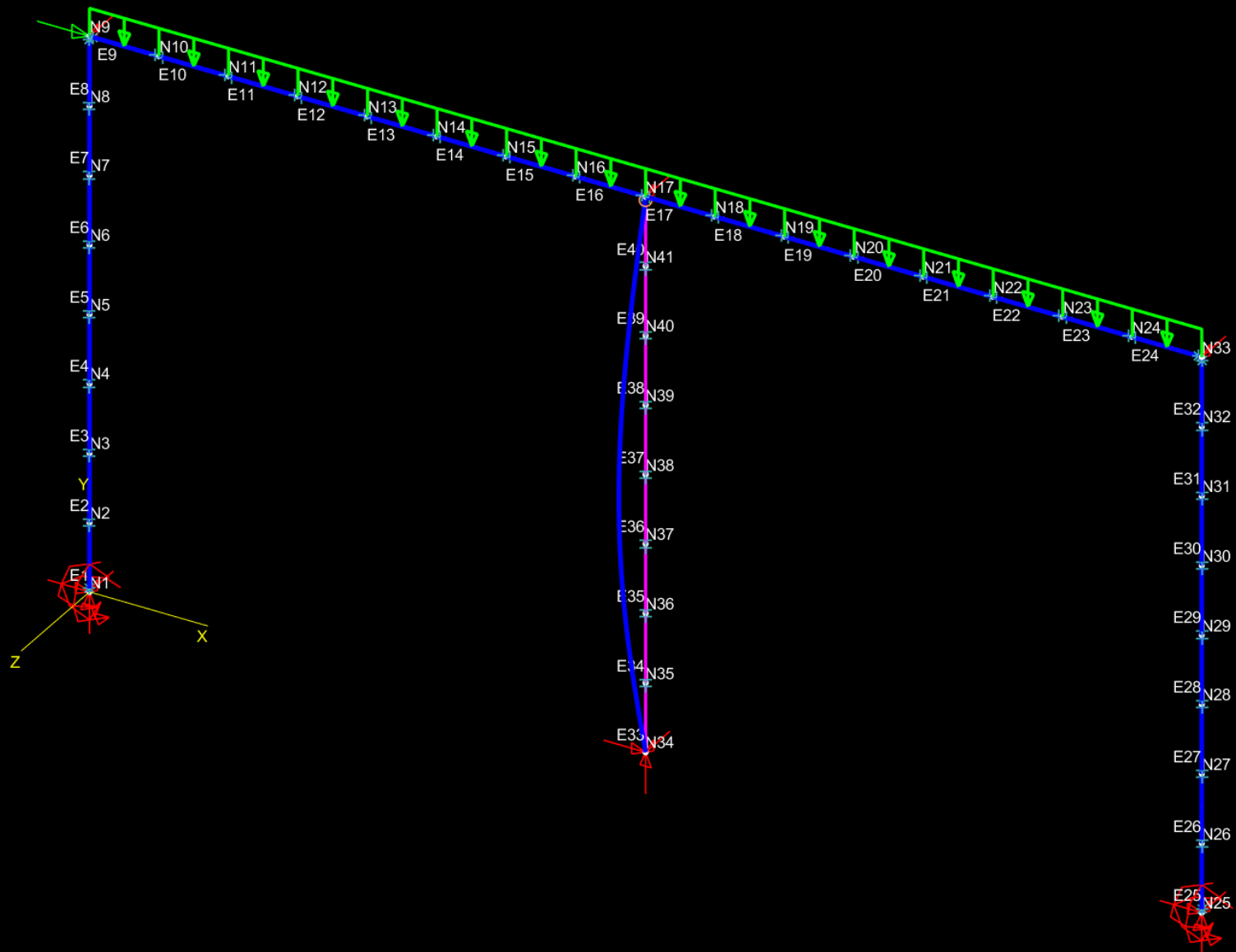

Define element(s) and parameters	Element(s):	All	All	Clr	Adv	Status:	Success: Deflection shown		
Defl Line Type	Solid	Scale	30	# of pts	10	<input type="checkbox"/> Animate	(1) 2.160	Apply	Cancel



Deflected Shape: Elastic Critical Load, Mode # 2, Applied Load Ratio = 2.8052

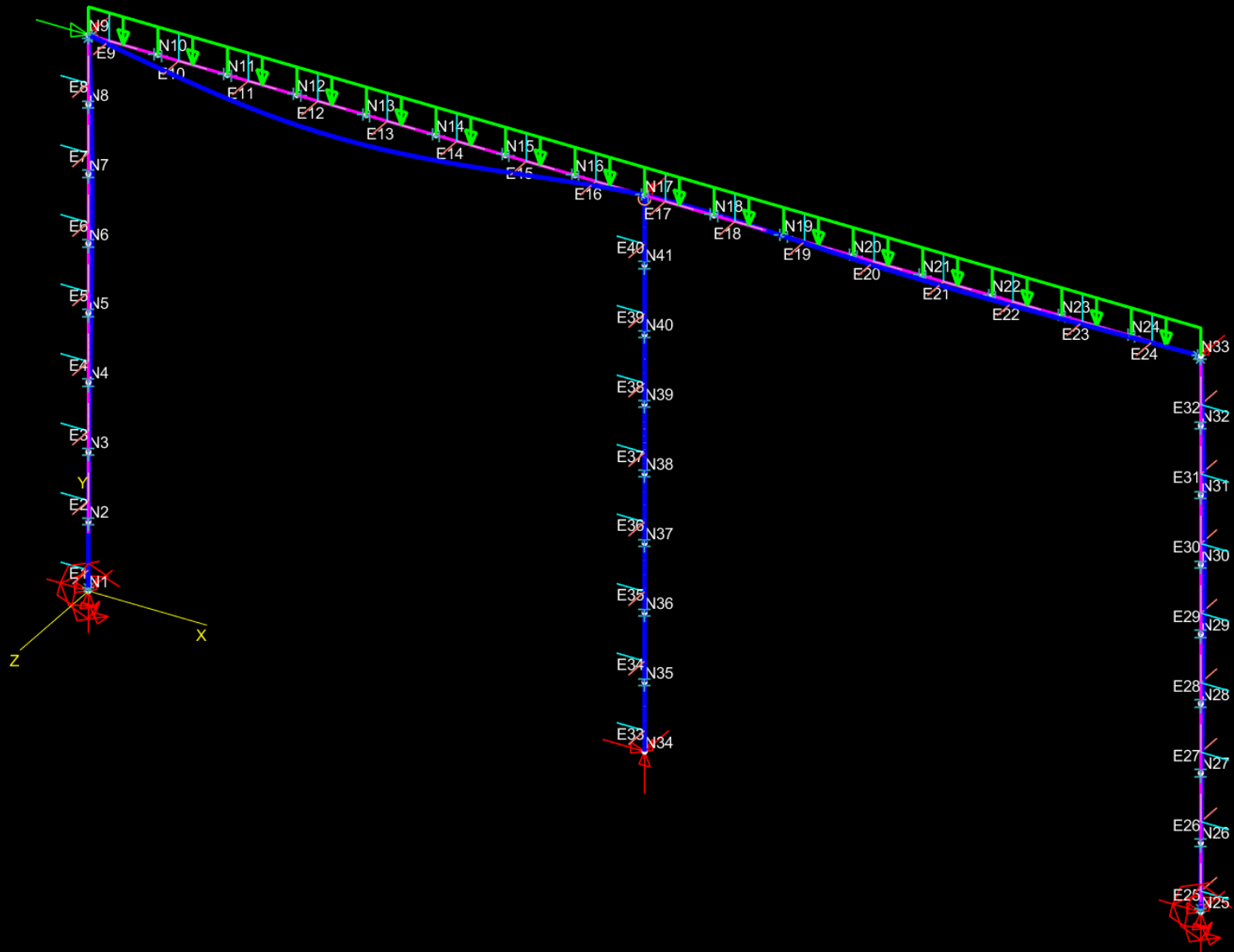

Define element(s) and parameters		Element(s):	All	All	Clr	Adv	Status:	Success: Deflection shown	
Defl Line Type	Solid	Scale	30	# of pts	10	<input type="checkbox"/> Animate	(2) 2.805	Apply	Cancel



Deflected Shape: Elastic Critical Load, Mode # 3, Applied Load Ratio = 4.0396

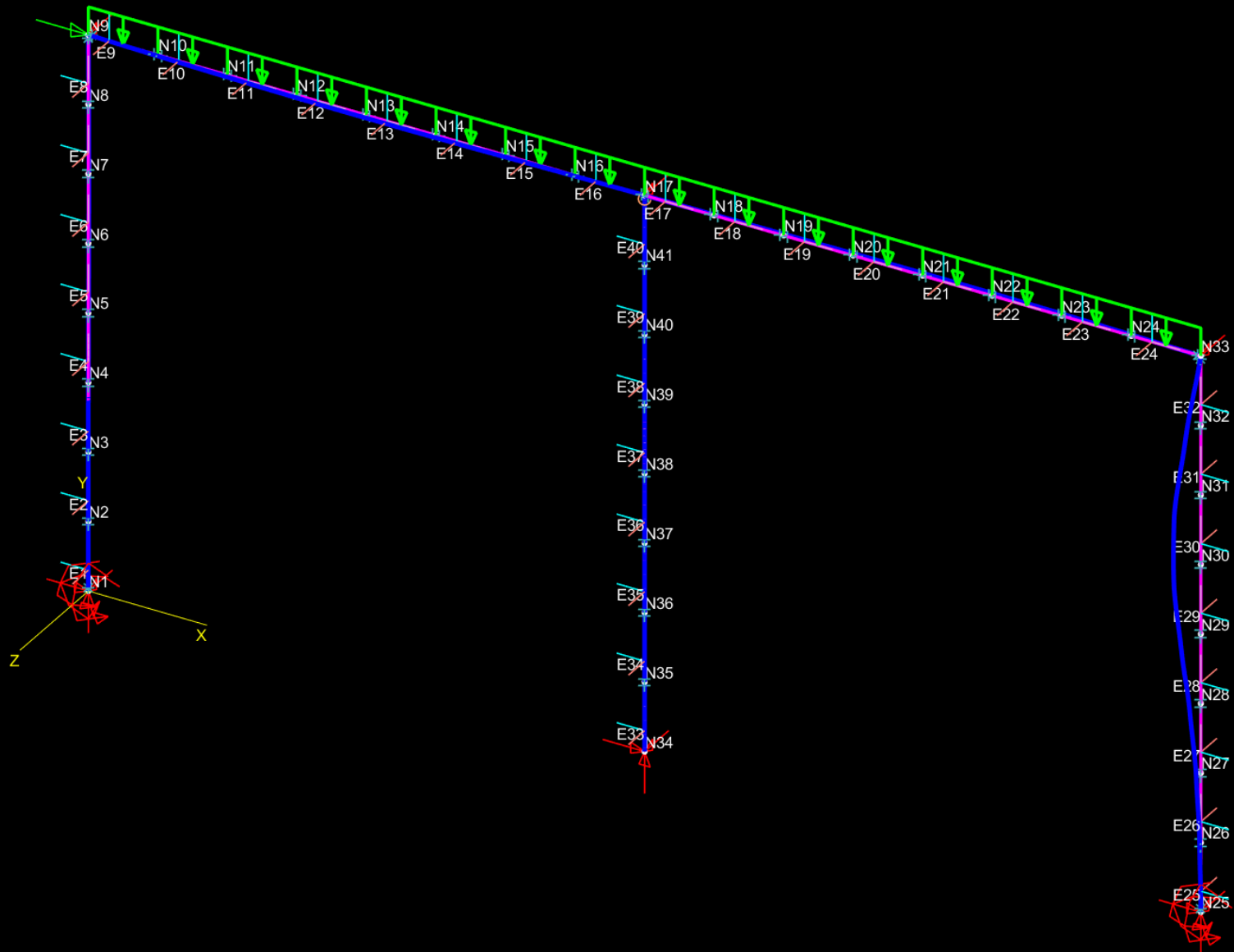

Define element(s) and parameters		Element(s):	All	All	Clr	Adv	Status:	Success: Deflection shown	
Defl Line Type	Solid	Scale	30	# of pts	10	<input type="checkbox"/> Animate	(3) 4.040	Apply	Cancel



This completes the tutorial.

Tutorial for MASTAN2 v5.1 - Pour Stop Beam

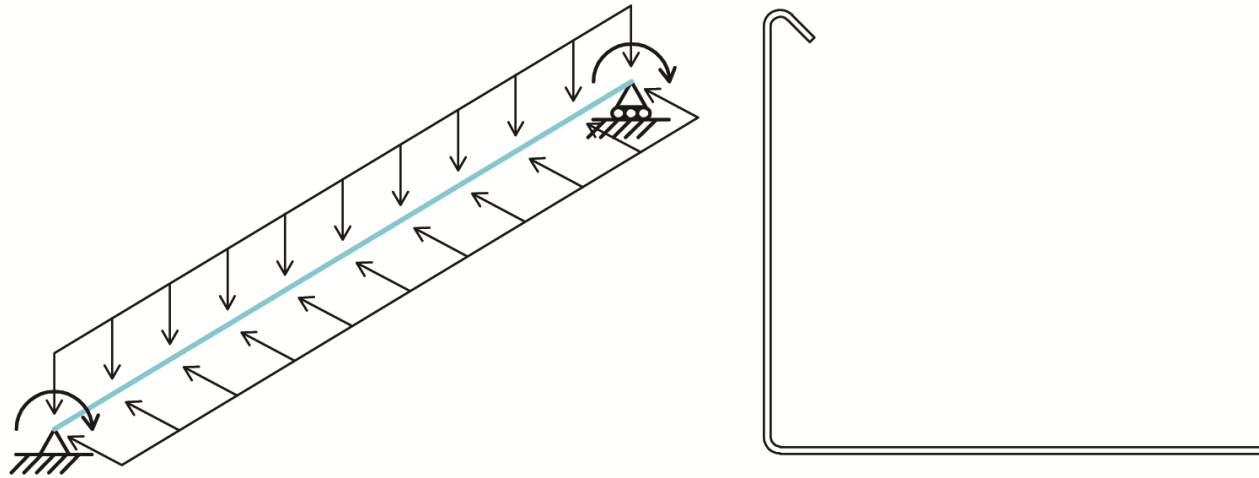

Credits

Published 2020

Developed by:

Edward J. Sippel, Ph.D. Student, University of Wisconsin – Madison

Hannah B. Blum, Assistant Professor, University of Wisconsin - Madison

Ronald D. Ziemian, Professor, Bucknell University

Joe Pote, Director of Research & Development, New Millennium Building Systems

Scott Morton, Research and Development Engineer, New Millennium Building Systems

Sponsored by:

American Iron and Steel Institute

New Millennium Building Systems

Steel Joist Institute

Steel Deck Institute



Tutorial Sections

Section 1: Overview

Section 2: Getting Started

Section 3: Beam Modeling

Section 4: Results and Stress

Section 5: Additional Options

Navigation

 - Skip to Previous Section Title Page

 - Previous Slide

 - Return to Tutorial Sections Page

 - Next Slide

 - Skip to Next Section Title Page

 - Open screenshot of MASTAN2 or additional helpful information.

Section 1: Overview

Overview

This tutorial provides step-by-step guidance for the sample pour stop beam evaluation. Enough details are provided that the example model with non-doubly symmetric sections can be completed following the instructions here. Not every feature available in MASTAN2 will be mentioned nor utilized in this tutorial. For further information on many of the features within MASTAN2 make use of other tutorials at <http://www.mastan2.com/tutorial.html>.



Problem Overview

This tutorial completes the analysis of a simply supported non-doubly symmetric section in MASTAN2 and some of the related stress calculations. The section considered is a pour stop that is simply supported. The values used in this tutorial come from the Steel Deck Institute's Technical Note - No. 3: Pour Stops as Beams.

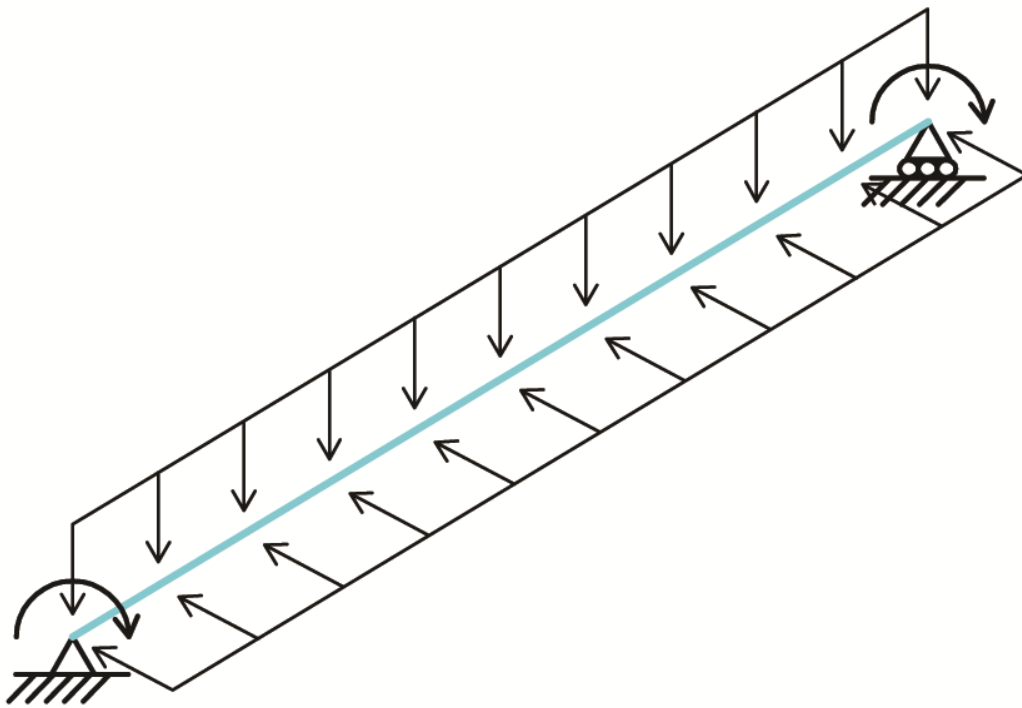

Simple Supported Beam

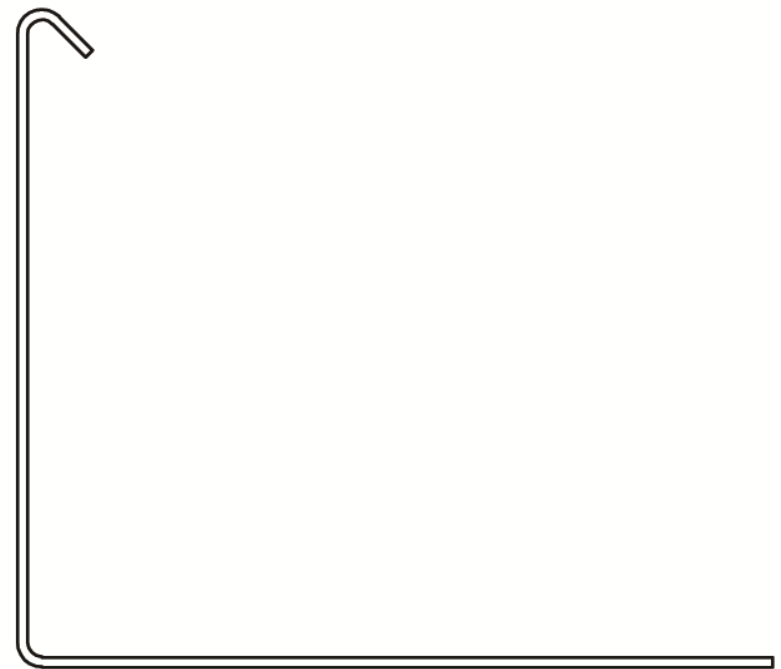

Cross Section



Section 2: Getting Started

MASTAN2 General Information

MASTAN2 is an interactive graphics program that provides preprocessing, analysis, and postprocessing capabilities. Preprocessing options include definition of structural geometry, support conditions, applied loads, and element properties. The analysis routines provide the user the opportunity to perform first- or second-order elastic or inelastic analyses of two- or three-dimensional frames and trusses subjected to static and dynamic loads. Postprocessing capabilities include the interpretation of structural behavior through deformation and force diagrams, printed output, and facilities for plotting response curves. MASTAN2 is based on MATLAB®, a premier software package for numeric computing and data analysis.

In many ways, MASTAN2 is similar to today's commercially available software in functionality. The number of pre- and post-processing options, however, have been limited in order to minimize the amount of time needed for a user to become proficient at its use. The program's linear and nonlinear analysis routines are based on the theoretical and numerical formulations presented in the text *Matrix Structural Analysis, 2nd Edition*, by McGuire, Gallagher, and Ziemian. In this regard, the reader is strongly encouraged to use this software as a tool for demonstration, reviewing examples, solving problems, and perhaps performing analysis and design studies. Where MASTAN2 has been written in modular format, the reader is also provided the opportunity to develop and implement additional or alternative analysis routines directly within the program.

MATLAB is a registered trademark of The MathWorks, Inc., 3 Apple Hill Drive, Natick, MA 01760-2098.



Launching MASTAN2

Two versions of MASTAN2 have been developed and may be installed. One requires you to have access to MATLAB and the other does not. Both versions provide the same functionality, except that the MATLAB version also provides the user an opportunity to develop and implement additional or alternative analysis routines that will directly interact with MASTAN2. Please see the Setup Guides at www.mastan2.com.

MASTAN2 v3.5

Home
About
FAQ's
Screenshots
Tutorial
Stability Fun
Textbook
Download
Contact

Designed By
Projectdesigns.org
XHTML 1.0 Strict

Overview
MASTAN2 is an interactive structural analysis program that provides preprocessing, analysis, and postprocessing capabilities.

- Preprocessing
- Analysis
- Postprocessing

Preprocessing
Preprocessing options include definition of structural geometry, support conditions, applied loads, and element properties.

Analysis
The analysis routines provide the user the opportunity to perform first- or second-order elastic or inelastic analyses of two- or three-dimensional frames and trusses subjected to static loads.

Postprocessing
Postprocessing capabilities include the interpretation of structural behavior through deformation and force diagrams, printed output, and facilities for plotting response curves.

Start Here



Base Layout

In order to minimize the learning time for MASTAN2, its graphical user interface (GUI) has been designed using a simple and consistent two menu approach. Using a pull-down menu at the top of the GUI, a command is selected. Parameters are then defined in the bottom menu bar and the command is executed by using the Apply button.

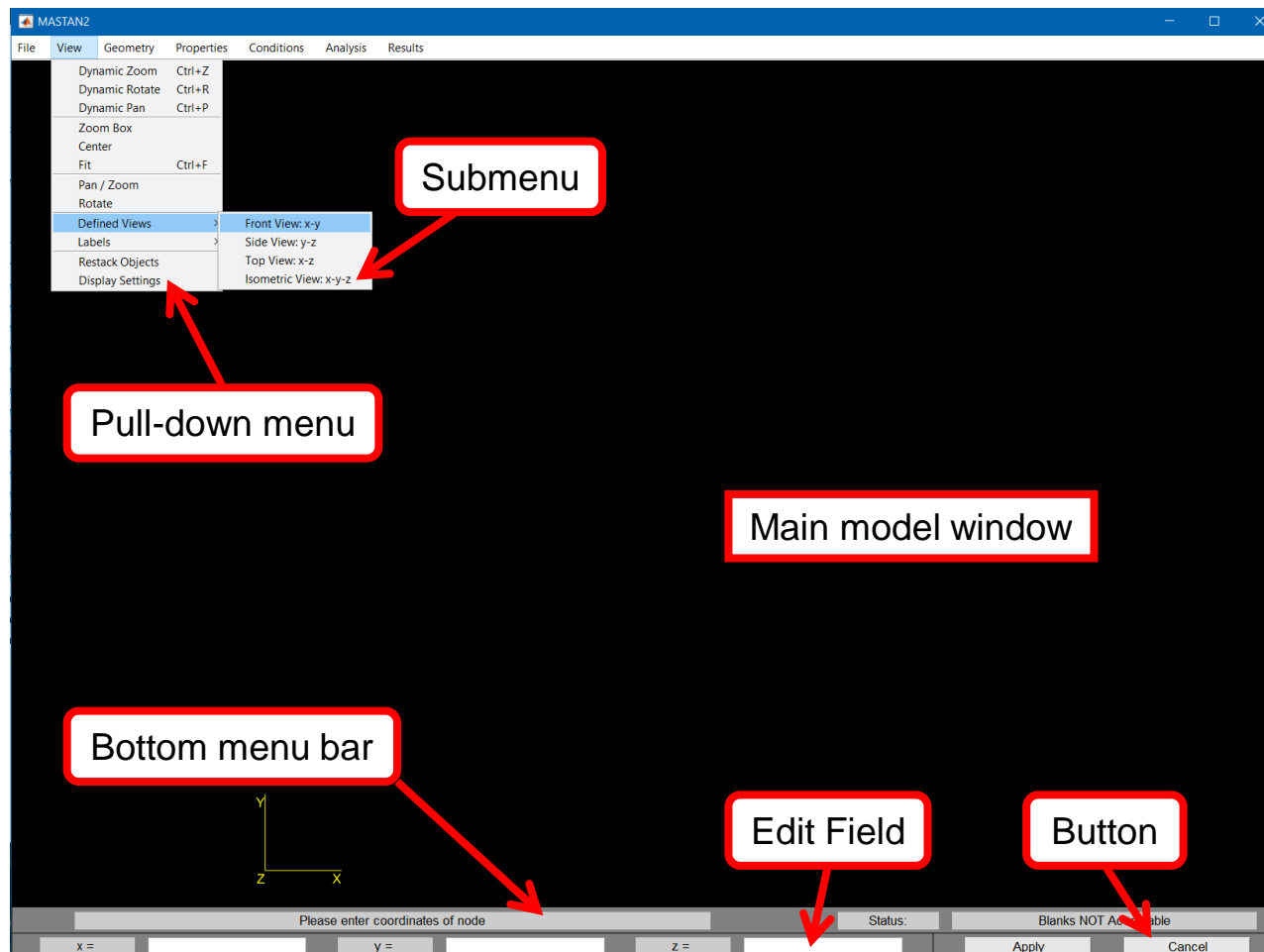

Section 3: Beam Modeling

Problem Description - Figure

The pour stop is a cold-form steel cross-section. The section is subjected to a uniform lateral and uniform vertical load as well as a distributed torsion. The model itself will be a simply supported beam with the ends fixed for torsion, but free to warp. Details on the applied load are on the next page.

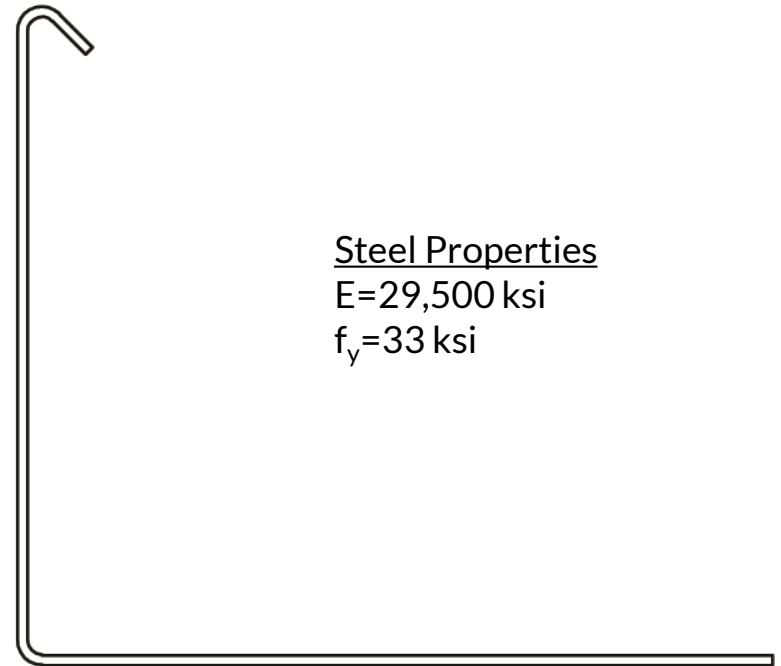
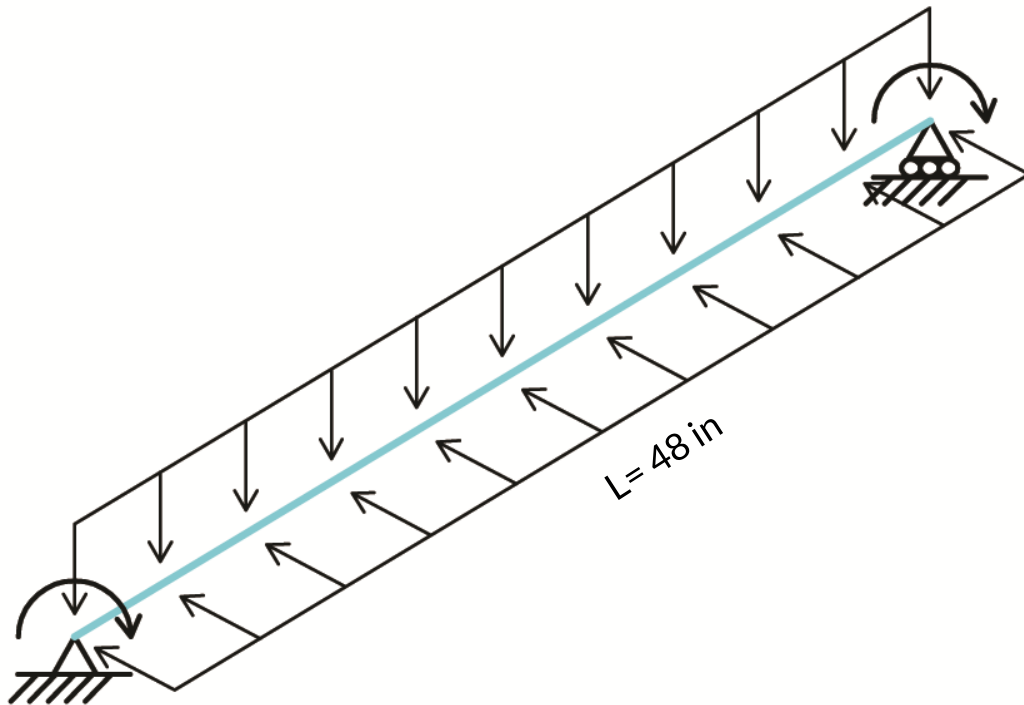

Steel Properties

$E = 29,500$ ksi

$f_y = 33$ ksi

MASTAN2 does not assume any unit system. Models in MASTAN2 require the use of a consistent set of units. This tutorial will use pound and inch for the model. The later section of the tutorial that determines the internal stresses does include a unit conversion to show stresses in ksi.



Problem Description - Loading

The pour stop is subjected to a uniform surcharge load, a pressure from the wet concrete, self-weight, and a linear load from similar sources due to interactions with the deck. Uniform distributed loads are available in MASTAN2; however, distributed torsional moments are not possible. To obtain a similar effect the loading will be applied via concentrated point loads and concentrated moments with many smaller elements along the length of the member

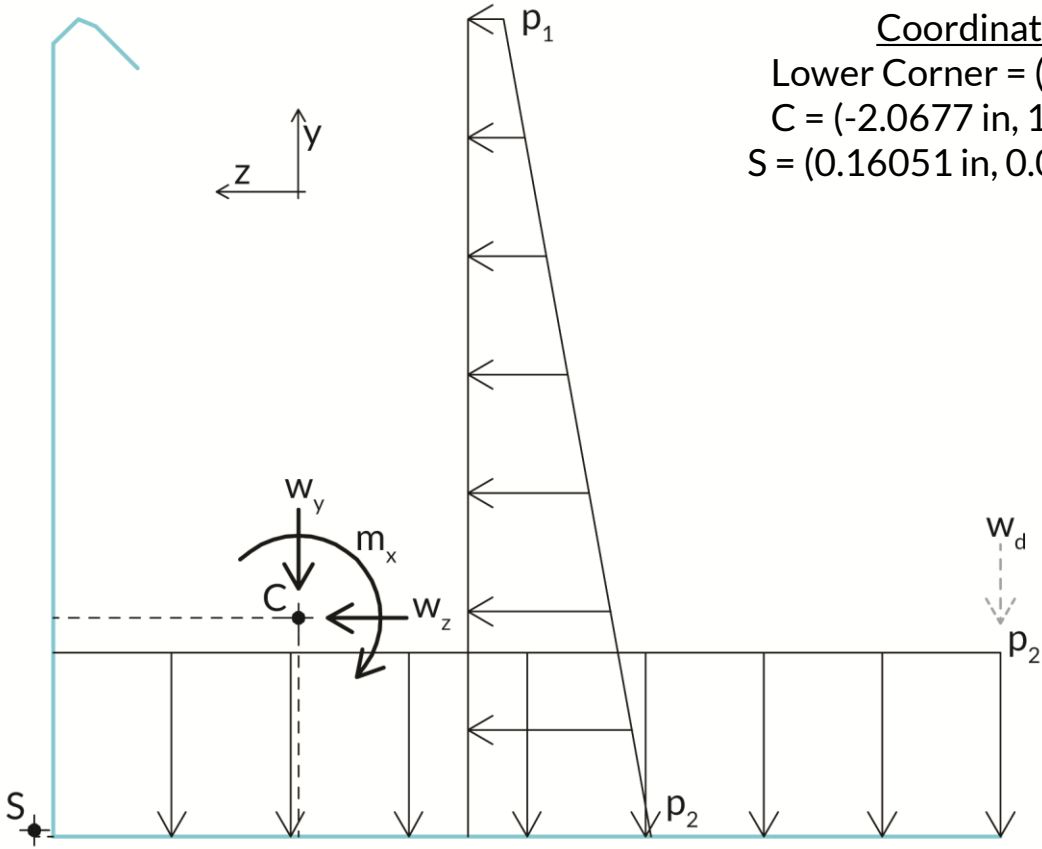

Coordinates
 Lower Corner = (0 in, 0 in)
 C = (-2.0677 in, 1.8405 in)
 S = (0.16051 in, 0.052335 in)

Load Details
 See SDI Tech No. 3 for additional information

$p_1 = 20 \text{ psf}$
 $p_2 = 103.3 \text{ psf}$
 $w_d = 0 \text{ plf } \downarrow$

Resulting Loads
 $w_y = 74.0 \text{ plf } \downarrow$
 $= 6.17 \text{ pli } \downarrow$

$w_z = 35.4 \text{ plf } \leftarrow$
 $= 2.95 \text{ pli } \leftarrow$

$m_x = 104.5 \text{ in-lb/ft } \curvearrowright$
 $= 8.71 \text{ in-lb/in } \curvearrowright$





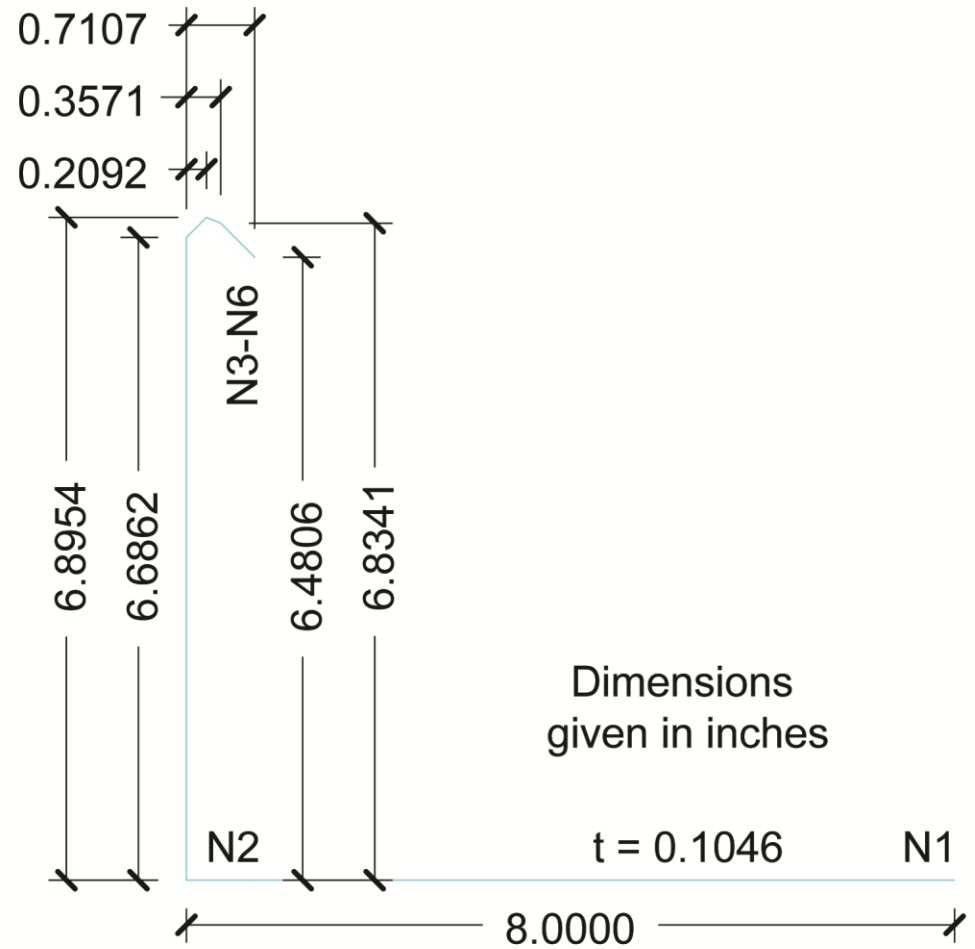

Problem Description - Cross Section

The real pour stop has the rounded geometry shown on the left. The rounded segments, particularly at the top, could be defined by many closely spaced nodes to account for the full radius. However, this tutorial will use the simplified geometry shown on the right based on SDI Tech No. 3.



Geometry Definition

- 1) Start with a new, empty model. 
- 2) From the **Geometry** menu select **Define Node**.
- 3) At the bottom menu bar, click in the edit box to the right of **x =** and enter **0**. Click in the edit box to the right of **y =** and enter **0**. Click in the edit box to the right of **z =** and enter **0**.
- 4) Click on the **Apply** Button. 
- 5) From the **Geometry** menu select **Extrude Element**.
- 6) At the bottom menu bar, click on Node **1** to populate the list of nodes. Click in the edit box to the right of **Delta x =** and change **0** to **2**.
- 7) Repeatedly click the **>** button to the right of **Times =** to increase **1** to **24**.
- 8) Click on the **Apply** Button. 

Clicking the  icon will advance the tutorial to a page that provides an image of the MASTAN2 interface after the corresponding step is executed. Clicking the  icon on that page will return you to the step-by-step instructions.



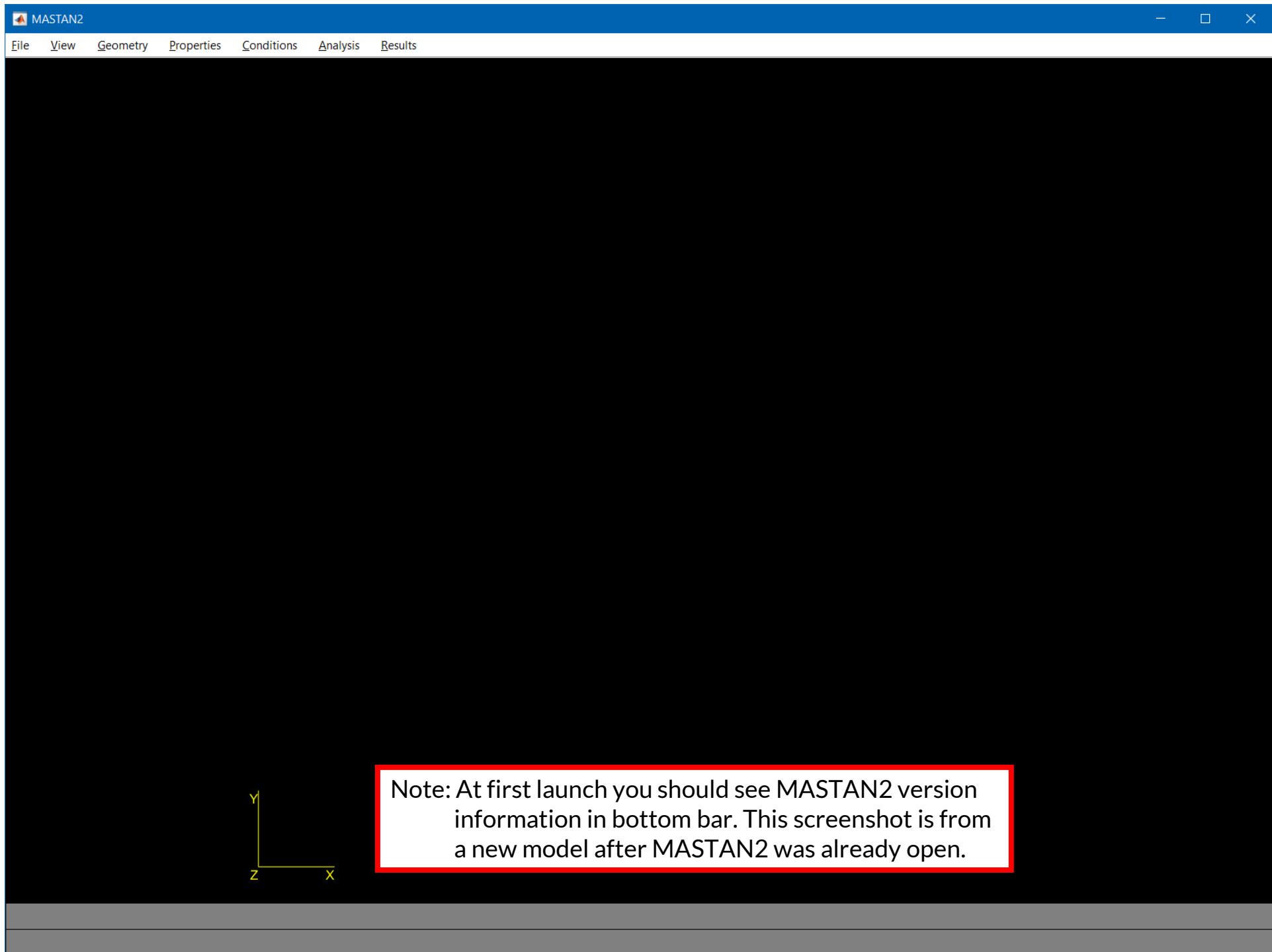

MASTAN2

File View Geometry Properties Conditions Analysis Results



Please enter coordinates of node

Status: Success: Node 1 defined.

x = 0 y = 0 z = 0

Apply Cancel



MASTAN2

File View Geometry Properties Conditions Analysis Results



N1 N2 N3 N4 N5 N6 N7 N8 N9 N10 N11 N12 N13 N14 N15 N16 N17 N18 N19 N20 N21 N22 N23 N24 N25
E1 E2 E3 E4 E5 E6 E7 E8 E9 E10 E11 E12 E13 E14 E15 E16 E17 E18 E19 E20 E21 E22 E23 E24

Define node(s) and data to extrude element(s) Node(s): All Clr Adv Status: Success: Element(s) Extruded.

Delta x = 0 Delta y = 0 Delta z = 0 Beta (deg) 0 Times = < 1 > Apply Cancel



Cross Section Visualization

- 1) From the **View** menu select **Defined Views** and submenu option **Isometric: x-y-z**.
- 2) Now with the main member defined, continue to use **Extrude Element** to illustrate cross section.
- 3) At the bottom menu bar, click on node **13** to populate the list of nodes. Click in the edit box to the right of **Delta y =** and change **0** to **-1.8405**. Click in the edit box to the right of **Delta z =** and change **0** to **2.0677**.
- 4) Click on the **Apply** Button to define an element connecting the centroid to the lower corner of the pour stop cross section which was labeled N2 in the previous cross-section definition. 
- 5) At the bottom menu bar, click on **Node 26** to populate the list of nodes. Click in the edit box to the right of **Delta z =** and change **0** to **-8**. Click on the **Apply** Button. 

Note: If there was another position along the bottom flat where the deflection was of interest, 2 elements could be extruded by altering the process to extrude twice in the z direction with the appropriate **Delta z** values or by subdividing the bottom element and then moving the new node to the appropriate location.



MASTAN2

File View Geometry Properties Conditions Analysis Results

Define node(s) and data to extrude element(s) Node(s): All Clr Adv Status: Success: Element(s) Extruded.

Delta x = 0 Delta y = 0 Delta z = 0 Beta (deg) 0 Times = < 1 > Apply Cancel



MASTAN2

File View Geometry Properties Conditions Analysis Results

Define node(s) and data to extrude element(s) Node(s): All Clr Adv Status: Success: Element(s) Extruded.

Delta x = 0 Delta y = 0 Delta z = 0 Beta (deg) 0 Times = < 1 > Apply Cancel



Cross Section Visualization Finish

- 1) Continue defining the cross section by clicking on **Node 26** to populate the list of nodes. Click in the edit box to the right of **Delta y =** and change **0** to **6.6862**. Click on the **Apply** Button.
- 2) Click on **Node 28** to populate the list of nodes. Click in the edit box to the right of **Delta y =** and change **0** to **0.2092**. Click in the edit box to the right of **Delta z =** and change **0** to **-0.2092**. Click on the **Apply** Button.
- 3) Click on **Node 29** to populate the list of nodes. Click in the edit box to the right of **Delta y =** and change **0** to **-0.0613**. Click in the edit box to the right of **Delta z =** and change **0** to **-0.1479**. Click on the **Apply** Button.
- 4) Click on **Node 30** to populate the list of nodes. Click in the edit box to the right of **Delta y =** and change **0** to **-0.3535**. Click in the edit box to the right of **Delta z =** and change **0** to **-0.3535**. Click on the **Apply** Button. 

Note: For the area where nodes are close together, from the **View** menu select **Zoom Box** to be able to zoom in and easier identify which node you are clicking.



MASTAN2





File View Geometry Properties Conditions Analysis Results

Define node(s) and data to extrude element(s) Node(s): All Clr Adv Status: Success: Element(s) Extruded.

Delta x = 0 Delta y = 0 Delta z = 0 Beta (deg) 0 Times = < 1 > Apply Cancel



Creating Section Properties

- 1) From the **Properties** menu select **Define Section**.
- 2) At the bottom menu bar, click on the pop-up menu on the far right that currently displays **Basic**.
Click on **Advanced**. 
- 3) Click on **MSASect**.
- 4) After the interface loads, click on **General** to select the radio button next to it. 
- 5) Click **Next** to open the editable dialog boxes.
- 6) Click the edit box to the right of **ID:** and enter **1**. Click the edit box to the right of **Z-Coor.=** and enter **-8**. Click the edit box to the right of **Y-Coor.=** and enter **0**. Click **Add** to save the node. 
- 7) Repeat entering the values below for each node clicking **Add** after each one. 

ID:	2	3	4	5	6
Z-Coor.=	0	0	-0.2092	-0.3571	-0.7107
Y-Coor.=	0	6.6862	6.8954	6.8341	6.4806

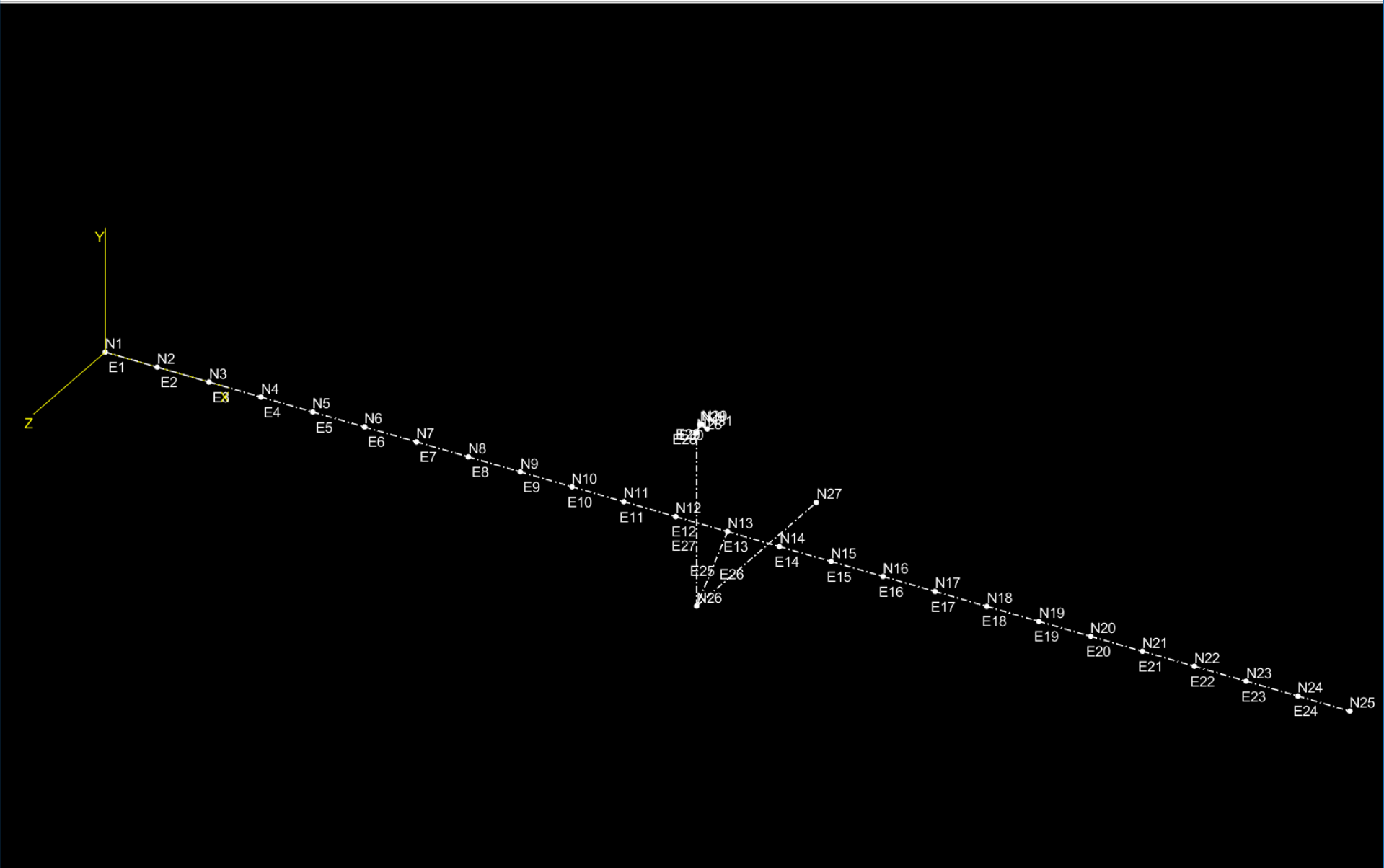

Please enter section properties		Section 1	Name:	MSASect	Status:
Area =	0	I z-z =	0	I y-y =	0
J =	0	Cw =	0	I y-z =	0
Ysc =	0	Zsc =	0	BetaV =	0
BetaW =	0	Betaw =	0	Advanced	▼
Z w-w =	inf	Z v-v =	inf	A v-v =	inf
A w-w =	inf			Apply	Cancel



MSASect (Nonsymmetric Section)

Section Type

Mono-Symmetric I T-Shape Z-Shape

C-Shape L-Shape Elli-Shape

Rec-Shape Trap-Shape General

Dimensions

Please click the Next button to proceed.

Next

Section View

(+) <----- Z ----- (-)

(-) ----- Y ----- (+)

Section Properties

Name: Phi= Status:

Area = I z-z = I y-y = J = Cw =

Ysc = Zsc = BetaV = BetaW = Betaw =

Z w-w = Z v-v = A v-v = A w-w = I y-z =

Reset Export to Mastan2 Close



MSASect (Nonsymmetric Section)

-Nodes-

1	ID:	1	Add
	Z-Coord.	-8	Modify
	Y-Coord.	0	Delete

-Segments-

	ID:		Add
	Start Node=		Modify
	End Node=		Delete
	Thickness=		

Section View

(+) <----- Z ----- (-)
(-) ----- Y -----> (+)

Calculate

Section Properties Name: Phi= Status:

Area = I z-z = I y-y = J = Cw =

Ysc = Zsc = BetaV = BetaW = Betaw =

Z w-w = Z v-v = I y-z =

Reset Open Save Save As Export to Mastan2 Cancel



MSASect (Nonsymmetric Section)

Nodes

2	ID:	6	Add
3	Z-Coor. =	-0.7107	Modify
4	Y-Coor. =	6.4806	Delete
5			
6			

Segments

	ID:		Add
	Start Node =		Modify
	End Node =		Delete
	Thickness =		

Section View

Diagram showing nodes 1, 2, 3, 4, 5, 6. Node 1 is at the bottom right, node 2 at the bottom left, and nodes 3, 4, 5, 6 are clustered at the top. Coordinate axes Z (horizontal) and Y (vertical) are shown with (+) and (-) directions.





Calculate

Section Properties	Name:	Phi =	Status:	
Area =	I z-z =	I y-y =	J =	Cw =
Ysc =	Zsc =	BetaV =	BetaW =	Betaw =
Z w-w =	Z v-v =		I y-z =	

Reset Open Save Save As Export to Mastan2 Close



Creating Section Properties – Cont.

- 1) Under the segments section, click the edit box to the right of **ID:** and enter **1**. Click the edit box to the right of **Start Node=** and enter **1**. Click the edit box to the right of **End Node=** and enter **2**. Click the edit box to the right of **Thickness=** and enter **0.1046**. Click **Add** to save the segment. 
- 2) Repeat entering the values for each segment updating the **ID:**, **Start Node=**, and **End Node=** values by adding **1** to each number until all 5 segments are entered. Click **Add** after each to save. 
- 3) Click **Calculate** to determine the properties. 
- 4) Click edit box to right of **Name:** and enter **Pour Stop**.
- 5) Click **Export to MASTAN2** to copy values to main program. Then click **Close** to return. 
- 6) Click **Apply** to save Section 1.



MSASect (Nonsymmetric Section)
_ □ ×

Nodes

2		ID:	6	Add
3		Z-Coor. =	-0.7107	Modify
4		Y-Coor. =	6.4806	Delete
5				
6				

Segments

1		ID:	1	Add
		Start Node =	1	Modify
		End Node =	2	Delete
		Thickness =	0.1046	

Calculate

Section View

(+)
(-) ← Z → (-)

Section Properties	Name: <input type="text"/>	Phi = <input type="text"/>	Status: <input type="text"/>
Area = <input type="text"/>	I z-z = <input type="text"/>	I y-y = <input type="text"/>	J = <input type="text"/> Cw = <input type="text"/>
Ysc = <input type="text"/>	Zsc = <input type="text"/>	BetaV = <input type="text"/>	BetaW = <input type="text"/> Betaw = <input type="text"/>
Z w-w = <input type="text"/>	Z v-v = <input type="text"/>	I y-z = <input type="text"/>	
Reset	Open	Save	Save As
			Export to Mastan2
			Close



MSASect (Nonsymmetric Section)

-Nodes-

2	ID:	6	Add
3	Z-Coor. =	-0.7107	Modify
4	Y-Coor. =	6.4806	Delete
5			
6			

-Segments-

1	ID:	5	Add
2	Start Node =	5	Modify
3	End Node =	6	Delete
4	Thickness =	0.1046	
5			

Section View

Calculate

Section Properties Name: Phi= Status:

Area = I z-z = I y-y = J = Cw =

Ysc = Zsc = BetaV = BetaW = Betaw =

Z w-w = Z v-v = I y-z =

Reset Open Save Save As Export to Mastan2 Close



MSASect (Nonsymmetric Section)
_ □ ×

Nodes

2	ID:	6	Add
3	Z-Coord.:	-0.7107	Modify
4	Y-Coord.:	6.4806	Delete
5			
6			

Segments

1	ID:	5	Add
2	Start Node=	5	Modify
3	End Node=	6	Delete
4	Thickness=	0.1046	
5			

Section View

(+) ←----- Z ----- (-)

(-) ----- Y ----- (+)

Calculate

Section Properties		Name:	Phi=	48.47	Status:	Calculated successfully!			
Area =	1.636e+00	I z-z =	9.415e+00	I y-y =	1.087e+01	J =	5.967e-03	Cw =	6.192e-01
Ysc =	-1.788e+00	Zsc =	2.228e+00	BetaV =	-1.082e+01	BetaW =	-1.277e+00	Betaw =	-1.276e+01
Z w-w =	4.531e+00	Z v-v =	2.248e+00					I y-z =	5.987e+00

Reset
Open
Save
Save As
Export to Mastan2
Close



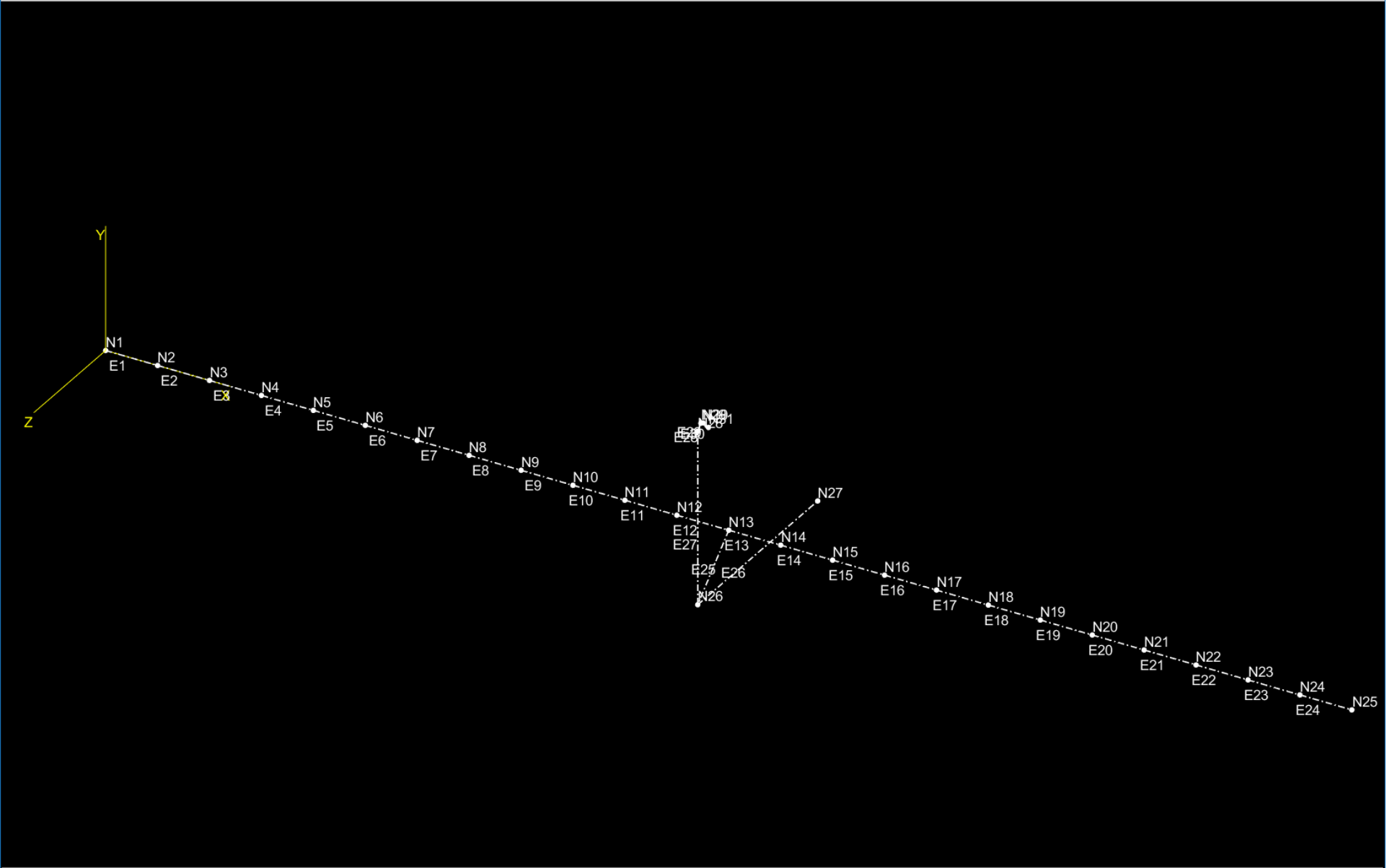

Please enter section properties		Section 1	Name:	Pour Stop	MSASect	Status:					
Area =	1.63617	I z-z =	9.41517	I y-y =	10.8745	J =	0.00596719	Cw =	0.619172	I y-z =	5.98661
Ysc =	-1.78816	Zsc =	2.22802	BetaV =	-10.8155	BetaW =	-1.27741	Betaw =	-12.7618	Advanced ▾	
Z w-w =	4.53052	Z v-v =	2.24768	A v-v =	inf	A w-w =	inf	Apply		Cancel	



Section Properties - Assigning

- 1) From the **Properties** menu select **Attach Section**.
- 2) At the bottom menu bar, use the buttons to the right of **Element(s):** to make the list of elements.
- 3) Create a list of the elements by clicking the **All** button.
- 4) Click on the **Apply** button to assign Section 1. 

MASTAN2



File View Geometry Properties Conditions Analysis Results

Select Section # and element(s) Element(s): All All Clr Adv Status: Success: Section attached.

Section # 1 Details: Pour Stop <Click to see properties> Apply Cancel



Material Properties

- 1) From the **Properties** menu select **Define Material**.
- 2) At the bottom menu bar, click in the edit box just to the right of **E=** and change the **0** to **29500000** (not 29,500,000). Similarly, click in the edit box just to the right of **Fy=** and change the **inf** to **33000**.
Next, click in the edit box to the right of **Name:** and type **Steel**. 
- 3) Click on the **Apply** button to save Material #1.
- 4) From the **Properties** menu select **Attach Material**.
- 5) At the bottom menu bar, create the list of elements to be assigned the properties of Material 1 by clicking on the **All** button to the right of **Elements:**. Click on the **Apply** button. 

Since the self-weight is already included in the loading summary, a self-weight was left as zero. If the self-weight was to be included through MASTAN2, a second weightless material would need to be defined and assigned to the members that are being used to visualize the cross section.



MASTAN2

File View Geometry Properties Conditions Analysis Results

Please enter material properties

Material 1	Name: Steel	Status:	Gravity assumed in -Y direction
E = 29500000	v = 0.3	Fy = 33000	Wt Dens. = 0
			Apply Cancel



MASTAN2



File View Geometry Properties Conditions Analysis Results

Select Material # and element(s) Element(s): All All Clr Adv Status: Success: Material attached.

Material # 1 Details: Steel <Click to see properties> Apply Cancel



Support Conditions

- 1) From the **Conditions** menu select **Define Fixities**.
- 2) At the bottom menu bar, define a pin support with torsion fixed support by clicking in the **check boxes** just to the left of **X-disp**, **Y-disp**, **Z-disp**, and **X-rot**.
- 3) Create the list of nodes to be assigned this fixity by clicking on node **1**.
- 4) Click on the **Apply** button. 
- 5) At the bottom menu bar, define a roller support with torsion fixed support by clicking in the **check boxes** just to the left of **X-disp** to release it and leave **Y-disp**, **Z-disp**, and **X-rot** constrained.
- 6) Click **Clr** to empty the list of nodes.
- 7) Create the list of nodes to be assigned this fixity by clicking on node **25**.
- 8) Click on the **Apply** button. 

MASTAN2

File View Geometry Properties Conditions Analysis Results

Please select node(s) and fixity(s) Node(s): 1 All Clr Adv Status: Success: Node fixities defined.

X-disp Y-disp Z-disp X-rot Y-rot Z-rot Apply Cancel



MASTAN2

File View Geometry Properties Conditions Analysis Results



Please select node(s) and fixity(s) Node(s): 25 All Clr Adv Status: Success: Node fixities defined.

X-disp Y-disp Z-disp X-rot Y-rot Z-rot

Apply Cancel



Adding Warping Effects

- 1) From the **Geometry** menu select **Define Connections** and submenu option **Torsion**.
- 2) At the bottom menu bar, click on the menu to the right of **Warping Restraint for Node i** and set the value to **Continuous**. Repeat this for the **Warping Restraint for Node j**.
- 3) Click the **Adv** button to open pop-up menu. Click the check box next to the **X-axis** option.
- 4) Create the list of elements to be assigned continuous warping by clicking on the **Add** button to the advanced menu. Then click on the **Apply** button. 
- 5) Click **Clr** to empty the list of elements. Click on the left most element of the beam.
- 6) Click on the menu to the right of **Warping Restraint for Node i** and set the value to **Free**. Node j is set from the previous step. Click on the **Apply** button. 
- 7) Click **Clr** to empty the list of elements. Click on the right most element of the beam. This might require you to click **Adv** to close the pop-up menu.
- 8) Click on the menu to the right of **Warping Restraint for Node i** and set the value to **Continuous**. Click on the menu to the right of **Warping Restraint for Node j** and set the value to **Free**.
- 9) Click on the **Apply** button. 



MASTAN2

File View Geometry Properties Conditions Analysis Results

Advanced Element Selection

Parallel to: On

X-axis

Y-axis

Z-axis

Range (Inclusive) Off

-inf X +inf

-inf Y +inf

-inf Z +inf

Add Remove Reset

Define element(s) and warping restraint Element(s): 1 2 3 4 5 6 7 8 9 10 11 All Clr Adv Status: Success: Warping Restraint defined.

Node i Warping Restraint Continuous Node j Warping Restraint Continuous Apply Cancel



MASTAN2

File View Geometry Properties Conditions Analysis Results

Advanced Element Selection

Parallel to: On

X-axis

Y-axis

Z-axis

Range (Inclusive): Off

-inf X +inf

-inf Y +inf

-inf Z +inf

Add Remove Reset

Define element(s) and warping restraint Element(s): 1 All Clr Adv Status: Success: Warping Restraint defined.

Node i Warping Restraint Free Node j Warping Restraint Continuous Apply Cancel



MASTAN2

File View Geometry Properties Conditions Analysis Results



Define element(s) and warping restraint Element(s): 24 All Clr Adv Status: Success: Warping Restraint defined.

Node i	Warping Restraint	Node j	Warping Restraint
	Continuous		Free

Apply Cancel



Loading

- 1) From the **Conditions** menu select **Define Forces**.
- 2) At the bottom menu bar, click in the edit box just to the right of **PY =** and change **0** to **-12.34**. Click in the edit box just to the right of **PZ =** and change **0** to **5.9**.
- 3) Click the **Adv** button to open the pop-up menu. To select the main beam nodes, change the edit box to the left of **Z** to **-1**. Change the edit box to the right of **Z** to **1**.
- 4) Click **Add** to add all main beam nodes.
- 5) Click on the **Apply** button. 
- 6) From the **Conditions** menu select **Define Moments**.
- 7) At the bottom menu bar, click in the edit box just to the right of **Mx =** and change **0** to **-17.42**.
- 8) Click the **Adv** button to open the pop-up menu. To select the main beam nodes, change the edit box to the left of **Z** to **-1**. Change the edit box to the right of **Z** to **1**.
- 9) Click **Add** to add all main beam nodes.
- 10) Click on the **Apply** button. 

MASTAN2

File View Geometry Properties Conditions Analysis Results

Advanced Node Selection

Range (Inclusive)

-Inf	X	Inf
-Inf	Y	Inf
-1	Z	1

Add Remove Reset

Please define node(s) and forces Node(s): 1 2 3 4 5 6 7 8 9 10 11 All Clr Adv Status: Success: Forces at nodes defined.

PX = 0 PY = -12.34 PZ = 5.9 Apply Cancel



MASTAN2

File View Geometry Properties Conditions Analysis Results

Advanced Node Selection

Range (Inclusive)

-Inf	X	Inf
-Inf	Y	Inf
-1	Z	1

Add Remove Reset

Please define node(s) and moments Node(s): 1 2 3 4 5 6 7 8 9 10 11 All Clr Adv Status: Success: Moments at nodes defined.

MX = -17.42 MY = 0 MZ = 0 Apply Cancel



Naming and Saving

These steps are technically optional as you can complete analysis without saving or applying a title; however, this is a good time to complete this.

- 1) From the **File** menu select **Define title**. At the bottom menu bar, click in the edit box to the right of **Title:** and type in a brief description of this effort. This text might include the model title, your name, and/or the assignment number. Click on the **Apply** button.
- 2) From the **File** menu select **Save As ...**. After selecting your destination folder, type in the filename **Pour_Stop** and click **Save**. Note that the top of the window has now changed to include the file name and directory as well as the time the file was last saved. 



MASTAN2: C:\Users\SSIRL\Desktop\Pour_Stop.mat [15:26]

File View Geometry Properties Conditions Analysis Results

Please enter title and select apply



Status: Success: Title defined.

Title: Pour Stop

Apply Cancel



First-Order Elastic Analysis

- 1) From the **Analysis** menu select **Static** and submenu option **1st-Order Elastic**.
- 2) At the bottom menu bar, the **Analysis Type:** should already be set to **Space Frame** as desired.
- 3) Click on the **Apply** button to perform the analysis. 
- 4) From the **Results** menu select **Diagrams** and submenu option **Deflected Shape**.
- 5) At the bottom menu bar, click on the **Apply** button. 
- 6) From the **Results** menu select **Node Displacements**.
- 7) On the undeflected shape, click on the midspan node of interest, node **13**, and the displacements for base 6 degree of freedoms are provided in the bottom menu bar. 

Results:

Disp X	Disp Y	Disp Z	Rot X	Rot Y	Rot Z
~0	-0.08033	-0.0598	-0.03472	~0	~0

- 8) Clicking on any of the additional nodes representing the cross section will cause the displacements at that location due the combined effects of rotation and translation to be displayed. These deflections do not account for any local axial displacement due to warping though.



MASTAN2: C:\Users\SSIRL\Desktop\Pour_Stop.mat [15:41]

File View Geometry Properties Conditions Analysis Results

First-Order Elastic Static Analysis Status: Applied Load Ratio = 1.000 ----> Success: Analysis Complete

Analysis Type: Space Frame Apply Cancel



MASTAN2: C:\Users\SSIRL\Desktop\Pour_Stop.mat [15:26]

File View Geometry Properties Conditions Analysis Results

Deflected Shape: 1st-Order Elastic, Incr # 1, Applied Load Ratio = 1

Define element(s) and parameters

Element(s):	All	All	Clr	Adv	Status:	Success: Deflection shown			
Defl Line Type	Solid	Scale	10	# of pts	10	<input type="checkbox"/> Animate	(1) 1.000	Apply	Cancel



MASTAN2: C:\Users\SSIRL\Desktop\Pour_Stop.mat [15:26]



File View Geometry Properties Conditions Analysis Results

Deflected Shape: 1st-Order Elastic, Incr # 1, Applied Load Ratio = 1

Node:	13	Disp X	-2.212e-12	Disp Y	-0.08033	Disp Z	-0.0598	Status:	Success: Disp. at ALR = 1.0000
Displacements	Rot X	-0.03472	Rot Y	-6.085e-14	Rot Z	3.126e-13	(1) 1.000	Apply	Cancel



Second-Order Elastic Analysis

- 1) From the **Analysis** menu select **Static** and submenu option **2nd-Order Elastic**.
- 2) At the bottom menu bar, the **Analysis Type:** should already be set to **Space Frame** as desired.
- 3) Click on the **Apply** button to perform the analysis. 
- 4) From the **Results** menu select **Diagrams** and submenu option **Deflected Shape**.
- 5) At the bottom menu bar, click on the **Apply** button. 
- 6) From the **Results** menu select **Node Displacements**.
- 7) On the undeflected shape, click on the midspan node of interest, node **13**, and the displacements for base 6 degree of freedoms are provided in the bottom menu bar. 

Results:

Disp X	Disp Y	Disp Z	Rot X	Rot Y	Rot Z
-2.992e-4	-0.08758	-0.06218	-0.03726	~0	~0

The values are similar to the 1st-order results but capture the change in the applied torsion that exists in the deformed condition. The analysis does not account for any change in the direction the load would be applied. The applied loads will remain in the initial orientation.



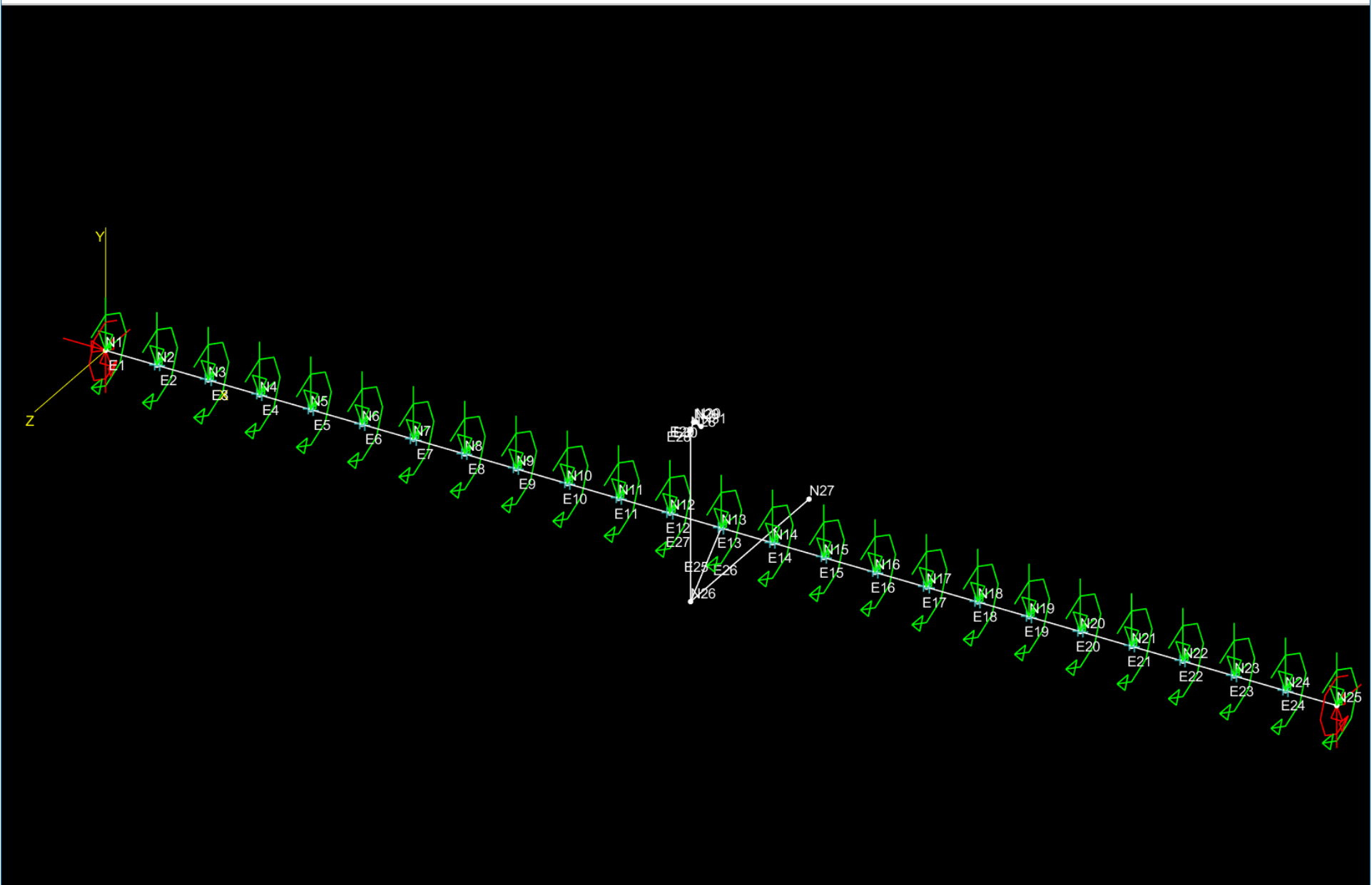

Second-Order Elastic Static Analysis		Status:	Incr # 10, Applied Load Ratio = 1.000 --> Success: Analysis Complete				
Solution Type:	Predictor-Corrector	Incr Size:	0.1	Max. # of Incrs:	10	Max. Appl. Ratio:	1
Analysis Type:	Space Frame	<input type="checkbox"/> [Kff]	Start New	Apply	Cancel		



MASTAN2: C:\Users\SSIRL\Desktop\Pour_Stop.mat [15:26]

File View Geometry Properties Conditions Analysis Results

**** Deflected Shape: 2nd-Order Elastic, Incr # 10, Applied Load Ratio = 1 ****

Define element(s) and parameters

Element(s):	All	All	Clr	Adv	Status:	Success: Deflection shown			
Defl Line Type	Solid	Scale	10	# of pts	10	<input type="checkbox"/> Animate	(10) 1.000	Apply	Cancel



**** Deflected Shape: 2nd-Order Elastic, Incr # 10, Applied Load Ratio = 1 ****

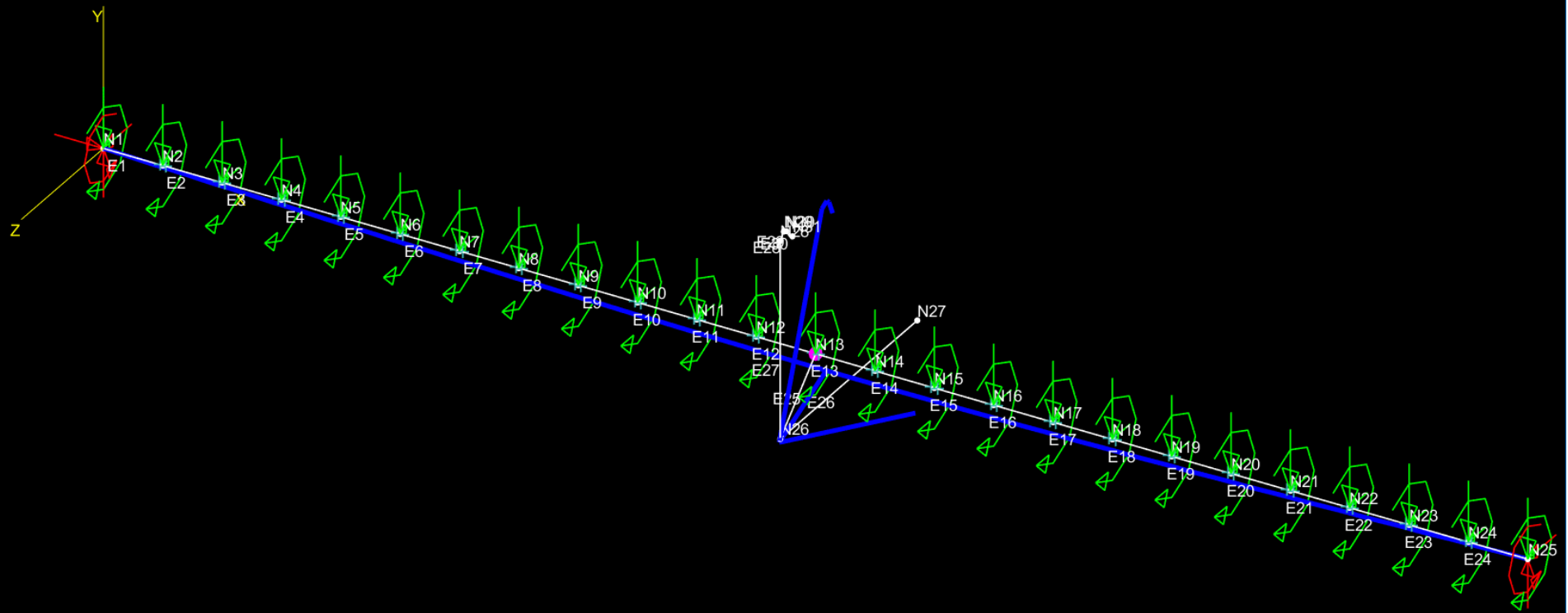

Node:	13	Disp X	-0.0002992	Disp Y	-0.08758	Disp Z	-0.06218	Status:	Success: Disp. at ALR = 1.0000
Displacements	Rot X	-0.03726	Rot Y	-7.556e-09	Rot Z	-9.059e-09	(10) 1.000	Apply	Cancel



Section 4: Results and Stresses

Using Internal Forces

The next section of this tutorial will provide instructions on how it is possible to calculate the internal stresses from the MASTAN2 output information. After showing how to locate the necessary information from within MASTAN2, the next few pages will provide background and the sign conventions that are used with MASTAN2 to calculate the internal stresses. Some information is provided on how this information can be calculated. Finally, the resulting stresses at midspan are identified using the 2nd-order analysis internal forces.

Notes:

The internal forces taken from MASTAN2 are presented with the sign convention shown on the following page. Also included are the required transformations to get to a principal orientation. 

The stress calculations will account for this information.



Sign Conventions

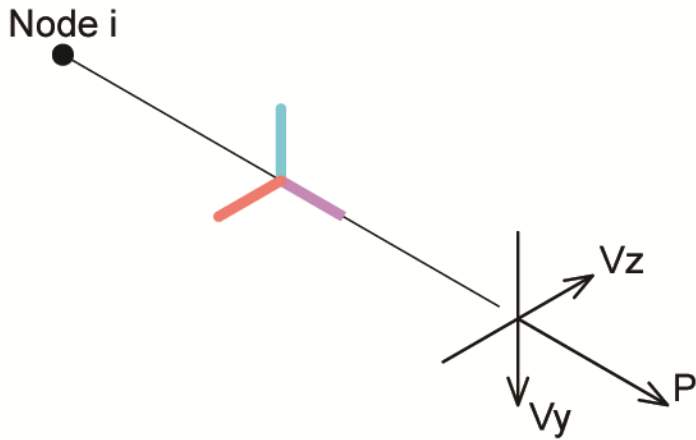

$$\begin{bmatrix} V_v \\ V_w \end{bmatrix} = \begin{bmatrix} \cos\phi & \sin\phi \\ -\sin\phi & \cos\phi \end{bmatrix} \cdot \begin{bmatrix} V_y \\ V_z \end{bmatrix}$$

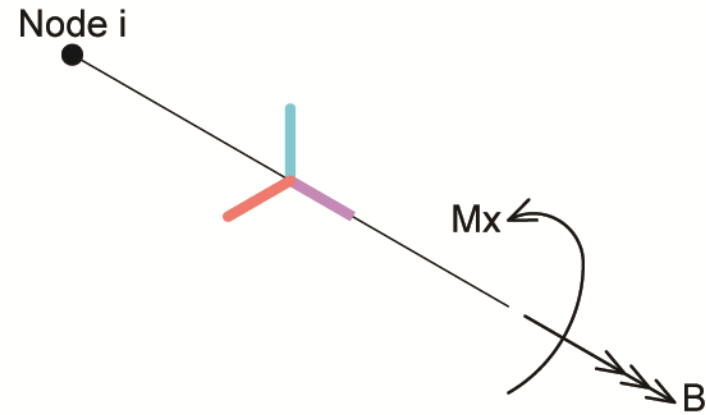

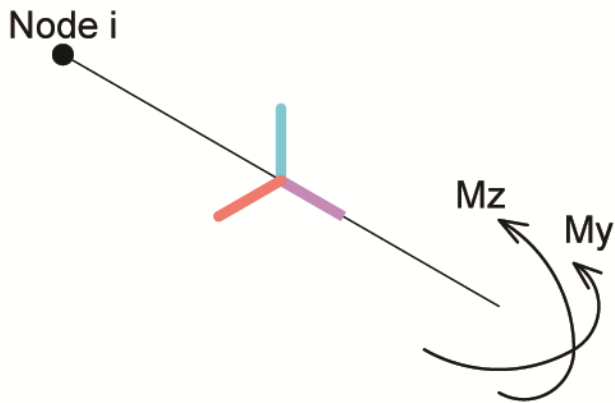

$$\begin{bmatrix} v_s \\ w_s \end{bmatrix} = \begin{bmatrix} \cos\phi & \sin\phi \\ -\sin\phi & \cos\phi \end{bmatrix} \cdot \begin{bmatrix} y_s \\ z_s \end{bmatrix}$$



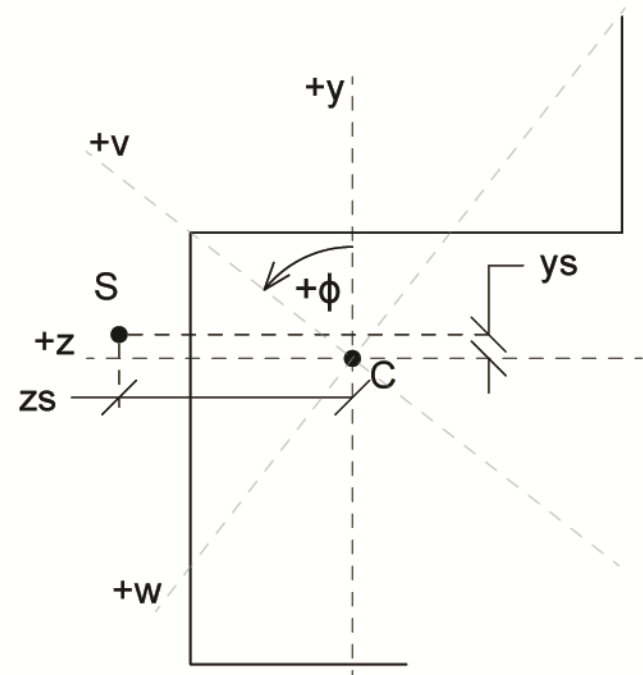

$$\begin{bmatrix} M_v \\ M_w \end{bmatrix} = \begin{bmatrix} \cos\phi & -\sin\phi \\ \sin\phi & \cos\phi \end{bmatrix} \cdot \begin{bmatrix} M_y \\ M_z \end{bmatrix}$$



Getting Internal Forces

- 1) From the **Results** menu select **Element Forces**.
- 2) On the undeflected shape, click on the element of interest, element **13**, and the internal forces are provided in the bottom menu bar. These are the forces at the start of the member and the middle of the beam. 
- 3) These forces will be used to calculate the stresses at the middle of the beam.
- 4) At the bottom menu bar, drag the slider in the left-hand corner until the position indicator located to the right displays **1.00L**.
- 5) Click on the **Apply** button. These are the forces at the end of the member. 
- 6) From this position, the bimoment is required to appropriately divide the longitudinal moment into the standard twisting and warping components for stress calculations.
- 7) Repeat steps 2 through 5 for element **1** to obtain the end forces to calculate the controlling shear location.

Forces at the start of element 1 

Forces at the end of element 1 



**** Deflected Shape: 2nd-Order Elastic, Incr # 10, Applied Load Ratio = 1 ****

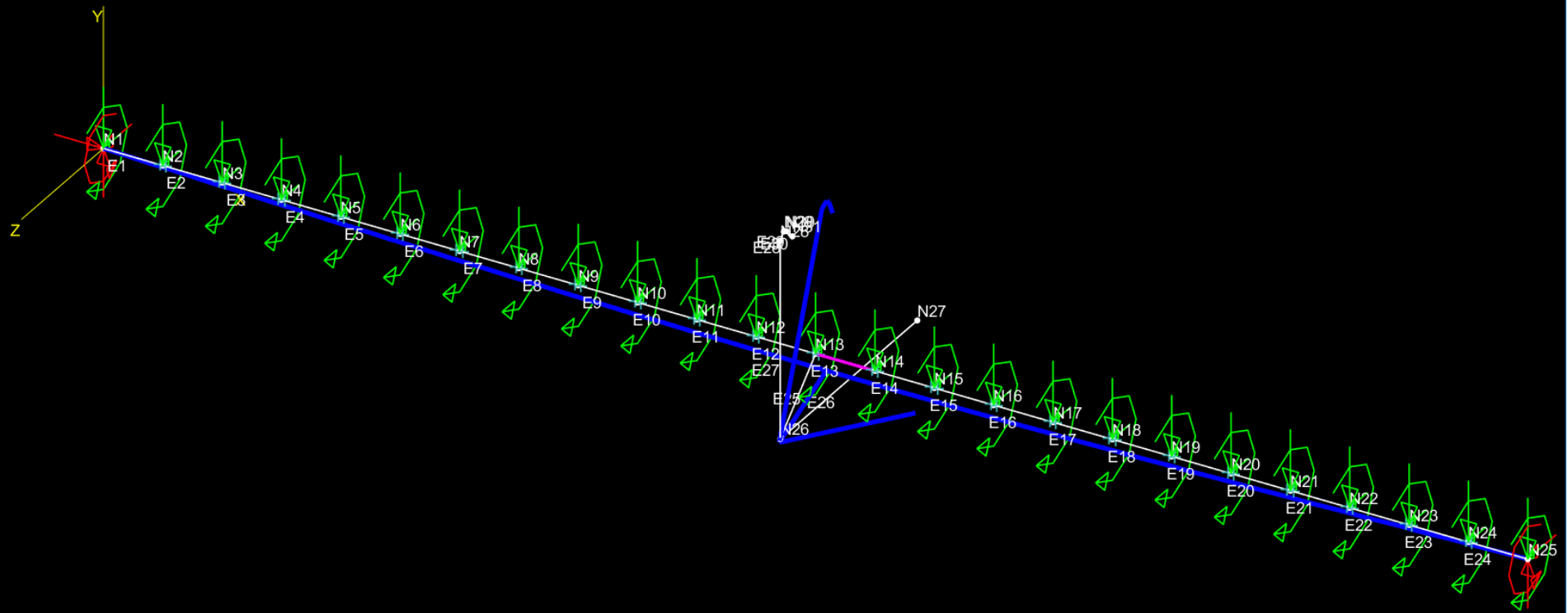

El #	13	N13:N14	P	0.001548	Vy	-6.275	Vz	2.719	(10) 1.000	Success: El Forces at ALR = 1.0000			
<		>	0.00L	Tx	10.98	My	-765.8	Mz	1815	B	2823	Apply	Cancel



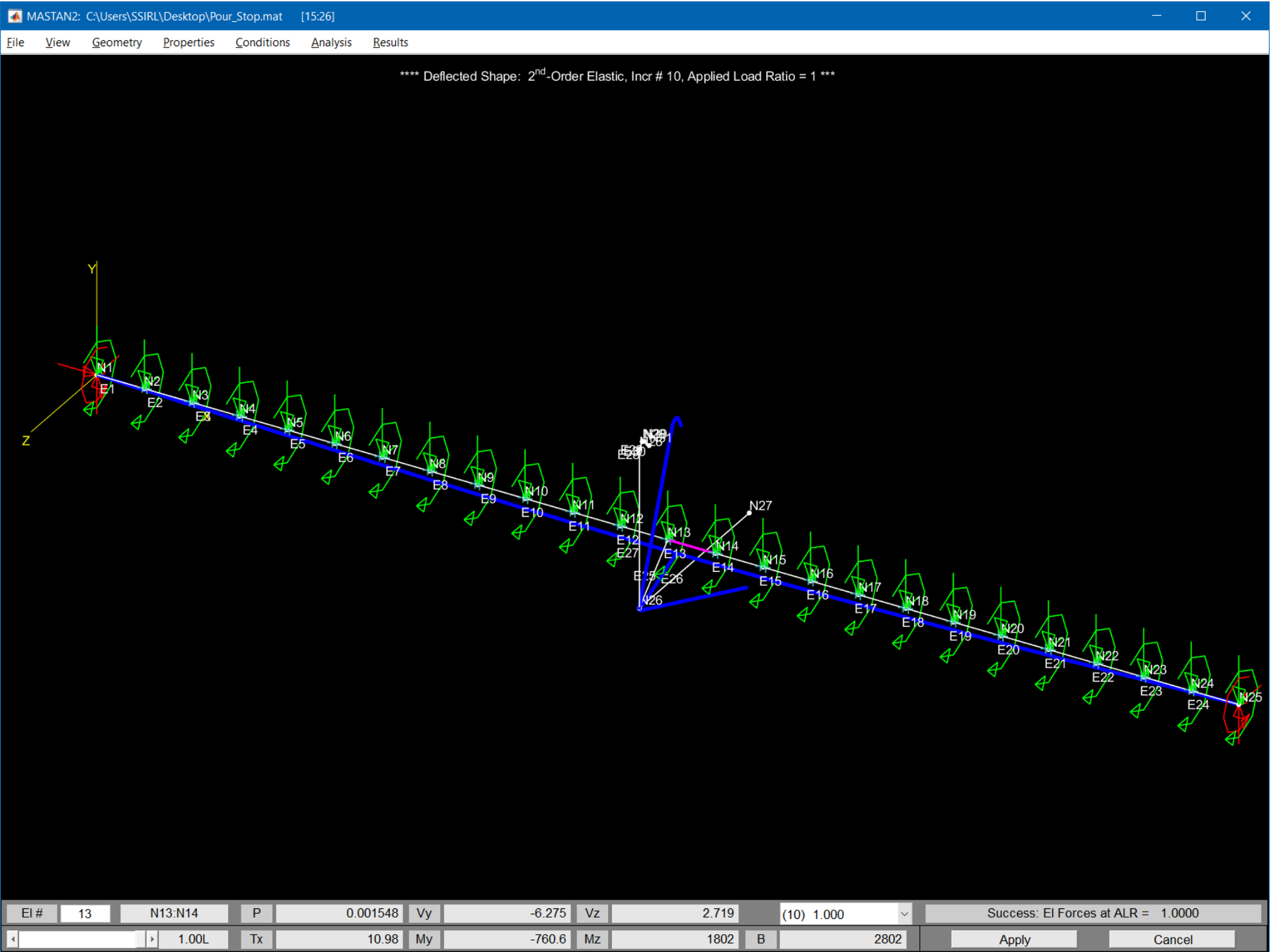

**** Deflected Shape: 2nd-Order Elastic, Incr # 10, Applied Load Ratio = 1 ****

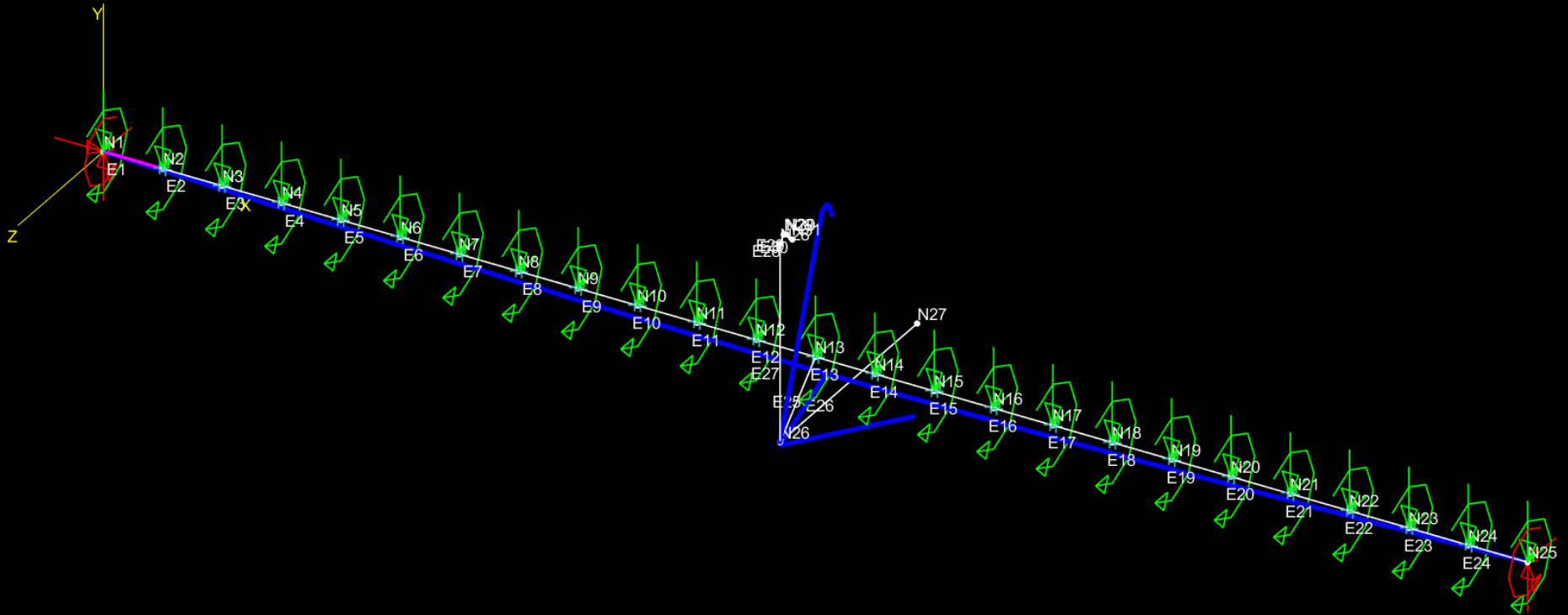

El #	1	N1:N2	P	0.5392	Vy	142.1	Vz	-67.5	(10) 1.000	Success: El Forces at ALR = 1.0000
		0.00L	Tx	-208.7	My	1.211	Mz	-0.8825	B	4.327e-11

Apply Cancel



**** Deflected Shape: 2nd-Order Elastic, Incr # 10, Applied Load Ratio = 1 ****

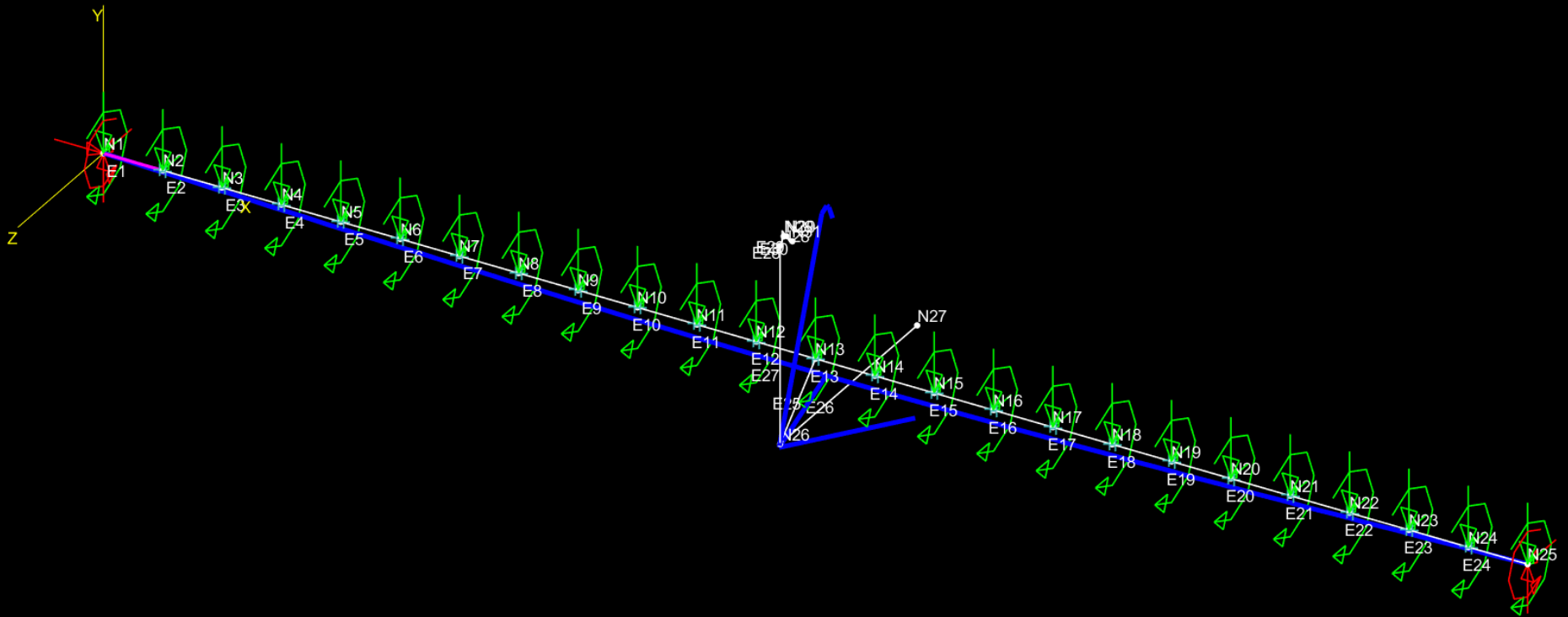

El #	1	N1:N2	P	0.5392	Vy	142.1	Vz	-67.5	(10) 1.000	Success: El Forces at ALR = 1.0000
		1.00L	Tx	-208.7	My	-133.4	Mz	283.4	B	482.4

Success: El Forces at ALR = 1.0000

Apply Cancel



Normal Stresses

The internal normal stresses can be calculated in the geometric orientation by

$$\sigma_x = \frac{P}{A} - \frac{(M_y I_{yz} + M_z I_{yy})y + (M_y I_{zz} + M_z I_{yz})z}{I_{yy} I_{zz} - I_{yz}^2} + \frac{B \omega_n}{C_\omega}$$

This relationship simplifies when working in the principal orientation to

$$\sigma_x = \frac{P}{A} - \frac{M_w v}{I_{ww}} - \frac{M_v w}{I_{vv}} + \frac{B \omega_n}{C_\omega}$$

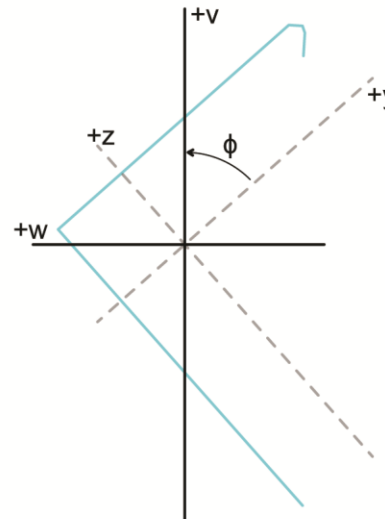
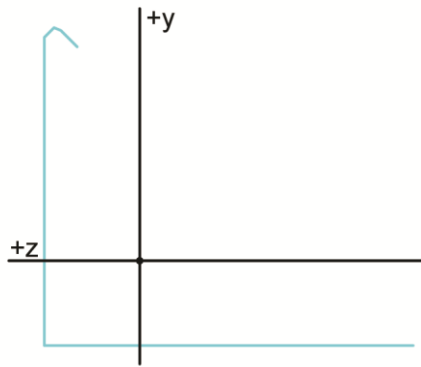

Shear Stresses

As part of calculating the shear stresses, the torsional moment must be separated into the component from twisting and the component of warping.

$$M_x - z_s V_y + y_s V_z = M_x - w_s V_v + v_s V_w = T_T - T_\omega$$

$$T_\omega = \frac{d}{dx} B \approx \frac{\Delta B}{\Delta L}$$

The maximum shear stress is the combination of the stress from transverse shear (τ_V), the change in bimoment (τ_B), and torsion (τ_T). The transverse and warping terms are approximately uniform across the thickness of the element, whereas torsion linearly varies across the thickness with the extreme value at the surface.

$$\tau_V = \frac{(-V_z I_{yz} + V_y I_{yy})\bar{y} + (V_z I_{zz} - V_y I_{yz})\bar{z}}{(I_{yy} I_{zz} - I_{yz}^2)t} A_s$$

$$\tau_V = \frac{V_v \bar{v}}{I_{ww} t} A_s + \frac{V_w \bar{w}}{I_{vv} t} A_s$$

$$\tau_B = -\frac{T_\omega S_\omega}{I_\omega} \qquad \tau_T = \frac{T_T t}{J}$$



Calculating Warping Constants

Determining the stresses from warping, both shear stresses and normal stresses, requires the use of warping coefficients. The values can be calculated based on the equations show below with additional details in the following documents. These documents also provide additional information on the stresses calculated as well.

(1) AISC Design Guide 9 (Paul A. Seaburg and Charles J. Carter, 2003)

(2) SDI Technical Note 3. (Steel Deck Institute, 2018)

$$\omega_{ns} = \frac{1}{A} \int_0^b \omega_{os} t ds - \omega_{os}$$

$$\omega_{os} = \int_0^s \rho_0 ds$$

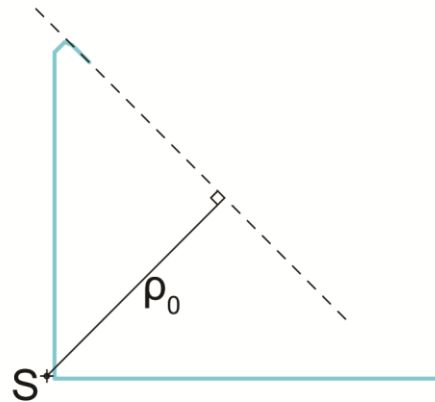



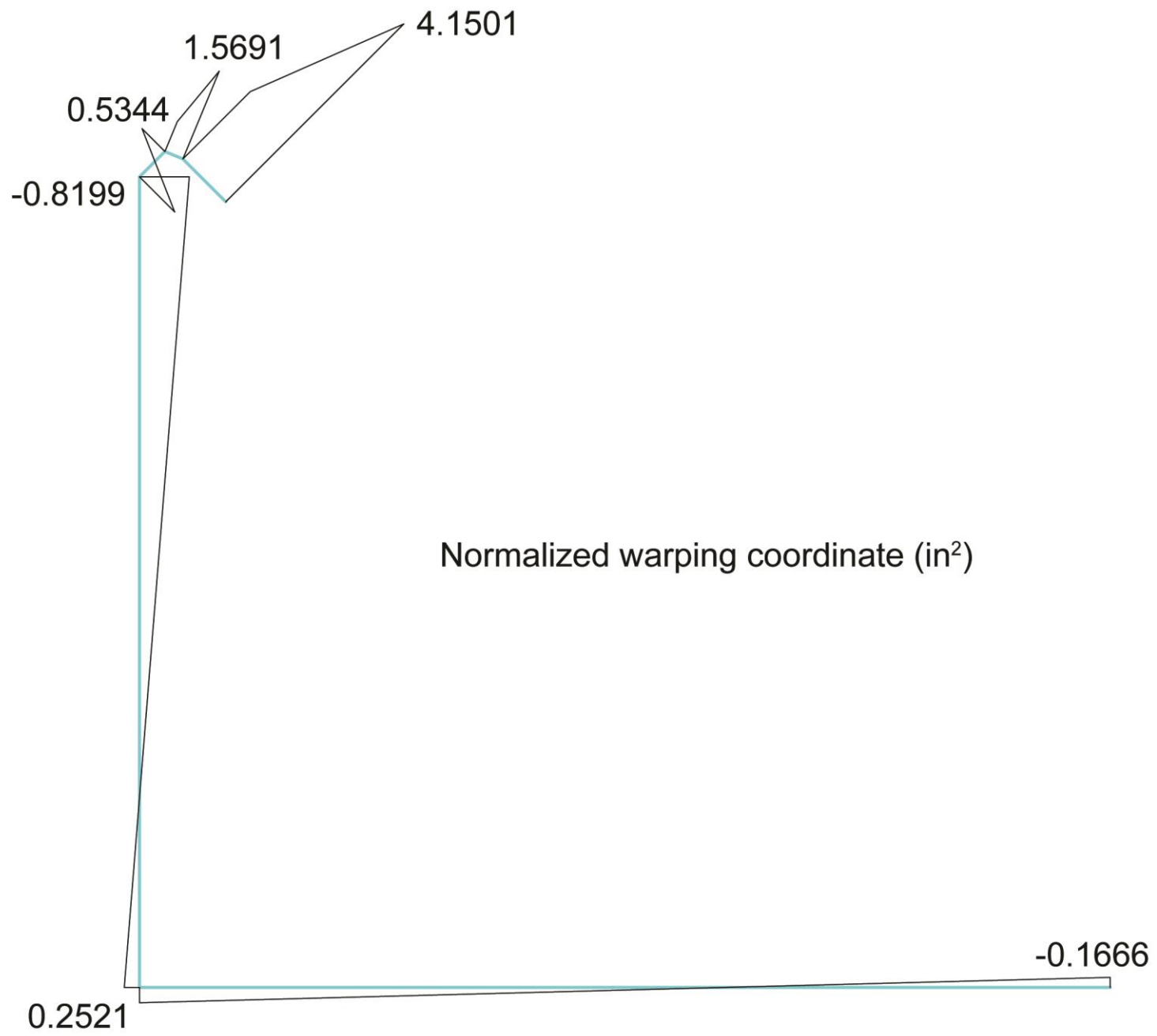

Different programs exist that can assist in this calculation. One alternative is to make use of CUFSM to calculate these values. The values for the current section are shown here. 





Resulting Internal Stresses

Each of the items below will link to a stress distribution for the centerline. Note moments and shears below are in the principal orientation.

- 1) Axial stress from bending moment: M_y & M_z & Axial stress from warping: B 
- 2) Total axial stress from P , M_y , M_z , & B 
- 3) Shear stress from transverse shear: V_y & V_z & Shear stress from warping: T_w 
- 4) Combined shear stress from V_y , V_z , & T_w & Shear stress from twisting: T_T 

No total combined shear stress is shown as the warping and transverse shear stress components are the same across the thickness of the section while the torsional component varies linearly across the thickness of the section with 0 stress at the centerline to \pm the value shown at the extremes.



Normal Stresses (ksi)
Red - Tension, Blue - Compression

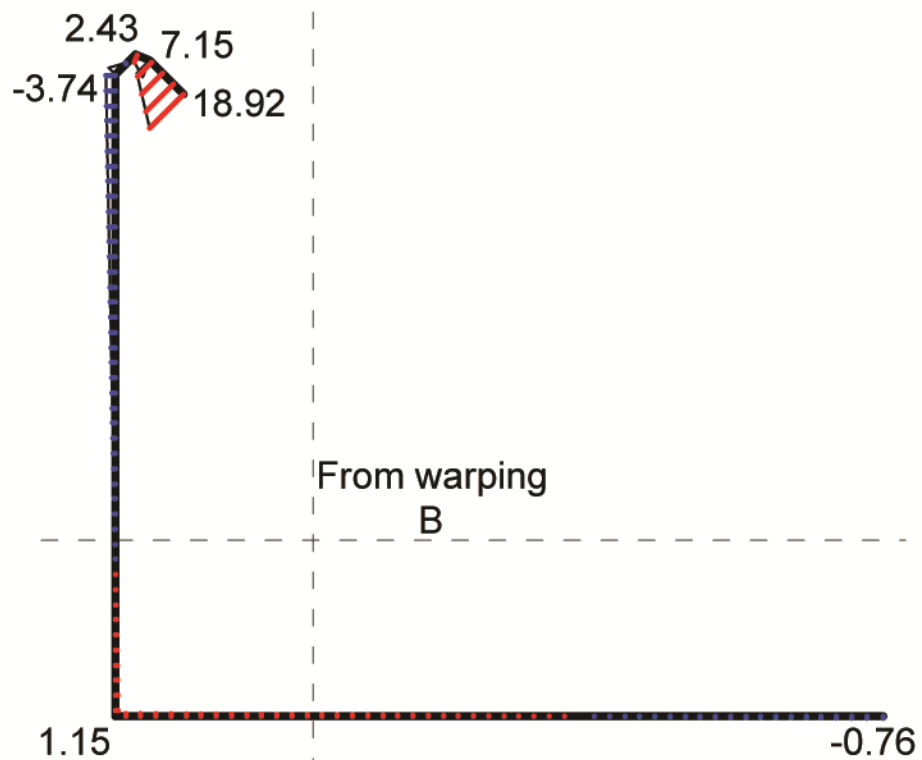
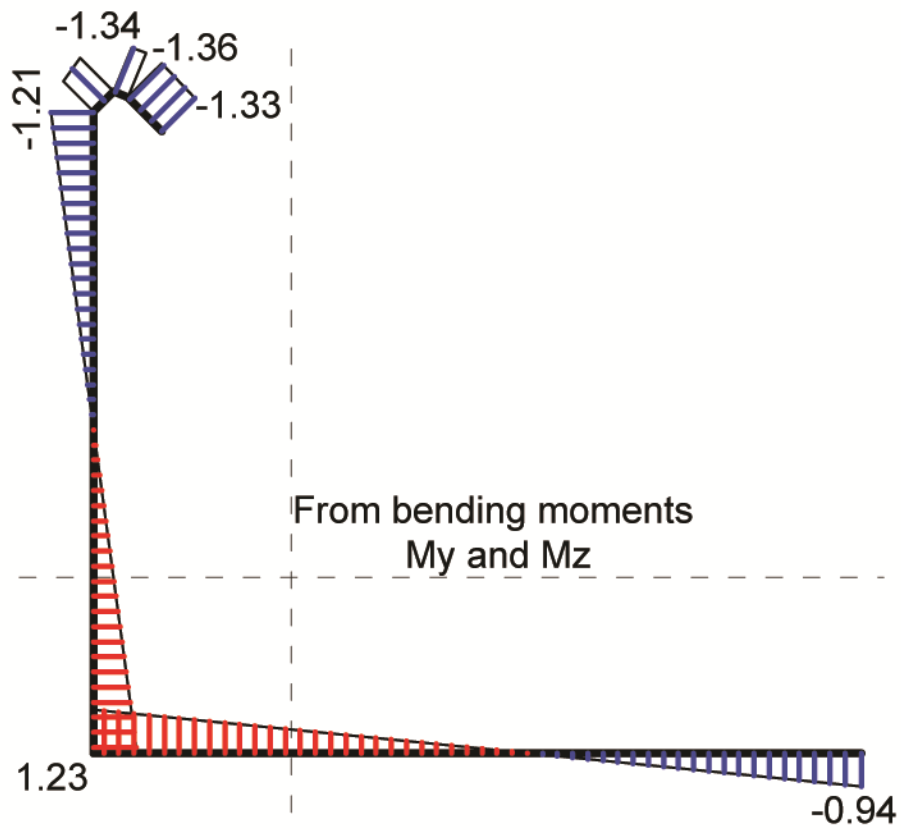

Normal Stresses (ksi)
Red - Tension, Blue - Compression

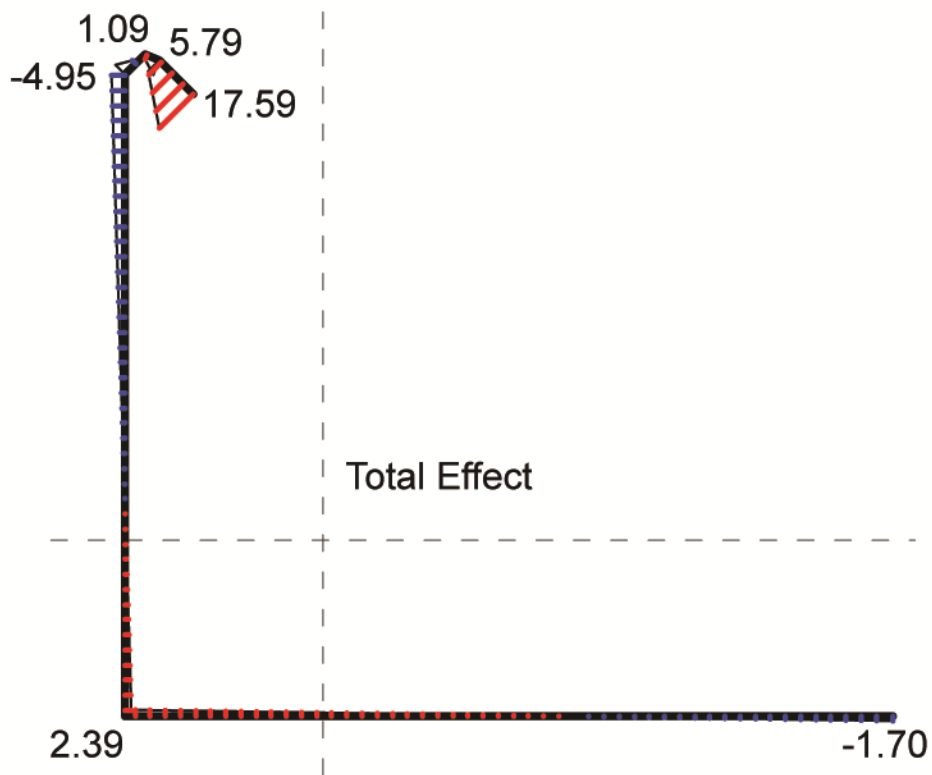

Shear Stresses (ksi)
Red - CCW, Blue - CW

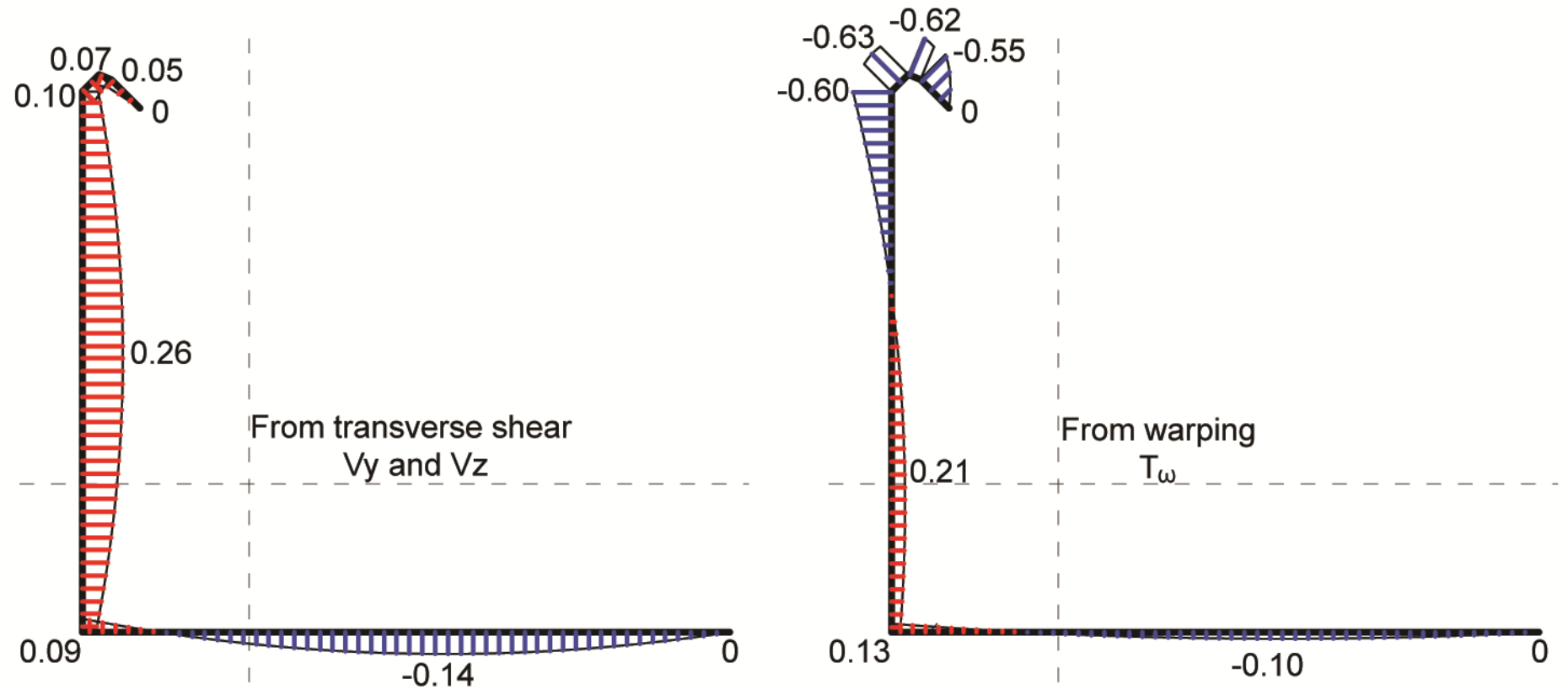

Results do not account for increase that could be considered in shear forces and torsion since part of the end point loads would be on this member.



Shear Stresses (ksi)
Red - CCW, Blue - CW

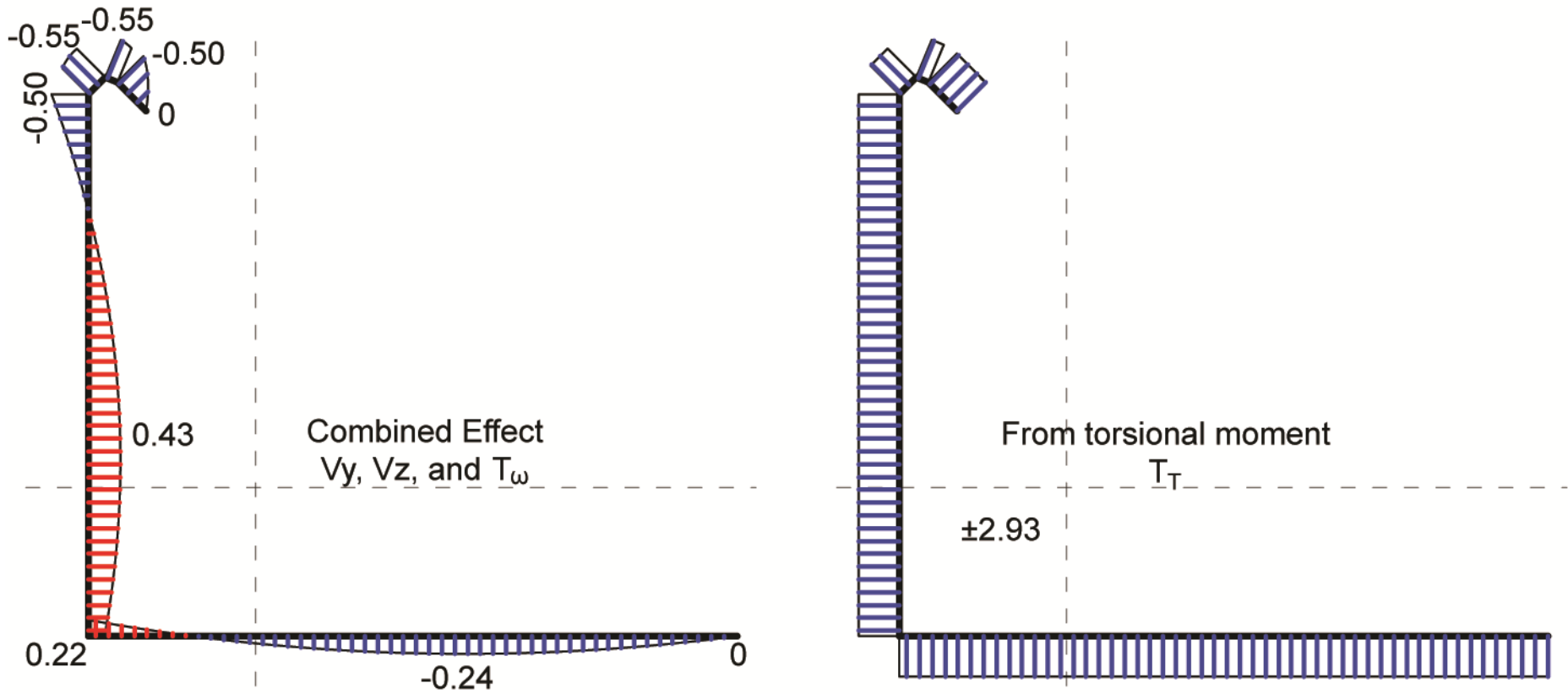

Results do not account for increase that could be considered in shear forces and torsion since part of the end point loads would be on this member.



Section 5: Additional Options

Other Possibilities



MASTAN2 has many options of what can be done. For this tutorial, three ideas are presented. Each possibility is completed starting with the initial model completed to this point. To compare to each of the following, it is recommended to make sure you have a base version of this model saved to be able to start over.

- 1) Applying uniform loading instead of point loads for the lateral loading.
- 2) Adjusting the boundary conditions to consider the effects of fixed warping.
- 3) Updating the model to calculate the results for other lengths or check other critical geometry.



1) Uniform Loading

While a distributed moment loading is not currently available in MASTAN2, it would be possible to use a distributed uniform load instead of point loads using the steps below.

- 1) From the **Conditions** menu select **Define Forces**.
- 2) At the bottom menu bar, all loads should be **0**.
- 3) Click the **All** button to populate the list of nodes.
- 4) Click on the **Apply** button to remove all point loads. 
- 5) From the **Conditions** menu select **Define Uniform Loads**.
- 6) At the bottom menu bar, click on **Element(s) local x'-y'-z'** to open the drop-down menu. Select **System global X-Y-Z**.
- 7) Click in the edit box just to the right of **Wy =** and change **0** to **-6.17**. Click in the edit box just to the right of **Wz =** and change **0** to **-2.95**. Click the **Adv** button to open pop-up menu. Ensure the check box next to the **X-axis** option is selected.
- 8) Click **Add** to add the main beam elements to the element list.
- 9) Click on the **Apply** button. 



MASTAN2: C:\Users\SSIRL\Desktop\Pour_Stop.mat [16:04]

File View Geometry Properties Conditions Analysis Results

Please define node(s) and forces

Node(s):	All	All	Clr	Adv	Status:		
PX =	0	PY =	0	PZ =	0	Apply	Cancel



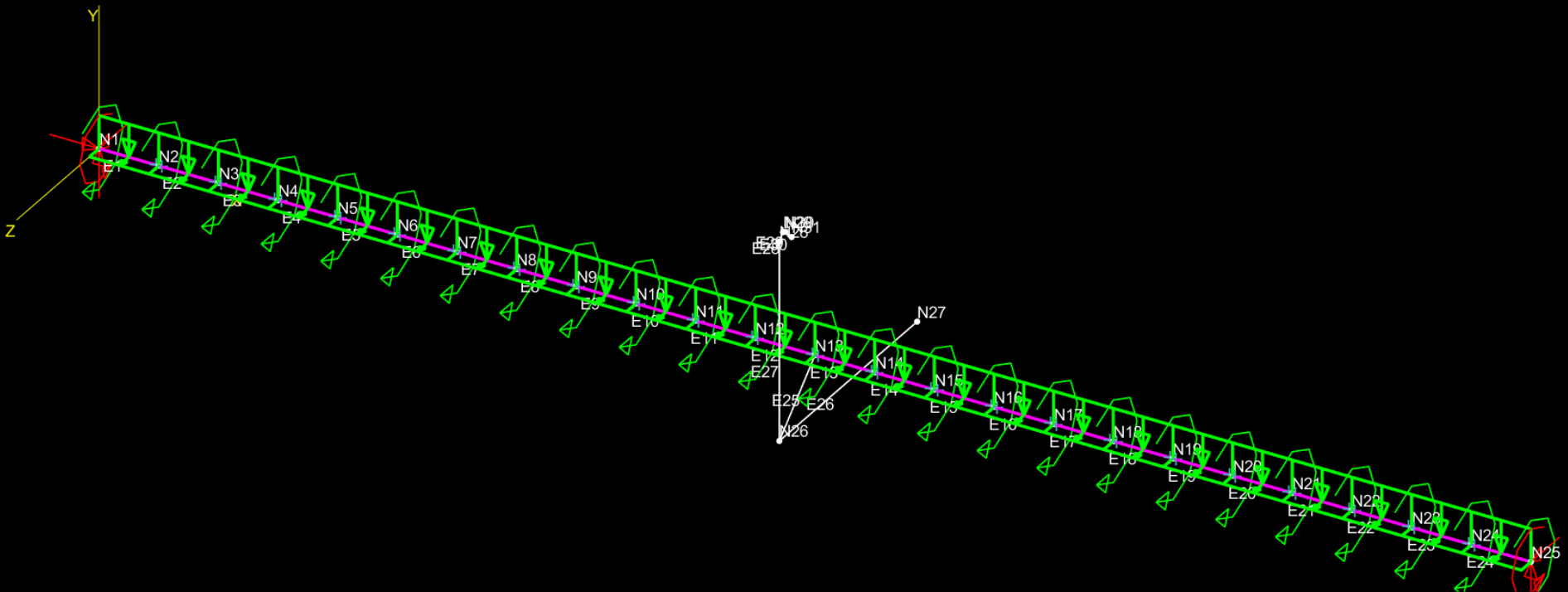

Advanced Element Selection

Parallel to: On

X-axis

Y-axis

Z-axis

Range (Inclusive) Off

-Inf	X	Inf
-Inf	Y	Inf
-Inf	Z	Inf

Add Remove Reset

Please define element(s) and loads Element(s): 1 2 3 4 5 6 7 8 9 10 11 All Clr Adv Status: Success: Element loads defined.

Input ref. System global X-Y-Z wx 0 wy -6.17 wz 2.95 Apply Cancel



1) Uniform Loading -- Second-Order Elastic Analysis

- 1) From the **Analysis** menu select **Static** and submenu option **2nd-Order Elastic**.
- 2) At the bottom menu bar, the **Analysis Type:** should already be set to **Space Frame** as desired.
- 3) Click on the **Apply** button to perform the analysis.
- 4) From the **Results** menu select **Node Displacements**.
- 5) On the undeflected shape, click on the midspan node of interest, node **13**, and the displacements for base 6 degree of freedoms are provided in the bottom menu bar. 

Results:

Disp X	Disp Y	Disp Z	Rot X	Rot Y	Rot Z
-2.992e-4	-0.08758	-0.06217	-0.03726	~0	~0

The values are similar to using point loads as the model was meshed adequately. If one would be working with less elements with a longer length, a greater variation would be expected with bending moment. There is not an effect of distributed torsion included.



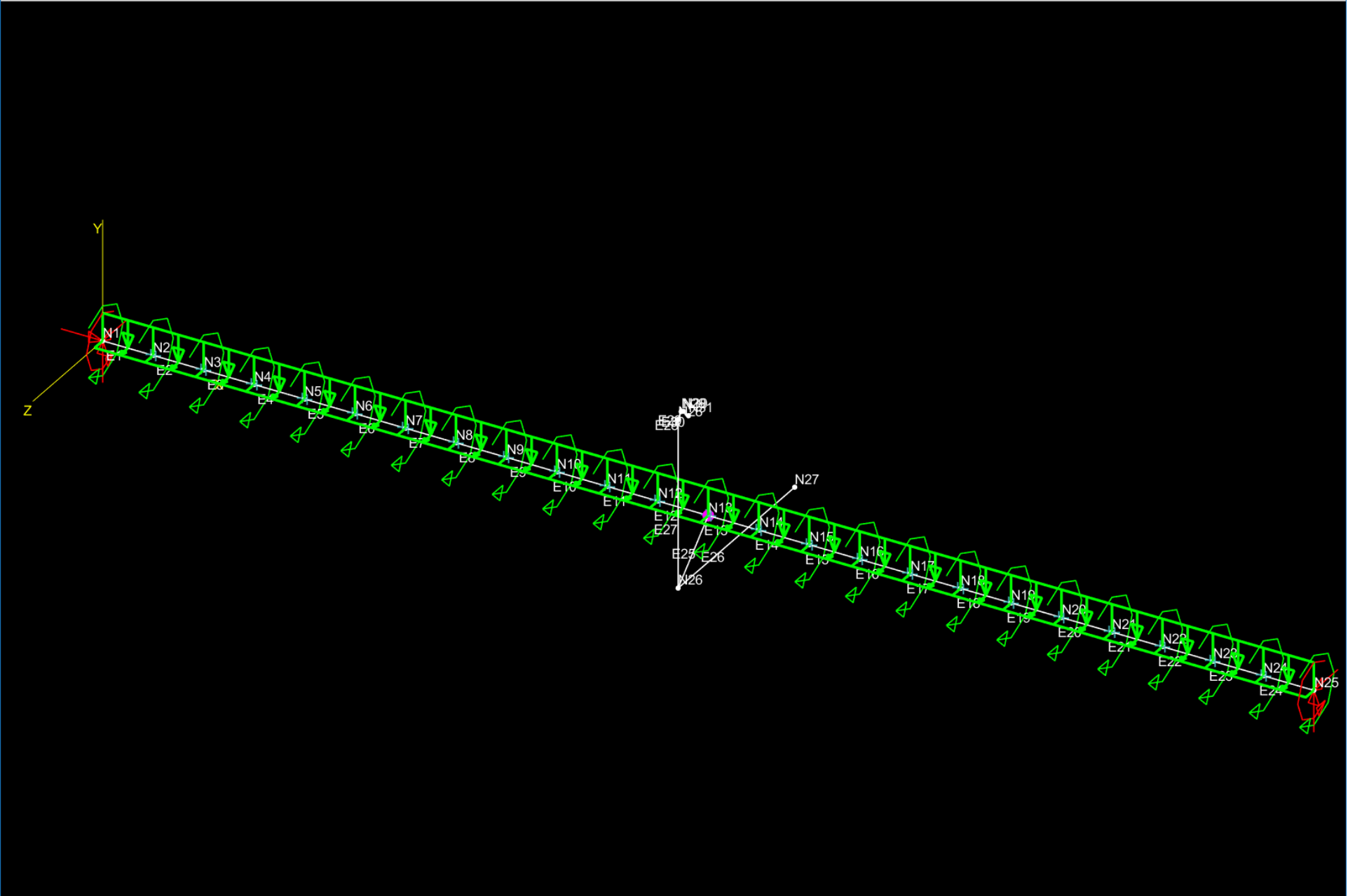



Node:	13	Disp X	-0.0002992	Disp Y	-0.08758	Disp Z	-0.06217	Status:	Success: Disp. at ALR = 1.0000
Displacements	Rot X	-0.03726	Rot Y	-7.553e-09	Rot Z	-9.063e-09	(10) 1.000	Apply	Cancel



2) Alternate Boundary Conditions

The use of MASTAN2 allows for different boundary conditions. While the model does not need to have symmetric supports, for a reference solution the ends were left as pin supports with torsion fixed while the warping constraint was changed to fixed.

- 1) From the **Geometry** menu select **Define Connections** and submenu option **Torsion**.
- 2) Click on the left most element of the beam.
- 3) At the bottom menu bar, click on the menu to the right of **Warping Restraint for Node i** and set the value to **Fixed**. Click on the menu to the right of **Warping Restraint for Node j** and set the value to **Continuous**.
- 4) Click on the **Apply** button. 
- 5) Click **Clr** to empty the list of elements. Click on the right most element of the beam. This might require you to click **Adv** to close the pop-up menu.
- 6) Click on the menu to the right of **Warping Restraint for Node i** and set the value to **Continuous**. Click on the menu to the right of **Warping Restraint for Node j** and set the value to **Fixed**.
- 7) Click on the **Apply** button. 



MASTAN2: C:\Users\SSIRL\Desktop\Pour_Stop.mat

File View Geometry Properties Conditions Analysis Results

Define element(s) and warping restraint

Element(s):	1	All	Clr	Adv	Status:	Success: Warping Restraint defined.	
Node i	Warping Restraint	Fixed	Node j	Warping Restraint	Continuous	Apply	Cancel



MASTAN2: C:\Users\SSIRL\Desktop\Pour_Stop.mat

File View Geometry Properties Conditions Analysis Results

Define element(s) and warping restraint

Element(s):	24	All	Clr	Adv	Status:	Success: Warping Restraint defined.	
Node i	Warping Restraint	Continuous	Node j	Warping Restraint	Fixed	Apply	Cancel



2) Alternate Boundary Conditions -- 2nd-Order Elastic Analysis

- 1) From the **Analysis** menu select **Static** and submenu option **2nd-Order Elastic**.
- 2) At the bottom menu bar, the **Analysis Type:** should already be set to **Space Frame** as desired.
- 3) Click on the **Apply** button to perform the analysis.
- 4) From the **Results** menu select **Node Displacements**.
- 5) Click on the midspan node of interest, node **13**, and the displacements for base 6 degree of freedoms are provided in the bottom menu bar. 

Results:

Disp X	Disp Y	Disp Z	Rot X	Rot Y	Rot Z
-2.684e-5	-0.02776	-0.01727	-0.01106	~0	~0

- 6) From the **Results** menu select **Element Forces**.
- 7) On the undeflected shape, click on the element of interest, element **13**, and the internal forces are provided in the bottom menu bar. These are the forces at the start of the member and the middle of the beam. 



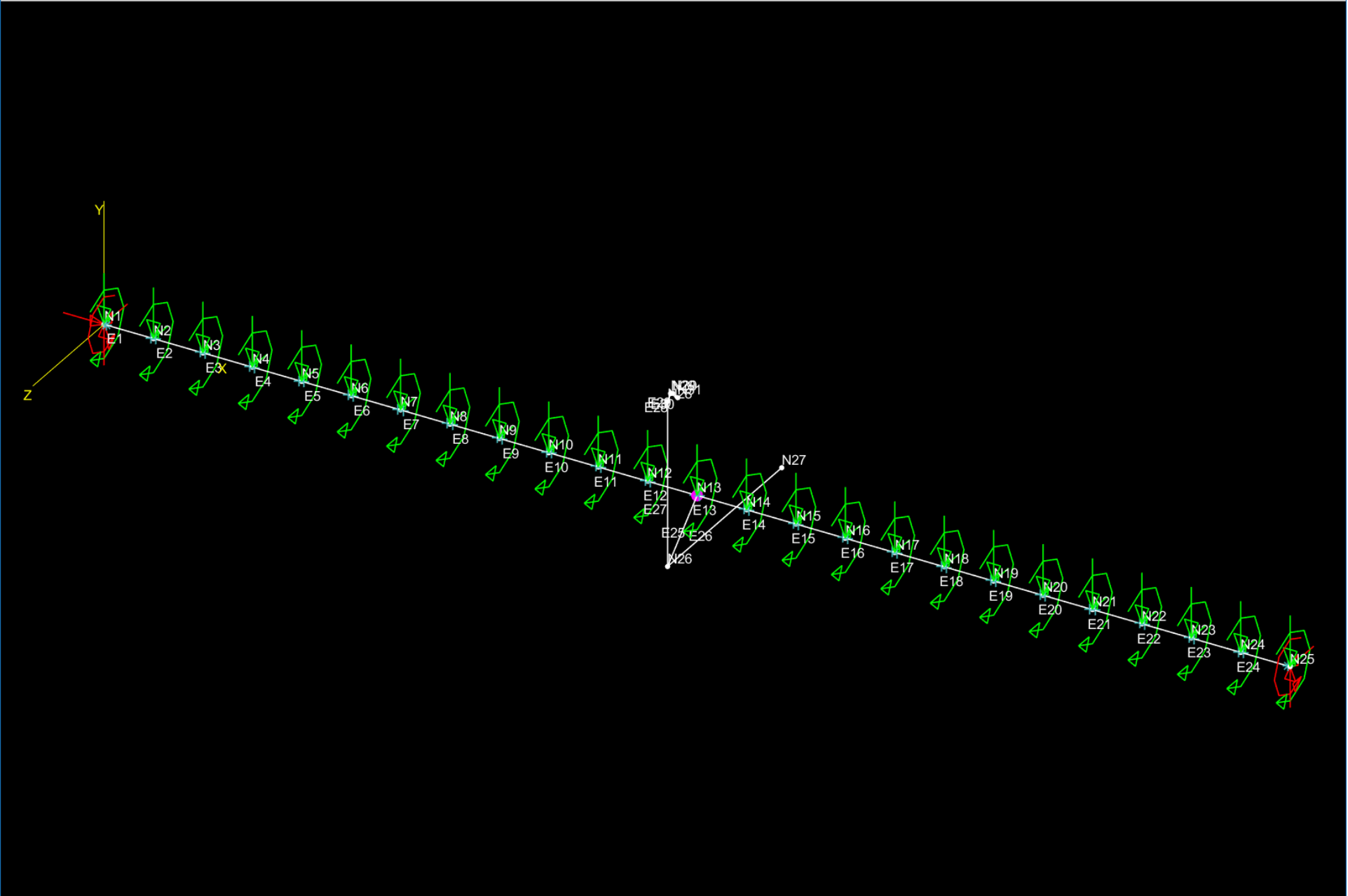

Node:	13	Disp X	-2.684e-05	Disp Y	-0.02776	Disp Z	-0.01727	Status:	Success: Disp. at ALR = 1.0000
Displacements	Rot X	-0.01106	Rot Y	1.089e-10	Rot Z	-4.399e-10	(10) 1.000	Apply	Cancel



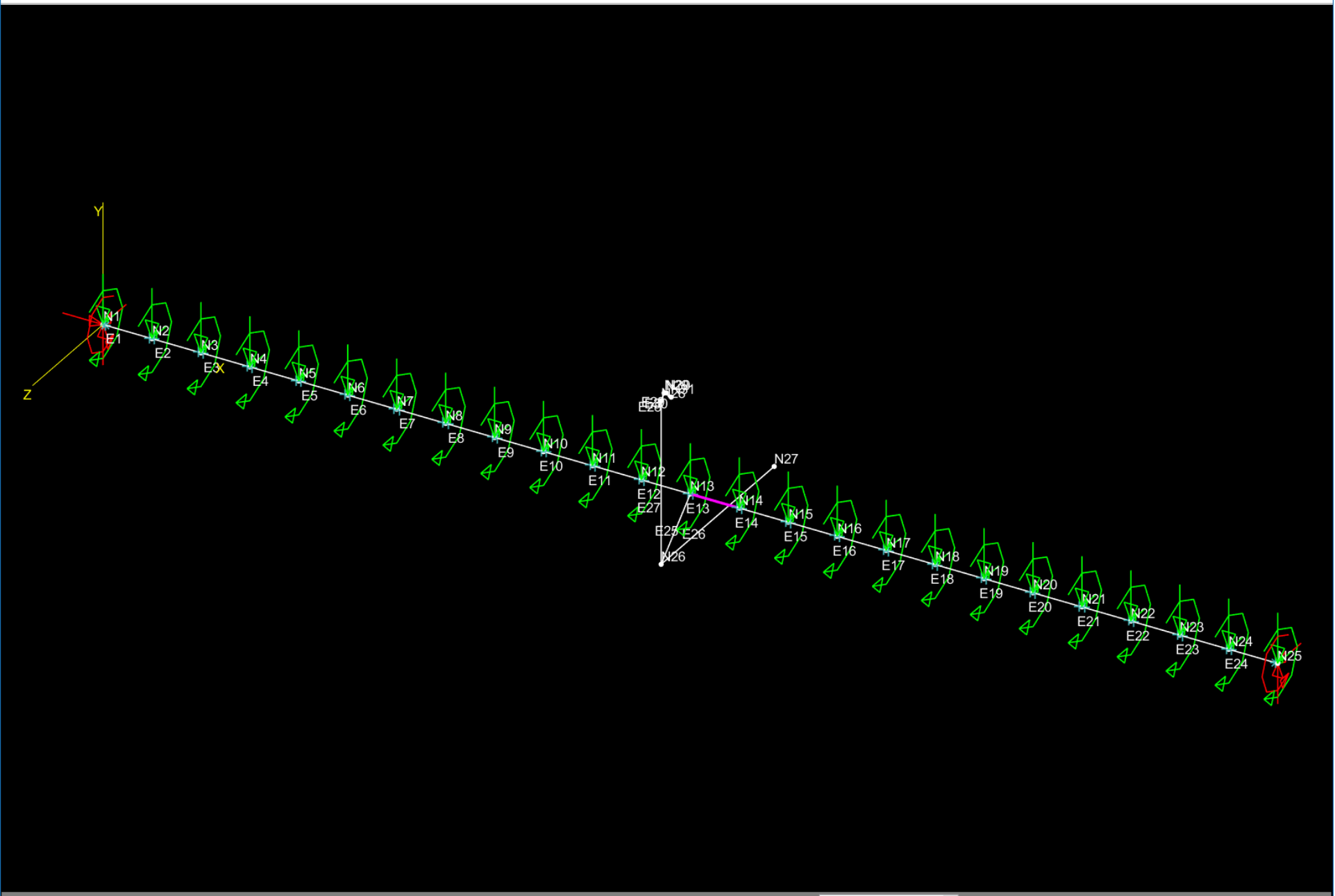

El #	13	N13:N14	P	0.0007581	Vy	-6.202	Vz	2.882	(10) 1.000	Success: El Forces at ALR = 1.0000			
<		>	0.00L	Tx	9.554	My	-825	Mz	1788	B	1373	Apply	Cancel



3) Updating the Geometry -- Scaling

A newer feature of MASTAN2 allows for the length of the model to quickly updated.

- 1) From the **Geometry** menu select **Scale Node(s)**.
- 2) At the bottom menu bar, click in the edit box to the right of **Cx =** and change **1** to **0.5**. This will scale the model only in the x-direction making the overall length of the beam 24 inches.
- 3) Click the **All** button to populate the list of nodes.
- 4) Click on the **Apply** button. 

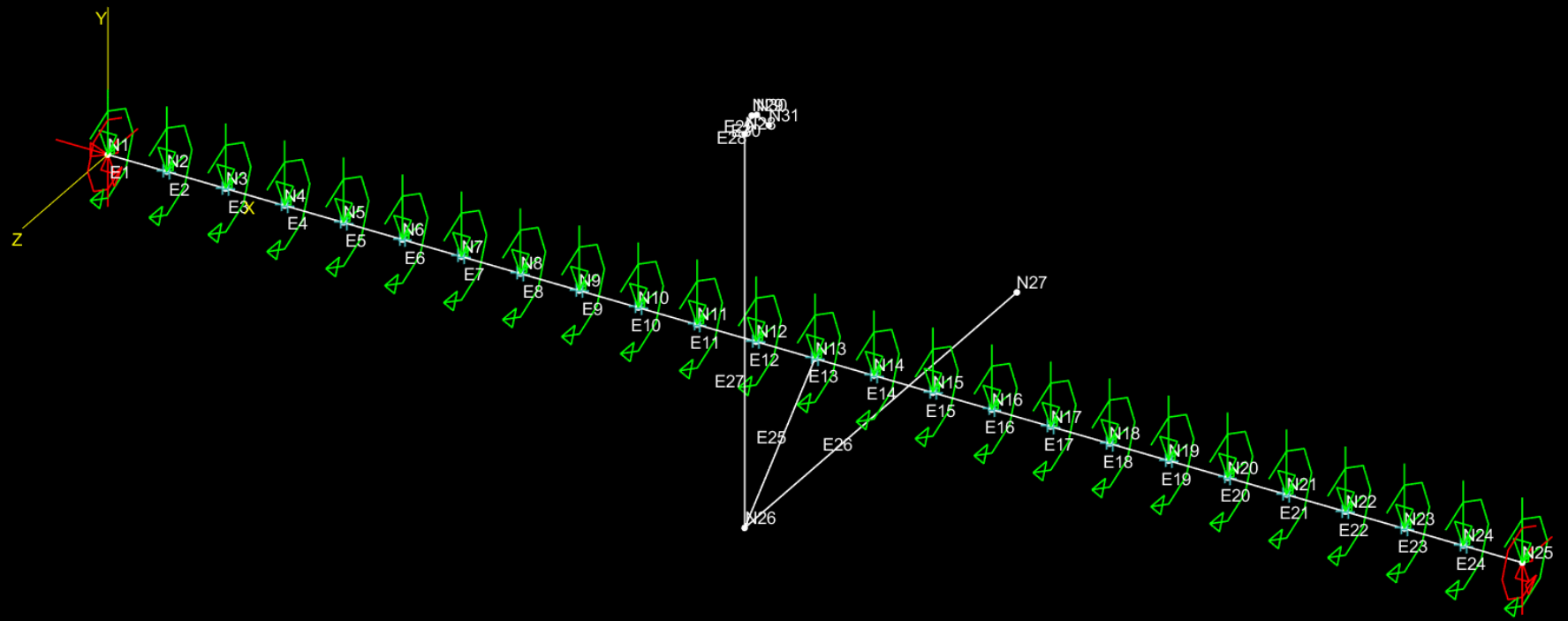

MASTAN2



Define node(s) and scaling input	Node(s):	All	Clr	Adv	Status:	Success: Node(s) Scaled.		
<input checked="" type="radio"/> About point coords:	x =	0	y =	0	z =	0	<input type="radio"/> About node:	N1
Scale factors:	Cx =	0.5	Cy =	1	Cz =	1	Apply	Cancel



3) Updating the Geometry – Update Loading

- 1) From the **Conditions** menu select **Define Forces**.
- 2) At the bottom menu bar, click in the edit box just to the right of **PY =** and change **0** to **-6.17**. Click in the edit box just to the right of **PZ =** and change **0** to **2.95**.
- 3) Click the **Adv** button to open the pop-up menu. To select the main beam nodes, change the edit box to the left of **Z** to **-1**. Change the edit box to the right of **Z** to **1**.
- 4) Click **Add** to add all main beam nodes.
- 5) Click on the **Apply** button. 
- 6) From the **Conditions** menu select **Define Moments**.
- 7) At the bottom menu bar, click in the edit box just to the right of **Mx =** and change **0** to **-8.71**.
- 8) Click the **Adv** button to open the pop-up menu. To select the main beam nodes, change the edit box to the left of **Z** to **-1**. Change the edit box to the right of **Z** to **1**.
- 9) Click **Add** to add all main beam nodes.
- 10) Click on the **Apply** button. 

MASTAN2: C:\Users\SSIRL\Desktop\Pour_Stop.mat

File View Geometry Properties Conditions Analysis Results

Advanced Node Selection

Range (Inclusive)

-Inf	X	Inf
-Inf	Y	Inf
-1	Z	1

Add Remove Reset

Please define node(s) and forces Node(s): 1 2 3 4 5 6 7 8 9 10 11 All Clr Adv Status: Success: Forces at nodes defined.

PX = 0 PY = -6.17 PZ = 2.95 Apply Cancel



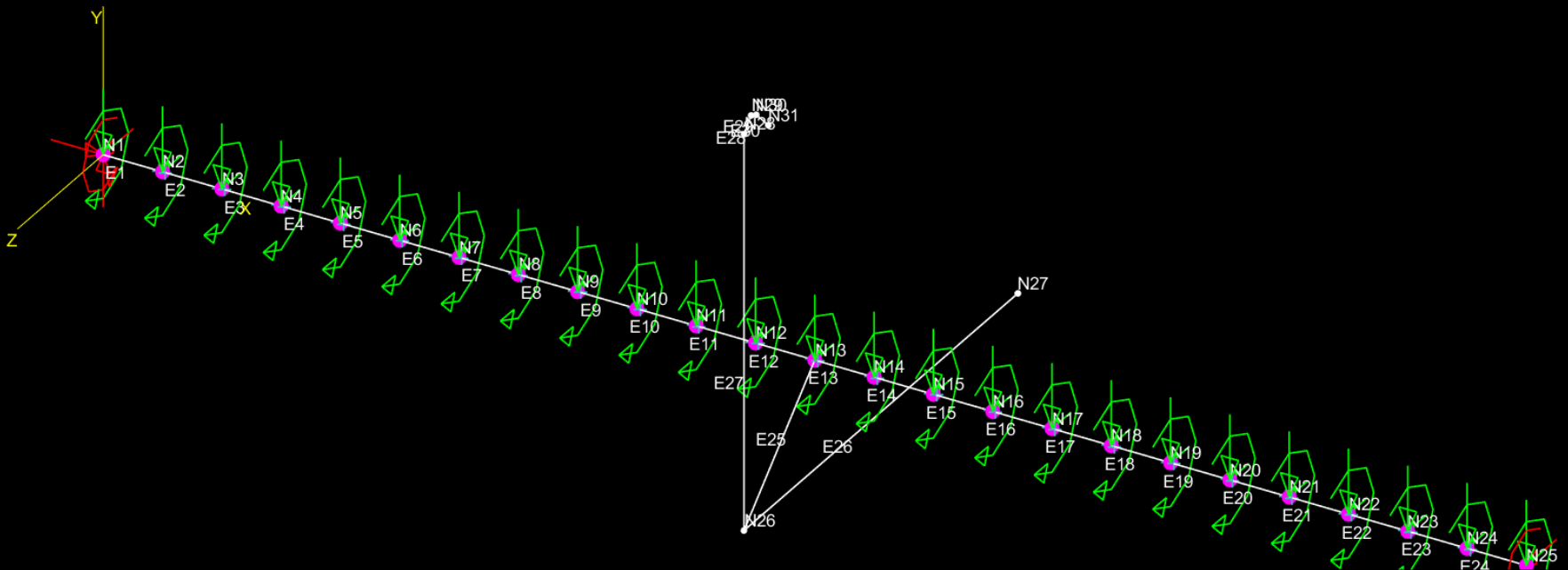

Advanced Node Selection

Range (Inclusive)

-Inf	X	Inf
-Inf	Y	Inf
-1	Z	1

Add Remove Reset

Please define node(s) and moments

Node(s): 1 2 3 4 5 6 7 8 9 10 11 All Clr Adv Status: Success: Moments at nodes defined.

MX = -8.71 MY = 0 MZ = 0 Apply Cancel



3) Updating the Geometry -- 2nd-Order Elastic Analysis

- 1) From the **Analysis** menu select **Static** and submenu option **2nd-Order Elastic**.
- 2) At the bottom menu bar, the **Analysis Type:** should already be set to **Space Frame** as desired.
- 3) Click on the **Apply** button to perform the analysis.
- 4) From the **Results** menu select **Node Displacements**.
- 5) Click on the midspan node of interest, node **13**, and the displacements for base 6 degree of freedoms are provided in the bottom menu bar. 

Results:

Disp X	Disp Y	Disp Z	Rot X	Rot Y	Rot Z
-4.818e-6	-0.007676	-0.005841	-3.356e-3	~0	~0

- 6) From the **Results** menu select **Element Forces**.
- 7) On the undeflected shape, click on the element of interest, element **13**, and the internal forces are provided in the bottom menu bar. These are the forces at the start of the member and the middle of the beam. 



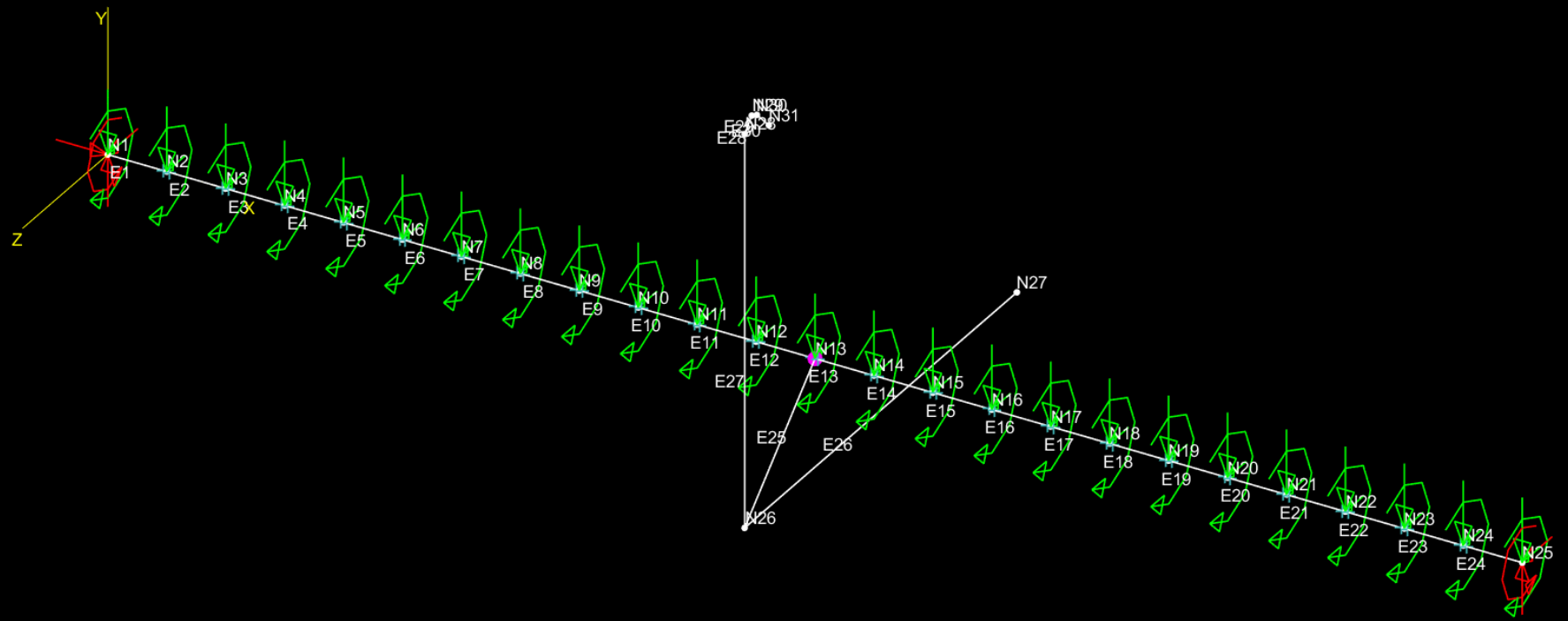

Node:	13	Disp X	-4.818e-06	Disp Y	-0.007676	Disp Z	-0.005841	Status:	Success: Disp. at ALR = 1.0000
Displacements	Rot X	-0.003356	Rot Y	-1.092e-11	Rot Z	-1.236e-11	(10) 1.000	Apply	Cancel



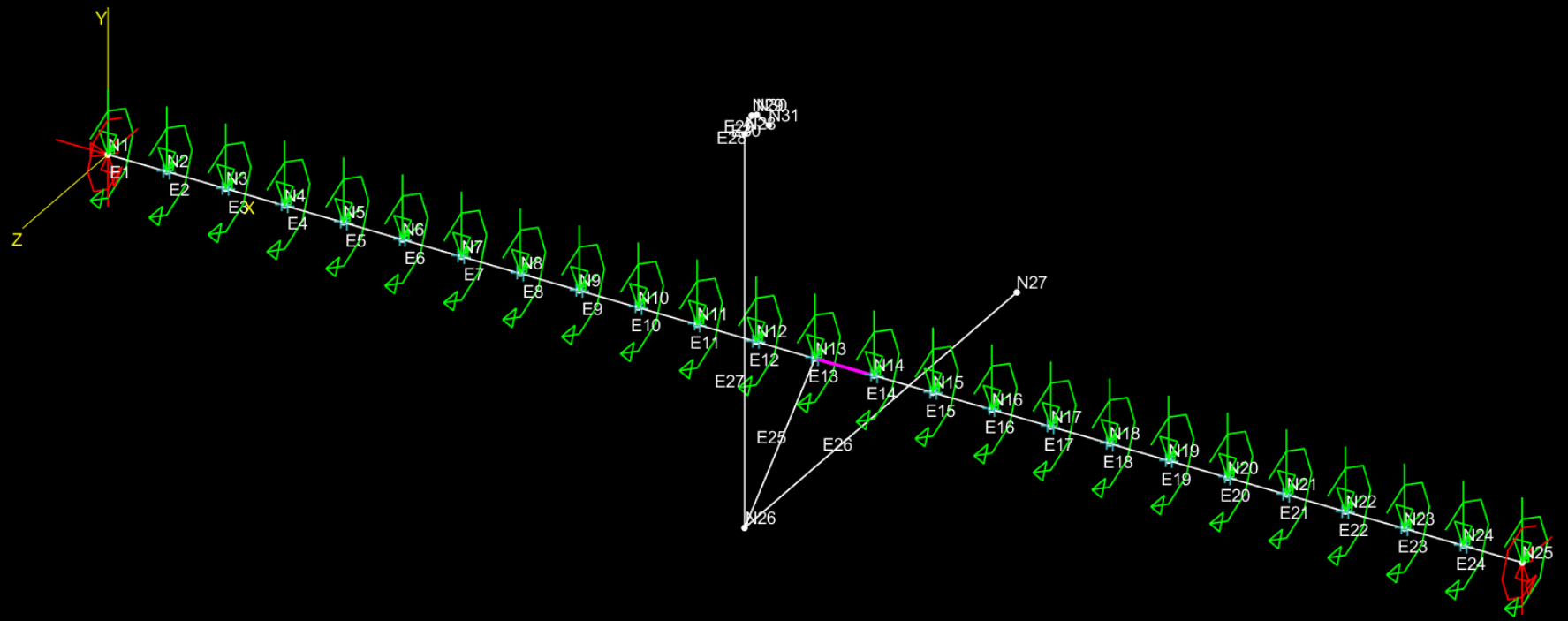

El #	13	N13:N14	P	0.0001255	Vy	-3.09	Vz	1.465	(10) 1.000	Success: El Forces at ALR = 1.0000			
<		>	0.00L	Tx	4.487	My	-210.5	Mz	445.1	B	1019	Apply	Cancel



3) Updating the Geometry -- Additional Sections

If other critical locations for the displacement of the cross section are needed, we can duplicate the existing cross section that was modeled.

- 1) From the **Geometry** menu select **Duplicate Element(s)**.
- 2) At the bottom menu bar, click in the edit box to the right of **Delta x =** and change **0** to **-2**. Ensure the check box next to **Include Attributes** is selected to include the property information is included.
- 3) Click the **Adv** button to open the pop-up menu. Ensure the check box next to **X-axis** is selected.
- 4) To select the illustrated cross section, click **All** next to the **Element(s):** window. Then click the **Remove** button.
- 5) Repeatedly click the **>** button to the right of **Times =** to increase **1** to **5**.
- 6) Click on the **Apply** button. 

The analysis is not run again as the addition of these elements will not change the results. It would just provide more information on the displacement of the cross section.



MASTAN2: C:\Users\SSIRL\Desktop\Pour_Stop.mat

File View Geometry Properties Conditions Analysis Results

Advanced Element Selection

Parallel to: On

X-axis

Y-axis

Z-axis

Range (Inclusive) Off

-Inf	X	Inf
-Inf	Y	Inf
-Inf	Z	Inf

Add Remove Reset

Define element(s) and duplication data Element(s): All Clr Adv Status: Success: Element(s) Duplicated.

Delta x = 0 Delta y = 0 Delta z = 0 Include Attributes Times = < 1 > Apply Cancel



This completes the tutorial.

Tutorial for MASTAN2 v5.1 - Steel Joist

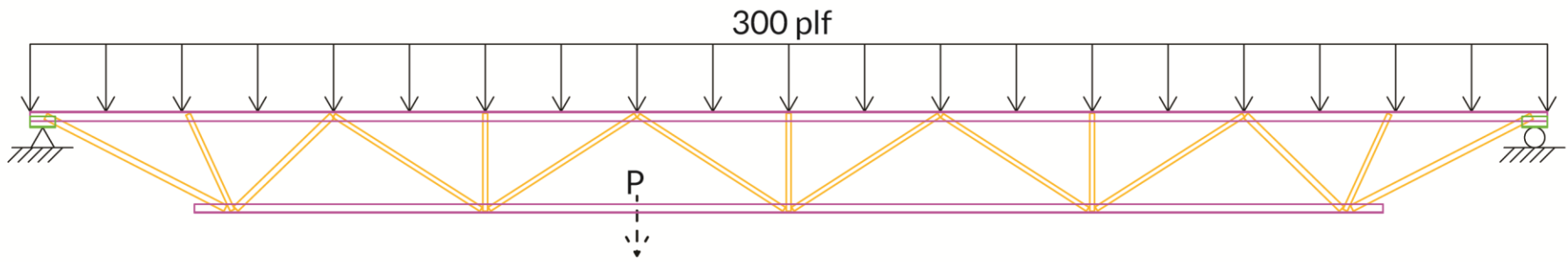

Credits

Published 2020

Developed by:

Edward J. Sippel, Ph.D. Student, University of Wisconsin – Madison

Hannah B. Blum, Assistant Professor, University of Wisconsin - Madison

Ronald D. Ziemian, Professor, Bucknell University

Joe Pote, Director of Research & Development, New Millennium Building Systems

Scott Morton, Research and Development Engineer, New Millennium Building Systems

Sponsored by:

American Iron and Steel Institute

New Millennium Building Systems

Steel Joist Institute

Steel Deck Institute



Tutorial Sections

Section 1: Overview

Section 2: Getting Started

Section 3: Base Joist Geometry

Section 4: Member Properties and Connections

Section 5: Loading and Analysis

Section 6: Hanging Load Analysis

Navigation

 - Skip to Previous Section Title Page

 - Previous Slide

 - Return to Tutorial Sections Page

 - Next Slide

 - Skip to Next Section Title Page

 - Open screenshot of MASTAN2 or additional helpful information.

Section 1: Overview

Overview

This tutorial provides step-by-step guidance for the sample joist structure. Enough details are provided that the example model with non-doubly symmetric sections can be completed following the instructions here. Not every feature available in MASTAN2 will be mentioned nor utilized in this tutorial. For further information on many of the features within MASTAN2 make use of other tutorials at <http://www.mastan2.com/tutorial.html>.



Problem Overview

This tutorial works with a single open-web steel joist. The model will be created to show how to analyze a joist for a uniform distributed load on the top chord accounting for the non-doubly symmetric section properties. This model will then be adjusted to allow for the application of an eccentric point load on the bottom chord. Further details of each model will be provided in the corresponding section.

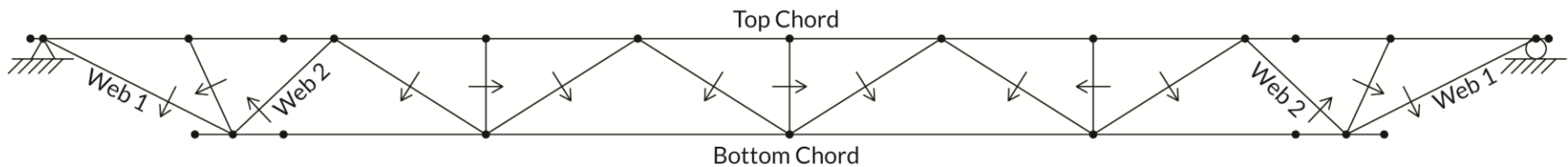
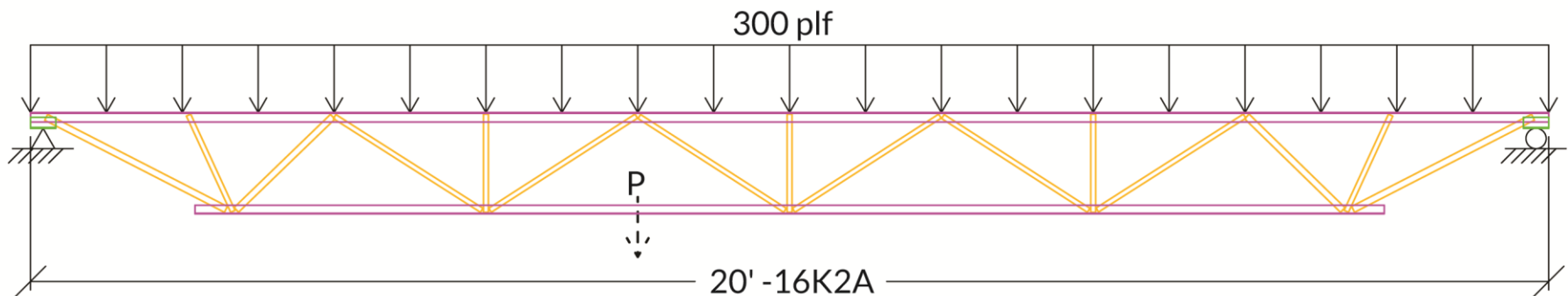

Arrows indicate the open side of the web channels. Web members not otherwise labeled are Web 3



Section 2: Getting Started

MASTAN2 General Information

MASTAN2 is an interactive graphics program that provides preprocessing, analysis, and postprocessing capabilities. Preprocessing options include definition of structural geometry, support conditions, applied loads, and element properties. The analysis routines provide the user the opportunity to perform first- or second-order elastic or inelastic analyses of two- or three-dimensional frames and trusses subjected to static and dynamic loads. Postprocessing capabilities include the interpretation of structural behavior through deformation and force diagrams, printed output, and facilities for plotting response curves. MASTAN2 is based on MATLAB®, a premier software package for numeric computing and data analysis.

In many ways, MASTAN2 is similar to today's commercially available software in functionality. The number of pre- and post-processing options, however, have been limited in order to minimize the amount of time needed for a user to become proficient at its use. The program's linear and nonlinear analysis routines are based on the theoretical and numerical formulations presented in the text *Matrix Structural Analysis, 2nd Edition*, by McGuire, Gallagher, and Ziemian. In this regard, the reader is strongly encouraged to use this software as a tool for demonstration, reviewing examples, solving problems, and perhaps performing analysis and design studies. Where MASTAN2 has been written in modular format, the reader is also provided the opportunity to develop and implement additional or alternative analysis routines directly within the program.

MATLAB is a registered trademark of The MathWorks, Inc., 3 Apple Hill Drive, Natick, MA 01760-2098.



Launching MASTAN2

Two versions of MASTAN2 have been developed and may be installed. One requires you to have access to MATLAB and the other does not. Both versions provide the same functionality, except that the MATLAB version also provides the user an opportunity to develop and implement additional or alternative analysis routines that will directly interact with MASTAN2. Please see the Setup Guides at www.mastan2.com.

MASTAN2 v3.5

Home
About
FAQ's
Screenshots
Tutorial
Stability Fun
Textbook
Download
Contact

Designed By
Projectdesigns.org
XHTML 1.0 Strict

Overview
MASTAN2 is an interactive structural analysis program that provides preprocessing, analysis, and postprocessing capabilities.

- Preprocessing
- Analysis
- Postprocessing

Preprocessing
Preprocessing options include definition of structural geometry, support conditions, applied loads, and element properties.

Analysis
The analysis routines provide the user the opportunity to perform first- or second-order elastic or inelastic analyses of two- or three-dimensional frames and trusses subjected to static loads.

Postprocessing
Postprocessing capabilities include the interpretation of structural behavior through deformation and force diagrams, printed output, and facilities for plotting response curves.

Start Here



Base Layout

In order to minimize the learning time for MASTAN2, its graphical user interface (GUI) has been designed using a simple and consistent two menu approach. Using a pull-down menu at the top of the GUI, a command is selected. Parameters are then defined in the bottom menu bar and the command is executed by using the Apply button.

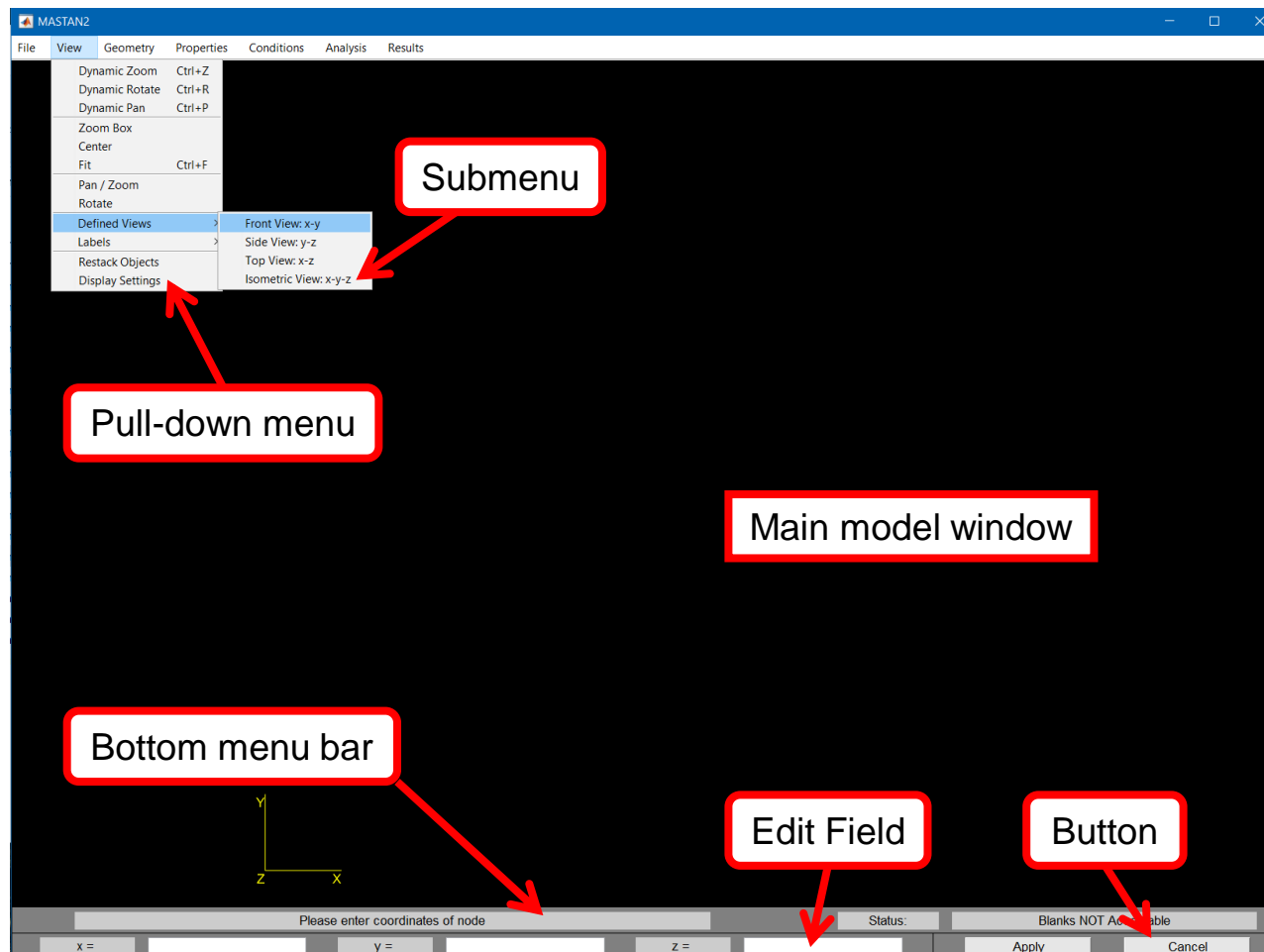

Section 3: Base Joist Geometry

Naming and Saving

While you can build the model and complete the analysis without saving or applying a title, due to the complexity of the model we will create a save file immediately. For the remainder of this tutorial, there will not be a reminder to save. However, it can be useful to save the file as you go along, particularly before any action that is not easily reversed as there is no undo feature. A file can be reopened while still working in that file without saving it to revert to the previous save version of the model that is unaffected by your last steps.

- 1) Start with a new, empty model.
- 2) From the **File** menu select **Define title**. At the bottom menu bar, click in the edit box to the right of **Title:** and type in a brief description of this effort. This text might include the model title, your name, and/or the assignment number. Click on the **Apply** button.
- 3) From the **File** menu select **Save As ...**. After selecting your destination folder, type in the filename **Joist** and click **Save**. Note that the top of the window has now changed to include the file name and directory as well as the time the file was last saved. 



MASTAN2: C:\Users\SSIRL\Desktop\Joist.mat [16:23]

File View Geometry Properties Conditions Analysis Results



Please enter title and select apply

Status: Success: Title defined.

Title: Joist

Apply Cancel



Defining the Joist

The joist will be modeled with the chords as two separate members to allow them to twist independently. The geometry could be input by defining individual nodes and then individual elements or making use of the extrude element tool extensively. Instead, the **Input Geometry** tool will be used to define most of the joist geometry. As a large part of creating the frame is the prep work, an explanation of what values were used is provided on this page and the next pages explain how to use the values and links to what the values are.

The joist was defined as a series of nodes along the top chord and then the bottom chord. The first set is for the chords set back in the negative z-direction. The second set is for the chords in the positive z-direction. The third set is on the x-y plane for member to member connections and the webs. The x position was defined based on the simple joist geometry. 

A node is defined for the end of the members, each web intersection, and where the joist bracing connects. The y position of the top chord nodes is set as 16" minus the centroid of the top chord angle while the bottom chord is 0" plus the centroid of the bottom chord angle. The z position similarly accounts for the centroid position plus a 1-1/8" gap between the chords. 

The elements are defined in order to connect all back chords, all front chords, all webs, and then the connections in between.



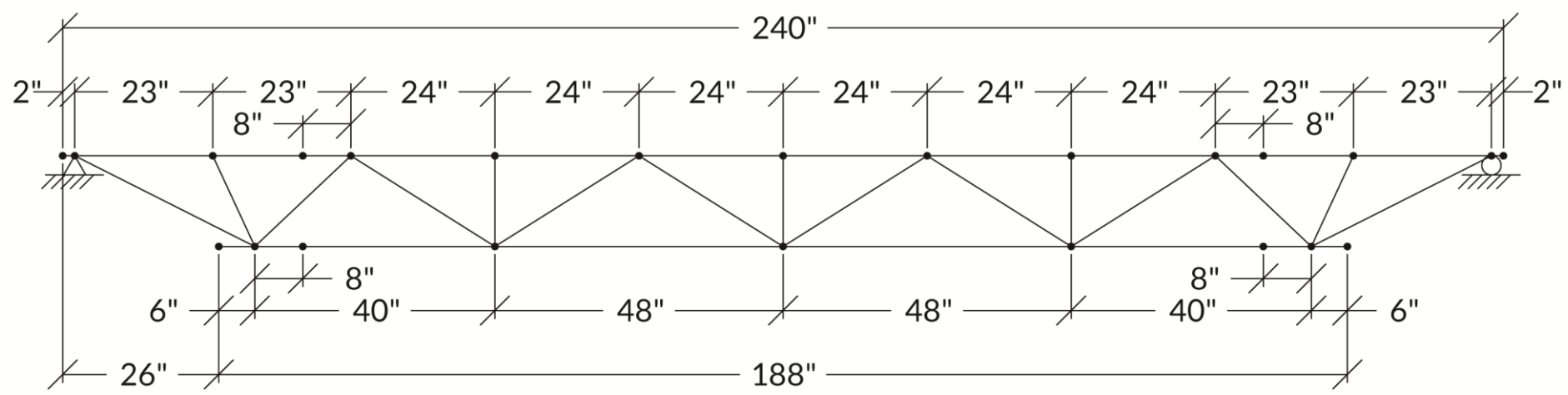
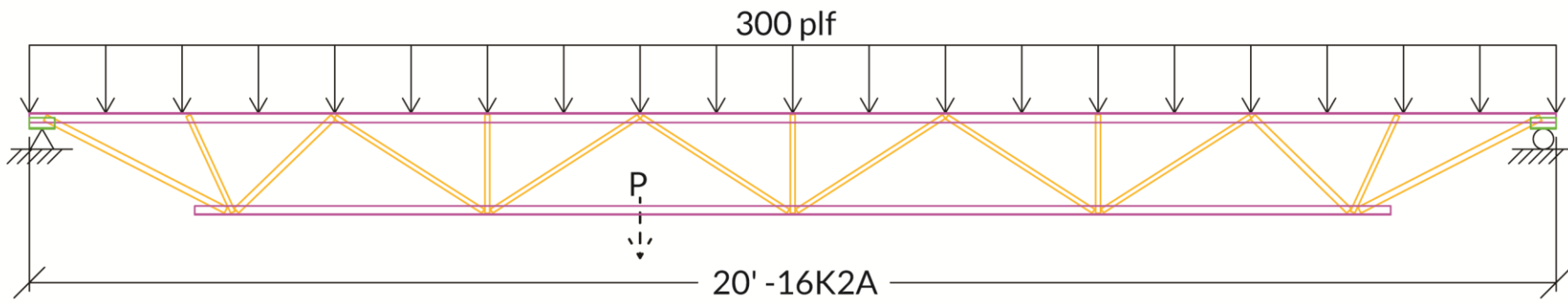

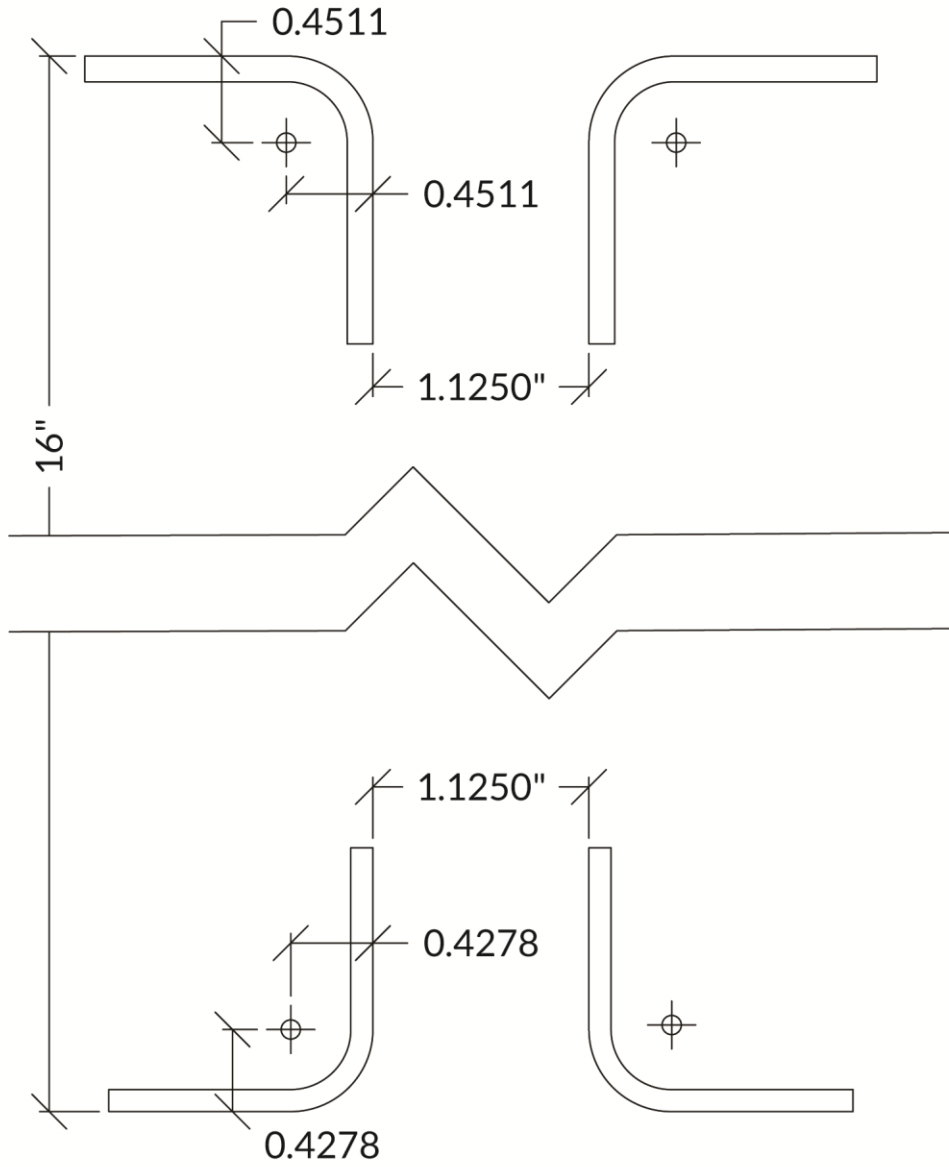

Defining Geometry

For entering the node coordinates and element information below, the values are provided in two different formats for your use. Node and element information needs to be copied only once.

A - Lists all the node information in separate readable segments to be copied in order. 

B - Lists all the element information in separate readable segments to be copied in order. 

C - Lists all the node and then all element information in small font lists to be copied all at once. 

- 1) From the **Geometry** menu select **Input Geometry** .
- 2) At the bottom menu bar, **Nodes** should be already selected. In the edit box to the right of **X_coord Y_coord Z_coord**, enter manually or copy and paste the coordinate values.
- 3) Click on **Nodes** to open a pop-up menu. Click on **Elements** to update what information is imported.
- 4) In the edit box to the right of **Node_i Node_j Beta(deg)**, enter manually or copy and paste the element start and end nodes. When only 2 values are provided, beta is assumed to be 0.
- 5) Click on the **Apply** button. 

Note: **Apply** button could be clicked before defining the **Element** list to just input the **Nodes** first. The **Element** list will then use the existing node information on the second use of **Apply** button.



Copy all 3 tables in order

Nodes 1

0	15.54894	-1.01356
2	15.54894	-1.01356
25	15.54894	-1.01356
40	15.54894	-1.01356
48	15.54894	-1.01356
72	15.54894	-1.01356
96	15.54894	-1.01356
120	15.54894	-1.01356
144	15.54894	-1.01356
168	15.54894	-1.01356
192	15.54894	-1.01356
200	15.54894	-1.01356
215	15.54894	-1.01356
238	15.54894	-1.01356
240	15.54894	-1.01356
26	0.42775	-0.99025
32	0.42775	-0.99025
40	0.42775	-0.99025
72	0.42775	-0.99025
120	0.42775	-0.99025
168	0.42775	-0.99025
200	0.42775	-0.99025
208	0.42775	-0.99025
214	0.42775	-0.99025

Nodes 2

0	15.54894	1.01356
2	15.54894	1.01356
25	15.54894	1.01356
40	15.54894	1.01356
48	15.54894	1.01356
72	15.54894	1.01356
96	15.54894	1.01356
120	15.54894	1.01356
144	15.54894	1.01356
168	15.54894	1.01356
192	15.54894	1.01356
200	15.54894	1.01356
215	15.54894	1.01356
238	15.54894	1.01356
240	15.54894	1.01356
26	0.42775	0.99025
32	0.42775	0.99025
40	0.42775	0.99025
72	0.42775	0.99025
120	0.42775	0.99025
168	0.42775	0.99025
200	0.42775	0.99025
208	0.42775	0.99025
214	0.42775	0.99025

Nodes 3

0	15.54894	0
2	15.54894	0
25	15.54894	0
40	15.54894	0
48	15.54894	0
72	15.54894	0
96	15.54894	0
120	15.54894	0
144	15.54894	0
168	15.54894	0
192	15.54894	0
200	15.54894	0
215	15.54894	0
238	15.54894	0
240	15.54894	0
26	0.42775	0
32	0.42775	0
40	0.42775	0
72	0.42775	0
120	0.42775	0
168	0.42775	0
200	0.42775	0
208	0.42775	0
214	0.42775	0



Copy all 5 tables in order

1 B. Chord

1	2
2	3
3	4
4	5
5	6
6	7
7	8
8	9
9	10
10	11
11	12
12	13
13	14
14	15
16	17
17	18
18	19
19	20
20	21
21	22
22	23
23	24

2 F. Chord

25	26
26	27
27	28
28	29
29	30
30	31
31	32
32	33
33	34
34	35
35	36
36	37
37	38
38	39
40	41
41	42
42	43
43	44
44	45
45	46
46	47
47	48

3 Webs

50	65
51	65
53	65
53	67
54	67
55	67
55	68
56	68
57	68
57	69
58	69
59	69
59	71
61	71
62	71

4 B. Conn.

50	2
51	3
53	5
54	6
55	7
56	8
57	9
58	10
59	11
61	13
62	14
65	17
67	19
68	20
69	21
71	23

5 F. Conn.

50	26
51	27
53	29
54	30
55	31
56	32
57	33
58	34
59	35
61	37
62	38
65	41
67	43
68	44
69	45
71	47



Copy all values to the **Node** section

Nodes

0	15.54894	-1.01356
2	15.54894	-1.01356
25	15.54894	-1.01356
40	15.54894	-1.01356
48	15.54894	-1.01356
72	15.54894	-1.01356
96	15.54894	-1.01356
120	15.54894	-1.01356
144	15.54894	-1.01356
168	15.54894	-1.01356
192	15.54894	-1.01356
200	15.54894	-1.01356
215	15.54894	-1.01356
238	15.54894	-1.01356
240	15.54894	-1.01356
26	0.42775	-0.99025
32	0.42775	-0.99025
40	0.42775	-0.99025
72	0.42775	-0.99025
120	0.42775	-0.99025
168	0.42775	-0.99025
200	0.42775	-0.99025
208	0.42775	-0.99025
214	0.42775	-0.99025
0	15.54894	1.01356
2	15.54894	1.01356
25	15.54894	1.01356
40	15.54894	1.01356
48	15.54894	1.01356
72	15.54894	1.01356
96	15.54894	1.01356
120	15.54894	1.01356
144	15.54894	1.01356
168	15.54894	1.01356
192	15.54894	1.01356
200	15.54894	1.01356
215	15.54894	1.01356
238	15.54894	1.01356
240	15.54894	1.01356
26	0.42775	0.99025
32	0.42775	0.99025
40	0.42775	0.99025
72	0.42775	0.99025
120	0.42775	0.99025
168	0.42775	0.99025
200	0.42775	0.99025
208	0.42775	0.99025
214	0.42775	0.99025
0	15.54894	0
2	15.54894	0
25	15.54894	0
40	15.54894	0
48	15.54894	0
72	15.54894	0
96	15.54894	0
120	15.54894	0
144	15.54894	0
168	15.54894	0
192	15.54894	0
200	15.54894	0
215	15.54894	0
238	15.54894	0
240	15.54894	0
26	0.42775	0
32	0.42775	0
40	0.42775	0
72	0.42775	0
120	0.42775	0
168	0.42775	0
200	0.42775	0
208	0.42775	0
214	0.42775	0

Copy all values to the **Element** section

Elements

1	2
2	3
3	4
4	5
5	6
6	7
7	8
8	9
9	10
10	11
11	12
12	13
13	14
14	15
16	17
17	18
18	19
19	20
20	21
21	22
22	23
23	24
25	26
26	27
27	28
28	29
29	30
30	31
31	32
32	33
33	34
34	35
35	36
36	37
37	38
38	39
40	41
41	42
42	43
43	44
44	45
45	46
46	47
47	48
50	65
51	65
53	65
53	67
54	67
55	67
55	68
56	68
57	68
57	69
58	69
59	69
59	71
61	71
62	71
50	2
51	3
53	5
54	6
55	7
56	8
57	9
58	10
59	11
61	13
62	14
65	17
67	19
68	20
69	21
71	23
50	26
51	27
53	29
54	30
55	31
56	32
57	33
58	34
59	35
61	37
62	38
65	41
67	43
68	44
69	45
71	47



MASTAN2

MASTAN2: C:\Users\SSIRL\Desktop\Joist.mat

File View Geometry Properties Conditions Analysis Results





Elements ▾ Enter each element's data as 3 values separated by spaces per row (perhaps using paste) Status: Success: All geometry added.

Node_i	Node_j	Beta(deg)

Apply Cancel



Lower Bridging Support

- 1) From the **Geometry** menu select **Extrude Element**.
- 2) Click on the nodes on the bottom chord closest to the joist bridging connection: Nodes **18, 22, 42,** and **46** to populate the nodes to be extruded.  
- 3) Click in the edit box to the right of **Delta y =** and change **0** to **2.5**.
- 4) Click on the **Apply** Button. 
- 5) Click on the new nodes above the back, bottom chord to the joist bridging. Depending on the exact order you clicked the previous nodes, the node index may vary.
- 6) Click in the edit box to the right of **Delta z =** and change **0** to **0.99025**. Increase the **Times =** from **1** to **2** by clicking on the **>** button.
- 7) Click on the **Apply** Button. 

Note: The elements created in Step 2 will need to be manually selected multiple times through this project. These 4 elements will be referenced as the vertical braces after this point.



MASTAN2: C:\Users\SSIRL\Desktop\Joist2.mat [09:36]

File View Geometry Properties Conditions Analysis Results

Define node(s) and data to extrude elements(s)

Node(s):	18 42	All	Clr	Adv	Status:	Blanks NOT Acceptable					
Delta x =	0	Delta y =	0	Delta z =	0	Beta (deg)	0	Times =	< 1 >	Apply	Cancel



MASTAN2

MASTAN2: C:\Users\SSIRL\Desktop\Joist2.mat [09:36]

File View Geometry Properties Conditions Analysis Results

Define node(s) and data to extrude elements(s) Node(s): 18 42 22 46 All Clr Adv Status: Blanks NOT Acceptable

Delta x = 0 Delta y = 0 Delta z = 0 Beta (deg) 0 Times = < 1 > Apply Cancel



MASTAN2

MASTAN2: C:\Users\SSIRL\Desktop\Joist.mat

File View Geometry Properties Conditions Analysis Results

Define node(s) and data to extrude element(s) Node(s): All Clr Adv Status: Success: Element(s) Extruded.

Delta x = 0 Delta y = 0 Delta z = 0 Beta (deg) 0 Times = < 1 > Apply Cancel



MASTAN2

MASTAN2: C:\Users\SSIRL\Desktop\Joist.mat



File View Geometry Properties Conditions Analysis Results

Define node(s) and data to extrude element(s) Node(s): All Clr Adv Status: Success: Element(s) Extruded.

Delta x = 0 Delta y = 0 Delta z = 0 Beta (deg) 0 Times = < 1 > Apply Cancel



Top Chord Meshing

- 1) From the **Geometry** menu select **Subdivide Element(s)**. The top chord is to be meshed into approximately 8" segments.
- 2) Click on the 4 top chord sections near the cross-bracing support to be subdivided 2 times. 
- 3) Click on the **Apply** button.
- 4) Click the **>** box to the right of **# of Segments =** to increase **2** to **3**.
- 5) In the bottom menu bar, use the buttons to the right of **Element(s):** to make the list of elements to be subdivided 3 times.
- 6) Click the **Adv** button to open pop-up menu. To select middle of the top chords, click the check box next to the **X-axis** option. Ensure the button to the right of **Range (Inclusive)** to change **Off** to **On**. Change the edit box to the left of **X** from **-Inf** to **48**. Change the edit box to the right of **X** from **Inf** to **192**. Change the edit box to the left of **Y** from **-Inf** to **8**. Click **Add** to select.
- 7) Click on the 4 remaining exterior top chord sections to be subdivided 3 times. 
- 8) Click on the **Apply** button.



MASTAN2

MASTAN2: C:\Users\SSIRL\Desktop\Joist.mat

File View Geometry Properties Conditions Analysis Results

Please select element(s) and number of segments

Status:

Element(s): 25 3 34 12 All Clr Adv # of Segments = < 2 > Apply Cancel



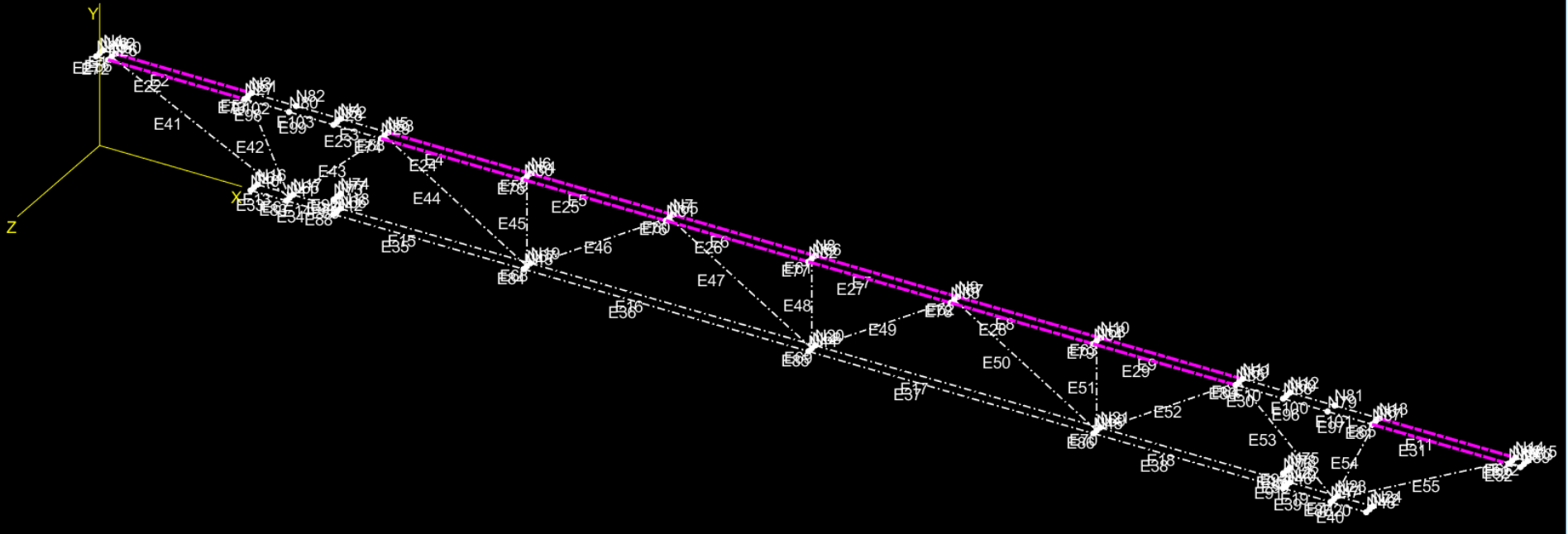

Advanced Element Selection

Parallel to: On

X-axis

Y-axis

Z-axis

Range (Inclusive) On

48	X	192
8	Y	Inf
-Inf	Z	Inf

Add Remove Reset



Please select element(s) and number of segments

Status:

Element(s): 4 5 6 7 8 9 24 25 26 27 28 29 11 31 2 22 All Clr Adv # of Segments = < 3 > Apply Cancel



Bottom Chord Meshing

- 1) The bottom chord is to be meshed into approximately 4" segments.
- 2) Click on the 4-32" long bottom chord elements. 
- 3) Click the > box to the right of **# of Segments =** to increase **3** to **4**.
- 4) Click on the **Apply** button.
- 5) Click on the middle 4 bottom chord elements. 
- 6) Click the > box to the right of **# of Segments =** to increase **4** to **6**.
- 7) Click on the **Apply** button.
- 8) On the **Advanced Element Selection** pop-up, click the **Reset** button. Click the check box next to the **X-axis** option. Click the button to the right of **Range (Inclusive)** to change **Off** to **On**. Change the edit box to the right of **Y** from **Inf** to **8**. Click **Add** to select the entire bottom chord.
- 9) Click the < box to the left of **# of Segments =** to decrease **6** to **2**.
- 10) Click on the **Apply** button. 



MASTAN2: C:\Users\SSIRL\Desktop\Joist.mat

File View Geometry Properties Conditions Analysis Results

Advanced Element Selection

Parallel to:	<input type="checkbox"/> On	Range (Inclusive)		<input type="checkbox"/> On
<input checked="" type="checkbox"/> X-axis		48	X	192
<input type="checkbox"/> Y-axis		8	Y	Inf
<input type="checkbox"/> Z-axis		-Inf	Z	Inf
<input type="button" value="Add"/>		<input type="button" value="Remove"/>		<input type="button" value="Reset"/>

Please select element(s) and number of segments

Status: Success: Element(s) subdivided.

Element(s):	19 7 22 10	All	Clr	Adv	# of Segments =	<	3	>	<input type="button" value="Apply"/>	<input type="button" value="Cancel"/>
-------------	------------	-----	-----	-----	-----------------	---	---	---	--------------------------------------	---------------------------------------



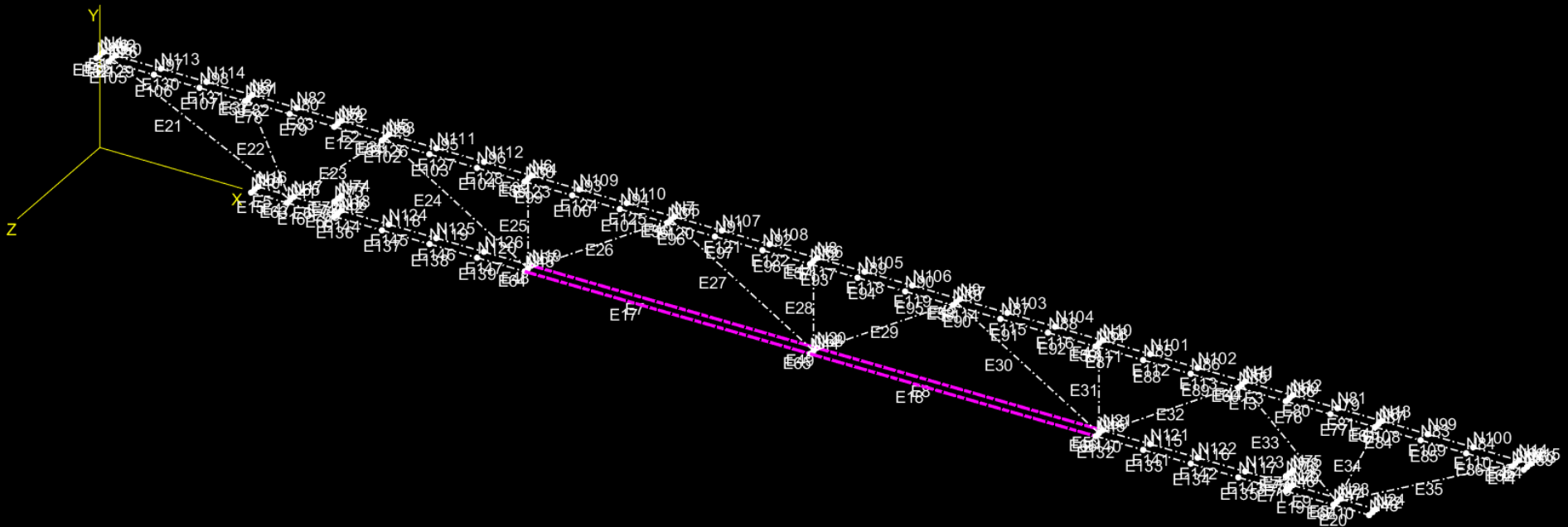

Advanced Element Selection

Parallel to: On

X-axis

Y-axis

Z-axis

Range (Inclusive)		<input type="checkbox"/> On
48	X	192
8	Y	Inf
-Inf	Z	Inf

Add Remove Reset

Please select element(s) and number of segments

Status:

Success: Element(s) subdivided.

Element(s):

17 7 18 8

All

Clr

Adv

of Segments =

<

4

>

Apply

Cancel



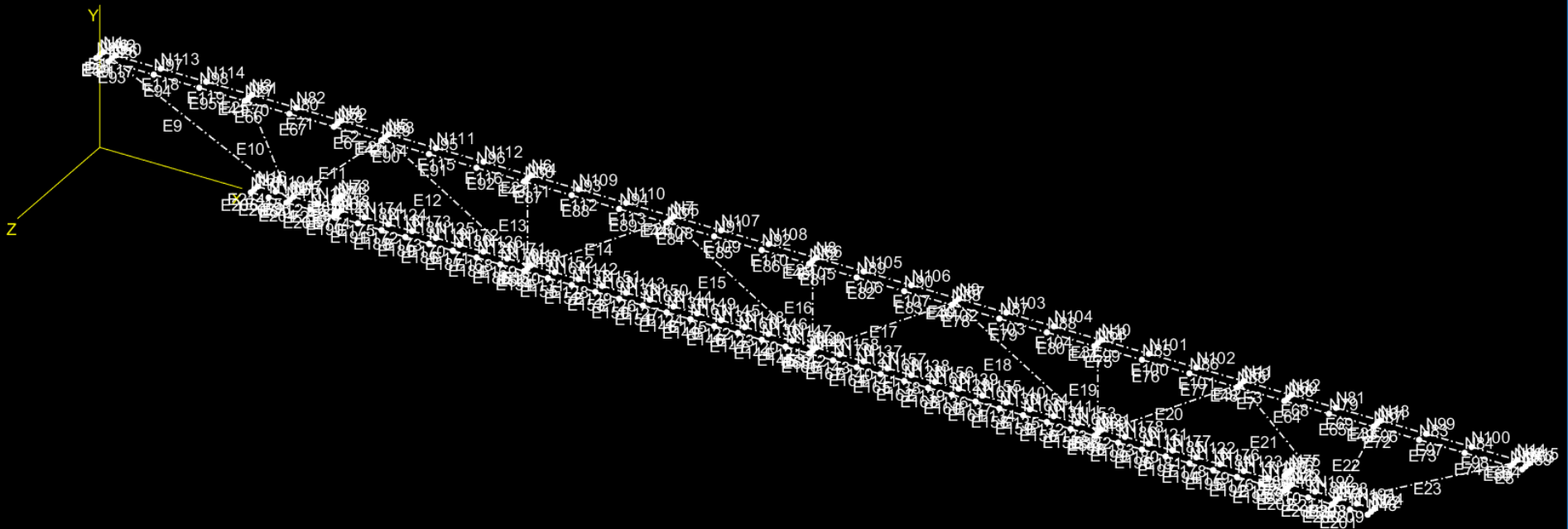

Advanced Element Selection

Parallel to: On

X-axis Y-axis Z-axis

Range (Inclusive) On

-inf	X	+inf
-inf	Y	8
-inf	Z	+inf

Add Remove Reset

Please select element(s) and number of segments

Status:

Success: Element(s) subdivided.

Element(s):

All

Clr

Adv

of Segments =

<

2

>

Apply

Cancel



Web Meshing

- 1) The web is to be meshed into 4 equal segments.
- 2) Click the **>** box to the right of **# of Segments =** to increase **2** to **4**.
- 3) On the **Advanced Element Selection** pop-up, click the **Reset** button. Click the button to the right of **Range (Inclusive)** to change **Off** to **On**. Change the edit box to the left of **Z** from **-Inf** to **-0.1** and to the right of **Z** from **Inf** to **0.1**. Click **Add** to select all webs.
- 4) Click on the **Apply** button. 



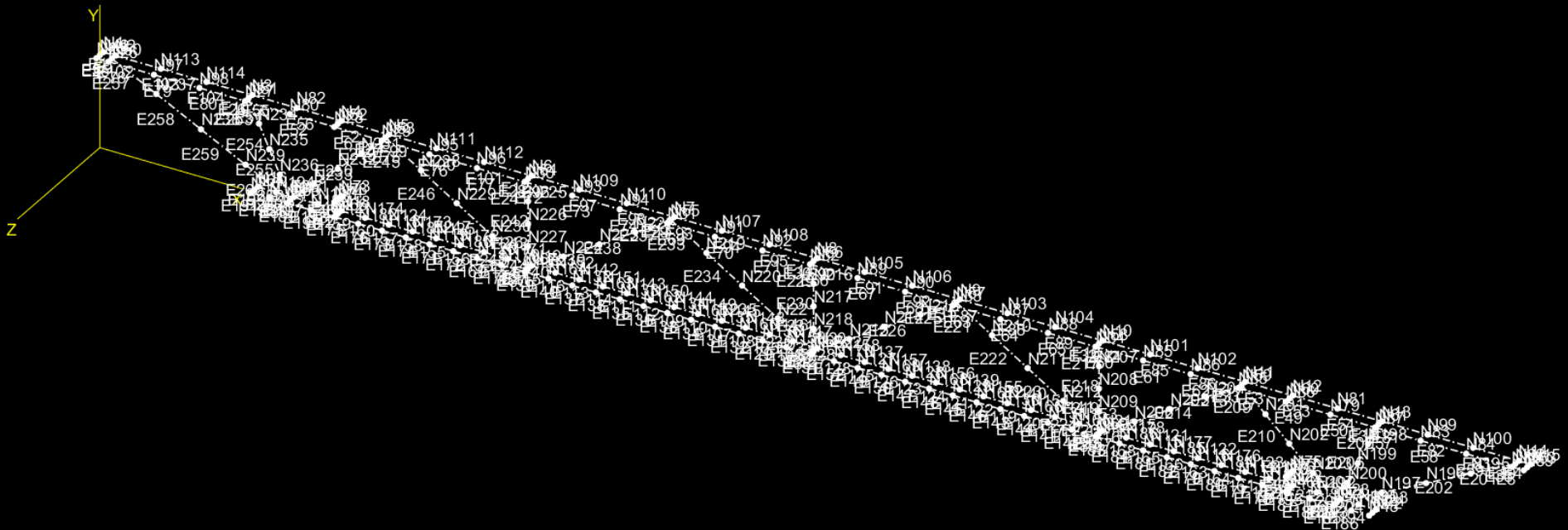

Advanced Element Selection

Parallel to:	<input checked="" type="checkbox"/> On	Range (Inclusive)		<input checked="" type="checkbox"/> On
<input type="checkbox"/> X-axis		-inf	X	+inf
<input type="checkbox"/> Y-axis		-inf	Y	+inf
<input type="checkbox"/> Z-axis		-0.1	Z	0.1
Add		Remove		Reset

Please select element(s) and number of segments Status: Success: Element(s) subdivided.

Element(s): All Clr Adv # of Segments = < 4 > Apply Cancel



Model Cleanup

- 1) From the **Geometry** menu select **Remove Node(s)**.
- 2) Click on **All Unattached** to select all unconnected nodes that were included for simplicity in the initial model construction. 
- 3) Click on the **Apply** button to remove.

The next steps are not required; however, it will help make it easier to find results in the model.

- 4) From the **Geometry** menu select **Renumber Elements**.
- 5) Click the checkbox to the left of **Y-X-Z (2D)**. Click on the **Apply** button.
- 6) From the **Geometry** menu select **Renumber Nodes**.
- 7) Click the checkbox to the left of **Y-X-Z (2D)**. Click on the **Apply** button. 



MASTAN2: C:\Users\SSIRL\Desktop\Joist.mat [16:45]

File View Geometry Properties Conditions Analysis Results

Please define node(s) to remove that are element independent		Status:	
Node(s):	49 52 60 63 64 66 70 72	All Unattached	Clr Adv
		Apply	Cancel



MASTAN2

MASTAN2: C:\Users\SSIRL\Desktop\Joist.mat [16:45]

File View Geometry Properties Conditions Analysis Results

Please define direction sequence for renumbering nodes



Status: Complete: Bandwidth Decreased.

X-Y-Z (2D) X-Z-Y Y-X-Z (2D) Y-Z-X Z-X-Y Z-Y-X Random

Apply Cancel



Eccentric Loading Location

- 1) From the **Geometry** menu select **Extrude Element**.
- 2) Click on the node at the middle of the bottom chord where the loading is to be applied. If you renumbered the model, this should be **Node 167**. 
- 3) Click in the edit box to the right of **Delta z =** and change **0** to **1.5** to define the offset loading location.
- 4) Click on the **Apply** Button. 

MASTAN2: C:\Users\SSIRL\Desktop\Joist2.mat [09:40]

File View Geometry Properties Conditions Analysis Results

Define node(s) and data to extrude element(s)		Node(s):	167	All	Clr	Adv	Status:	Blanks NOT Acceptable	
Delta x =	0	Delta y =	0	Delta z =	0	Beta (deg)	0	Times =	< 1 >
								Apply	Cancel



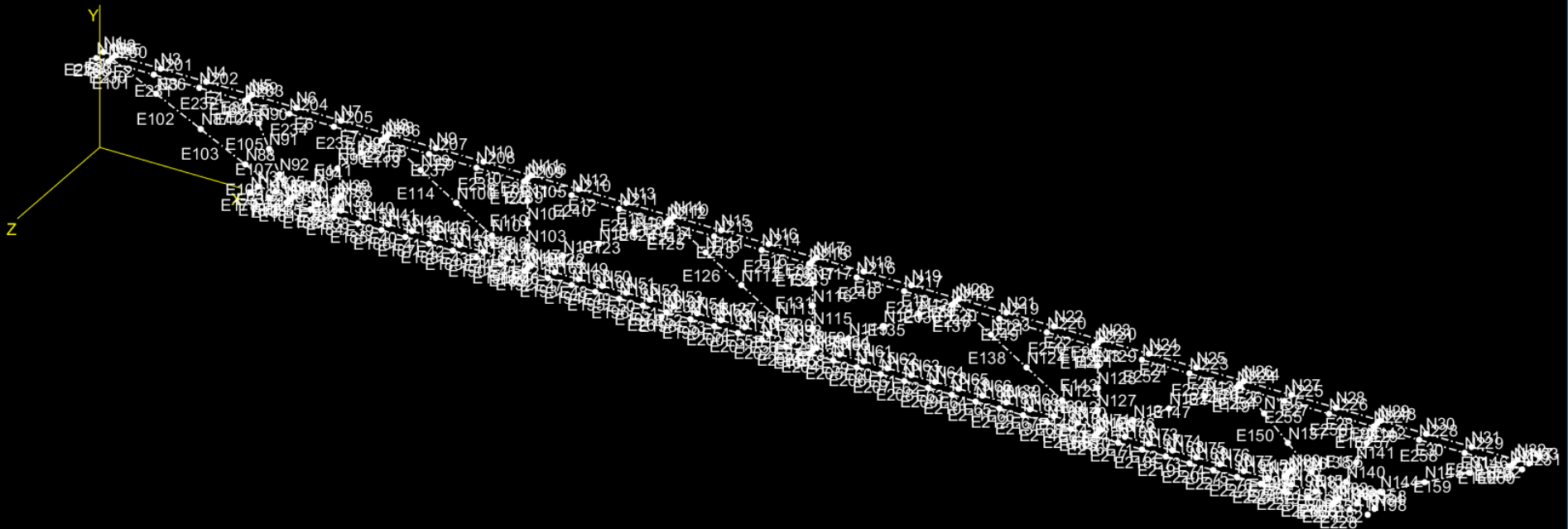

Define node(s) and data to extrude element(s)		Node(s):	All	Clr	Adv	Status:	Success: Element(s) Extruded.
Delta x =	0	Delta y =	0	Delta z =	0	Beta (deg)	0
Times =	<	1	>	Apply	Cancel		



Section 4: Member Properties and Connections

Section Properties

The steel joist model uses 6 sections. There is a separate entry for the top chord angle, the bottom chord angle, the three different web members, and a rigid link connector. 

The information can be input by 3 methods. If the section properties are all previously calculated, values can be entered directly. The information can be input individually via the **Define Section** command after switching to the **Advanced** section properties interface or can be imported as a group via the **Input Properties** command. If the section properties need to be calculated, **MSASect** can be used calculate the information.

This tutorial will first import all the section property information via the **Input Properties** command. Then it will demonstrate how **MSASect** could have been used to calculate the same information. The top chord angle will be calculated and saved, but not used as part of this analysis.



Cross-Section Geometry

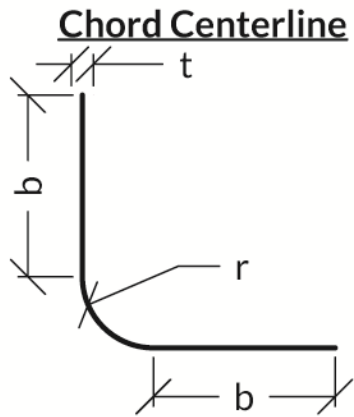

Top Chord

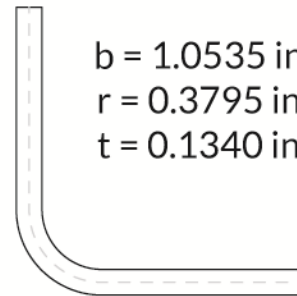

Bottom Chord

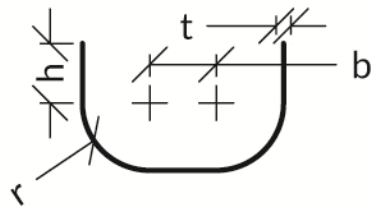
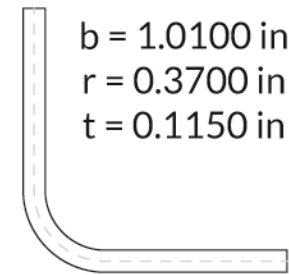

Web Centerline

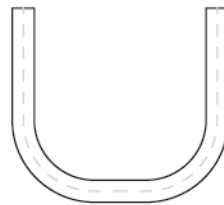

Web 1

$h = 0.5844 \text{ in}$
 $b = 0.2700 \text{ in}$
 $r = 0.3700 \text{ in}$
 $t = 0.1150 \text{ in}$

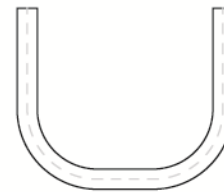

Web 2

$h = 0.5258 \text{ in}$
 $b = 0.2900 \text{ in}$
 $r = 0.3650 \text{ in}$
 $t = 0.1050 \text{ in}$

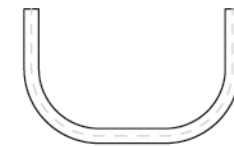

Web 3

$h = 0.3102 \text{ in}$
 $b = 0.3466 \text{ in}$
 $r = 0.3509 \text{ in}$
 $t = 0.0767 \text{ in}$



Importing Section Properties

- 1) From the **Properties** menu select **Input Properties**.
- 2) At the bottom menu bar, **Sections** should already be selected. Copy and paste the values below into the edit box below **|Name| Area Izz Iyy J Cw Zzz Zyy Ayy Azz Ysc Zsc BetaV BetaW Betaw Iyz.** 

All members are entered in a principal orientation. The letter at the end of the name is to help remember the orientation with the corner of the angle members down and the opening of the channels up.

Top Chord (V)	0.36199	0.025692	0.13129	2.1666e-3	4.652e-5	0.083769	0.19214	Inf Inf	-0.4957	00	2.1346	00
Bot Chord (V)	0.29895	0.01956	0.10058	1.3179e-3	3.4339e-5	0.066516	0.09328	Inf Inf	-0.47698	00	2.0602	00
Web 1 (U)	0.29875	0.028641	0.054567	1.317e-3	3.3476e-3	0.081668	0.11919	Inf Inf	-0.74007	00	1.8413	00
Web 2 (U)	0.26093	0.021852	0.047564	9.589e-4	2.5185e-3	0.066672	0.10367	Inf Inf	-0.68065	00	1.7533	00
Web 3 (U)	0.15847	0.0072663	0.027533	3.1075e-4	7.4428e-4	0.029823	0.060575	Inf Inf	-0.46984	00	1.4813	00
RIGID	4	1.33	1.33	2.25	64	4	4	Inf Inf	0	00	0	00

- 3) Click on the **Apply** button.

The section properties of the rigid element are approximated based on a 2" x 2" solid square as it has larger section properties than the majority of the joist elements. Combined with the higher modulus of elasticity will provide the effective rigid link. Care must be taken as too stiff of a link can cause issues with the solver and too soft will add unintended deformations.



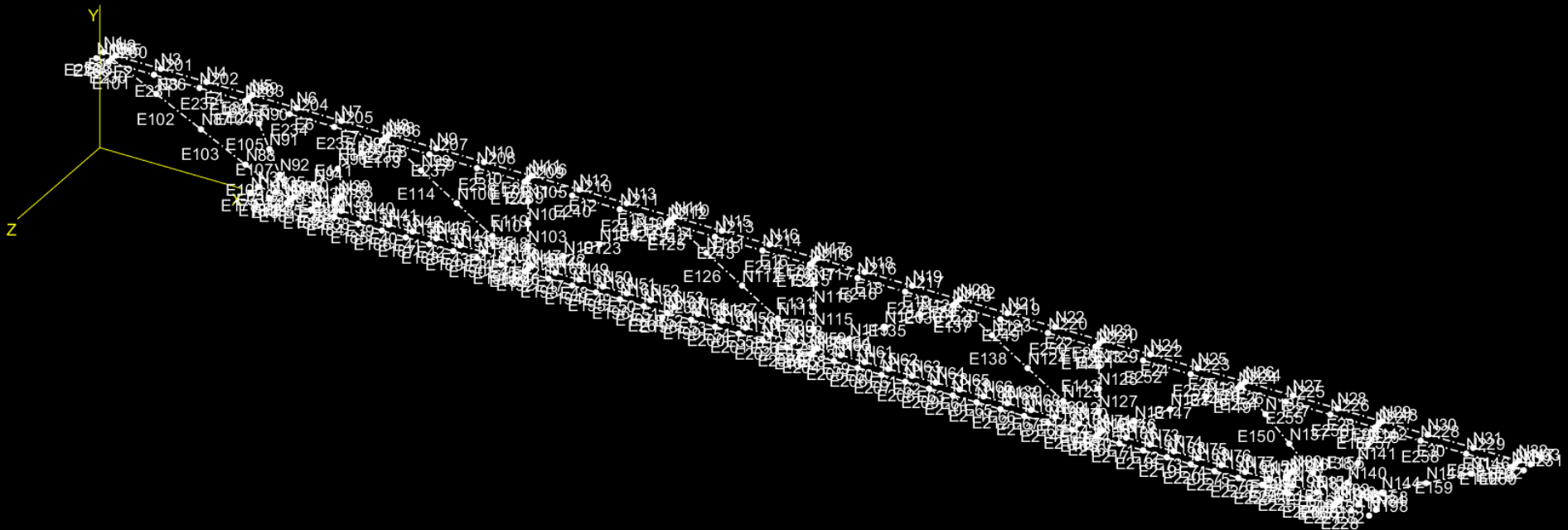



Sections	Enter each section's information as shown separated by spaces per row (perhaps using paste)	Status:	Create additional sections and/or materials
	[Name] Area Izz Iyy J Cw Zzz Zyy Ayy Azz Ysc Zsc BetaV BetaW BetaX Iyz		
	[Top Chord (V)] 0.36199 0.025692 0.13129 2.1666e-3 4.652e-5 0.083769 0.19214 Inf Inf -0.4957 0 0 2.1346 0 0		
	[Bot Chord (V)] 0.29895 0.01956 0.10058 1.3179e-3 3.4339e-5 0.066516 0.09328 Inf Inf -0.47698 0 0 2.0602 0 0		
	[Web 1 (U)] 0.29875 0.028641 0.054567 1.317e-3 3.3476e-3 0.081668 0.11919 Inf Inf -0.74007 0 0 1.8413 0 0		
		Apply	Cancel



Calculating Section Properties

- 1) Outside of MASTAN2, create a text file that summarizes the node and segment data similar to the one shown here. 
- 2) From the **Properties** menu select **Define Section**.
- 3) At the bottom menu bar, click on the pop-up menu on the far right that currently displays **Basic**.
Click on **Advanced**.
- 4) Click on **MSASect**.
- 5) After the interface loads, click the radio button next to **General**. 
- 6) Click **Next** to open the editable general section interface.
- 7) Click **Open** at the bottom of the screen.
- 8) Navigate to the location of the text file. After selecting it, click **Open**.
- 9) Click **Calculate** to determine the properties. 
- 10) Click edit box to right of **Name:** and enter **Top Chord Alt**.
- 11) Click **Export to MASTAN2** to copy values to main program. Click **Close** to return to main program.
- 12) Click **Apply** to save Section 7.



```

C:\Users\SSIRL\Desktop\Angle.txt - Notepad++
File Edit Search View Encoding Language Settings Tools Macro Run
Plugins Window ?
Angle.txt x
1 Nodes
2 1,0.000000,-0.000000
3 2,-0.186234,-0.186234
4 3,-0.372468,-0.372468
5 4,-0.558703,-0.558703
6 5,-0.744937,-0.744937
7 6,-0.805247,-0.823534
8 7,-0.843159,-0.915062
9 8,-0.856090,-1.013284
10 9,-0.843159,-1.111506
11 10,-0.805247,-1.203034
12 11,-0.744937,-1.281631
13 12,-0.558703,-1.467865
14 13,-0.372468,-1.654100
15 14,-0.186234,-1.840334
16 15,0.000000,-2.026568
17 Segments
18 1,1,2,0.134000
19 2,2,3,0.134000
20 3,3,4,0.134000
21 4,4,5,0.134000
22 5,5,6,0.134000
23 6,6,7,0.134000
24 7,7,8,0.134000
25 8,8,9,0.134000
26 9,9,10,0.134000
27 10,10,11,0.134000
28 11,11,12,0.134000
29 12,12,13,0.134000
30 13,13,14,0.134000
31 14,14,15,0.134000
32 End
Ln : 32 Col : 4 Sel : 0 | 0 Windows (CR LF) UTF-8 INS

```

Version to Copy for own Text File

Nodes

```

1,0.000000,-0.000000
2,-0.186234,-0.186234
3,-0.372468,-0.372468
4,-0.558703,-0.558703
5,-0.744937,-0.744937
6,-0.805247,-0.823534
7,-0.843159,-0.915062
8,-0.856090,-1.013284
9,-0.843159,-1.111506
10,-0.805247,-1.203034
11,-0.744937,-1.281631
12,-0.558703,-1.467865
13,-0.372468,-1.654100
14,-0.186234,-1.840334
15,0.000000,-2.026568

```

Segments

```

1,1,2,0.134000
2,2,3,0.134000
3,3,4,0.134000
4,4,5,0.134000
5,5,6,0.134000
6,6,7,0.134000
7,7,8,0.134000
8,8,9,0.134000
9,9,10,0.134000
10,10,11,0.134000
11,11,12,0.134000
12,12,13,0.134000
13,13,14,0.134000
14,14,15,0.134000
End

```



MSASect (Nonsymmetric Section)
_ □ ×

Section Type

Mono-Symmetric I

T-Shape

Z-Shape

C-Shape

L-Shape

Elli-Shape

Rec-Shape

Trap-Shape

General

Dimensions

Please click the Next button to proceed.

Next

Section View

(+) ←----- Z ----- (-)
(-) ----- Y -----> (+)

Section Properties		Name:	<input style="width: 100%;" type="text"/>	Phi=	<input style="width: 100%;" type="text"/>	Status:	<input style="width: 100%;" type="text"/>
Area =	<input style="width: 100%;" type="text"/>	I z-z =	<input style="width: 100%;" type="text"/>	I y-y =	<input style="width: 100%;" type="text"/>	J =	<input style="width: 100%;" type="text"/>
Ysc =	<input style="width: 100%;" type="text"/>	Zsc =	<input style="width: 100%;" type="text"/>	BetaV =	<input style="width: 100%;" type="text"/>	BetaW =	<input style="width: 100%;" type="text"/>
Z w-w =	<input style="width: 100%;" type="text"/>	Z v-v =	<input style="width: 100%;" type="text"/>	A v-v =	<input style="width: 100%;" type="text"/>	A w-w =	<input style="width: 100%;" type="text"/>



MSASect (Nonsymmetric Section)
_ □ ×

Nodes

1	ID:	1	Add
2	Z-Coord. =	0	Modify
3	Y-Coord. =	0	Delete
4			
5			

Segments

1	ID:	1	Add
2	Start Node =	1	Modify
3	End Node =	2	Delete
4			
5			
6	Thickness =	0.134	
7			
8			

Section View

(+)
----- Z -----
(-)

Calculate Beta = 45 Rotate

Section Properties		Name:	Phi = 0	Status: Calculated successfully!
Area =	3.620e-01	I z-z =	2.569e-02	I y-y = 1.313e-01
J =	2.167e-03	Cw =	4.652e-05	
Ysc =	-4.957e-01	Zsc =	0	BetaV = 0
BetaW =	2.135e+00	Betaw =	0	
Z w-w =	8.377e-02	Z v-v =	1.921e-01	I y-z = 0

Reset Open Save Save As

Export to Mastan2 Close



Improving Visual

Currently there are many elements and node labels that make it difficult to understand what is going on. While not necessary, this tutorial will turn off the labels. Following these steps again would allow the user to put the labels back into the model.

1) From the **View** menu select **Labels** and submenu option **Node #s**.

2) From the **View** menu select **Labels** and submenu option **Element #s**.



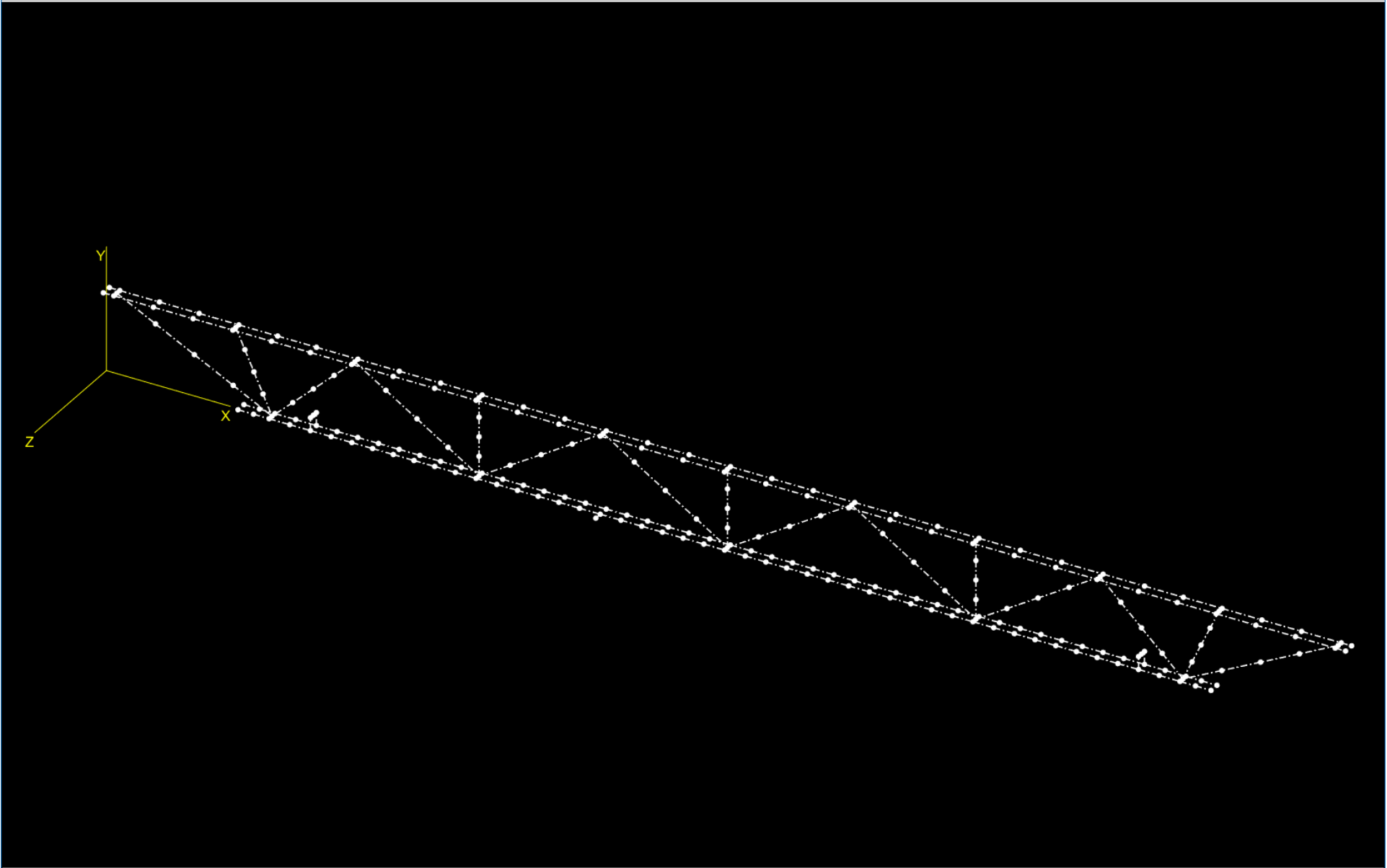



Please enter section properties		Section 8	Name:		MSASect	Status:	Success: Section 7 defined.				
Area =	0	I z-z =	0	I y-y =	0	J =	0	Cw =	0	I y-z =	0
Ysc =	0	Zsc =	0	BetaV =	0	BetaW =	0	Betaw =	0	Advanced v	
Z w-w =	inf	Z v-v =	inf	A v-v =	inf	A w-w =	inf	Apply		Cancel	



Section Properties – Assigning – 1

- 1) From the **Properties** menu select **Attach Section**.
- 2) At the bottom menu bar, use the buttons to the right of **Element(s):** to make the list of elements.
- 3) Click the **Adv** button to open pop-up menu. Click the **Reset** button. To select both top chords, click the check box next to the **X-axis** option. Click the button to the right of **Range (Inclusive)** from **Off** to **On**. Change the edit box to the left of **Y** to **8**.
- 4) Click **Add** to add the top chord elements to the element list. 
- 5) Click on the **Apply** button to assign Section 1 to the top chord elements.
- 6) Change the **Section #** by clicking on the current section number just to the right to open a pop-up menu with all section numbers. Click on **2** to select the “Bot Chord (V)” section.
- 7) Select the **Clr** button located to the right of **Elements:** to clear the list of elements.
- 8) Change the edit box to the left of **Y** to **0**. Change the edit box to the right of **Y** to **8**.
- 9) Click **Add** to add the bottom chord elements to the element list.
- 10) Click on the **Apply** button to assign Section 2 to the bottom chord. 



MASTAN2: C:\Users\SSIRL\Desktop\Joist.mat [17:00]

File View Geometry Properties Conditions Analysis Results

Advanced Element Selection

Parallel to: On

X-axis Y-axis Z-axis

Range (Inclusive) On

-inf	X	+inf
8	Y	+inf
-inf	Z	+inf

Add Remove Reset

Select Section # and element(s) Element(s): 1 2 3 4 5 6 7 8 9 All Clr Adv Status:

Section # 1 Details: Top Chord (V) <Click to see properties> Apply Cancel



MASTAN2: C:\Users\SSIRL\Desktop\Joist.mat [17:00]

File View Geometry Properties Conditions Analysis Results

Advanced Element Selection

Parallel to: On

X-axis Y-axis Z-axis

Range (Inclusive) On

-inf	X	+inf
0	Y	8
-inf	Z	+inf



Add Remove Reset

Select Section # and element(s) Element(s): 33 34 35 36 38 39 40 41 All Clr Adv Status: Success: Section attached.

Section # 2 Details: Bot Chord (V) <Click to see properties> Apply Cancel



Section Properties - Assigning - 2

- 1) Change the **Section #** by clicking on the current section number just to the right to open a pop-up menu with all section numbers. Click on **5** to select the “Web 3 (U)” section.
- 2) Select the **Clr** button located to the right of **Elements:** to clear the list of elements. Click **Reset** at the bottom of the Advanced Element Section.
- 3) Click the check box next to **X-axis** and the check box next to **Z-axis**.
- 4) Click **All** to the right of **Element(s):** and then **Remove** to select all the webs. 
- 5) Click on the **Apply** button to assign Section 5 to all webs temporarily.
- 6) Change the **Section #** by clicking on the current section number just to the right to open a pop-up menu with all section numbers. Click on **6** to select the “RIGID” section
- 7) Select the **Clr** button located to the right of **Elements:** to clear the list of elements.
- 8) Click the check box next to **X-axis**. **Z-axis** should still be selected.
- 9) Click **Add** to select all the rigid connectors. Additionally click on the 4 vertical braces.
- 10) Click on the **Apply** button to assign Section 6 to the rigid connectors. 



MASTAN2: C:\Users\SSIRL\Desktop\Joist.mat

File View Geometry Properties Conditions Analysis Results

Advanced Element Selection

Parallel to:

X-axis Y-axis Z-axis

Range (Inclusive)

-inf	X	+inf
-inf	Y	+inf
-inf	Z	+inf

Select Section # and element(s) Element(s): 37 78 101 102 103 104 105 All Clr Adv Status:

Section # 5 Details: Web 3 (U) <Click to see properties>



MASTAN2: C:\Users\SSIRL\Desktop\Joist.mat

File View Geometry Properties Conditions Analysis Results

Advanced Element Selection

Parallel to: X-axis Y-axis Z-axis

Range (Inclusive) Off

-inf	X	+inf
-inf	Y	+inf
-inf	Z	+inf



Add Remove Reset

Select Section # and element(s) Element(s): 78 83 84 85 86 87 88 89 90 91 92 All Clr Adv Status: Success: Section attached.

Section # 6 Details: RIGID <Click to see properties> Apply Cancel



Section Properties - Assigning - 3

- 1) Change the **Section #** by clicking on the current section number just to the right to open a pop-up menu with all section numbers. Click on **4** to select the “Web 2 (U)” section.
- 2) Select the **Clr** button located to the right of **Elements:** to clear the list of elements.
- 3) Click on all the elements to be assigned Web 2 section properties.
- 4) Assign Section 4 properties by clicking the **Apply** button. 
- 5) Change the **Section #** by clicking on the current section number just to the right to open a pop-up menu with all section numbers. Click on **3** to select the “Web 1 (U)” section.
- 6) Select the **Clr** button located to the right of **Elements:** to clear the list of elements.
- 7) Click on all the elements to be assigned Web 1 section properties.
- 8) Assign Section 3 properties by clicking the **Apply** button. 

MASTAN2: C:\Users\SSIRL\Desktop\Joist.mat

File View Geometry Properties Conditions Analysis Results

Advanced Element Selection

Parallel to: On

X-axis

Y-axis

Z-axis

Range (Inclusive) Off

-inf	X	+inf
-inf	Y	+inf
-inf	Z	+inf

Add Remove Reset

Select Section # and element(s) Element(s): 109 110 112 111 152 151 150 149 All Clr Adv Status: Success: Section attached.

Section # 4 Details: Web 2 (U) <Click to see properties> Apply Cancel



MASTAN2: C:\Users\SSIRL\Desktop\Joist.mat

File View Geometry Properties Conditions Analysis Results

Advanced Element Selection

Parallel to: On

X-axis Y-axis Z-axis

Range (Inclusive) Off

-inf	X	+inf
-inf	Y	+inf
-inf	Z	+inf

Add Remove Reset

Select Section # and element(s) Element(s): 155 158 159 160 106 103 102 101 All Clr Adv Status: Success: Section attached.

Section # 3 Details: Web 1 (U) <Click to see properties> Apply Cancel



Material Properties

- 1) From the **Properties** menu select **Define Material**.
- 2) At the bottom menu bar, click in the edit box just to the right of **E=** and change the **0** to **29000000** (not 29,000,000). Similarly, click in the edit box just to the right of **Fy=** and change the **inf** to **50000**. Next, click in the edit box to the right of **Name:** and type **Steel**. Click on the **Apply** button (Material #1 is now defined with the properties of steel).
- 3) At the bottom menu bar, click in the edit box just to the right of **E=** and change the **0** to **2900000000** (not 2,900,000,000). Next, click in the edit box to the right of **Name:** and type **Rigid**. Click on the **Apply** button. (Material #2 is now defined 100x stiffer and cannot yield.) 



MASTAN2: C:\Users\SSIRL\Desktop\Joist.mat [17:09]

File View Geometry Properties Conditions Analysis Results

Please enter material properties

Material 3	Name:		Status:	Success: Material 2 defined.					
E =	0	v =	0.3	Fy =	inf	Wt Dens. =	0	Apply	Cancel



Material Properties - Assigning

- 1) From the **Properties** menu select **Attach Material**.
- 2) At the bottom menu bar, create the list of elements to be assigned the properties of Material 1 by clicking on the **All** button to the right of **Elements:**. Click on the **Apply** button. (Note that elements with assigned section and material properties turn solid.)
- 3) Change the **Material #** by clicking on the current material number just to the right to open a pop-up menu with all section numbers. Click on **2** to select the Rigid material.
- 4) Select the **Clr** button located to the right of **Elements:** to clear the list of elements.
- 5) Click the **Adv** button to open pop-up menu. **Z-axis** check box should be selected.
- 6) Click **Add** to select all the rigid connectors. Additionally click on the 4 vertical braces. Clicking **Adv** will close the pop-up menu making it easier to click all members.
- 7) Click on the **Apply** button to assign Material 2. 



MASTAN2: C:\Users\SSIRL\Desktop\Joist.mat [17:09]

File View Geometry Properties Conditions Analysis Results

Advanced Element Selection

Parallel to: X-axis Y-axis Z-axis

Range (Inclusive) Off

-Inf	X	Inf
-Inf	Y	Inf
-Inf	Z	Inf



Add Remove Reset

Select Material # and element(s) Element(s): 83 84 85 86 87 88 89 90 91 92 93 All Clr Adv Status: Success: Material attached.

Material # 2 Details: Rigid <Click to see properties> Apply Cancel



Support Conditions - Bracing

- 1) From the **Conditions** menu select **Define Fixities**.
- 2) At the bottom menu bar, define the lateral support by clicking in the **check box** just to the left of **Z-disp.**
- 3) Click the **Adv** menu. Change the edit box to the left of **Y** from **-Inf** to **15**. Change the edit box to the left of **Z** from **-Inf** to **-0.1** and the edit box to the right of **Z** from **Inf** to **0.1**. Click the **Add** button.
- 4) From the **View** menu select **Zoom Box**. Click to draw a small box around the brace connection on the bottom chord at one end. Click on the middle node to add to the list of nodes. 
- 5) From the **View** menu select **Fit**. From the **View** menu select **Zoom Box**. Click to draw a small box around the brace connection at the other end. Click on the middle node to add to the list of nodes.
- 6) Click on the **Apply** button.
- 7) From the **View** menu select **Fit**. 

MASTAN2: C:\Users\SSIRL\Desktop\Joist2.mat

File View Geometry Properties Conditions Analysis Results

Advanced Node Selection

Range (Inclusive)

-Inf	X	Inf
15	Y	Inf
-.1	Z	.1

Add Remove Reset

Please select node(s) and fixity(s) Node(s): 85 89 98 106 110 118 122 130 134 All Clr Adv Status:

X-disp Y-disp Z-disp X-rot Y-rot Z-rot

Apply Cancel



MASTAN2: C:\Users\SSIRL\Desktop\Joist.mat [17:09]

File View Geometry Properties Conditions Analysis Results

Advanced Node Selection

Range (Inclusive)

-Inf	X	Inf
15	Y	Inf
-0.1	Z	0.1

Add Remove Reset

Please select node(s) and fixity(s) Node(s): 85 89 98 106 110 118 122 130 134 All Clr Adv Status: Success: Node fixities defined.

X-disp Y-disp Z-disp X-rot Y-rot Z-rot Apply Cancel



Support Conditions – Pin and Roller

- 1) To update the end nodes to provide pin supports, start by clicking **Clr** to empty the list of nodes.
- 2) From the **View** menu select **Zoom Box**. Click to draw a small box around the right roller node. It should currently just have a lateral support. Click on the node to add to the list of nodes.
- 3) Define a roller support by clicking in the **check box** just to the left of **Y-disp**. **Z-disp** should still be selected from before.
- 4) From the **View** menu select **Fit**.
- 5) Click on the **Apply** button.
- 6) From the **View** menu select **Zoom Box**. Click to draw a small box around the left pin node.
- 7) Click on the **Clr** button to empty the list of nodes. Click on the left pin.
- 8) Define a pin support by clicking in the **check box** just to the left of **X-disp**. **Y-disp** and **Z-disp** should still be selected from before.
- 9) From the **View** menu select **Fit**.
- 10) Click on the **Apply** button. 



MASTAN2: C:\Users\SSIRL\Desktop\Joist.mat [17:09]

File View Geometry Properties Conditions Analysis Results

Advanced Node Selection

Range (Inclusive)		
-Inf	X	Inf
15	Y	Inf
-0.1	Z	0.1

Add Remove Reset



Please select node(s) and fixity(s) Node(s): 85 All Clr Adv Status: Success: Node fixities defined.

X-disp Y-disp Z-disp X-rot Y-rot Z-rot

Apply Cancel



Chord Member Orientation

- 1) From the **View** menu select **Labels** and submenu option **Element local (x'-y'-z') axes**. The purple line shows the positive x axis. The blue line shows the positive geometric y axis. The red line shows the positive geometric z axis. Based on the orientation of the angle sections as input, the y axis represents the direction from the centroid to the corner of the angle. 
- 2) From the **Geometry** menu select **Re-orient Element(s)**.
- 3) At the bottom menu bar, click in the edit box to the right of **Beta (Deg)** and change **0.0** to **135**.
- 4) Click the **Adv** button to open pop-up menu. Click the **Reset** button. To select the +z top chord angle, click the check box next to the **X-axis** option. Click the button to the right of **Range (Inclusive)** to **On**. Change the edit box to the left of **Y** to **8**. Change the edit box to the left of **Z** to **0**.
- 5) Click **Add** to add all these elements to the element list. Click on the **Apply** button to re-orient the elements. 
- 6) Repeat this for the remaining 3 angle members orienting in the correct direction with the values shown in the table:

Member	-Z Top	+Z Bottom	-Z Bottom
Beta	-135	45	-45
Y-Range	8 to inf	0 to 8	0 to 8
Z-Range	-2 to 0	0 to 2	-2 to 0

 Iso. View

 Side View



MASTAN2: C:\Users\SSIRL\Desktop\Joist.mat [17:09]

File View Geometry Properties Conditions Analysis Results

The image shows a 3D finite element model of a joist structure. The model is composed of numerous nodes (white dots) and elements (lines). Displacement vectors are shown as colored arrows (red, cyan, blue) originating from the nodes. A 3D coordinate system is visible on the left, with axes labeled X, Y, and Z. The X-axis is horizontal, the Y-axis is vertical, and the Z-axis is diagonal.

Advanced Node Selection

Range (Inclusive)

-Inf	X	Inf
15	Y	Inf
-0.1	Z	0.1

Add Remove Reset

Please select node(s) and fixity(s) Node(s): 85 All Clr Adv Status: Success: Node fixities defined.

X-disp Y-disp Z-disp X-rot Y-rot Z-rot

Apply Cancel



MASTAN2: C:\Users\SSIRL\Desktop\Joist.mat [17:09]

File View Geometry Properties Conditions Analysis Results

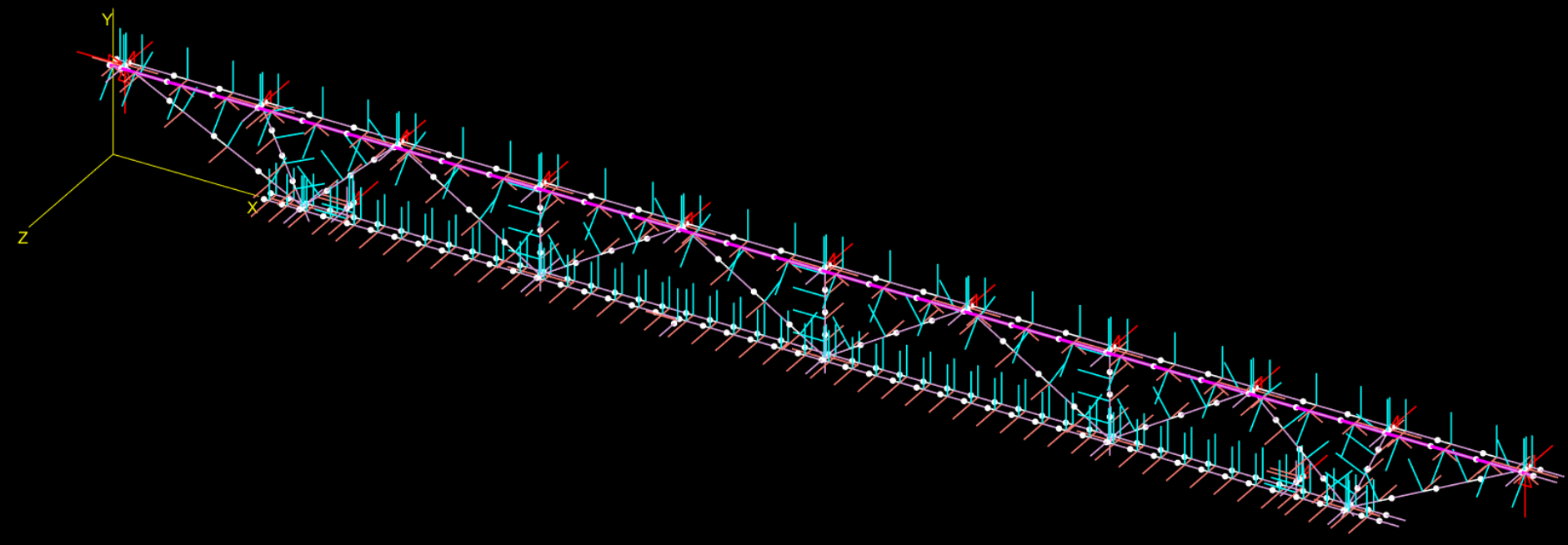

Advanced Element Selection

Parallel to: On

X-axis Y-axis Z-axis

Range (Inclusive) On

-inf	X	+inf
8	Y	+inf
0	Z	+inf

Add Remove Reset

Please select element(s) and define new beta angle and/or switch element ends Switch Element Ends Status: Success: Element(s) oriented.

Element(s): 229 230 231 232 233 234 235 236 237 238 All Clr Adv Beta (Deg) 135 Apply Cancel



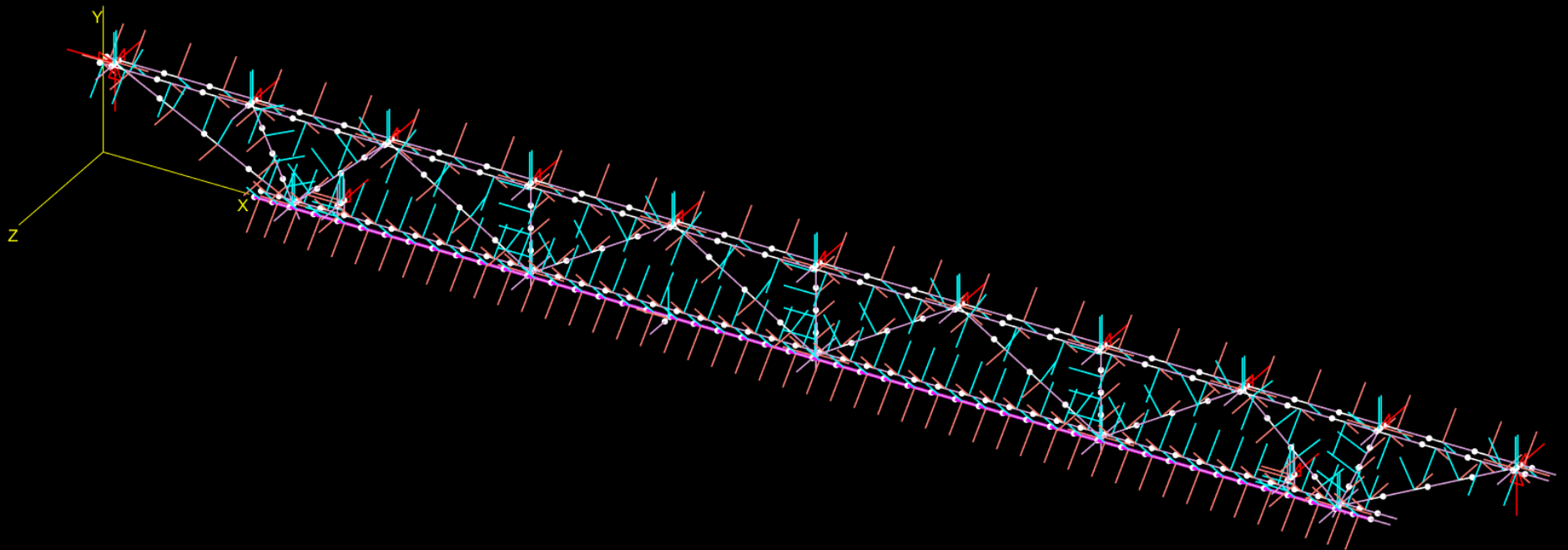

Advanced Element Selection

Parallel to:

X-axis Y-axis Z-axis

Range (Inclusive)

-inf	X	+inf
0	Y	8
0	Z	2

Please select element(s) and define new beta angle and/or switch element ends Switch Element Ends Status: Success: Element(s) oriented.

Element(s): 179 180 181 182 184 185 186 187 188 189 All Cir Adv Beta (Deg) 45



Note: Due to the input orientation of the chord angles, the blue line illustrates a line from the heel of the angle through the centroid. The white angle outlines are shown just for reference. They are not part of the MASTAN2 interface.

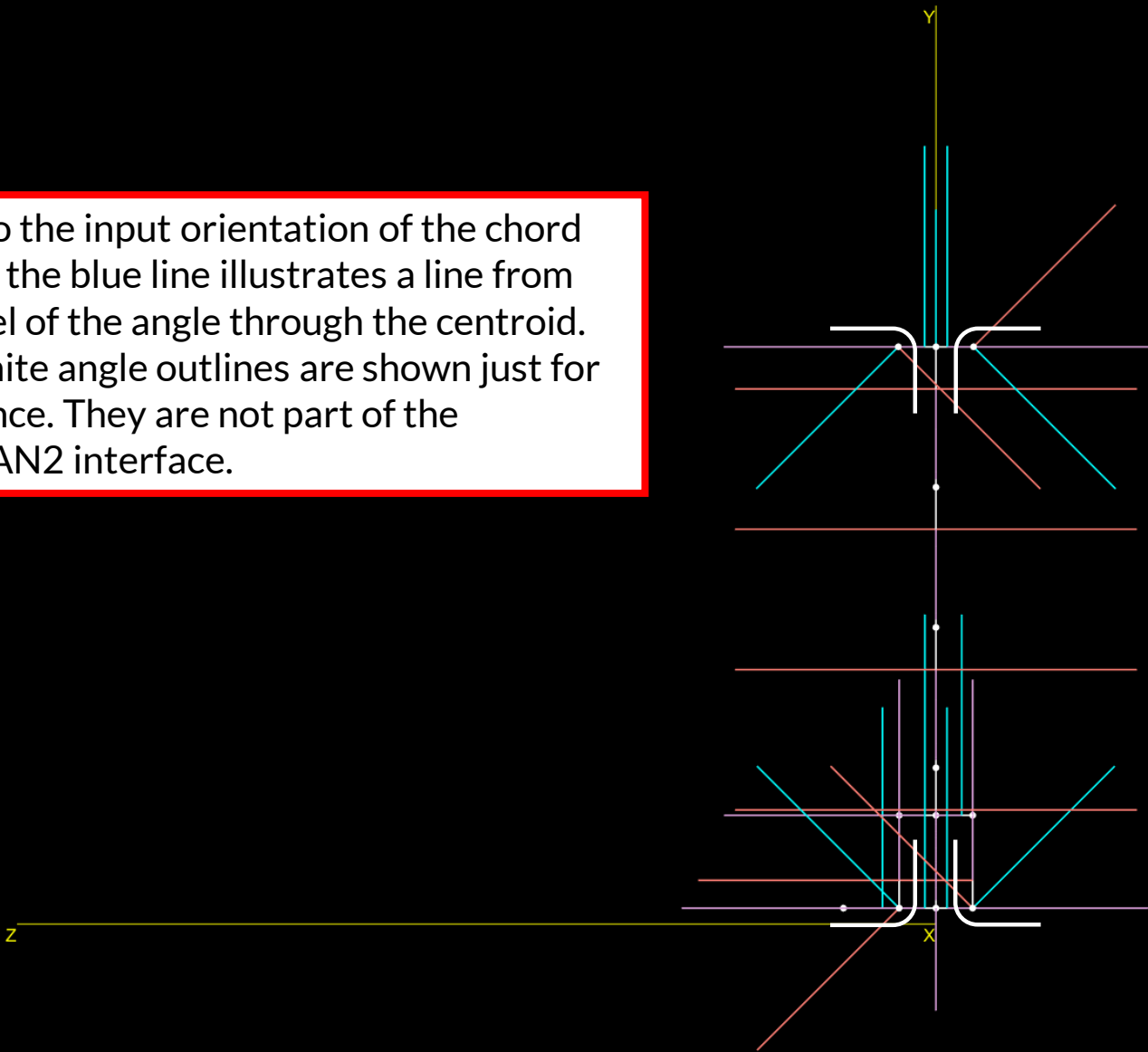

Please select element(s) and define new beta angle and/or switch element ends

Switch Element Ends Status: Success: Element(s) oriented.

Element(s): 179 180 181 182 184 185 186 187 188 189 190 All Clr Adv Beta (Deg) 45 Apply Cancel





Web Member Orientation

Based on the orientation of the web sections as input, the y axis points in the direction of the opening of the channel.

- 1) At the bottom menu bar, click in the edit box to the right of **Beta (Deg)** and update it to **180**.
- 2) On the **Advanced Element Selection** pop-up, click the **Reset** button. Click the check box next to the **X-axis** and **Z-axis** option. Create the list of webs to be flipped by clicking on the **All** button to the right of **Elements**. Then click on **Remove**.
- 3) Manually click the 4 vertical braces, the members assigned Web 2, and the vertical web to the right of center.

Note: If you are having trouble seeing the webs that were unselected, look at the image associated with Step 5 now. The same elements are still selected without all the local axes information on the screen. Also, available again is the diagram with web orientations. 

- 4) Click on the **Apply** button to re-orient the elements. 
- 5) From the **View** menu select **Labels** and submenu option **Element local (x'-y'-z') axes**. 



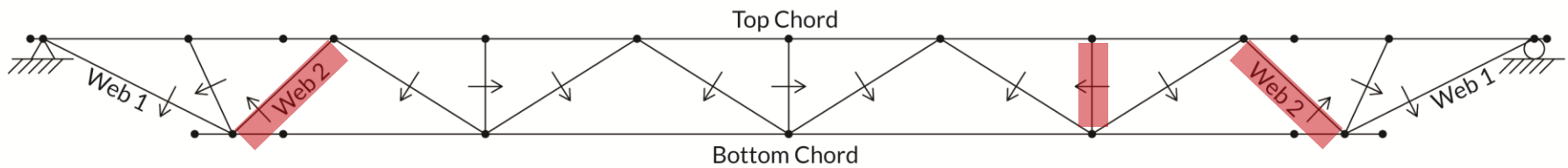
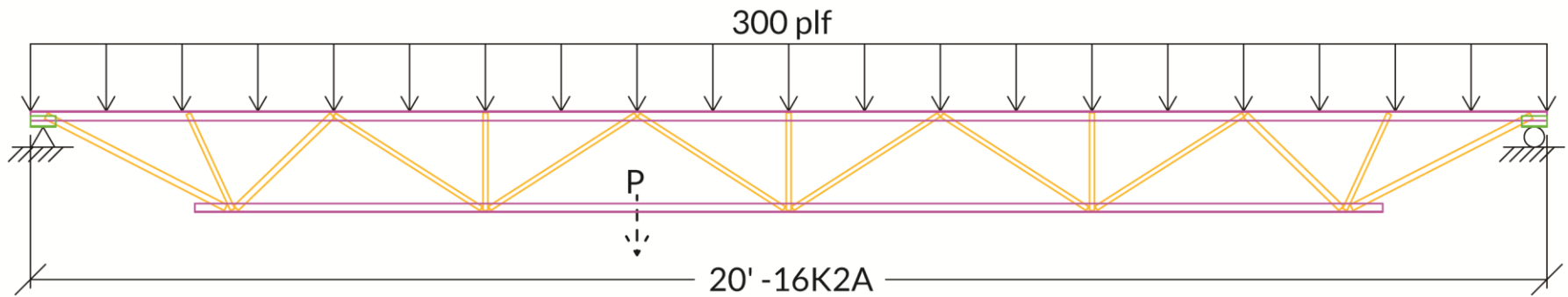

Arrows indicate the open side of the web channels. Web members not otherwise labeled are Web 3

Web members highlighted in red do not need to be flipped as the sections were defined. These are the members that are to be unselected.



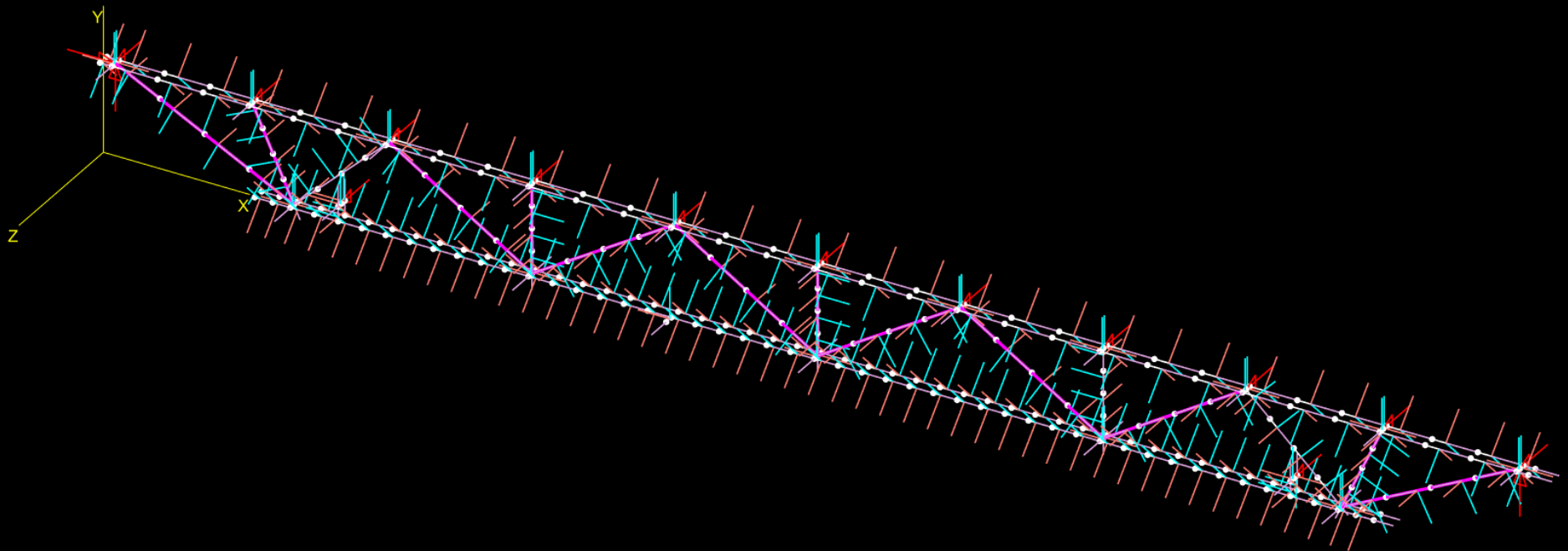

Advanced Element Selection

Parallel to:

X-axis Y-axis Z-axis

Range (Inclusive)

-inf	X	+inf
-inf	Y	+inf
-inf	Z	+inf

Please select element(s) and define new beta angle and/or switch element ends Switch Element Ends Status: Success: Element(s) oriented.

Element(s): 101 102 103 104 105 106 107 108 113 114 115 116 All Cir Adv Beta (Deg) 180



MASTAN2: C:\Users\SSIRL\Desktop\Joist.mat [17:09]

File View Geometry Properties Conditions Analysis Results

The image shows a 3D model of a joist structure in a coordinate system with X, Y, and Z axes. The joist is composed of several parallel members connected by a network of diagonal and vertical members. A selection dialog box titled "Advanced Element Selection" is open in the bottom right corner. The dialog has a "Parallel to:" section with "On" selected and checkboxes for "X-axis" (checked), "Y-axis" (unchecked), and "Z-axis" (checked). The "Range (Inclusive)" section has "Off" selected and three rows for X, Y, and Z, each with "-inf" and "+inf" values. Below the dialog is a status bar with the text "Please select element(s) and define new beta angle and/or switch element ends". To the right of this text is a "Switch Element Ends" checkbox. Further right is a "Status:" label followed by "Success: Element(s) oriented.". At the bottom of the status bar, there is a list of element IDs: "Element(s): 101 102 103 104 105 106 107 108 113 114 115 116". To the right of the list are buttons for "All", "Clr", "Adv", and "Beta (Deg)" (checked). Further right is a text field containing "180". At the bottom right of the status bar are "Apply" and "Cancel" buttons.

Advanced Element Selection

Parallel to:

X-axis Y-axis Z-axis

Range (Inclusive)

-inf	X	+inf
-inf	Y	+inf
-inf	Z	+inf

Please select element(s) and define new beta angle and/or switch element ends Switch Element Ends

Status: Success: Element(s) oriented.

Element(s): 101 102 103 104 105 106 107 108 113 114 115 116 All Clr Adv Beta (Deg) 180



Adding Warping Effects

- 1) From the **Geometry** menu select **Define Connections** and submenu option **Torsion**.
- 2) At the bottom menu bar, click on the menu to the right of **Warping Restraint for Node i** and set the value to **Continuous**. Repeat this for the **Warping Restraint for Node j**.
- 3) Click the **Adv** button to open pop-up menu. Unmark the check box next to the **X-axis** option. The check box next to the **Z-axis** option should still be selected.
- 4) Create the list of elements to be assigned continuous warping by clicking on the **All** button to the right of **Elements:**. Then click on **Remove**. Click on the 4 vertical braces to remove them.
- 5) Click on the **Apply** button. 

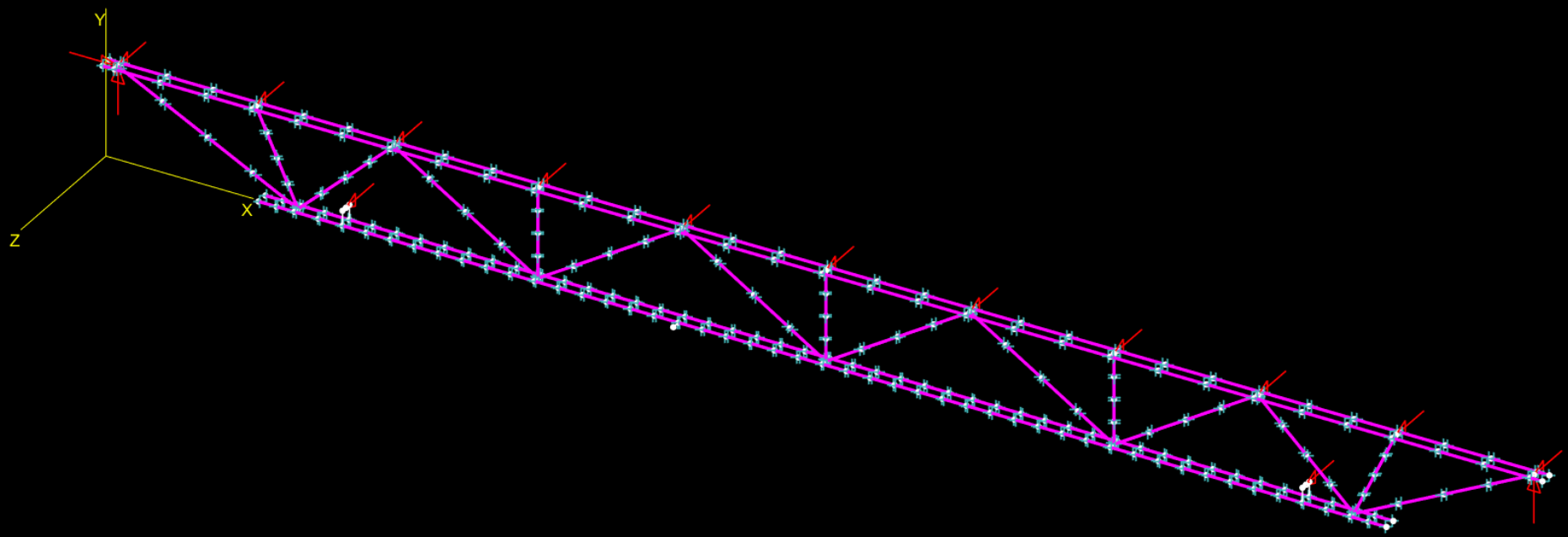

Advanced Element Selection

Parallel to: X-axis Y-axis Z-axis

Range (Inclusive) Off

-Inf	X	Inf
-Inf	Y	Inf
-Inf	Z	Inf



Add Remove Reset

Define element(s) and warping restraint Element(s): 1 2 3 4 5 6 7 8 9 10 11 12 13 14 15 All Clr Adv Status: Success: Warping Restraint defined.

Node i	Warping Restraint	Continuous	Node j	Warping Restraint	Continuous	Apply	Cancel
--------	-------------------	------------	--------	-------------------	------------	-------	--------



Adding Warping Effects – Starting Node

- 1) Click **Clr** to empty the list of elements.
- 2) Click on the menu to the right of **Warping Restraint for Node i** and set the value to **Free**. Node j is set from a previous step.
- 3) Click on the left most element of each chord. 
- 4) Click on the **Apply** button.
- 5) Click **Clr** to empty the list of elements.
- 6) Click on the menu to the right of **Warping Restraint for Node i** and set the value to **Fixed**. Node j is set from a previous step.
- 7) Click on the top end of all 15 web members
- 8) Click on the **Apply** button. 



MASTAN2: C:\Users\SSIRL\Desktop\Joist2.mat

File View Geometry Properties Conditions Analysis Results

Define element(s) and warping restraint Element(s): 179 33 1 229 All Clr Adv Status: Success: Warping Restraint defined.

Node i Warping Restraint Free Node j Warping Restraint Continuous Apply Cancel



MASTAN2: C:\Users\SSIRL\Desktop\Joist.mat [17:22]

File View Geometry Properties Conditions Analysis Results

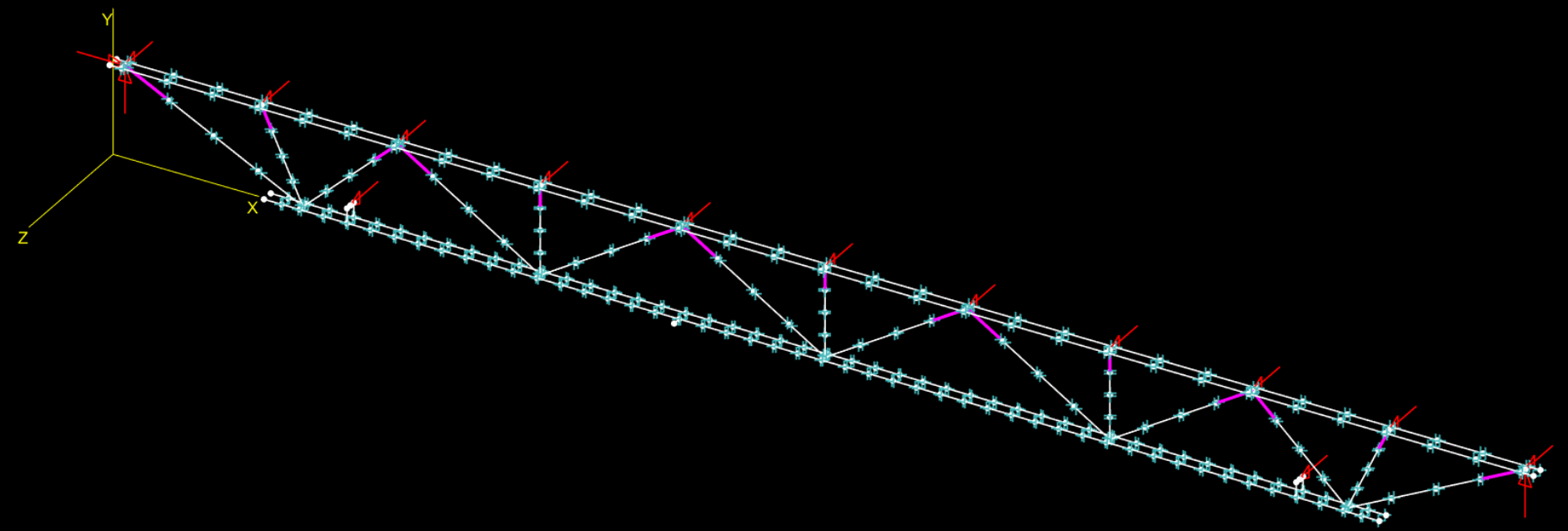

Advanced Element Selection

Parallel to: X-axis Y-axis Z-axis

Range (Inclusive) Off

-Inf	X	Inf
-Inf	Y	Inf
-Inf	Z	Inf



Add Remove Reset

Define element(s) and warping restraint Element(s): 101 104 112 113 120 124 125 132 All Clr Adv Status: Success: Warping Restraint defined.

Node i	Warping Restraint	Fixed	Node j	Warping Restraint	Continuous	Apply	Cancel
--------	-------------------	-------	--------	-------------------	------------	-------	--------



Adding Warping Effects – Ending Node

- 1) Click **Clr** to empty the list of elements.
- 2) Click on the menu to the right of **Warping Restraint for Node i** and set the value to **Continuous**.
Click on the menu to the right of **Warping Restraint for Node j** and set the value to **Free**.
- 3) Click on the right most element of each chord.
- 4) Click on the **Apply** button. 
- 5) Click **Clr** to empty the list of elements.
- 6) Click on the menu to the right of **Warping Restraint for Node j** and set the value to **Fixed**. Node i is set from a previous step.
- 7) Click on the bottom end of all 15 web members.
- 8) Click on the **Apply** button. 



MASTAN2: C:\Users\SSIRL\Desktop\Joist2.mat

File View Geometry Properties Conditions Analysis Results

Define element(s) and warping restraint

Element(s): 82 260 32 228 All Clr Adv Status: Success: Warping Restraint defined.

Node i Warping Restraint Continuous Node j Warping Restraint Free Apply Cancel



MASTAN2: C:\Users\SSIRL\Desktop\Joist.mat [17:22]

File View Geometry Properties Conditions Analysis Results

Advanced Element Selection

Parallel to: X-axis Y-axis Z-axis

Range (Inclusive) Off

-Inf	X	Inf
-Inf	Y	Inf
-Inf	Z	Inf



Add Remove Reset

Define element(s) and warping restraint Element(s): 106 108 109 116 117 121 129 128 All Clr Adv Status: Success: Warping Restraint defined.

Node i Warping Restraint Continuous Node j Warping Restraint Fixed Apply Cancel



End Moment Release

- 1) From the **Geometry** menu select **Define Connections** and submenu option **Flexure**.
- 2) At the bottom menu bar, click on the menu to the right of **Type** for **Node i** and set the value to **Semi-Rigid**.
- 3) In the edit box to the right of **kz** change **inf** to **0.001**.
- 4) Click on the top end of all 15 web members to create the list of elements.
- 5) Click on the **Apply** button. 
- 6) Click on the menu to the right of **Type** for **Node i** and set the value to **Rigid**. Click on the menu to the right of **Type** for **Node j** and set the value to **Semi-Rigid**.
- 7) In the edit box to the right of **kz** change **inf** to **0.001**.
- 8) Click **Clr** to empty the list of elements.
- 9) Click on the bottom end of all 15 web members to create the list of elements.
- 10) Click on the **Apply** button. 



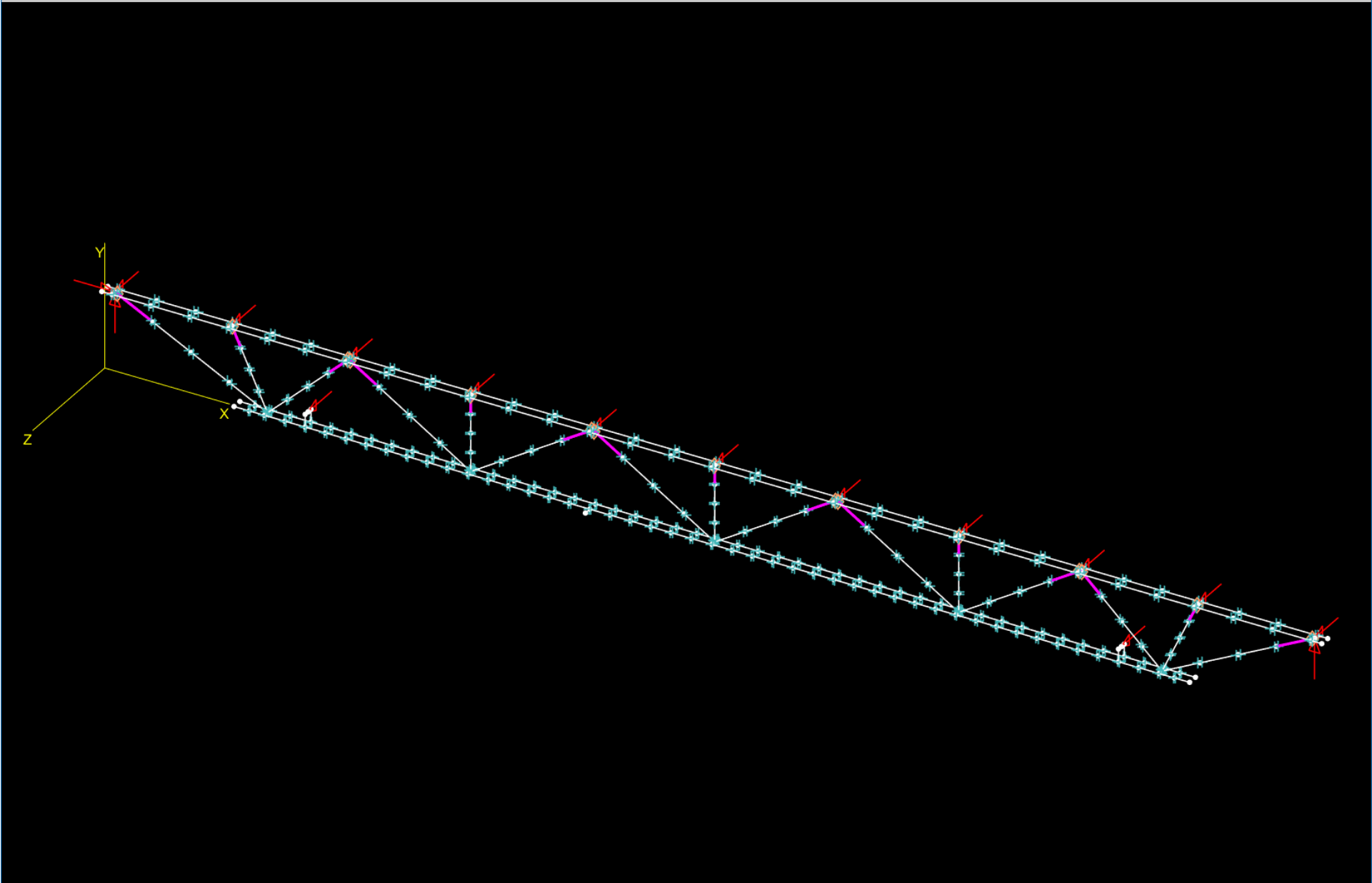

Define element(s) and connections		Element(s):		101 104 112 113 120 124 125 132	All	Clr	Adv	Status:	Success: Connection(s) defined.	
Node i	Type	Semi-Rigid	kz	0.001	ky	inf	Mpz	inf	Mpy	inf
Node j	Type	Rigid	kz	inf	ky	inf				

Apply Cancel



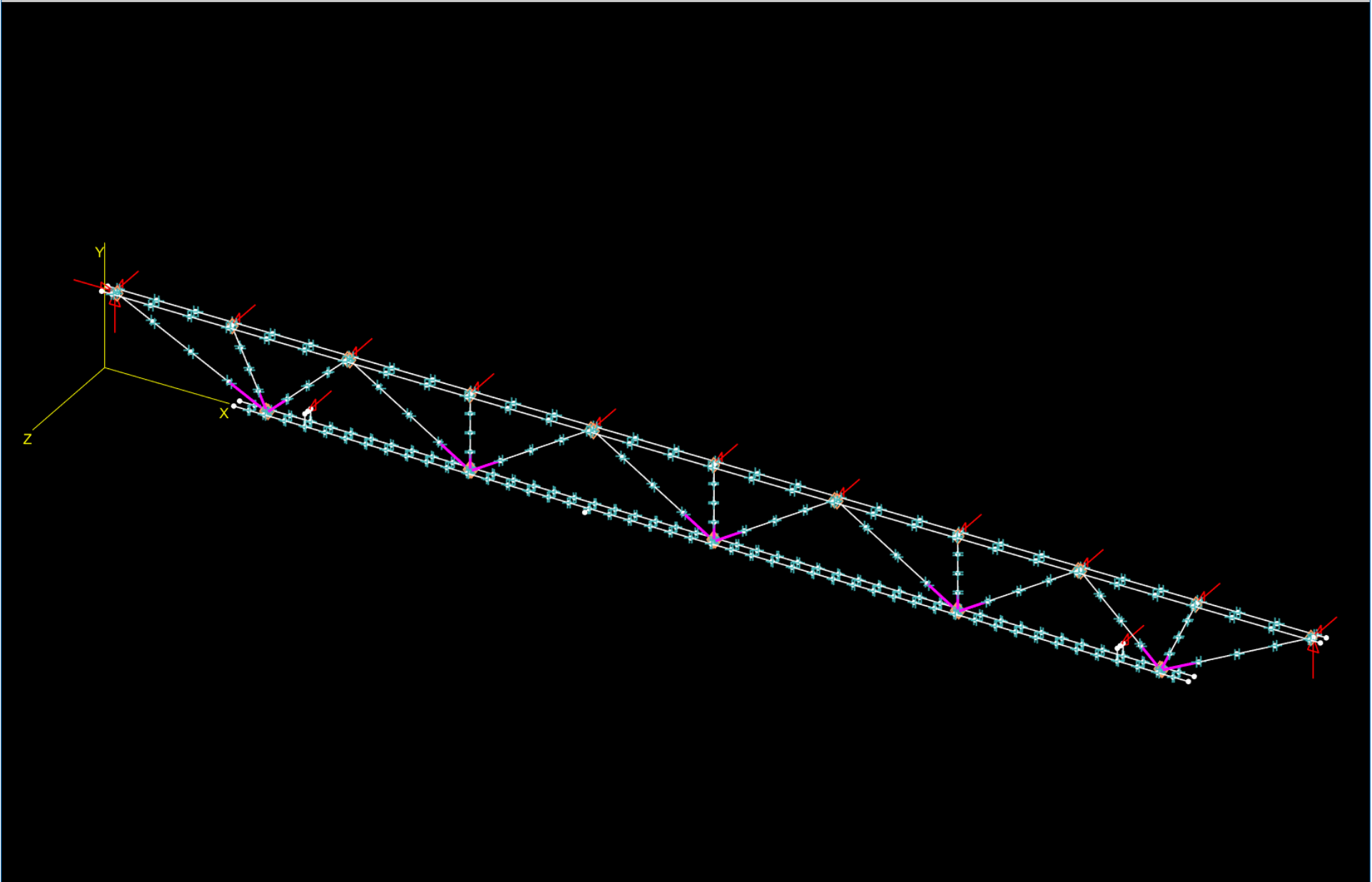

Define element(s) and connections		Element(s):		106 108 109 116 117 121 128 129	All	Clr	Adv	Status:	Success: Connection(s) defined.	
Node i	Type	Rigid	kz	inf	ky	inf				
Node j	Type	Semi-Rigid	kz	0.001	ky	inf	Mpz	inf	Mpy	inf

Apply Cancel



Section 5: Loading and Analysis

Distributed Loading

- 1) From the **Conditions** menu select **Define Uniform Loads**.
- 2) At the bottom menu bar, click on **Element(s) local x'-y'-z'** to open the drop down menu. Select **System global X-Y-Z**. In the edit box just to the right of **wy =** change **0** to **-12.5**.
- 3) Click the **Adv** button to open pop-up menu. Click the check box next to the **Z-axis** option to remove it. Click the check box next to the **X-axis** option. Click the **Off** button to the right of **Range (Inclusive)** to change it to **On**. Change the edit box to the left of **Y** to **8**.
- 4) Click **Add** to add the top chord elements to the element list.
- 5) Click on the **Apply** button. The load will be split into the local element directions.
- 6) From the **View** menu select **Fit**. 

MASTAN2: C:\Users\SSIRL\Desktop\Joist.mat [17:27]

File View Geometry Properties Conditions Analysis Results

Advanced Element Selection

Parallel to: On

X-axis

Y-axis

Z-axis

Range (Inclusive) On

-Inf	X	Inf
8	Y	Inf
-Inf	Z	Inf

Add Remove Reset

Please define element(s) and loads

Element(s):	1	2	3	4	5	6	7	8	9	All	Clr	Adv
-------------	---	---	---	---	---	---	---	---	---	-----	-----	-----



Status: Success: Element loads defined.

Input ref.	System global X-Y-Z	wx	0	wy	-12.5	wz	0
------------	---------------------	----	---	----	-------	----	---

Apply Cancel



Uniform Loading Elastic Analysis

- 1) From the **Analysis** menu select **Static** and submenu option **2nd-Order Elastic**.
- 2) At the bottom menu bar, the **Analysis Type:** should already be set to **Space Frame** as desired.
- 3) Click on the **Apply** button to perform the analysis. 
- 4) From the **Results** menu select **Diagrams** and submenu option **Deflected Shape**.
- 5) At the bottom menu bar, click on the **Apply** button. 

To better see what deformation is occurring, it can be useful to make use of the other defined view.

From the **View** menu select **Defined Views** and make use of the submenu options for these ideas.

- 1) Option **Front view: x-y.**: How the vertical deflection is varying along the length
- 2) Option **Side view: y-z.**: How big the lateral deflection is compared to the joist
- 3) Option **Top view: x-z.**: How the lateral deflection varies along the length
- 4) Option **Isometric: x-y-z.**: Will return to the original view

It may be desired to update the deflected shape diagram with different scale factors during this process.



MASTAN2: C:\Users\SSIRL\Desktop\Joist.mat [17:27]

File View Geometry Properties Conditions Analysis Results

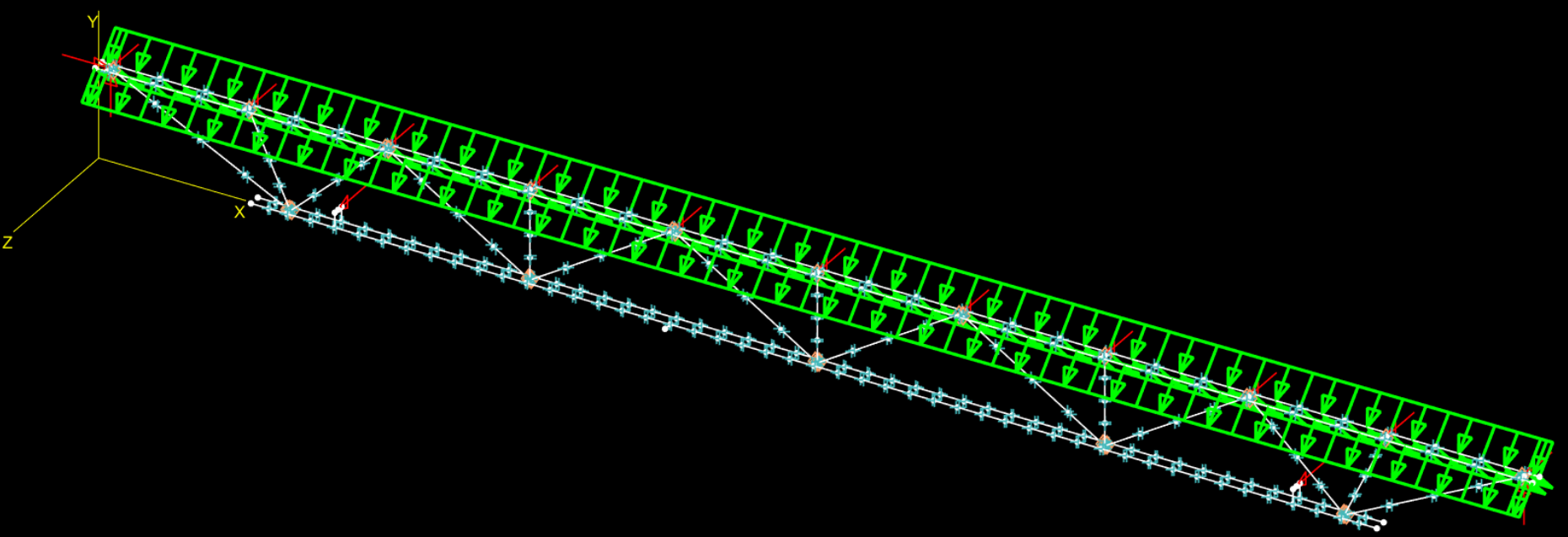

The image shows a 3D finite element model of a joist structure. The structure is a long, narrow beam with a cross-section of a joist. It is oriented along the X-axis. A distributed load is applied to the top surface of the joist, represented by a series of green downward-pointing arrows. The model is composed of a mesh of nodes and elements. A coordinate system is shown with the X-axis pointing right, the Y-axis pointing up, and the Z-axis pointing out of the page. The status bar at the bottom indicates the analysis is complete.

Second-Order Elastic Static Analysis Status: **Incr # 10, Applied Load Ratio = 1.000 --> Success: Analysis Complete**

Solution Type: Predictor-Corrector Incr Size: 0.1 Max. # of Incrs: 10 Max. Appl. Ratio: 1

Analysis Type: Space Frame [Kff] Start New Apply Cancel



MASTAN2: C:\Users\SSIRL\Desktop\Joist.mat [17:27]

File View Geometry Properties Conditions Analysis Results

**** Deflected Shape: 2nd-Order Elastic, Incr # 10, Applied Load Ratio = 1 ****

Define element(s) and parameters

Element(s):	All	All	Clr	Adv	Status:	Success: Deflection shown			
Defl Line Type	Solid	Scale	10	# of pts	10	<input type="checkbox"/> Animate	(10) 1.000	Apply	Cancel



Uniform Loading Results

- 1) From the **Results** menu select **Node Displacements**.
- 2) On the undeflected shape, click on the midspan node of interest, node **173**, and the displacements for base 6 degree of freedoms are provided in the bottom menu bar. 

Calculated vertical deflection: 0.59 in

Estimated deflection using SJI recommendations:

$$I_j = 26.767 \cdot W \cdot L^3 \cdot 10^{-6} = 26.767 \cdot 297plf \cdot (20ft - 4in)^3 \cdot 10^{-6} = 60.47in^4$$

$$\delta = 1.15 \cdot \frac{5WL^4}{384EI} = 1.15 \cdot \frac{5 \cdot 300plf(20ft - 4in)^4}{384 \cdot 29000ksi \cdot 60.47in^4} = 0.66in$$

Estimation using area of chords to calculate I:

$$I_A = 2 \cdot (0.29895in^2 \cdot (8.282in)^2 + 0.36199in^2 \cdot (15.121in - 8.282in)^2) = 74.87in^4$$

$$\delta = 1.15 \cdot \frac{5WL^4}{384EI} = 1.15 \cdot \frac{5 \cdot 300plf(20ft - 4in)^4}{384 \cdot 29000ksi \cdot 74.87in^4} = 0.53in$$

- 3) From the **Results** menu select **Element Forces**.
- 4) On the undeflected shape, click on the span element of interest, element **204**, and the internal forces are provided in the bottom menu bar. These are the forces at the start of the member. 



MASTAN2: C:\Users\SSIRL\Desktop\Joist.mat [17:27]

File View Geometry Properties Conditions Analysis Results

**** Deflected Shape: 2nd-Order Elastic, Incr # 10, Applied Load Ratio = 1 ****

Node:	173	Disp X	-0.04858	Disp Y	-0.5921	Disp Z	1.466e-09	Status:	Success: Disp. at ALR = 1.0000
Displacements	Rot X	-1.294e-09	Rot Y	2.899e-12	Rot Z	1.686e-11	(10) 1.000	Apply	Cancel



MASTAN2: C:\Users\SSIRL\Desktop\Joist.mat [17:27]

File View Geometry Properties Conditions Analysis Results

**** Deflected Shape: 2nd-Order Elastic, Incr # 10, Applied Load Ratio = 1 ****

El #	204	N173:N174	P	5537	Vy	-8.166	Vz	10.09	(10) 1.000	Success: El Forces at ALR = 1.0000
		0.00L	Tx	5.109	My	-303.7	Mz	101.6	B	0.01403

Apply Cancel



Section 6: Hanging Load Analysis

Eccentric Loading

- 1) From the **Results** menu select **Diagrams** and submenu option **None**.
- 2) From the **Conditions** menu select **Define Forces**.
- 3) At the bottom menu bar, click in the edit box just to the right of **PY =** and change **0** to **-100** to create a handing load.
- 4) Click on the node at the tip of the eccentric arm created at the end of the geometry modeling, node **232**.
- 5) Click on the **Apply** button. 



MASTAN2: C:\Users\SSIRL\Desktop\Joist.mat [17:27]

File View Geometry Properties Conditions Analysis Results

The image shows a 3D finite element model of a joist structure. The structure is a long, narrow beam with a cross-section of a joist. It is oriented along the X-axis. A distributed load is applied to the top surface of the joist, represented by a series of green downward-pointing arrows. The model is composed of a mesh of nodes and elements. A coordinate system is shown with the X-axis along the length of the joist, the Y-axis pointing upwards, and the Z-axis pointing outwards. The status bar at the bottom indicates that forces have been defined at 232 nodes. The force values are PX = 0, PY = -100, and PZ = 0. The status bar also includes buttons for 'Apply' and 'Cancel'.

Please define node(s) and forces	Node(s):	232	All	Clr	Adv	Status:	Success: Forces at nodes defined.
PX =	0	PY =	-100	PZ =	0	Apply	Cancel



Eccentrically Loaded Joist Elastic Analysis

- 1) From the **Analysis** menu select **Static** and submenu option **2nd-Order Elastic**.
- 2) At the bottom menu bar, the **Analysis Type:** should already be set to **Space Frame** as desired.
- 3) Click on the **Apply** button to perform the analysis. 

MASTAN2: C:\Users\SSIRL\Desktop\Joist.mat [17:27]

File View Geometry Properties Conditions Analysis Results

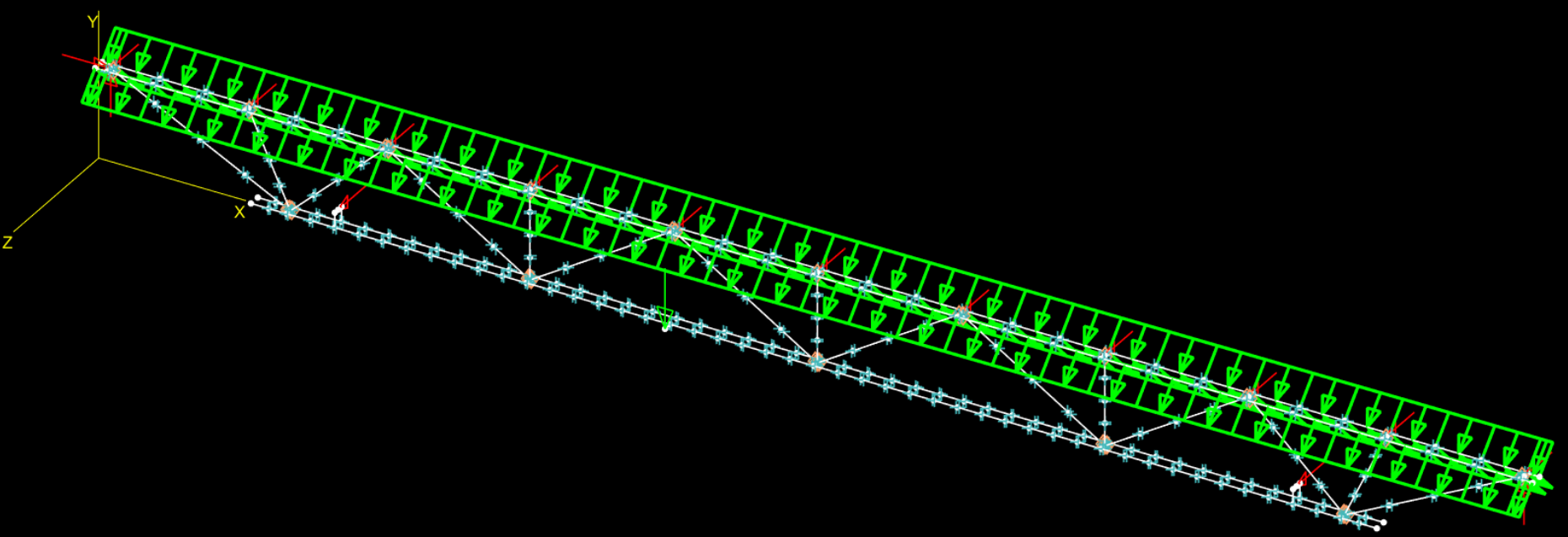

The image shows a 3D finite element model of a joist structure. The structure is a long, narrow beam with a cross-section of a joist. It is oriented along the X-axis. A distributed load is applied to the top surface of the joist, represented by a series of green downward-pointing arrows. The structure is supported at both ends. The model is displayed in a 3D perspective view with a coordinate system (X, Y, Z) shown. The X-axis is horizontal, the Y-axis is vertical, and the Z-axis is depth. The structure is colored in shades of blue and green. The load is represented by a series of green downward-pointing arrows. The structure is supported at both ends. The model is displayed in a 3D perspective view with a coordinate system (X, Y, Z) shown. The X-axis is horizontal, the Y-axis is vertical, and the Z-axis is depth. The structure is colored in shades of blue and green. The load is represented by a series of green downward-pointing arrows.



Second-Order Elastic Static Analysis Status: **Incr # 10, Applied Load Ratio = 1.000 --> Success: Analysis Complete**

Solution Type: Predictor-Corrector Incr Size: 0.1 Max. # of Incrs: 10 Max. Appl. Ratio: 1

Analysis Type: Space Frame [Kff] Start New Apply Cancel



Eccentrically Loaded Joist Elastic Results

- 1) From the **Results** menu select **Node Displacements**.
- 2) At the bottom menu bar, click on the **Apply** button.
- 3) On the undeflected shape, click on the midspan node of interest, node **173**, to see how the change to the midspan deflection from the eccentric load. 
- 4) On the undeflected shape, click on the node of the bottom chord attached to the eccentric loading arm, node **167**, to see how the hanging load moved the chord. 

MASTAN2: C:\Users\SSIRL\Desktop\Joist.mat [17:27]

File View Geometry Properties Conditions Analysis Results

Node:	173	Disp X	-0.05	Disp Y	-0.6088	Disp Z	-0.02324	Status:	Success: Disp. at ALR = 1.0000
Displacements	Rot X	0.002139	Rot Y	-6.593e-05	Rot Z	0.0008512	(10) 1.000	Apply	Cancel



MASTAN2: C:\Users\SSIRL\Desktop\Joist.mat [17:27]

File View Geometry Properties Conditions Analysis Results

Node:	167	Disp X	-0.06565	Disp Y	-0.6611	Disp Z	-0.0004378	Status:	Success: Disp. at ALR = 1.0000
Displacements	Rot X	0.1266	Rot Y	-1.392e-05	Rot Z	-0.002558	(10) 1.000	Apply	Cancel





Stress Calculations

Using the results available within the MASTAN2 model, it is possible to calculate the internal stresses that the members are experiencing. Provided in this tutorial are the steps to pull the necessary values from MASTAN2 and the resulting stresses.

Additional details on the necessary calculations are available in the “Pour Stop” tutorial.



Getting Internal Forces

- 1) From the **Results** menu select **Element Forces**.
- 2) On the undeflected shape, click on the midspan element of interest, element **198**, and the internal forces are provided in the bottom menu bar. These are the forces at the start of the member and the middle of the beam. 
- 3) These forces will be used to calculate the stresses at the middle of the beam.
- 4) At the bottom menu bar, drag the slider in the over left-hand corner until the position indicator just to the right displays **1.00L**.
- 5) Click on the **Apply** button. These are the forces at the end of the member. 
- 6) From this position, the bimoment is required to appropriately divide the longitudinal moment into the standard twisting and warping components for stress calculations.
- 7) Repeat these steps to get the internal forces in element **192**. This is where the larger negative moment on the bottom chord now occurs.

The forces at the start: 

The forces at the end: 



MASTAN2: C:\Users\SSIRL\Desktop\Joist.mat [17:27]

File View Geometry Properties Conditions Analysis Results

The image shows a 3D finite element model of a joist structure. The structure is represented by a series of nodes (small blue spheres) connected by elements (thin lines). A distributed load is applied to the top surface of the joist, indicated by a grid of green downward-pointing arrows. A 3D coordinate system is shown in the lower-left corner, with the X-axis pointing right, the Y-axis pointing up, and the Z-axis pointing out of the page. The model is displayed against a black background.

El #	198	N167:N168	P	5685	Vy	-26.17	Vz	22.4	(10) 1.000	Success: El Forces at ALR = 1.0000
		0.00L	Tx		-79.99	My	-677.4	Mz	245.4	B -46.63

Apply Cancel



MASTAN2: C:\Users\SSIRL\Desktop\Joist.mat [17:27]

File View Geometry Properties Conditions Analysis Results

The image shows a 3D finite element model of a joist structure. The structure is represented by a series of nodes (small blue spheres) connected by elements (thin lines). A distributed load is applied to the top surface of the joist, indicated by a grid of green downward-pointing arrows. A 3D coordinate system is shown in the lower-left corner, with the X-axis pointing right, the Y-axis pointing up, and the Z-axis pointing out of the page. The model is displayed against a black background.

El #	198	N167:N168	P	5685	Vy	-26.17	Vz	22.4	(10) 1.000	Success: El Forces at ALR = 1.0000	
		1.00L	Tx	-79.87	My	-533.5	Mz	149.7	B	-6.049	Apply Cancel



MASTAN2: C:\Users\SSIRL\Desktop\Joist.mat

File View Geometry Properties Conditions Analysis Results

El #	192	N161:N162	P	5685	Vy	20.36	Vz	-11.76	(10) 1.000	Success: El Forces at ALR = 1.0000			
<		>	0.00L	Tx	68.46	My	38.74	Mz	-160.8	B	22.58	Apply	Cancel



MASTAN2: C:\Users\SSIRL\Desktop\Joist.mat [17:27]

File View Geometry Properties Conditions Analysis Results

The image shows a 3D finite element model of a joist structure. The structure is represented by a series of nodes (small blue spheres) connected by elements (thin lines). A distributed load is applied to the top surface of the joist, indicated by a series of green downward-pointing arrows. A coordinate system is shown in the lower-left corner, with the X-axis pointing along the length of the joist, the Y-axis pointing upwards, and the Z-axis pointing outwards. The entire model is enclosed in a green wireframe box.

El #	192	N161:N162	P	5685	Vy	20.36	Vz	-11.76	(10) 1.000	Success: El Forces at ALR = 1.0000
		1.00L	Tx	68.43	My	-58.5	Mz	-79.99	B	3.234

Apply Cancel



Stress Calculation Results

The resulting stresses are available for the locations identified on the sketch. The forces are calculated immediately after the web connection node and after the point load.

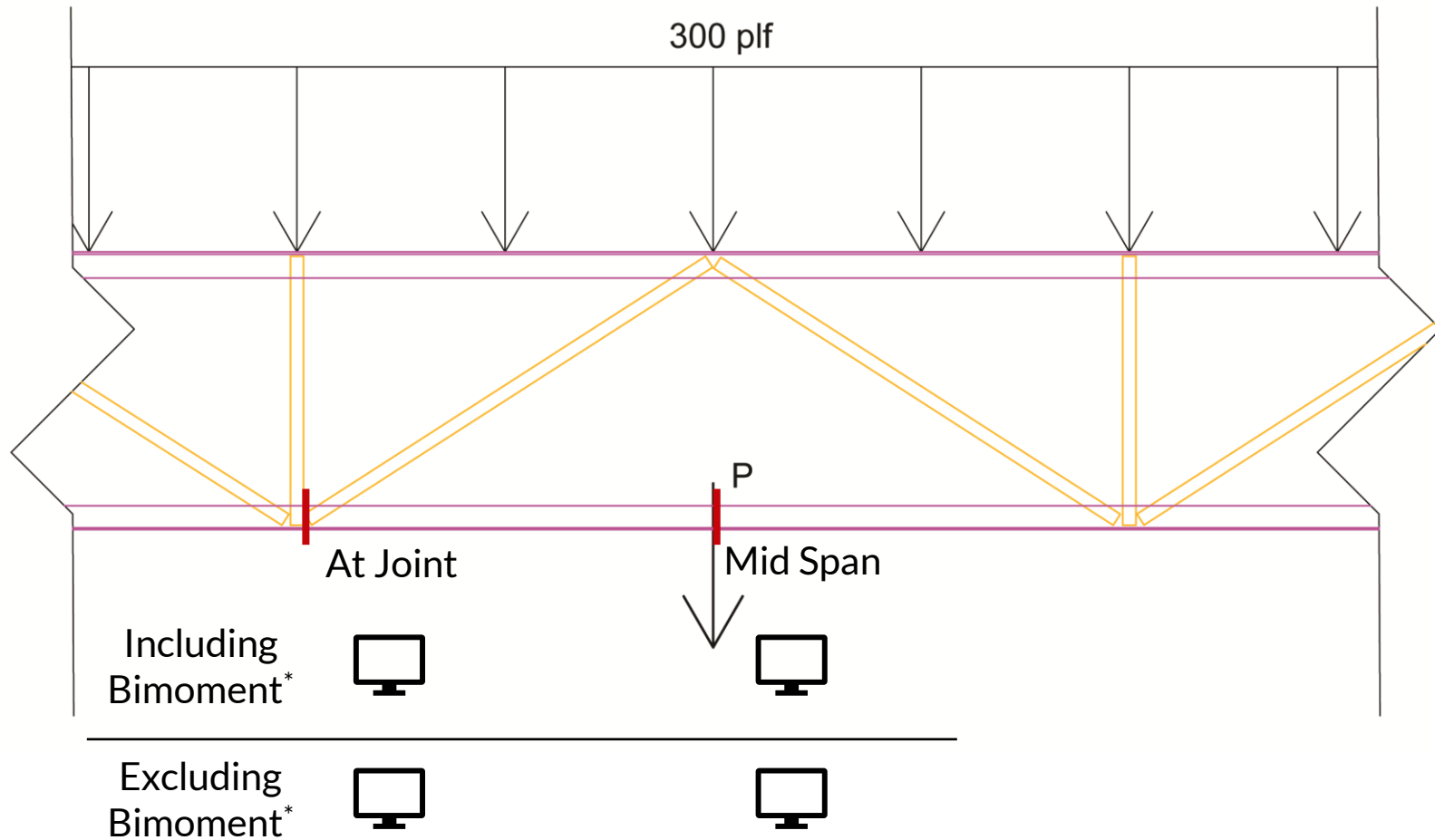

* Numerically bimoment exists in the model because the warping constant, C_w , is non-zero. Additional meshing of the model would refine the distribution of bimoment, but bimoment would still exist locally in the model at applied torque or supports and rapidly decrease to approximately zero along the majority of the length of the bottom chord. Since the evaluation of angles would often exclude the effects of warping, the internal stresses are provided having been calculated using the forces observed in this model including and excluding the bimoment values.



Stresses at Joint including Bimoment

Normal Stresses (ksi)

Red - Tension, Blue - Compression

Diagram not shown: From axial force, P - Uniform 19.00 ksi tension

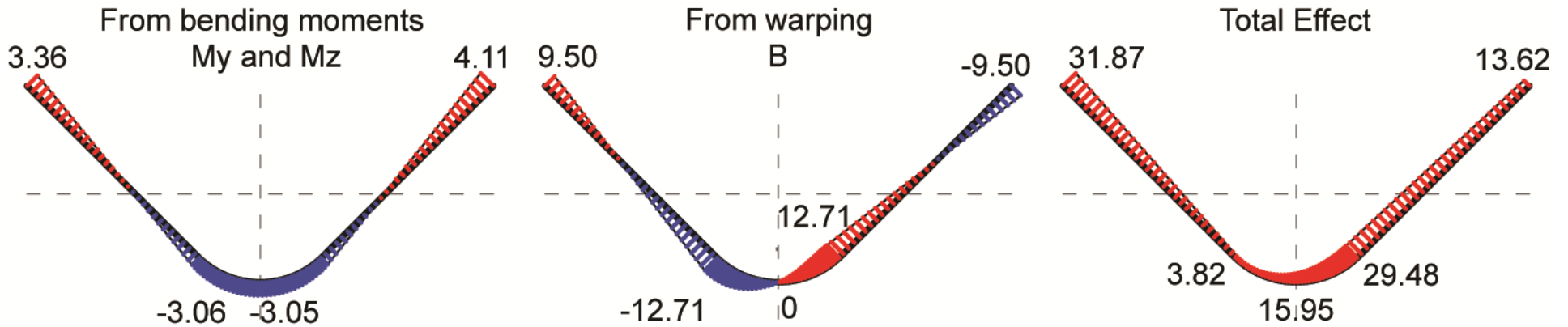

Shear Stresses (ksi)

Red - To the right, Blue - To the left

Diagram not shown: From torsional moment, T_T - Variable across thickness ± 6.04 ksi

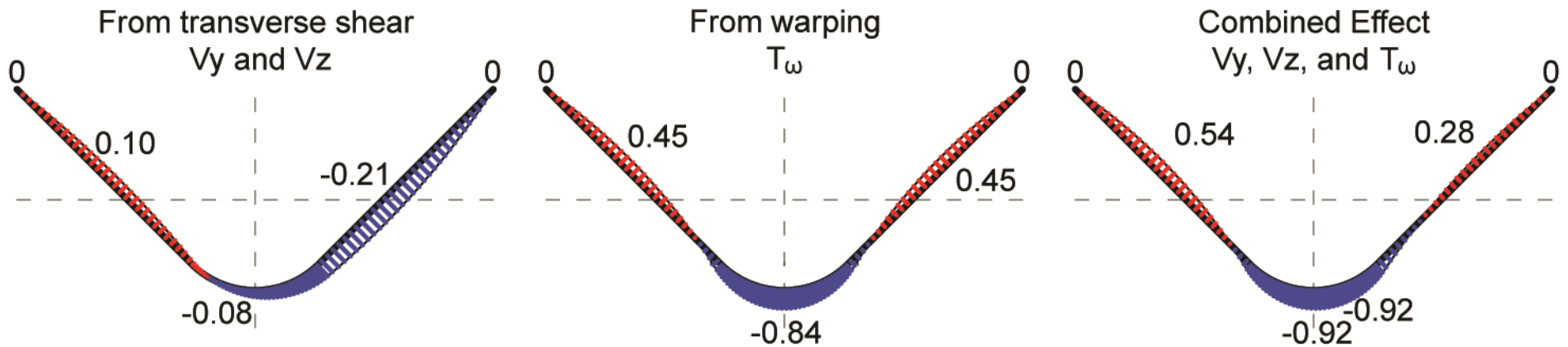

Stresses at Joint excluding Bimoment

Normal Stresses (ksi)
Red - Tension, Blue - Compression

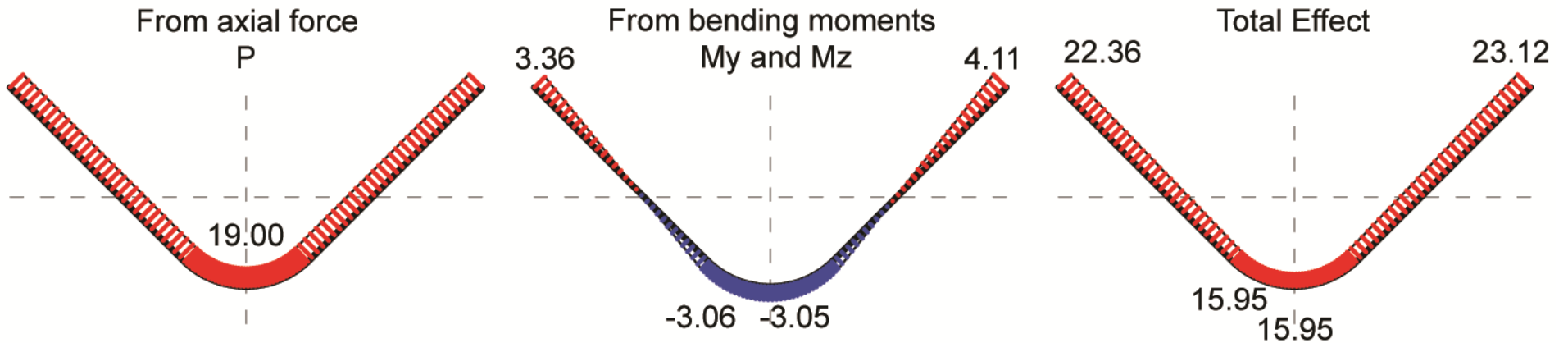

Shear Stresses (ksi)
Red - To the right, Blue - To the left

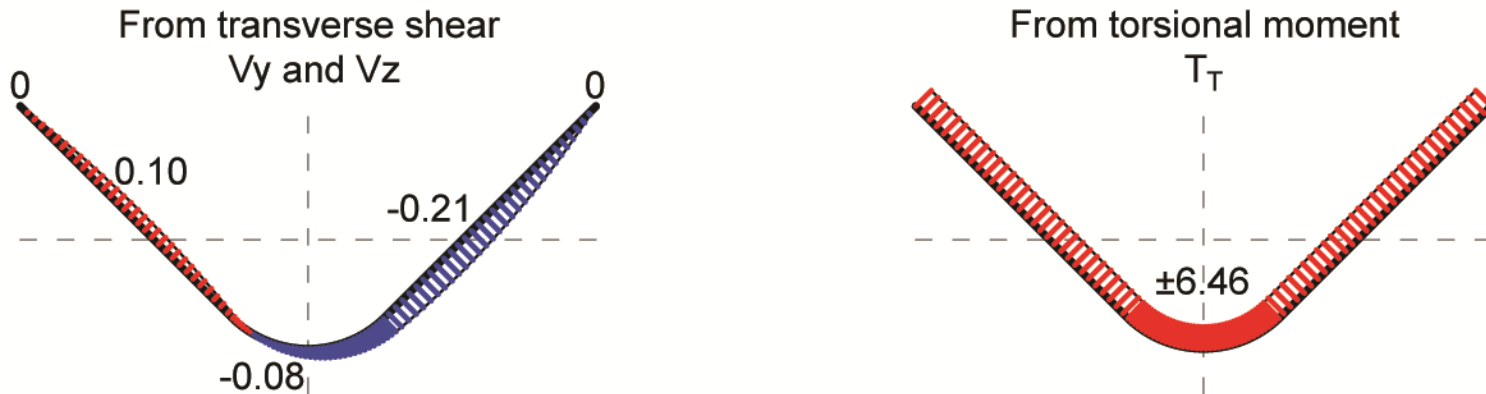

Stresses at Midspan including Bimoment

Normal Stresses (ksi)

Red - Tension, Blue - Compression

Diagram not shown: From axial force, P - Uniform 19.00 ksi tension

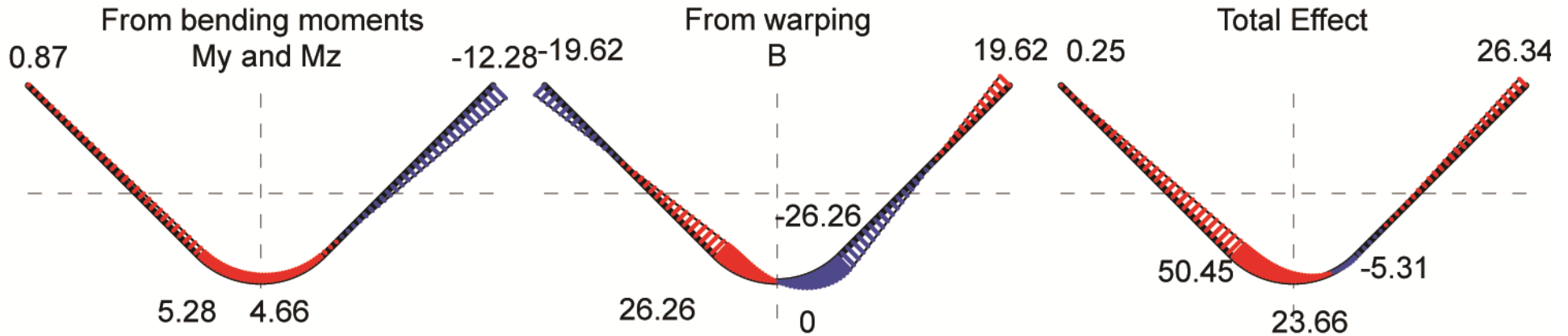

Shear Stresses (ksi)

Red - To the right, Blue - To the left

Diagram not shown: From torsional moment, T_T - Variable across thickness ± 7.03 ksi

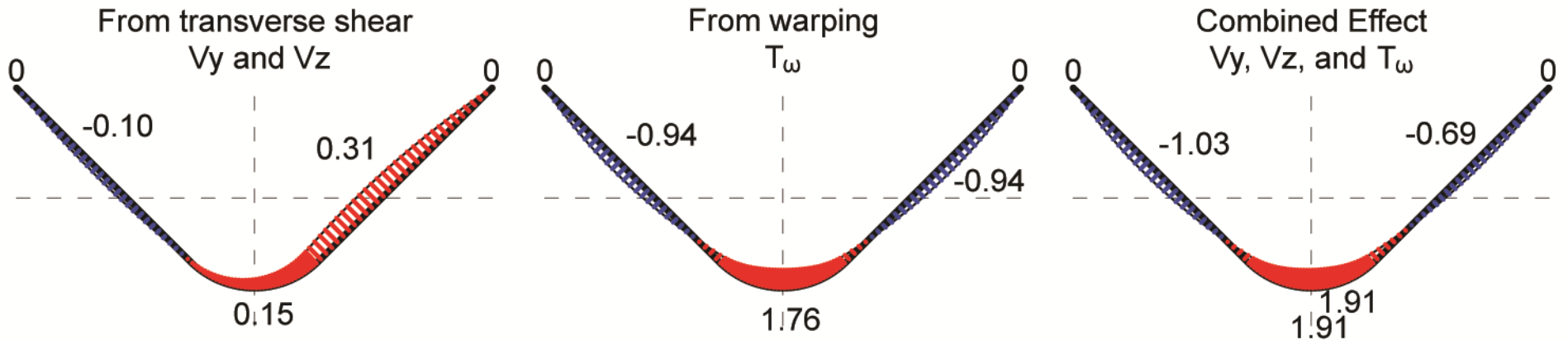

Stresses at Midspan excluding Bimoment

Normal Stresses (ksi)
Red - Tension, Blue - Compression

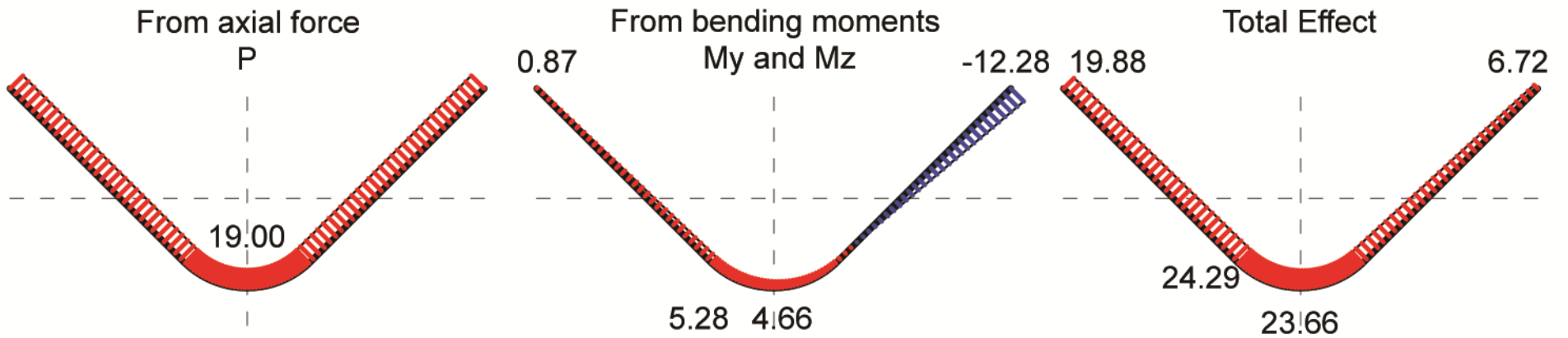

Shear Stresses (ksi)
Red - To the right, Blue - To the left

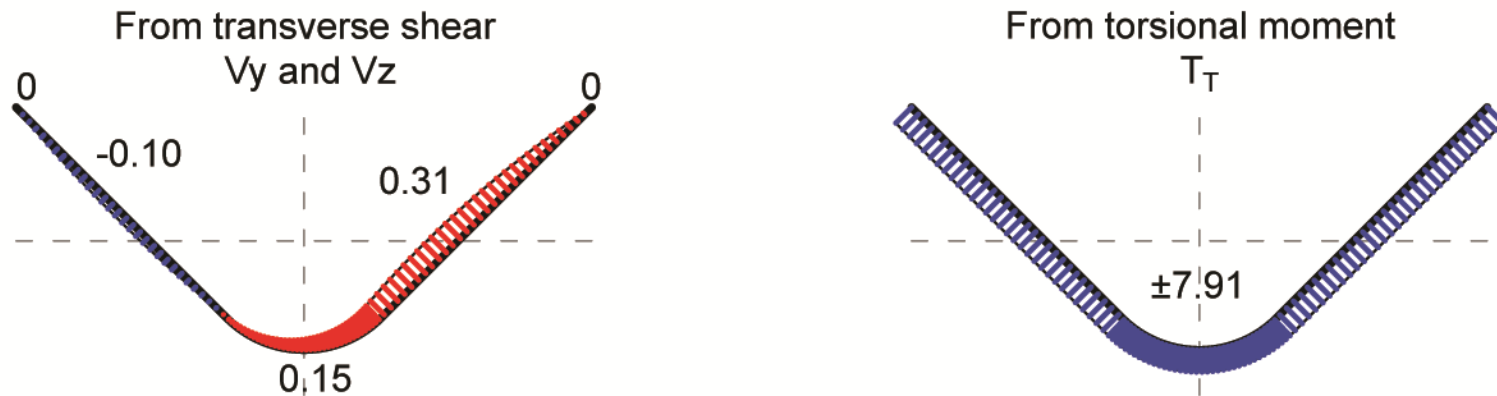

This completes the tutorial.



**American
Iron and Steel
Institute**

25 Massachusetts Avenue, NW
Suite 800
Washington, DC 20001
www.steel.org

