

# Shear Wall Values for Light Weight Steel Framing

RESEARCH REPORT RP96-1

1996

REVISION 2007



American Iron and Steel Institute



Steel Framing Alliance™

*Steel. The Better Builder.*

## **DISCLAIMER**

The material contained herein has been developed by researchers based on their research findings and is for general information only. The information in it should not be used without first securing competent advice with respect to its suitability for any given application. The publication of the information is not intended as a representation or warranty on the part of the American Iron and Steel Institute, Steel Framing Alliance, or of any other person named herein, that the information is suitable for any general or particular use or of freedom from infringement of any patent or patents. Anyone making use of the information assumes all liability arising from such use.

## **PREFACE**

This report presents the results of monotonic and cyclic tests of 42 full-size, cold-formed steel-framed shear walls sheathed with plywood, oriented strand board (OSB) and gypsum wallboard (GWB).

The findings provided a basis for continued research and development efforts, leading to the establishment of provisions for cold-formed steel-framed Type I shear walls.

Research Team  
Steel Framing Alliance



***Light Gauge Steel Research Group***  
Department of Civil Engineering  
Santa Clara University, Santa Clara, CA 95053

## **Shear Wall Values for Light Weight Steel Framing**

Report No.: LGSRG-3-96

*(previously released as "Design Values for Light Gauge Steel Framed Shear Walls" Report No. LGSRG-1-96)*

by  
Hoang Nguyen and Georgi Hall  
(Research Assistants)

Reynaud Serrette  
(Project Director)

February 29, 1996

An Applied Research Program  
Sponsored by: American Iron and Steel Institute

## Table of Contents

List of Tables .....	ii
List of Figures .....	iii
1.0 Introduction .....	1
2.0 Scope .....	1
3.0 Test Program and Setup .....	2
4.0 Instrumentation .....	3
5.0 Behavior and Test Results .....	3
6.0 Discussion of Test Results .....	4
7.0 Interpretation of Test Data .....	6
7.1 Static Test Data .....	6
7.2 Cyclic Test Data .....	6
8.0 Conclusion .....	7
9.0 Acknowledgement .....	8
Appendix A1 .....	22
Appendix A2 .....	28
Appendix A3 .....	37
Appendix B .....	54

## List of Tables

Table 1 Phase 1 test program .....	9
Table 2 Phase 2 test program .....	10
Table 3 Phase 3 test program .....	11
Table 4 Phase 1 test results .....	12
Table 5 Phase 2 test results .....	13
Table 6 Phase 3 test results .....	14

## List of Figures

Figure 1 8 ft. x 8 ft. and 4 ft. x 8 ft. walls .....	15
Figure 2 Overall test setup .....	16
Figure 3 Cyclic test protocols .....	18
Figure 4 Instrumentation for static and cyclic tests .....	19
Figure 5 Basic mode of failure--plywood and OSB wallss .....	20
Figure 6 Typical hysteretic loops for cyclically tested wall .....	21

# Shear Wall Values for Light Weight Steel Framing

Light Gauge Steel Research Group  
Santa Clara University, Santa Clara, CA 95053

## 1.0 Introduction

The purpose of this experimental research program was to investigate the behavior of light gauge steel framed shear walls sheathed with plywood, oriented strand board (OSB), and gypsum wallboard (GWB). To accomplish this a total of 48 tests were completed, 42 of which are reported here. The overall scope of the program is described in the following section.

## 2.0 Scope

The test program was divided into three phases (1, 2, and 3) based on three objectives that were set by AISI's Shear Wall Task Committee. The main objective of Phase 1 of the program was to investigate the differences in static behavior of plywood (15/32 in. APA rated 4-ply plywood sheathing) and OSB (7/16 in. APA rated OSB sheathing) shear walls. Four aspects of behavior were evaluated:

- (i) Static strength of 8 ft. x 8 ft. OSB vs. plywood walls--panels on one side of the wall (parallel to framing),
- (ii) Behavior of the weaker of OSB and plywood with panels parallel and perpendicular to framing--panels on one side of the wall,
- (iii) Behavior of the weaker of OSB and plywood walls with studs framed at 24 in. and 16 in. on center--panels on one side of the wall, and
- (iv) Behavior of 8 ft. x 8 ft. and 4 ft. x 8 ft. walls of the same panel (the weaker of OSB and plywood)--panels on one side of the wall.

Using the weaker (in shear) of the OSB and plywood panels, the second phase (Phase 2) of the test program was initiated. Phase 2 included static tests on OSB (7/16 in. OSB was found to be weaker than the 15/32 in. 4-ply plywood) and GWB walls. This phase focused on:

- (i) Behavior of OSB walls with dense fastener schedules--panels on one side of the wall,
- (ii) Behavior of wall panels with OSB one side and GWB panels on the other side, and
- (iii) Behavior of walls with GWB panels on both sides.

The final phase of the test program, Phase 3, included cyclic testing of OSB and plywood 4 ft. x 8 ft. walls with panels parallel to framing (one side of the wall sheathed). Walls with different fastener schedules, covering all fastener schedules currently allowed in the 1994 UBC, 1993 NBC, and the 1994 SBC, were tested.

For each wall configuration evaluated, two tests were performed. This provided a minimum level of reliability/validity of the test data. Details of the three phases of the test program and the test setup used are discussed in the following sections.



### 3.0 Test Program and Setup

Thirty-two of the 42 walls included in this report were sheathed with panels on one side of the wall. Six walls were sheathed with OSB on one side and GWB on the other side, and 4 walls were sheathed with GWB on both sides.

In accordance with the new prescriptive recommendations for cold-formed steel framing which is under development by the National Association of Home Builders (NAHB), the materials used in this test program are summarized below:

- *Studs*: 20 gauge 3.50 in. C-stud with 1.625 in. flange and 0.375 in. lip, fabricated from ASTM A446 Grade A (33 ksi) steel—all studs were mill certified (manufacturer is a member of the Metal Stud Manufacturers Association, MSMA)
- *Track*: 20 gauge 3.5 in. C-track with 1.25 in. flange, fabricated from ASTM A446 Grade A (33 ksi) steel—all tracks were mill certified (manufacturer is a member of the Metal Stud Manufacturers Association, MSMA)
- *Framing screws*: No. 8 x 0.5 in. Wafer (Modified Truss) Head self-drill.
- *Hold-downs (tie-down) screws*: No. 10 x 1 in. Hex Washer Head self-drill (in a few cases—three tests—No. 10 x 0.625 in. Pancake Head self-drill screws were used).
- *Plywood and OSB screws*: No. 8 x 1 in. Flat Head w/counter sinking nibs under the head, type 17 point, coarse high thread.
- *Strap (horizontal strapping)*: 1.5 in. 20 gauge (same material properties as stud and track).
- *20 gauge*: 0.0346 in. (design thickness)

The basic steel framing for the 8 ft. x 8 ft. and 4 ft. x 8 ft. walls are shown in Figure 1. At the ends of the wall, double studs (back-to-back) were used to prevent local and flexural buckling in the chords. Figure 1 also shows the position of the anchor (shear) and the hold-down bolts. The shear bolts adjacent to the hold-downs were located in accordance with Section 403.1 of the 1995 CABO One & Two Family Dwelling Code (not more than 12 in. from the corner). For the shear wall to develop its full capacity based on the sheathing, the hold-down and anchor bolts were over designed. The average maximum capacity for the hold-downs used in all the tests was 21,197 lb. (based on literature provided by the manufacturer).

Figure 2 shows that the loading plate was bolted to the top of the wall in the static tests and for the cyclic tests the loading plate was screw fastened to the top track. Both methods of attaching the loading plate provide a mechanism for distributing the applied load along the top of the wall. The bottom track of the wall assembly was attached to a fixed base which in turn was attached to

a structural floor. A 3.5 in. by 0.5 in. spacer plate (the full length of the wall) was installed between the bottom track and the fixed base. The spacer plate allowed the panel to displace relative to the framing without bearing on the base of the test frame (before failure). At the top of the wall a similar spacer was used between the loading plate and the track.

The test protocol for the static tests involved displacing the top of the wall at a rate of approximately 0.3 in. per minute. To evaluate the permanent set at 0.5 in. (approximately 0.5% of the wall height) and 1.5 in. ( $3R_w/8$  times 0.5 in. with  $R_w = 8$ ) the walls (in the static tests) were unloaded at these displacements. For the cyclic tests, the sequential phase displacement protocol recommended by the Ad Hoc Committee on Testing Standards for Structural Systems and Components--Structural Engineers Association of Southern California--was used. The walls were cycled at 1.5 seconds per cycle (0.67 Hz) and the test protocol is illustrated in Figure 3.

In all the tests described above, the edge distance for the installed fasteners was 3/8 in. ( $\pm 1/16$  in.) from the edge of the panel.

#### 4.0 Instrumentation

The instrumentation for the static and cyclic tests is shown in Figure 4. In the static tests, three displacements--top of wall lateral displacement (in-plane shear displacement), uplift, and base slip--and one load (applied lateral load) were measured and recorded electronically using a Helios Plus data acquisition system. Measurements in the static test were taken every 2 seconds.

In addition to the instrumentation used in the static tests, the wall uplift was measured on both ends of the wall in the cyclic tests. The hold-down loads were also monitored and recorded. The top of wall lateral deflection was measured directly at the loading ram. A special purpose data acquisition and control system monitored the position of the wall 300 times a second and recorded data at a rate of 50 times per second. Each recording included wall displacements and loads.

#### 5.0 Behavior and Test Results

The overall behavior of the plywood and OSB panel assemblies was practically identical (except for the effects of load reversal in the cyclic tests) for both the static and cyclic tests. In general, racking of the wall resulted in the screw fasteners rocking (tilting) about the plane of the stud flange. Rocking resulted in the head and shank of the screw pressing into the panel and bending of the flange material immediately around the screw. This behavior resulted in permanent lateral deflection of the wall and appears to be the main source of energy dissipation in the walls. As the lateral displacement of the wall increased, the panel pulled over the screw heads and became unzipped, as shown in Figure 5. The wall responded to unzipping by a sudden drop in load carrying capacity. An examination of the walls after each test revealed that except for three screws (in the entire test program), no screws pulled out of the stud flanges. It was also observed that none of the screws suffered any significant bending and none of the screws fractured from fatigue.

In the static tests, walls with panels perpendicular to framing exhibited a larger resistance than similar walls with panels parallel to framing. The statically tested gypsum sheathed wall assemblies were less stiff than the statically test wood panel walls, but the loss of capacity after reaching the maximum load appeared to be more gradual than in the wood panel walls. This is probably due to the fact that the gypsum panels did not unzip. The mode of failure in the gypsum sheathed walls resulted from the edges of the board breaking (wedge pattern) and the maximum load for these walls occurred at a displacement of approximately 1.0 in. Otherwise, as in the wood panel tests, prior to failure, the fasteners were observed to tilt about the plane of the stud flange.

For the walls with OSB panels on one side and GWB on the other side, the failure of each panel was similar to that described above. The overall strength of the wall was determined primarily by the wood panel—depending on the wood panel fastener schedule. For panels with relatively sparse fastener schedules (6 in./12 in.), the effect of GWB was evident both in the strength and stiffness of the wall. For dense schedules (3 in./12 in. and 2 in./12 in.), however, the GWB panel added little strength and stiffness to the wall.

For all walls with screw schedules of 3 in./12 in. and 2 in./12 in., the chord studs crippled (crushed) locally either at the position of web cut-out above the hold-down or at the hold-down. In both the static and cyclic tests, crippling advanced the pull-over behavior of the panels. Crippling typically initiated in the non-sheathed flange of the chord stud member. The walls with 2 in./12 in. schedules also exhibited local/distortional buckling in the flange of the studs adjacent to the compression chord.

Test results for the three phases of the test program are presented in Tables 4, 5, and 6. In Table 6, cyclic test results the nominal load capacity is defined at the last set on stable hysteretic loops. The recommended capacity is then taken as the average of the negative and positive strengths using the lowest strength curve at the specified set of hysteretic loops, see Figure 6. Plots of load versus total top of wall lateral displacement are given in Appendices A1, A2, and A3 for Phases 1, 2, and 3 of the test program, respectively, and typical modes of failure are given in Appendix B.

## 6.0 Discussion of Test Results

A comparison of the static test data for 8 ft. x 8 ft. plywood and OSB walls (fasteners at 6 in./12 in.), with panels parallel to framing, gave the following results:

- the nominal capacity (lb/ft.) of the plywood wall was approximately 17% greater than that of the 7/16 in. OSB wall
- the plywood walls exhibited much larger deformation capacity at the maximum load (approximately 2.40 in.) compared to the OSB wall (approximately 1.5 in.)

- OSB walls with panels installed perpendicular to framing (horizontally joint blocked) has a higher load and deformation capacity compared to the wall with panels parallel to framing

- the 4 ft. x 8 ft. OSB walls with panels perpendicular to framing gave approximately the same capacity (lb/ft.) as the 8 ft. x 8 ft. walls with identical panel orientation (the same behavior can be expected for panels parallel to framing).

For the static 4 ft. x 8 ft. OSB tests with panels parallel to framing and fastener schedules of 4 in./12 in., 3 in./12 in., and 2 in./12 in., normalization of the average maximum load values with respect to the average maximum load for OSB-1A2 and OSB-1A3 (6 in./12 in.) gave the following ratios:

- 4 in. perimeter spacing versus 6 in. perimeter spacing: 1.54
- 3 in. perimeter spacing versus 6 in. perimeter spacing: 1.91
- 2 in. perimeter spacing versus 6 in. perimeter spacing: 2.10

These values are roughly consistent to the increases that are currently recommended for plywood shear walls over wood framing. Higher ratios can be expected for the 3 in./12 in. and 2 in./12 in. walls when the chord studs are prevented from crippling (crushing).

When the 4 ft. x 8 ft. OSB walls were sheathed with 1/2 GWB on the other side, an increase in capacity (lb/ft.) of the wall was most evident in the walls with 6 in./12 in. fastener schedules (in the OSB). For the other fastener schedules there was no significant increase in capacity due to the presence of the GWB panel. The increase in maximum strength due to the addition of the GWB to the OSB wall is summarized below:

- 6 in./12 in. spacing on OSB and 7 in./7 in. spacing on GWB vs. 6 in./12 in. spacing on OSB without GWB: 1.33
- 4 in./12 in. spacing on OSB and 7 in./7 in. spacing on GWB vs. 4 in./12 in. spacing on OSB without GWB: 1.11
- 2 in./12 in. spacing on OSB and 7 in./7 in. spacing on GWB vs. 2 in./12 in. spacing on OSB without GWB: 0.98 (crushing in chord studs)

As expected, the maximum capacities of the 8 ft. x 8 ft. GWB walls and the corresponding displacements were relatively low compared the plywood and OSB walls. The ratio of maximum load capacity for the 4 in./4 in. wall with the 7 in./7 in. wall was 1.46. As Table 5 shows, the 7 in./7 in. wall reached its maximum capacity at approximately 0.86 in. while the 4 in./4 in. wall reached its maximum capacity at approximately 0.96 in..

In the cyclic tests, for a given screw schedule, the plywood walls had generally higher load capacities (using either of the two measures given in Table 6) than corresponding OSB walls. The difference in capacities, appears to be approximately 10% (neglecting the walls with the 2 in./12 in. screw schedule):

- plywood vs. OSB with screws at 6 in./12 in.: 1.11
- plywood vs. OSB with screws at 4 in./12 in.: 1.08
- plywood vs. OSB with screws at 3 in./12 in.: 1.15
- plywood vs. OSB with screws at 2 in./12 in.: 0.96 (early crushing/crippling of chord studs)

A comparison of the average maximum capacities from the static 4 ft. x 8 ft. OSB wall tests with corresponding values from the cyclic tests (using values from the last stable loops), for the 6 in./12 in. (using the 8 ft. x 8 ft. test result), 4 in./12 in., 3 in./12 in., and 2 in./12 in. fastener schedules, gives the following ratios for static versus cyclic capacities:

- 6 in./12 in.: 1.23
- 4 in./12 in.: 1.55
- 3 in./12 in.: 1.36
- 2 in./12 in.: 1.13

The low values of 1.36 and 1.13 for the 3 in./12 in. and 2 in./12 in. walls are probably due to crippling in the chord studs. Higher ratio should be obtained with adequately designed chord studs.

## 7.0 Interpretation of Test Data

Ideally, three limit states of behavior for the wall assemblies should be considered when establishing the nominal design strength of wall: maximum strength, stiffness (displacement), and damage. The damage limit state is difficult to interpret since there are no established procedures for doing so. Thus, in this project no attempt was made to characterize load capacity based on damage.

### 7.1 Static Test Data

Stiffness has generally been addressed on the basis of a limit on the lateral displacement of the wall. In the 1994 UBC (by reference to the 1990 SEAOC Blue Book), the limit inelastic lateral displacement of the wall may be approximated as  $3R_w/8(\Delta_{allowable})$ , where  $\Delta_{allowable}$  (elastic displacement) is usually taken as 0.5% of the story height. For the plywood shear wall  $R_w$  may be taken as 8 and for other permissible walls  $R_w$  may be taken as 6. Comparing the nominal strength at the limit inelastic displacement with the maximum strength, an appropriate design maximum load can be defined and a corresponding factor of safety and resistance factor assigned to the assembly.

### 7.2 Cyclic Test Data

Interpretation of the cyclic test data is more complex than static data since the measured response depends on the test protocol (spectrum), and the shape and size of the hysteretic loops. In the tests conducted in this investigation, the basic test protocol recommended by the Ad Hoc

Committee on Testing Standards for Structural Systems and Components (Structural Engineers Association of Southern California--SEAOSC) was used.

Results from the cyclic tests showed a few basic trends:

- severe pinching of the hysteresis loops
- strength degradation at a given level of displacement leading ultimately to unstable hysteretic loops
- stiffness degradation with increasing lateral displacement (back-bone curve)

Some interpretation of these trends may be used to establish the design loads based on cyclic tests. The following suggestions are offered for estimating the design load:

- load at which pinching becomes markedly evident (represents a change in wall stiffness)
- load at the last set of stable hysteretic loops (stable loops being defined as consecutive cycles at a given level of displacement where the strength does not change by more than 5% between consecutive cycles at that displacement)—*use the strength given by the lowest hysteretic loop*
- interpret the back-bone curve as an equivalent static curve (back-bone based on the lowest strength loop at a cycle displacement). *Note: recent recommendations from SEAOSC suggest using highest strength hysteretic curves to develop the back-bone curve*
- compute the energy dissipated and limit the capacity based on the energy demand of the wall.

## 8.0 Conclusion

The results from static and cyclic (pseudo-dynamic) in-plane shear tests for light gauge steel framing are presented. The results are given in terms of strength and stiffness (deflection) of the wall. Methods for interpretation of the test results are also discussed.

Based on the tests, the following general conclusions can be made:

### *Static tests:*

- 4 ft. x 8 ft. walls have the same capacity (lb/ft.) as the 8 ft. x 8 ft., provided the panels have the same orientation--parallel or perpendicular to framing
- blocked walls with panels perpendicular to framing have a higher capacity (lb/ft.) than walls with panels parallel to framing
- the maximum strength of the 7/16 in. OSB wall is less than that of the 15/32 in. plywood wall (difference appears to be due primarily to the composition of the panels)
- tighter screw schedules produce significant increases in shear capacity and the increases are comparable to those currently specified for walls using wood framing--with tighter schedules more attention must be given to sizing of chords studs to develop the nominal capacity of the wall

- the shear capacity of the GWB walls were low as expected and the maximum capacity of the walls occurred before a lateral displacement of 1.50 in.
- for walls with tight fastener schedules (4 in./12 in. to 2 in./12 in.) and wood panels on one side and GWB (fastener schedule of 7 in./7 in.) on the other side, there was no significant increase in capacity over the walls with the wood panels on one side only

*Cyclic tests:*

- although the measured maximum resistance of the plywood walls was higher than that of the OSB walls, in general, the differences between the values do not appear to be significant (approximately 10%)
- as in the static tests, the engineer must pay attention to the design of chords studs for panels with tight screws schedules (3 in./12 in. and 2 in./12 in.)
- depending on the fastener schedule, the static strength of the wood paneled wall may be as much as 55% more than the corresponding cyclic strength

## 9.0 Acknowledgments

The work reported here is a result of support from many individuals, companies, and organizations. Funding and general guidance for the project was provided by AISI, particularly Roger Brockenbrough (chair of AISI Shear Wall Task committee), Hank Martin, and Steve Walker. LGSEA (Light Gauge Steel Engineers Association) provided considerable input and commentary on the development of the test program and interpretation of the test results. Commentary on the test results by the Structural Engineers Association of Northern California is also sincerely appreciated. Assistance with fabrication of the wall assemblies was provided through Mike Quiroz of CCCC (Carpenters, Contractors Cooperative Committee), Inc. The facilities for cyclic testing were provided by Simpson Strong-Tie Company, Inc. The support of John Rose (APA), Mark Aucoin (International Paper, Inc.), Marge Spencer (Compass International), Jeff Wardley (Grabber), Bob Gregg (Simpson Strong-Tie Company, Inc.), John McNulty (Angeles Metals), United States Gypsum (through Mike Quiroz), and Black and Decker (through Mike Quiroz) is sincerely and most gratefully appreciated. The technical assistance provided by Jerry Eveland (civil engineering lab manager, Santa Clara University) and students assistants Mark Chase, Victor Lopez, Luong Do, and Miranda Cummings is also gratefully appreciated.

Table 1 Phase 1 test program

Test Specimen	Description of wall specimen	Fastener Schedule	Wall Dimensions
PLY-1A6 PLY-1A7	15/32" 4-ply plywood APA rated sheathing w/panels on one side--parallel to framing (framing at 24 in. o.c.)	6 in. / 12 in.	8 ft. x 8 ft.
OSB-1A2 OSB-1A3	7/16" OSB APA rated sheathing w/panels on one side--parallel to framing (framing at 24 in. o.c.)	6 in. / 12 in.	8 ft. x 8 ft.
OSB-1A5 OSB-1A6	7/16" OSB APA rated sheathing w/panels on one side--perpendicular to framing (framing at 24 in. o.c.)--1-1/2" 20 ga. strap at mid-height (horizontal joint)	6 in. / 12 in.	8 ft. x 8 ft.
OSB-1E1 OSB-1E2	7/16" OSB APA rated sheathing w/panels on one side--perpendicular to framing (framing at 24 in. o.c.)--1-1/2" 20 ga. strap at mid-height (horizontal joint)	6 in. / 12 in.	4 ft. x 8 ft.
OSB-1D1 OSB-1D2	7/16" OSB APA rated sheathing w/panels on one side--parallel to framing (framing at 16 in. o.c.)	6 in. / 12 in.	4 ft. x 8 ft.

Notes:  
 Studs and track are 3-1/2 in. 20 ga.--ASTM A446 Grade A (33 ksi) steel  
 Studs flange: 1-5/8 in.; stud lip: 3/8 in.; Track (runner) flange: 1-1/4 in.  
 Framing screws: No. 8 x 1/2 in. Wafer (Modified Truss) Head self-drill.  
 Hold-downs screws: No. 10 x 1 in. Hex Washer Head self-drill  
 Plywood and OSB screws: No. 8 x 1 in. Flat Head w/counter sinking nibs under the head, type 17 point, coarse high thread  
 Straps: 1-1/2" 20 ga. (same material properties as stud and track)  
 20 ga. = 0.0346 in. (design thickness)



Table 2 Phase 2 test program

Test Specimen	Description of wall specimen	Fastener Schedule	Wall Dimensions
OSB-ID3 OSB-ID4	7/16" OSB APA rated sheathing w/panels on one side--parallel to framing (framing at 24 in. o.c.)	4 in. / 12 in.	4 ft. x 8 ft.
OSB-ID5 OSB-ID6	same	3 in. / 12 in.	4 ft. x 8 ft.
OSB-ID7 OSB-ID8	same	2 in. / 12 in.	4 ft. x 8 ft.
OSB-IF1 OSB-IF2	7/16" OSB APA rated sheathing one side and 1/2" GWB other side--panels parallel to framing (framing at 24 in. o.c.)	6 in. / 12 in. 7 in. / 7 in.	4 ft. x 8 ft.
OSB-IF3 OSB-IF4	7/16" OSB APA rated sheathing one side and 1/2" GWB other side--panels parallel to framing (framing at 24 in. o.c.)	4 in. / 12 in. 7 in. / 7 in.	4 ft. x 8 ft.
OSB-IF5 OSB-IF6	7/16" OSB APA rated sheathing one side and 1/2" GWB other side--panels parallel to framing (framing at 24 in. o.c.)	2 in. / 12 in. 7 in. / 7 in.	4 ft. x 8 ft.
GWB-2A1 GWB-2A3	1/2" GWB both sides with panel perpendicular to framing and 1-1/2" lateral strap at mid-height (along horizontal joint)--framing at 24 in. o.c.	7 in. / 7 in.	8 ft. x 8 ft.
GWB-2A2 GWB-2A4	1/2" GWB both sides with panel perpendicular to framing and 1-1/2" lateral strap at mid-height (along horizontal joint)--framing at 24 in. o.c.	4 in. / 4 in.	8 ft. x 8 ft.

Notes:

Studs and track are 3-1/2 in. 20 ga.--ASTM A446 Grade A (33 ksi) steel  
 Studs flange: 1-5/8 in.; stud lip: 3/8 in.; Track (runner) flange: 1-1/4 in.  
 Framing screws: No. 8 x 1/2 in. Wafer (Modified Truss) Head self-drill.  
 Hold-downs screws: No. 10 x 1 in. Hex Washer Head self-drill  
 Plywood and OSB screws: No. 8 x 1 in. Flat Head w/counter sinking nibs under the head, type 17 point, coarse high thread  
 GWB and OSB screws: No. 6 x 1-1/4 in. Bugle Head, type "S" point  
 Straps: 1-1/2" 20 ga. (same material properties as stud and track)  
 20 ga. = 0.0346 in. (design thickness)

Table 3 Phase 3 test program

Test Specimen	Wall Description	Fastener Schedule	Wall Dimensions
AISI-OSB1 AISI-OSB2	7/16" OSB APA rated sheathing w/panels on one side--parallel to framing (framing at 24 in. o.c.)	6 in. / 12 in.	4 ft. x 8 ft.
AISI-OSB3 AISI-OSB4	same	4 in. / 12 in.	4 ft. x 8 ft.
AISI-OSB5 AISI-OSB6	same	3 in. / 12 in.	4 ft. x 8 ft.
AISI-OSB7 AISI-OSB8	same	2 in. / 12 in.	4 ft. x 8 ft.
AISI-PLY1 AISI-PLY2	15/32" plywood APA rated sheathing (40ply) w/panels one side--parallel to framing (framing at 24 in. o.c.)	6 in. / 12 in.	4 ft. x 8 ft.
AISI-PLY3 AISI-PLY4	same	4 in. / 12 in.	4 ft. x 8 ft.
AISI-PLY5 AISI-PLY6	same	3 in. / 12 in.	4 ft. x 8 ft.
AISI-PLY7 AISI-PLY8	same	2 in. / 12 in.	4 ft. x 8 ft.

Notes:  
 Studs and track are 3-1/2 in. 20 ga.--ASTM A446 Grade A (33 ksi) steel  
 Studs flange: 1-5/8 in.; stud lip: 3/8 in.; Track (runner) flange: 1-1/4 in.  
 Framing screws: No. 8 x 1/2 in. Wafer (Modified Truss) Head self-drill.  
 Hold-downs screws: No. 10 x 1 in. Hex Washer Head self-drill  
 Plywood and OSB screws: No. 8 x 1 in. Flat Head w/counter sinking nibs under the head, type 17 point, coarse high thread  
 20 ga. = 0.0346 in. (design thickness)

Table 4 Phase 1 test results

Test Specimen	Description of wall specimen	Maximum load capacity, lb/ft.	Displacement at max. load, in.	Load capacity at 1/2 in. deflection, lb/ft.	Load capacity at 1-1/2 in. deflection, lb/ft.
PLY-1A6 PLY-1A7	15/32" 4-ply plywood APA rated sheathing w/panels on one side--parallel to framing (framing at 24 in. o.c.--fasteners at 6"1/2"--8"x8' wall)	1038 1087	2.41 2.43	485 530	809 881
OSB-1A2 OSB-1A3	7/16" OSB APA rated sheathing w/panels on one side--parallel to framing (framing at 24 in. o.c.--fasteners at 6"1/2"--8"x8' wall)	931 891	1.50 1.47	573 612	931 881
OSB-1A5 OSB-1A6	7/16" OSB APA rated sheathing w/panels on one side--perpendicular to framing (framing at 24 in. o.c.--fasteners at 6"1/2"--8"x8' wall)--1-1/2" 20 ga. strap at mid-height (horizontal joint)	1033 989	2.19 1.94	556 574	939 915
OSB-1E1 OSB-1E2	7/16" OSB APA rated sheathing w/panels on one side--perpendicular to framing (framing at 24 in. o.c.--fasteners at 6"1/2"--4"x8' wall)--1-1/2" 20 ga. strap at mid-height (horizontal joint)	990 1061	2.38 2.77	468 428	798 765
OSB-1D1' OSB-1D2'	7/16" OSB APA rated sheathing w/panels on one side--parallel to framing (framing at 16 in. o.c.--fasteners at 6"1/2"--4"x8' wall)	846 875	1.50 1.50	437 386	846 875

' load cell reading erratic--load suspect (on the low side)

Table 5 Phase 2 test results

Test Specimen	Description of wall specimen	Maximum load capacity, lb/ft.	Displacement at max. load, in.	Load capacity at 1/2 in. deflection, lb/ft.	Load capacity at 1-1/2 in. deflection, lb/ft.
OSB-ID3 OSB-ID4	7/16" OSB APA rated sheathing w/panels on one side--parallel to framing (framing at 24 in. o.c.--fasteners at 4"/12"--4'x8' wall)	1473 1350	2.36 2.30	576 571	1197 1116
OSB-ID5 <sup>1</sup> OSB-ID6 <sup>1</sup>	same	1763 1709	2.30 1.86	675 758	1435 1514
OSB-ID7 <sup>1</sup> OSB-ID8 <sup>1</sup>	same	1933 1891	1.84 2.10	886 810	1786 1620
OSB-IF1 OSB-IF2	7/16" OSB APA rated sheathing one side and 1/2" GWB other side--panels parallel to framing (framing at 24 in. o.c.--fasteners at 6"/12" for OSB and 7"/7" for GWB--4'x8' wall)	1190 1243	2.25 2.23	664 586	1090 1076
OSB-IF3 OSB-IF4	7/16" OSB APA rated sheathing one side and 1/2" GWB other side--panels parallel to framing (framing at 24 in. o.c.--fasteners at 4"/12" for OSB and 7"/7" for GWB--4'x8' wall)	1516 1604	2.37 2.52	680 664	1296 1255
OSB-IF5 <sup>1</sup> OSB-IF6 <sup>1</sup>	7/16" OSB APA rated sheathing one side and 1/2" GWB other side--panels parallel to framing (framing at 24 in. o.c.--fasteners at 2"/12" for OSB and 7"/7" for GWB--4'x8' wall)	1918 1850	1.84 1.73	889 884	1731 1796
GWB-2A1 GWB-2A3	1/2" GWB both sides with panel perpendicular to framing and 1-1/2" lateral strap at mid-height--along horizontal joint (framing at 24 in. o.c.--fasteners at 7"/7"--8'x8' wall)	545 621	0.77 0.96	505 539	408 444
GWB-2A2 GWB-2A4	1/2" GWB both sides with panel perpendicular to framing and 1-1/2" lateral strap at mid-height--along horizontal joint (framing at 24 in. o.c.--fasteners at 4"/4"--8'x8' wall)	915 783	0.95 0.97	783 690	600 602

<sup>1</sup> crippling in compression stud above hold-down or at web cutout above hold-down

Table 6 Phase 3 test results

Test Specimen	Wall Description	Nominal load capacity (last stable hysteretic loops) <sup>1</sup> , lb/ft.	Displacement at last stable hysteretic loops <sup>1</sup> , in.
AISI-OSB1 AISI-OSB2	7/16" OSB APA rated sheathing w/panels on one side--parallel to framing (framing at 24 in. o.c.--fasteners at 6"/12"--4"x8" wall)	700 700	1.8 1.8
AISI-OSB3 AISI-OSB4	7/16" OSB APA rated sheathing w/panels on one side--parallel to framing (framing at 24 in. o.c.--fasteners at 4"/12"--4"x8" wall)	1000 825	1.8 1.2
AISI-OSB5 <sup>2</sup> AISI-OSB6 <sup>2</sup>	7/16" OSB APA rated sheathing w/panels on one side--parallel to framing (framing at 24 in. o.c.--fasteners at 3"/12"--4"x8" wall)	1450 1100	2.3 1.2
AISI-OSB7 <sup>2</sup> AISI-OSB8 <sup>2</sup>	7/16" OSB APA rated sheathing w/panels on one side--parallel to framing (framing at 24 in. o.c.--fasteners at 2"/12"--4"x8" wall)	1650 1750	1.7 1.7
AISI-PLY1 AISI-PLY2	15/32" plywood APA rated sheathing (4-ply) w/panels one side--parallel to framing (framing at 24 in. o.c.--fasteners at 6"/12"--4"x8" wall)	785 775	1.8 1.8
AISI-PLY3 AISI-PLY4	15/32" plywood APA rated sheathing (4-ply) w/panels one side--parallel to framing (framing at 24 in. o.c.--fasteners at 4"/12"--4"x8" wall)	975 1000	1.8 1.2
AISI-PLY5 <sup>2</sup> AISI-PLY6 <sup>2</sup>	15/32" plywood APA rated sheathing (4-ply) w/panels one side--parallel to framing (framing at 24 in. o.c.--fasteners at 3"/12"--4"x8" wall)	1475 1450	2.3 2.3
AISI-PLY7 <sup>2</sup> AISI-PLY8 <sup>2</sup>	15/32" plywood APA rated sheathing (4-ply) w/panels one side--parallel to framing (framing at 24 in. o.c.--fasteners at 2"/12"--4"x8" wall)	1675 1575	2.7 1.7

<sup>1</sup> based on the lowest strength curve (average of the +/- values)

<sup>2</sup> crippling in compression stud above hold-down or at web cutout above hold-down

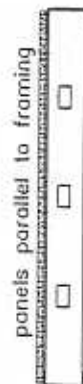
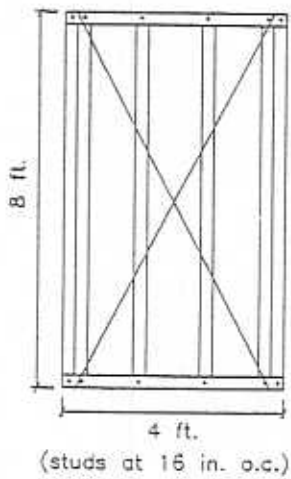
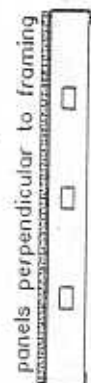
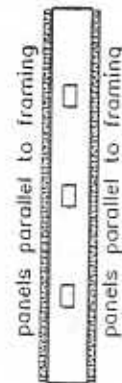
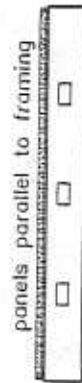
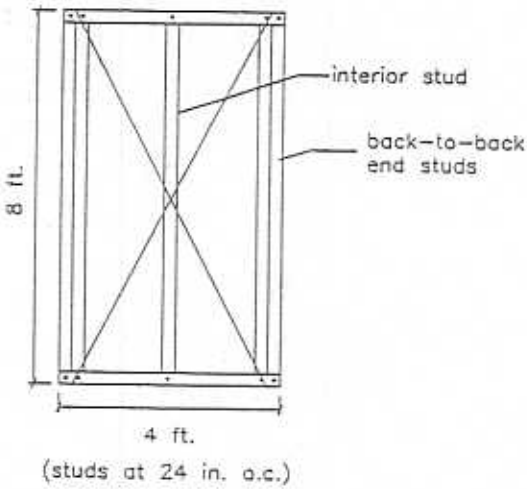
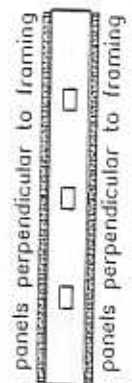
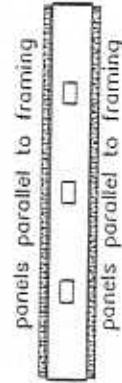
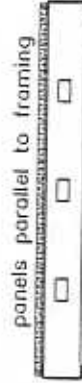
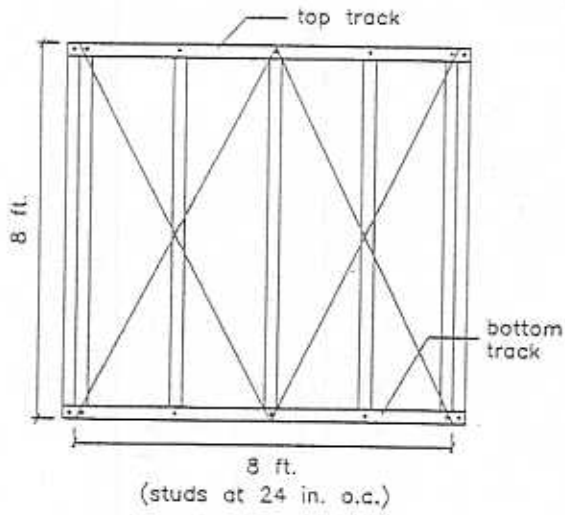
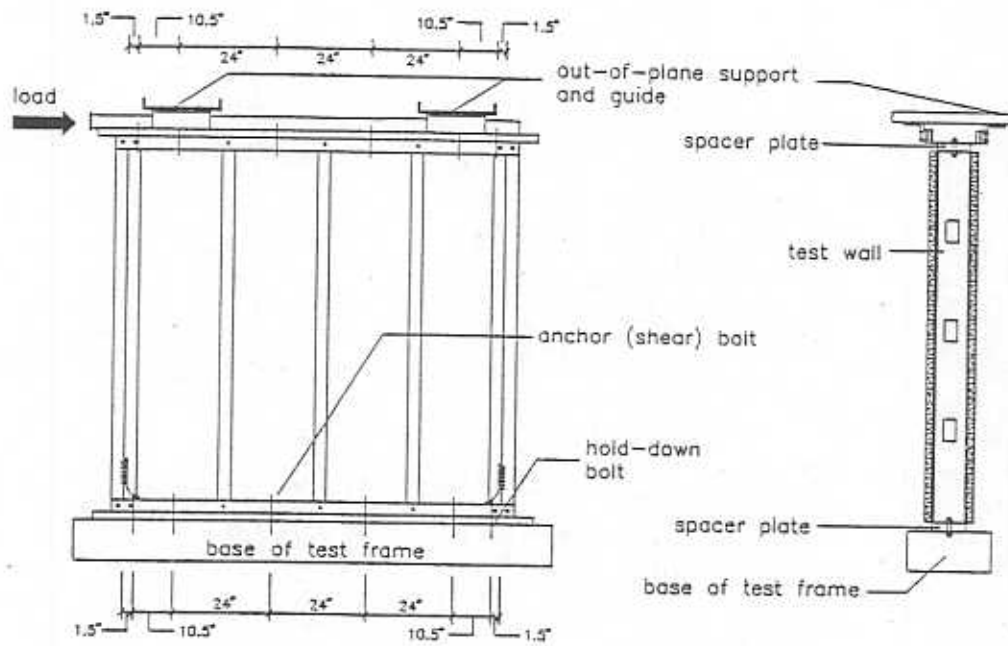
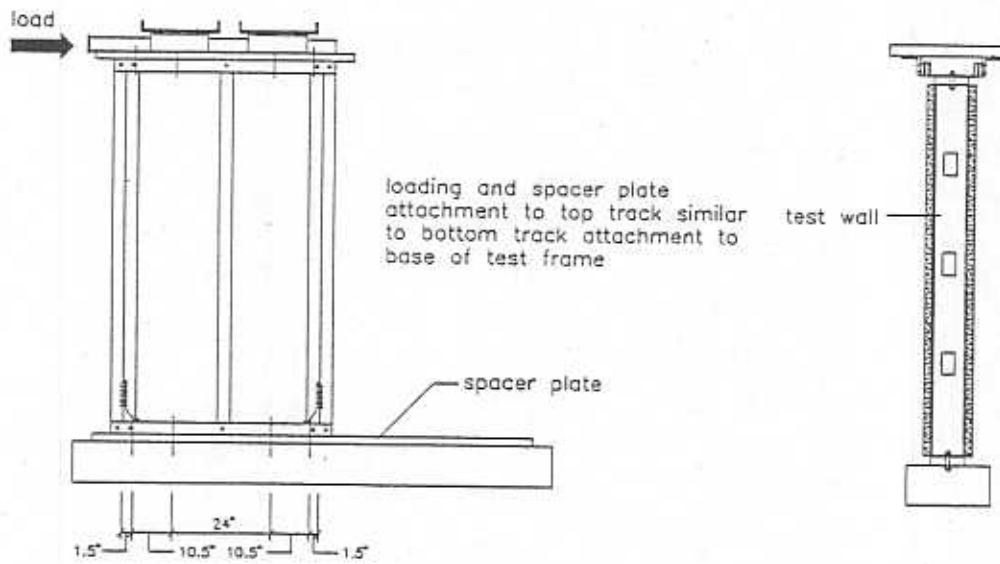

Figure 1 8 ft. x 8 ft. and 4 ft. x 8 ft. walls



8 ft. x 8 ft. static test--SCU



4 ft. x 8 ft. static test--SCU

Figure 2 Overall test setup

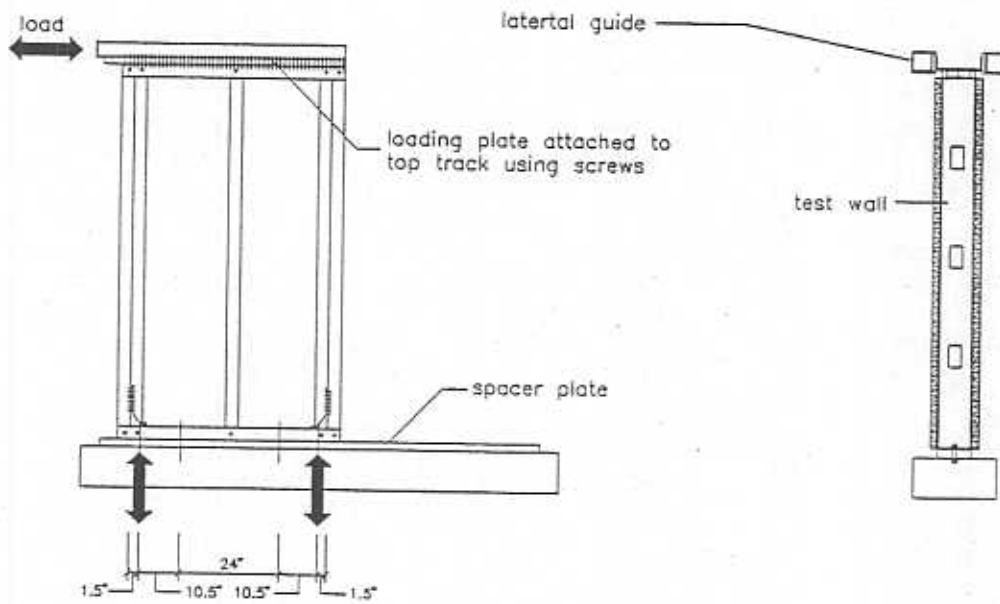

4 ft. x 8 ft. cyclic test--Simpson

Figure 2 Overall test setup (continued)



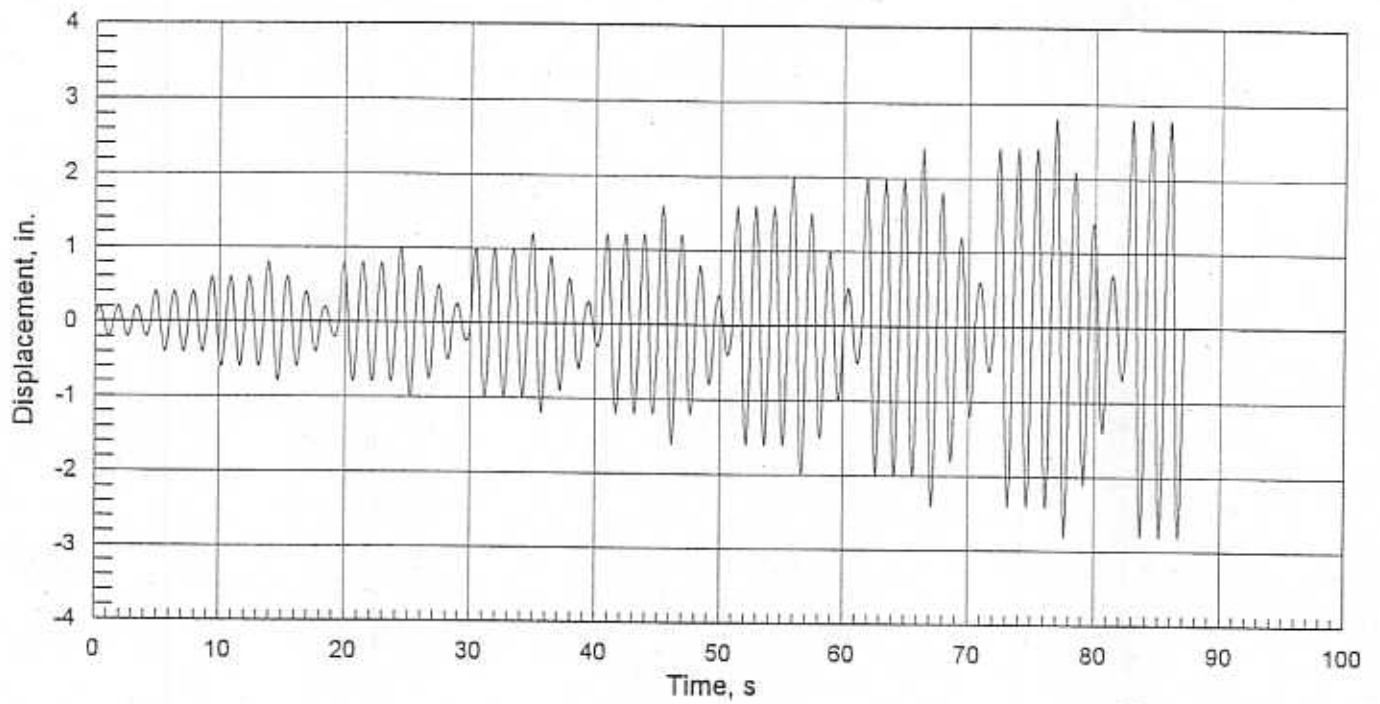

Displacement, in.	No. of Cycles
0.2	3
0.4	3
0.6	3
0.8	1
0.6	1
0.4	1
0.2	1
0.8	3
1	1
0.7	1
0.5	1
0.2	1
1	3
1.2	1
0.9	1
0.6	1
0.3	1
1.2	3
1.6	1
1.2	1
0.8	1

Displacement, in.	No. of Cycles
0.4	1
1.6	3
2	1
1.5	1
1	1
0.5	1
2	3
2.4	1
1.8	1
1.2	1
0.6	1
2.4	3
2.8	1
2.1	1
1.4	1
0.7	1
2.8	3

Figure 3 Cyclic test protocol

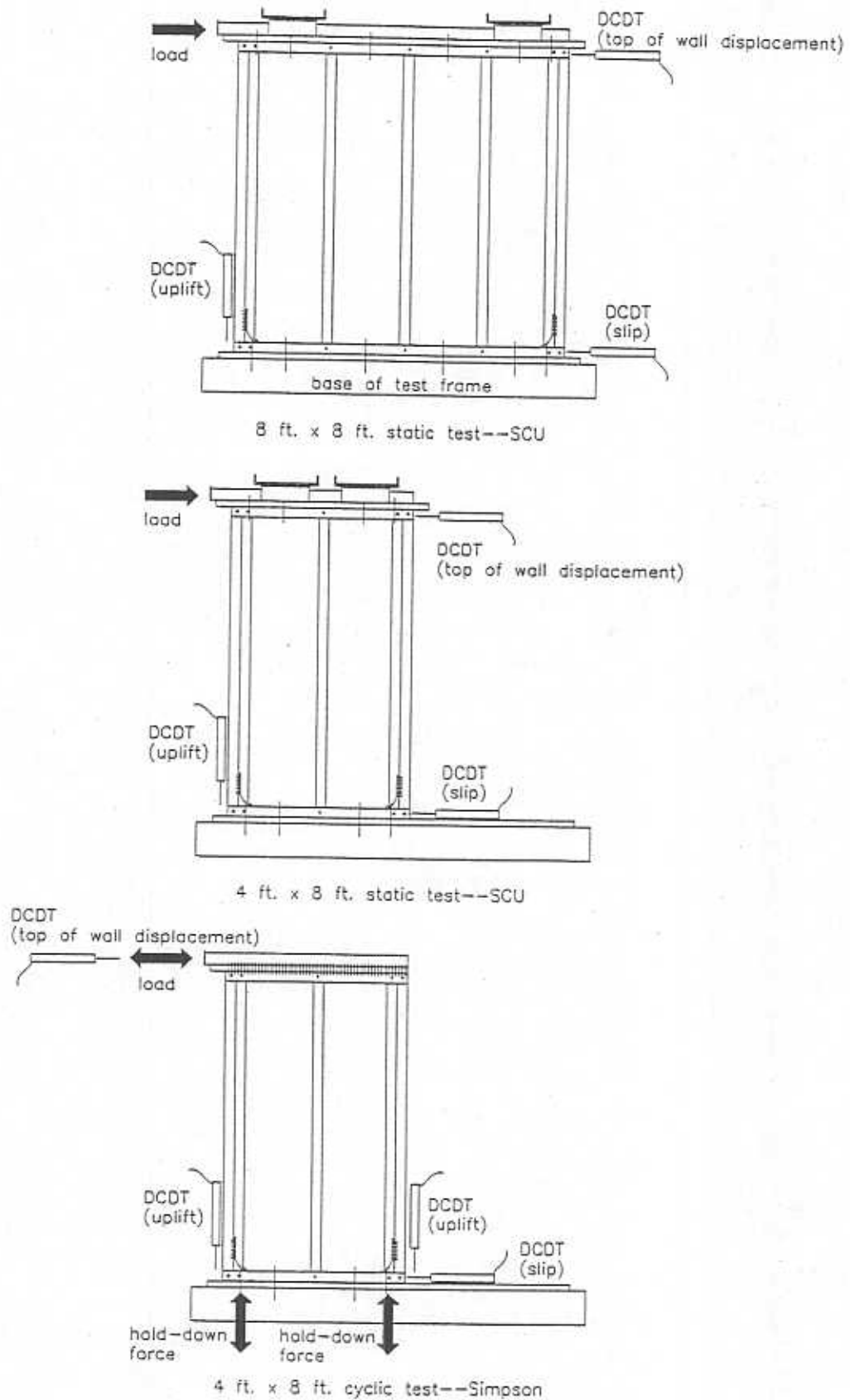

Figure 4 Instrumentation for static and cyclic tests

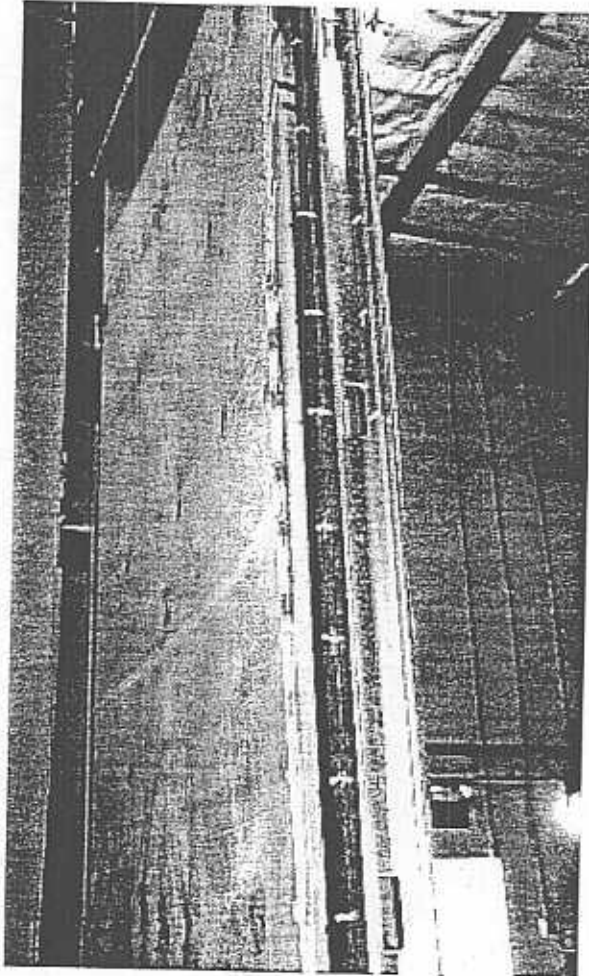

Figure 5 Basic mode of failure--plywood and OSB walls

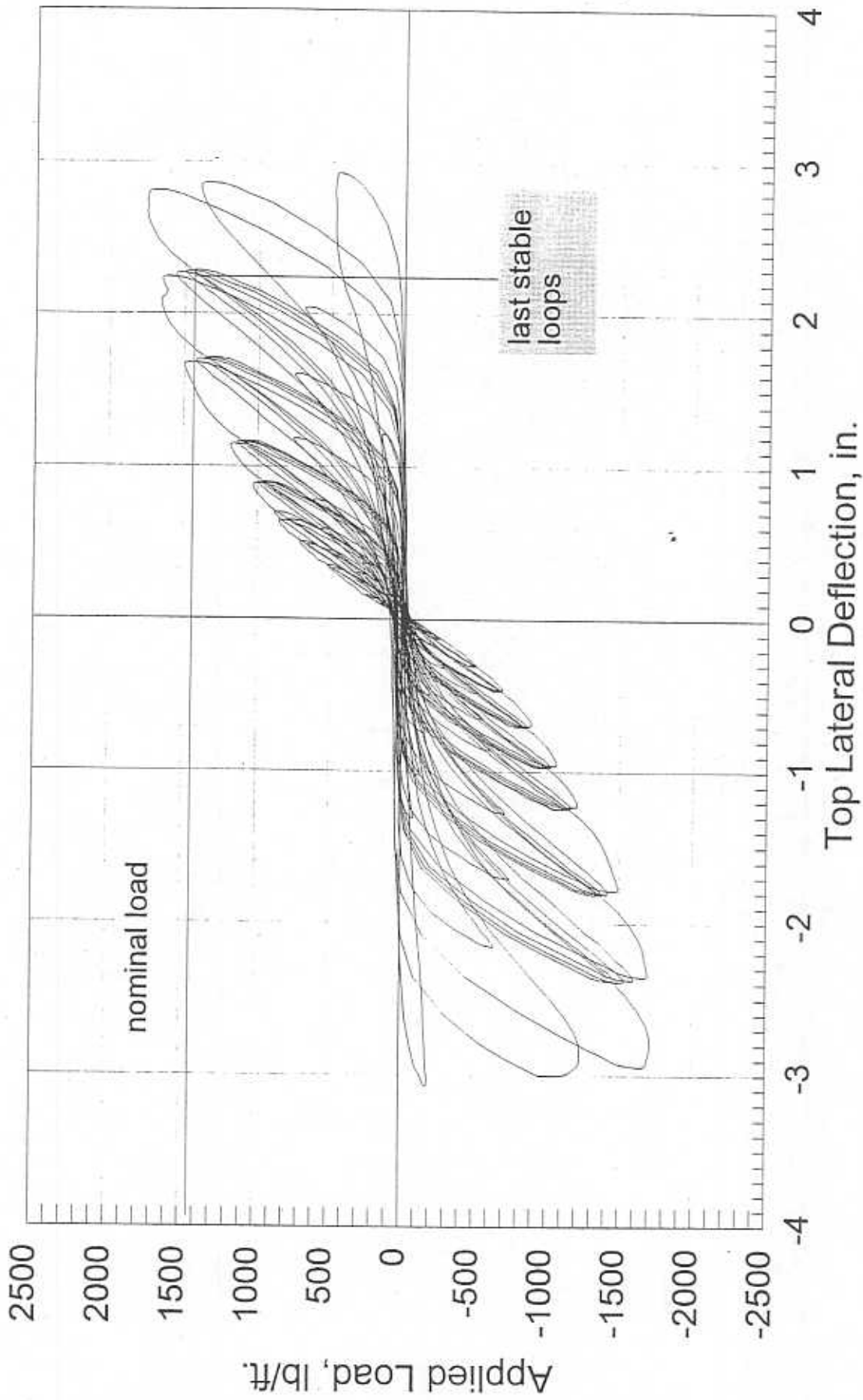

Figure 6 Typical hysteretic loops for cyclically tested wall

# Appendix A1

Phase 1 Test Results

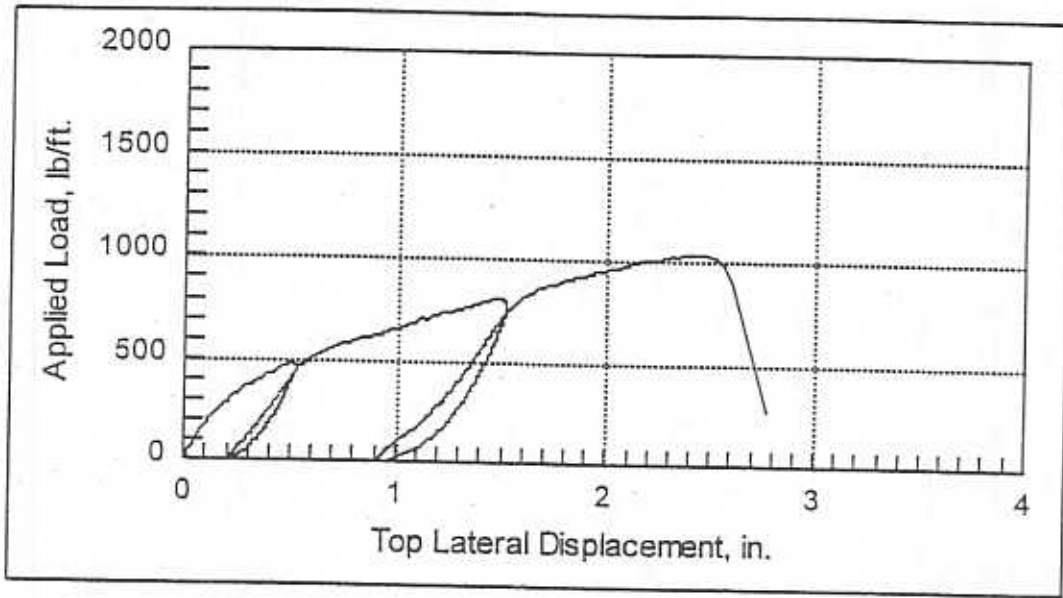

Fig. 1 Load vs. top of wall lateral displacement for specimen PLY-1A6

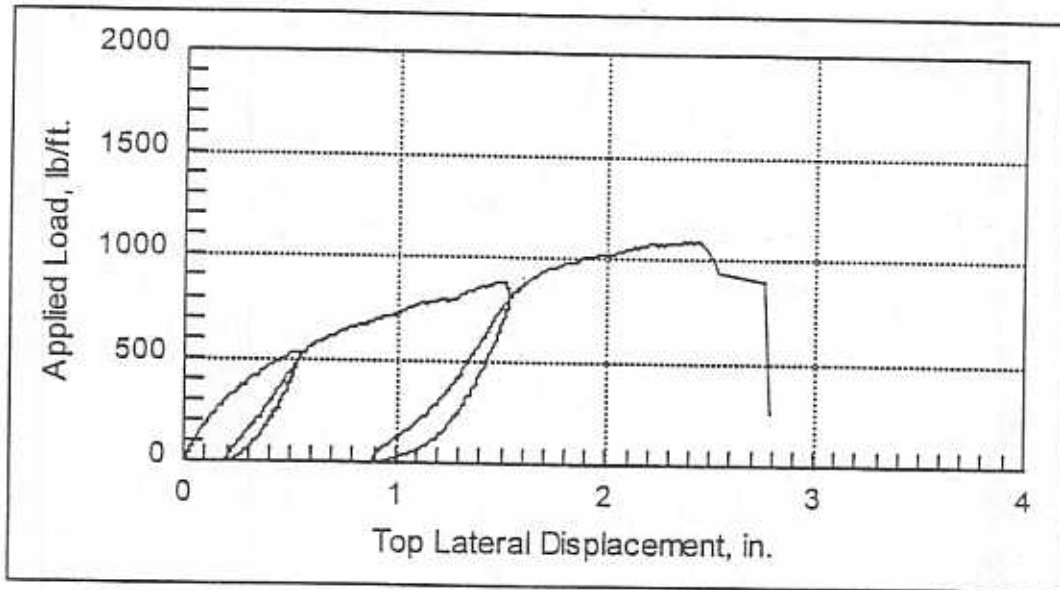

Fig. 2 Load vs. top of wall lateral displacement for specimen PLY-1A7

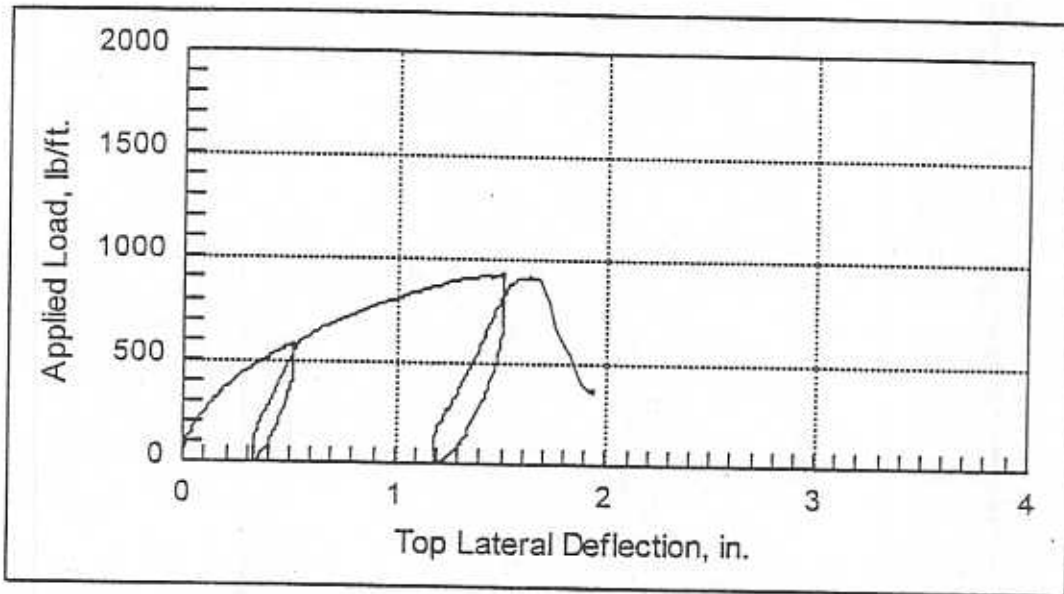

Fig. 3 Load vs. top of wall lateral displacement for specimen OSB-1A2

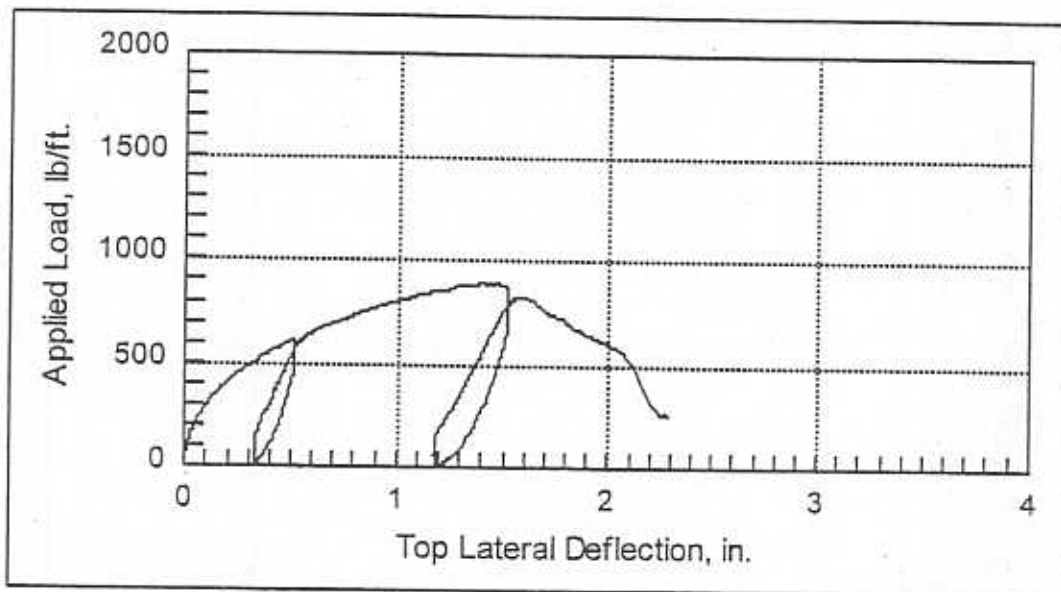

Fig. 4 Load vs. top of wall lateral displacement for specimen OSB-1A3

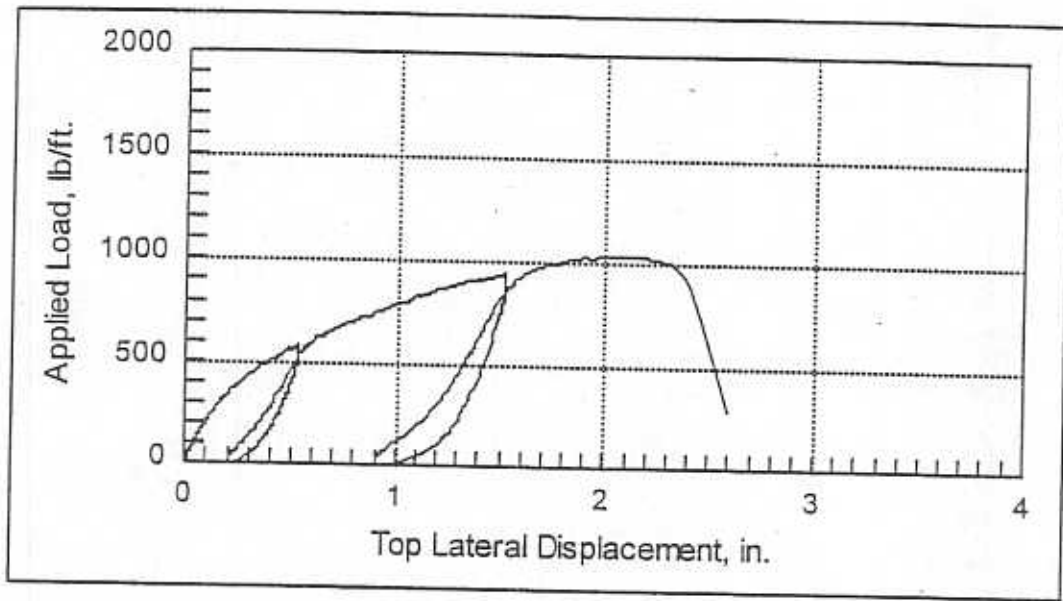

Fig. 5 Load vs. top of wall lateral displacement for specimen OSB-1A5

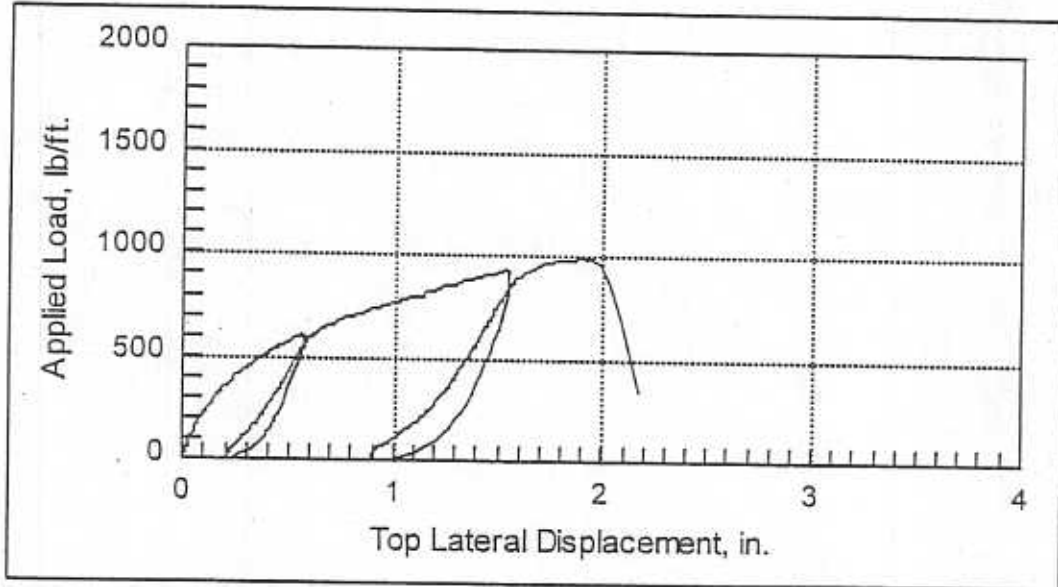

Fig. 6 Load vs. top of wall lateral displacement for specimen OSB-1A6



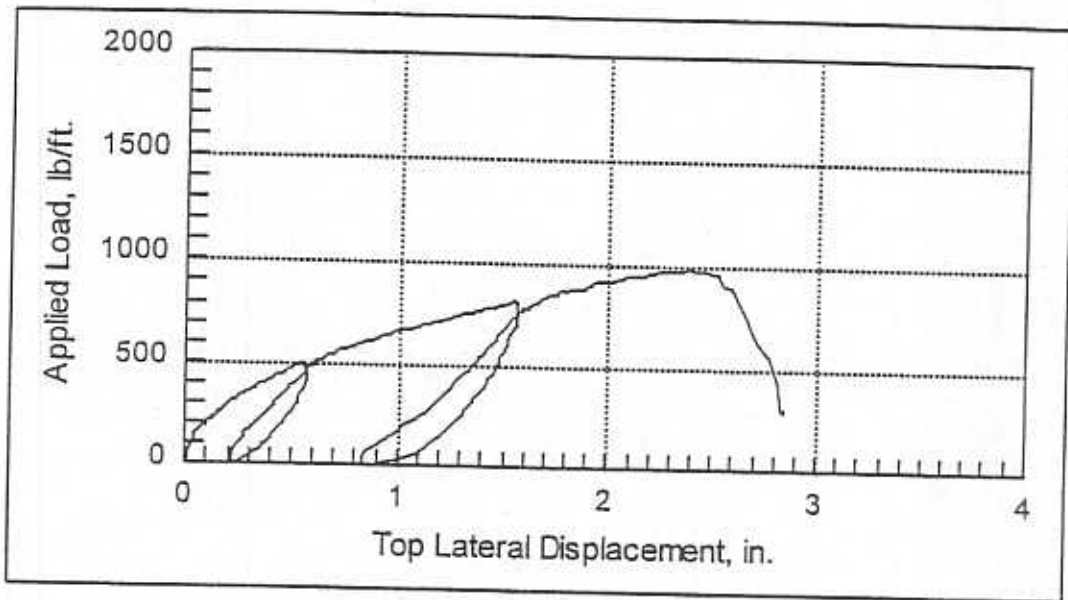

Fig. 7 Load vs. top of wall lateral displacement for specimen OSB-1E1

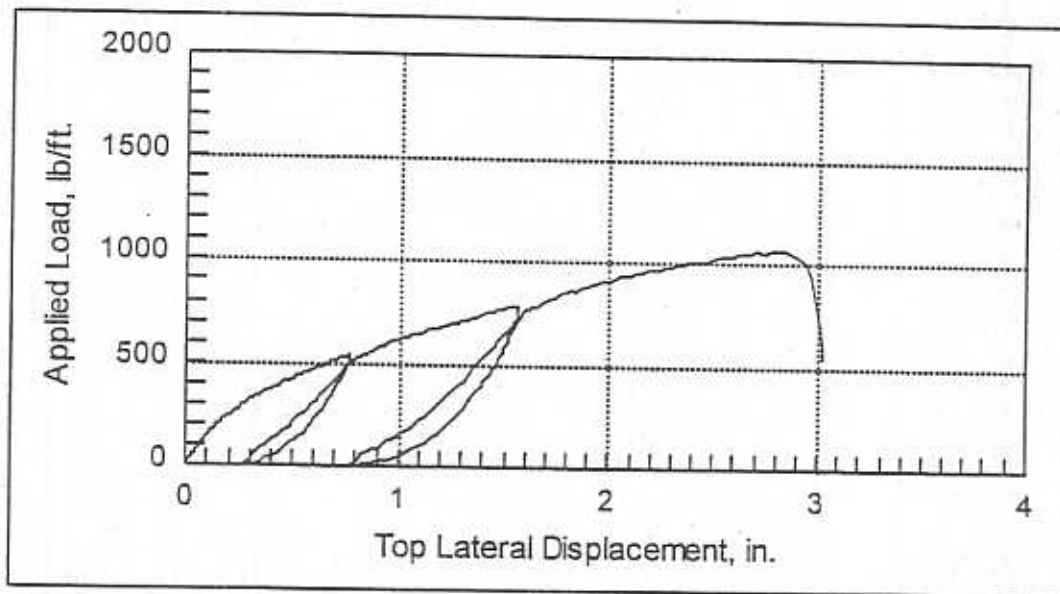

Fig. 8 Load vs. top of wall lateral displacement for specimen OSB-1E2

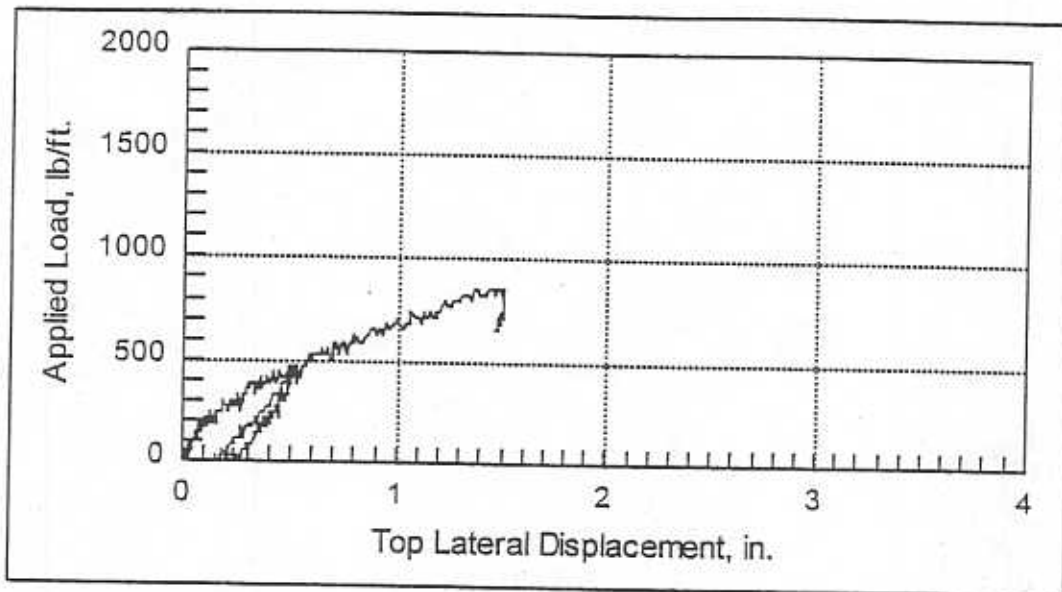

Fig. 8 Load vs. top of wall lateral displacement for specimen OSB-1D1

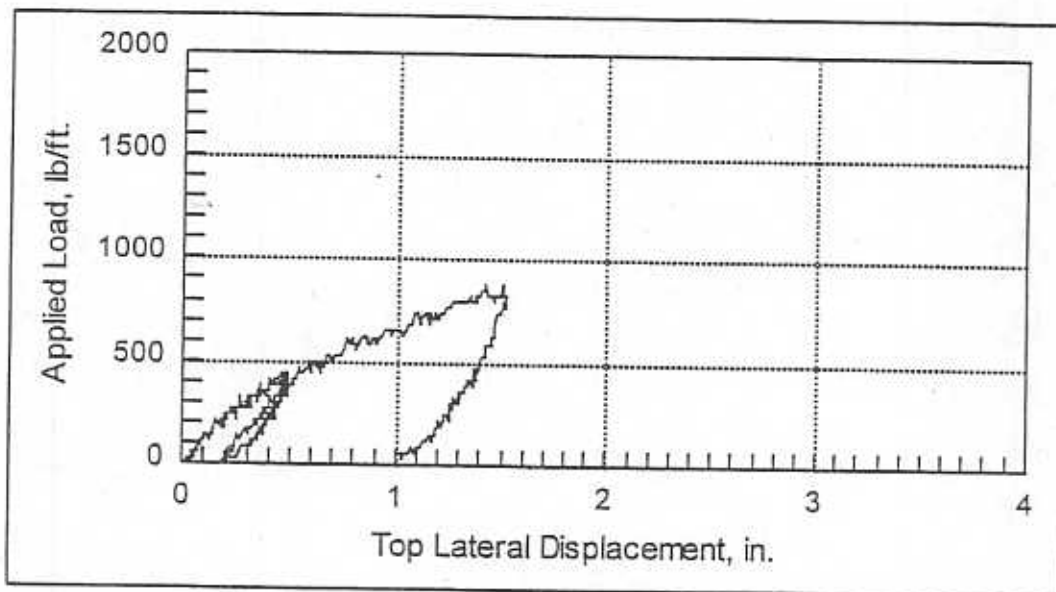

Fig. 10 Load vs. top of wall lateral displacement for specimen OSB-1D2

Appendix A2  
Phase 2 Test Results

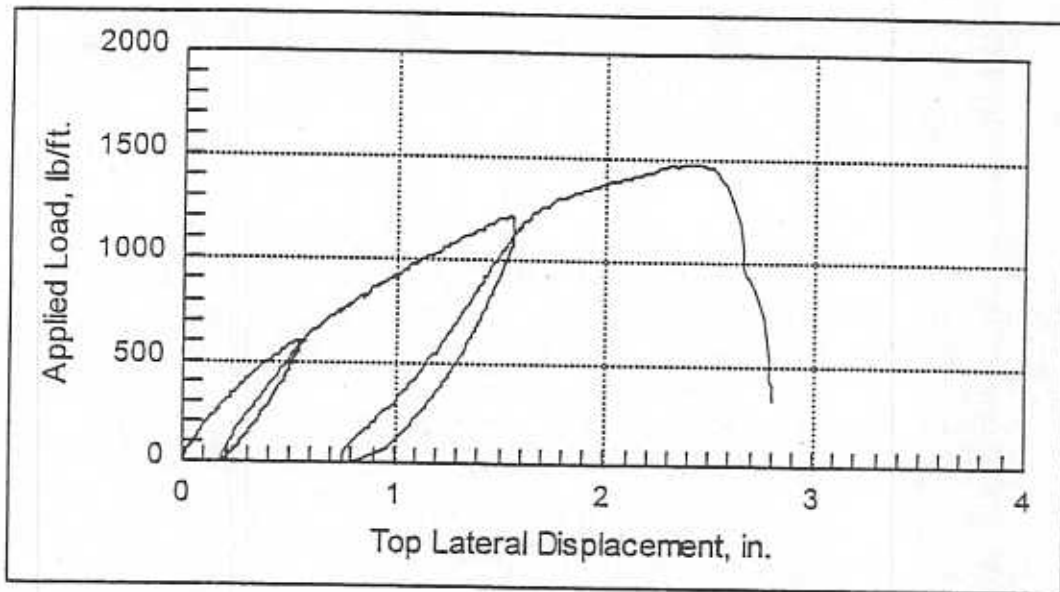

Fig. 11 Load vs. top of wall lateral displacement for specimen OSB-1D3

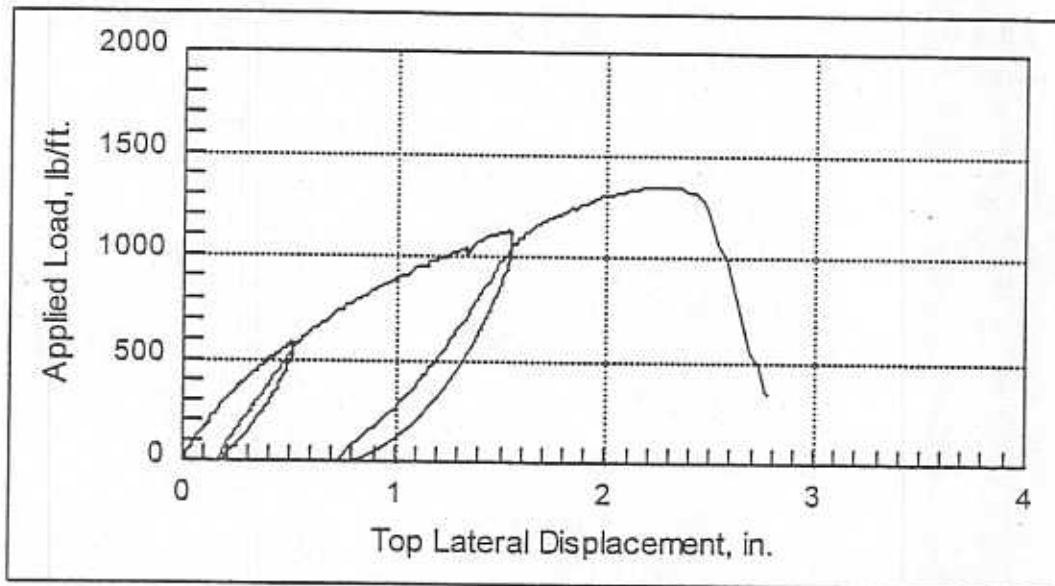

Fig. 12 Load vs. top of wall lateral displacement for specimen OSB-1D4

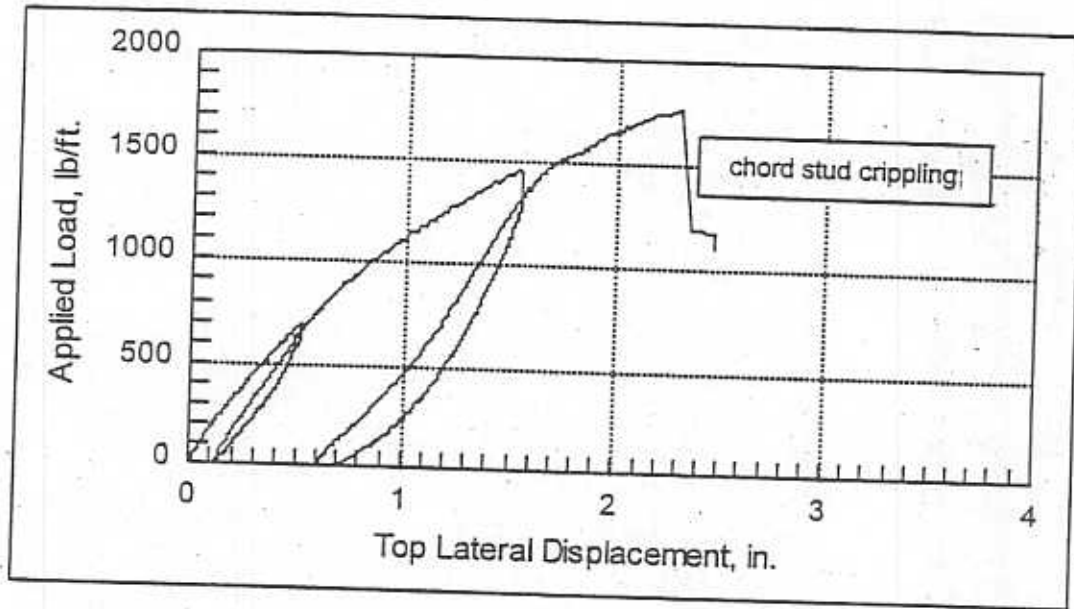

Fig. 13 Load vs. top of wall lateral displacement for specimen OSB-1D5

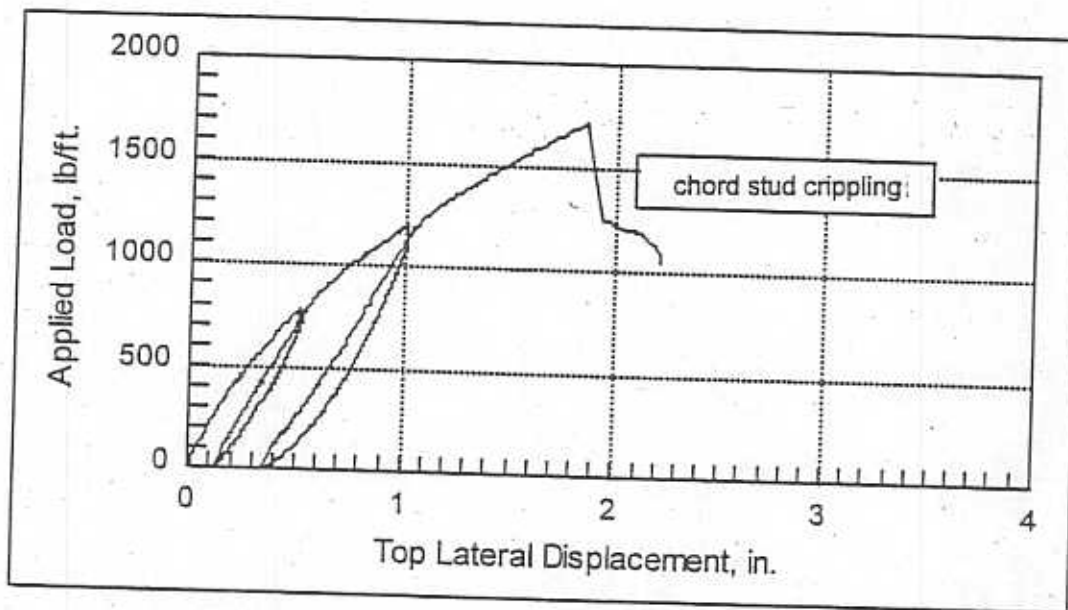

Fig. 14 Load vs. top of wall lateral displacement for specimen OSB-1D6

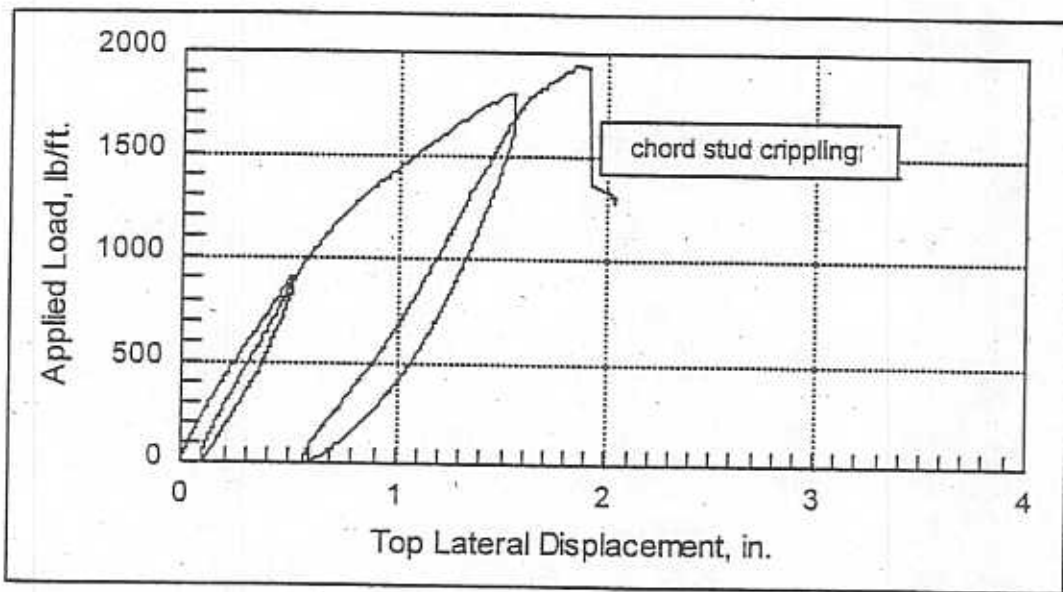

Fig. 15 Load vs. top of wall lateral displacement for specimen OSB-1D7

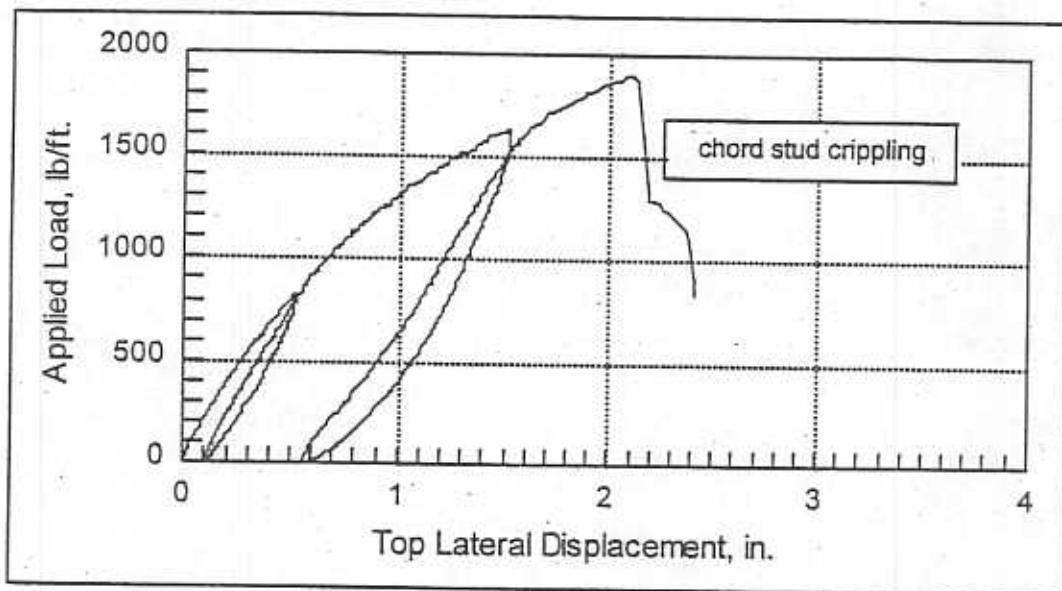

Fig. 16 Load vs. top of wall lateral displacement for specimen OSB-1D8

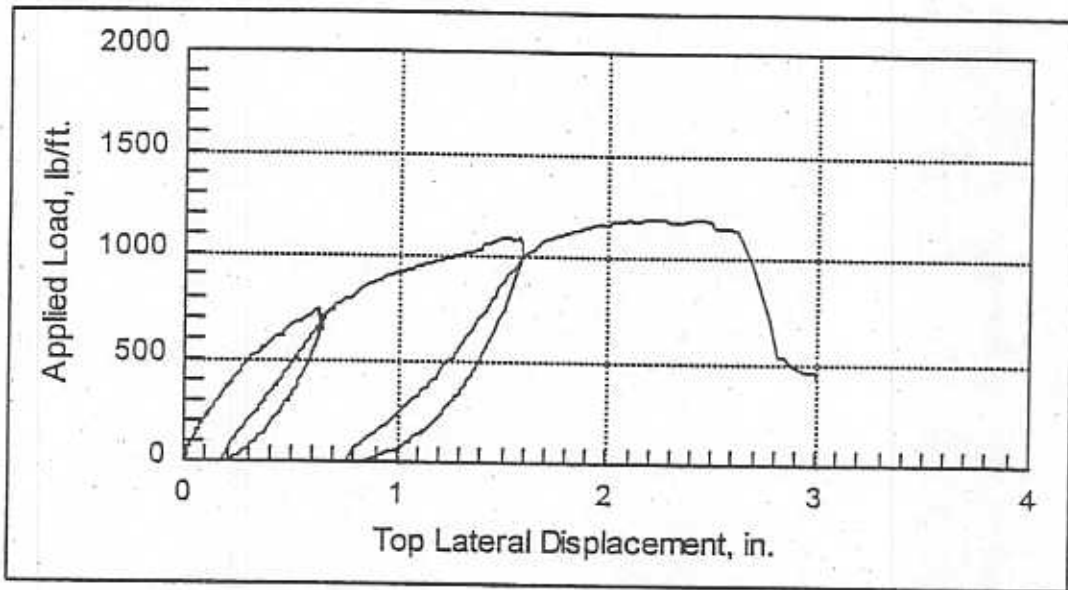

Fig. 17 Load vs. top of wall lateral displacement for specimen OSB-1F1

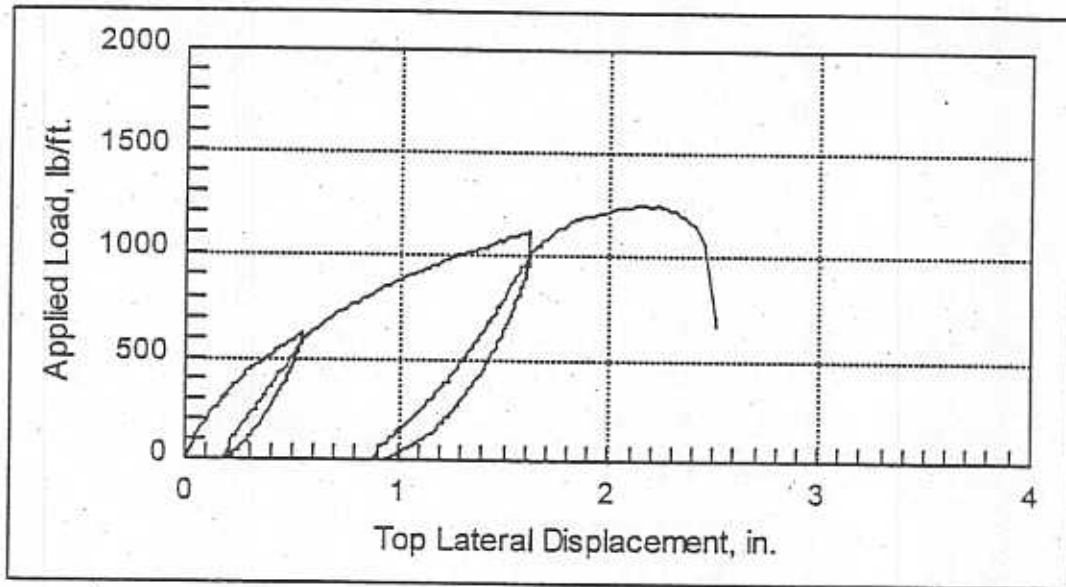

Fig. 18 Load vs. top of wall lateral displacement for specimen OSB-1F2

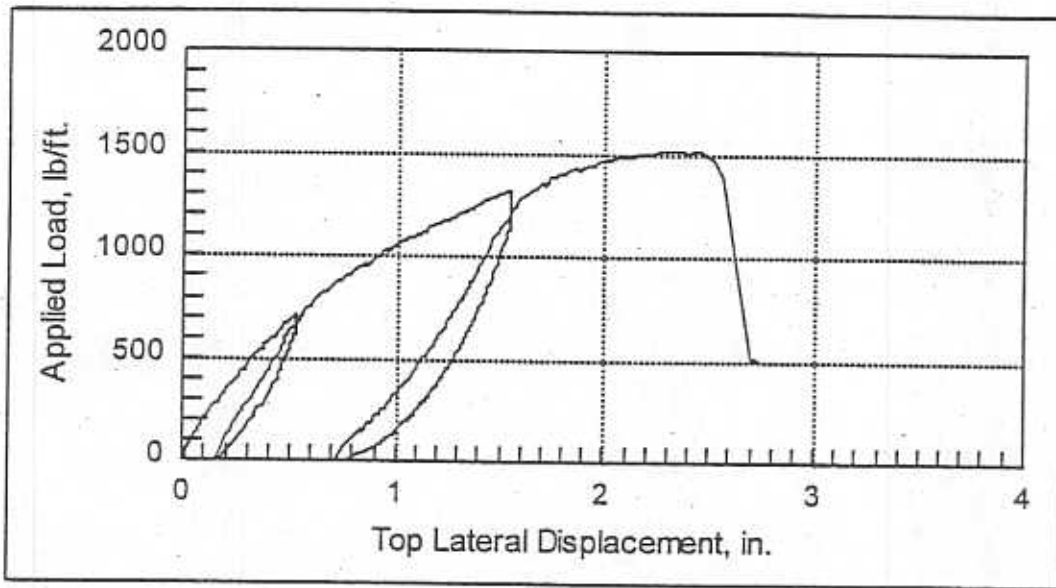

Fig. 19 Load vs. top of wall lateral displacement for specimen OSB-1F3

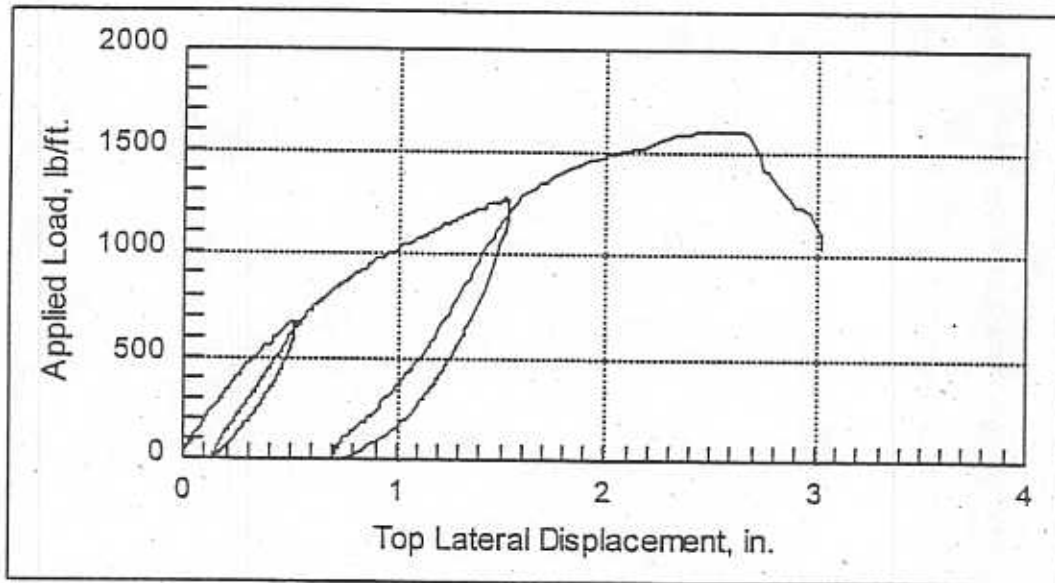

Fig. 20 Load vs. top of wall lateral displacement for specimen OSB-1F4



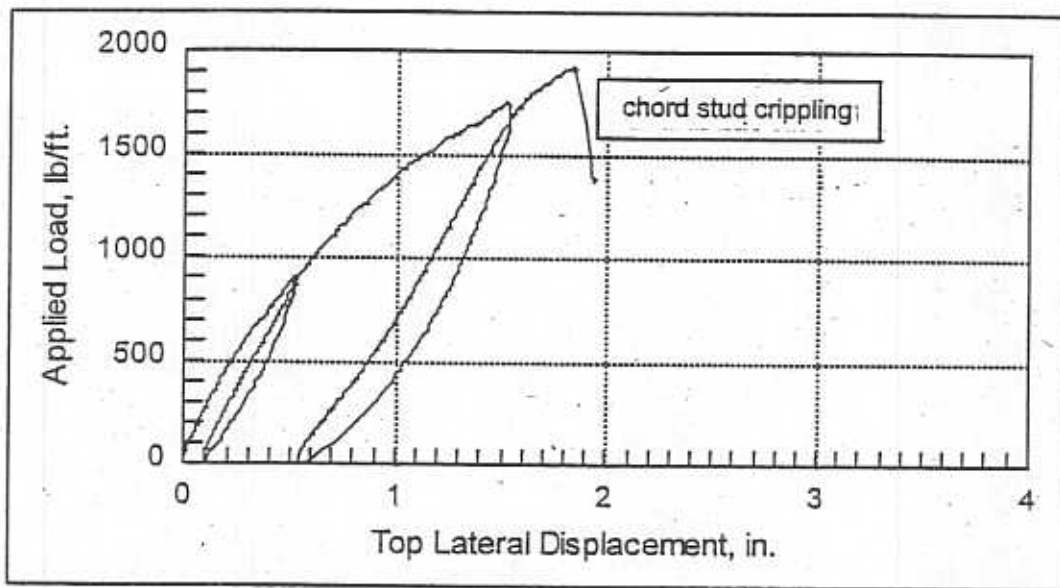

Fig. 21 Load vs. top of wall lateral displacement for specimen OSB-1F5

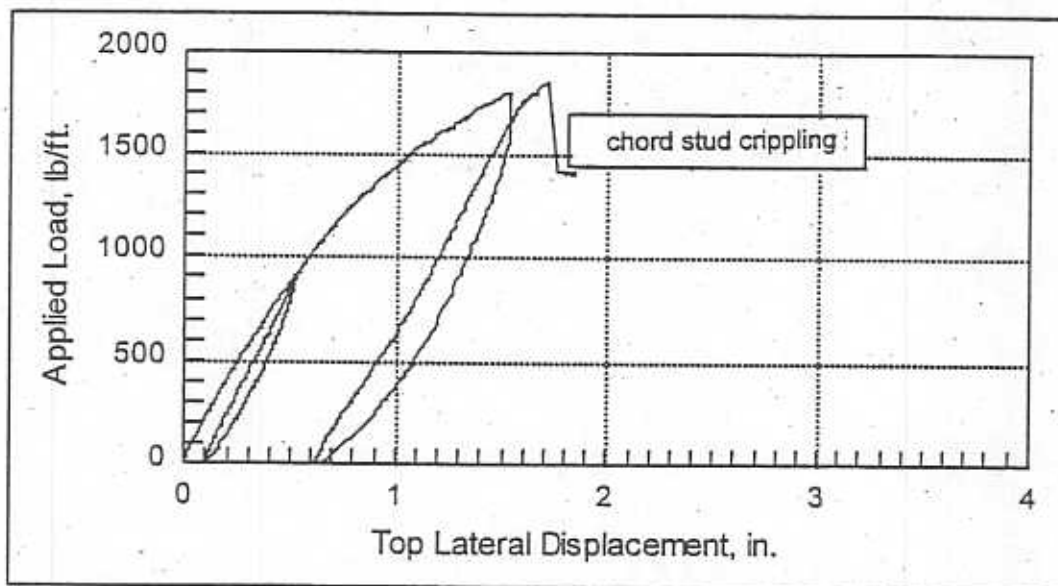

Fig. 22 Load vs. top of wall lateral displacement for specimen OSB-1F6

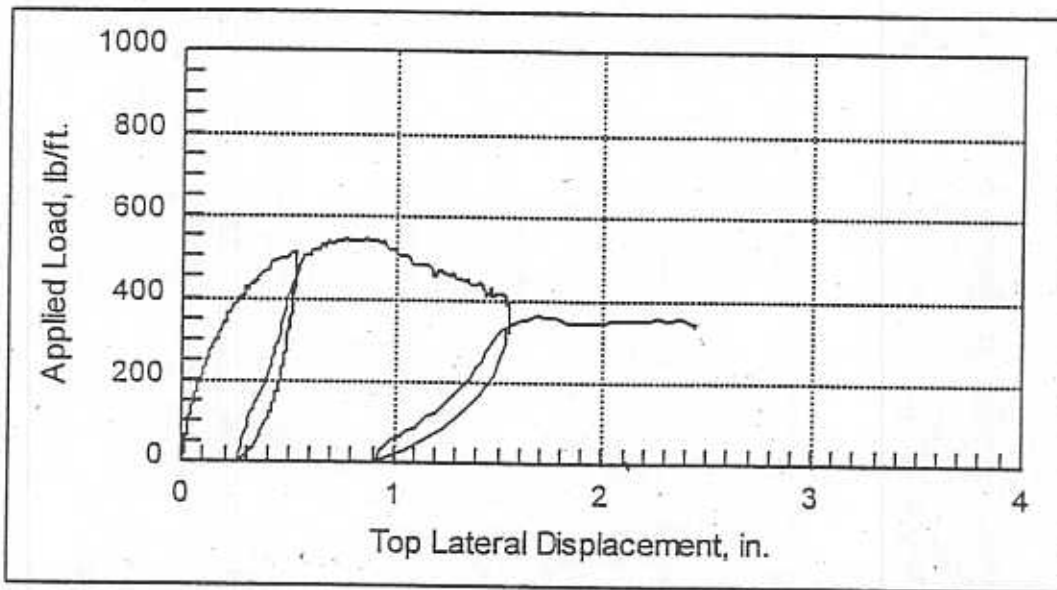

Fig. 23 Load vs. top of wall lateral displacement for specimen GWB-2A1

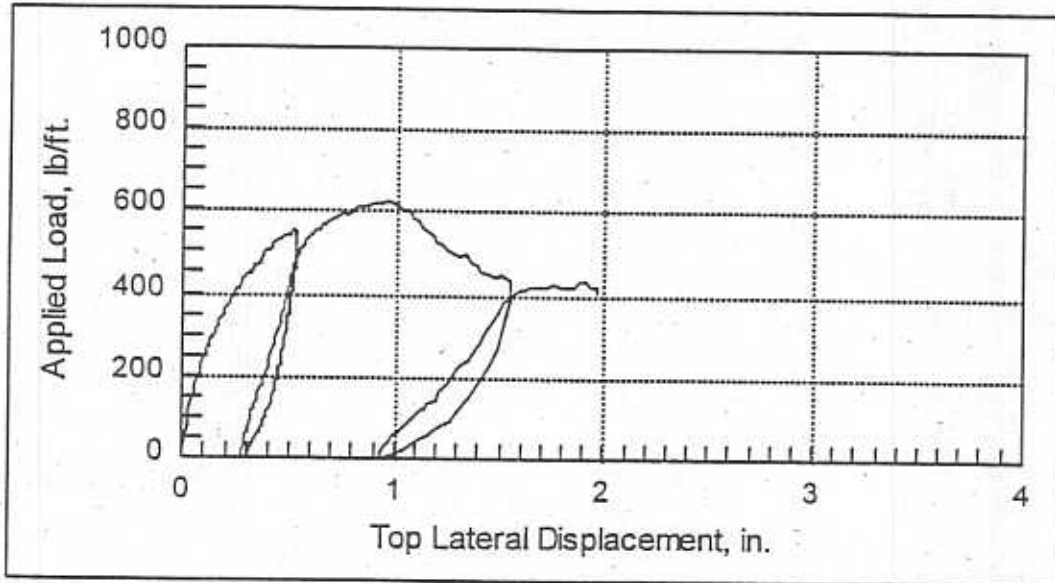

Fig. 24 Load vs. top of wall lateral displacement for specimen GWB-2A3

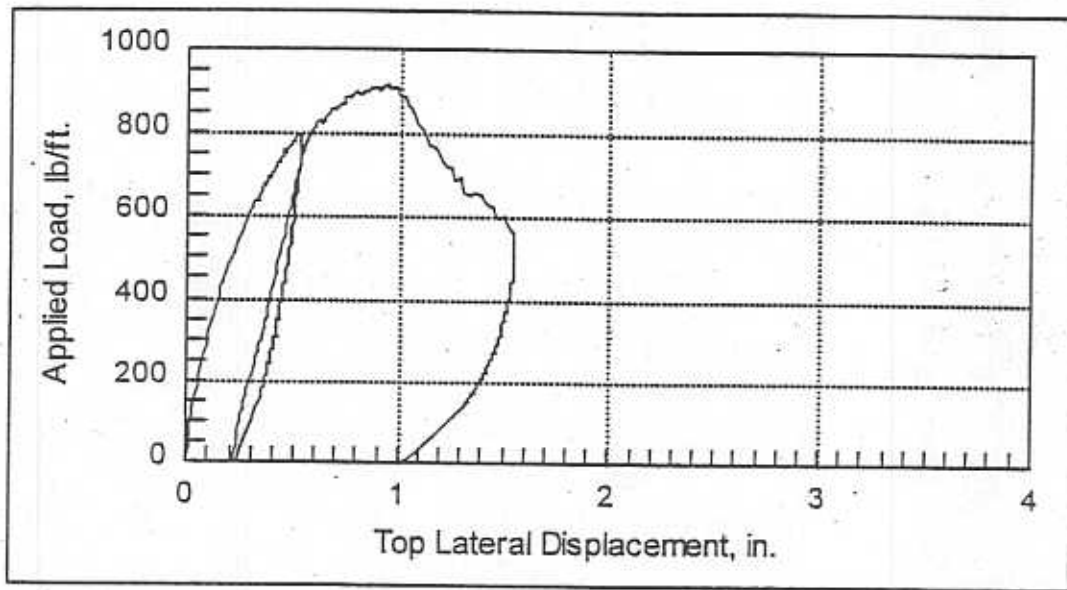

Fig. 25 Load vs. top of wall lateral displacement for specimen GWB-2A2

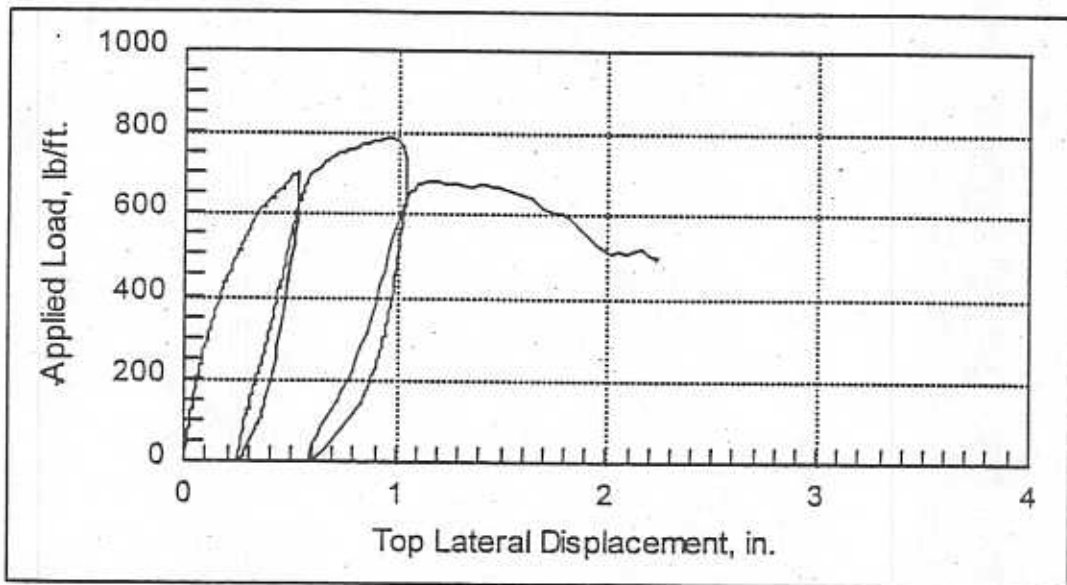

Fig. 26 Load vs. top of wall lateral displacement for specimen GWB-2A4

## Appendix A3

### Phase 3 Test Results

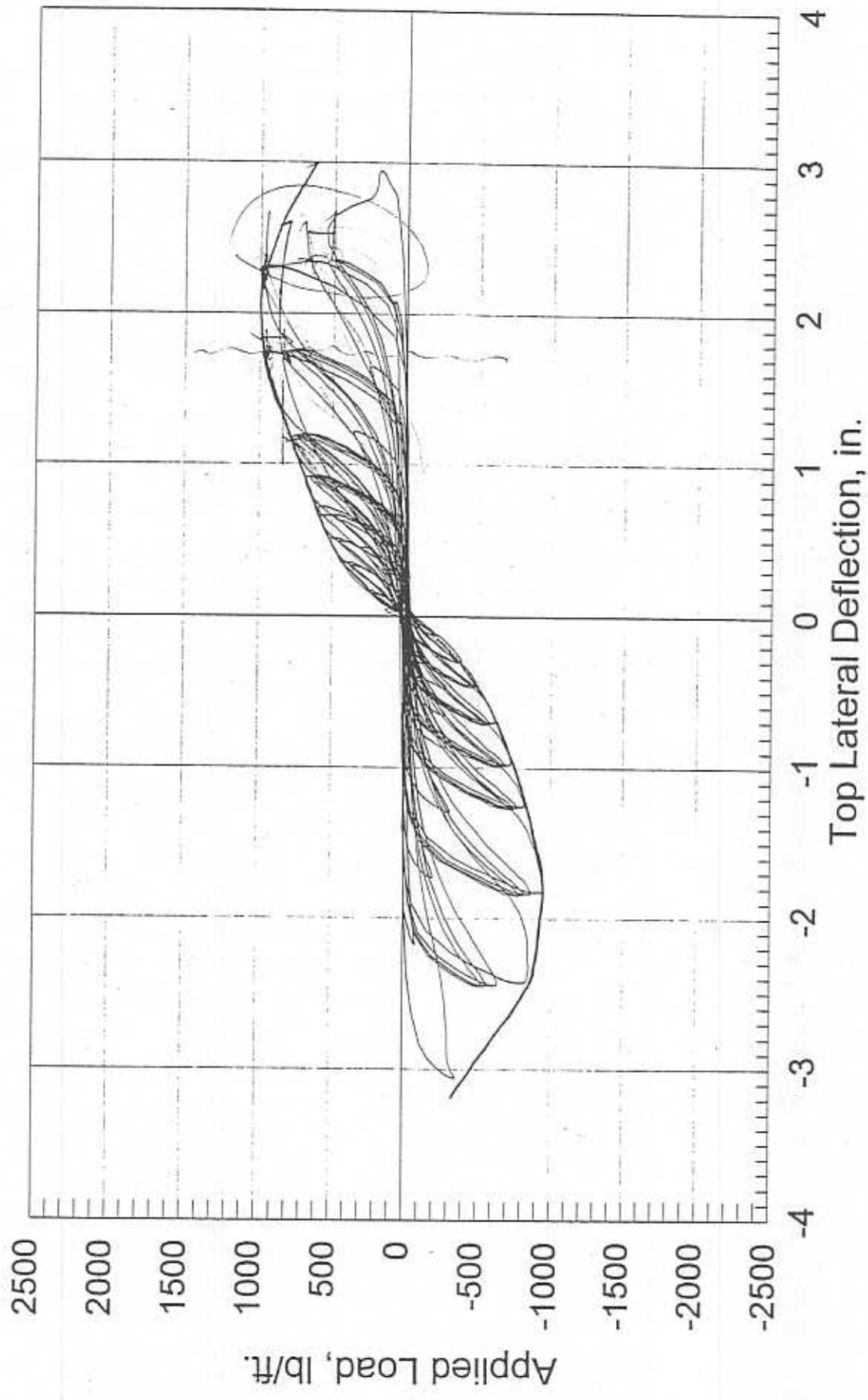

Fig. 28 Load vs. top of wall lateral displacement for specimen AISI-OSB2

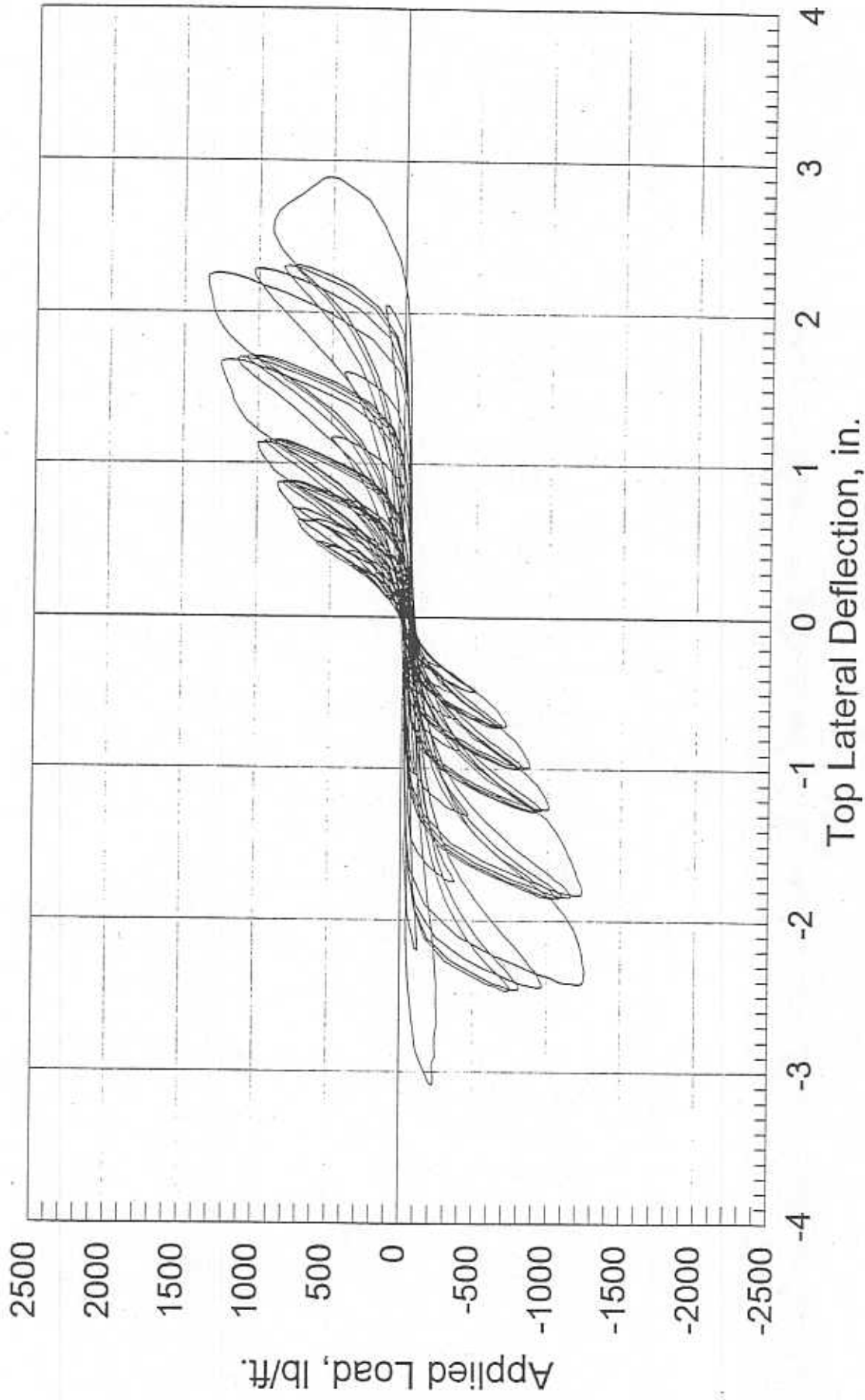

Fig. 29 Load vs. top of wall lateral displacement for specimen AISI-OSB3

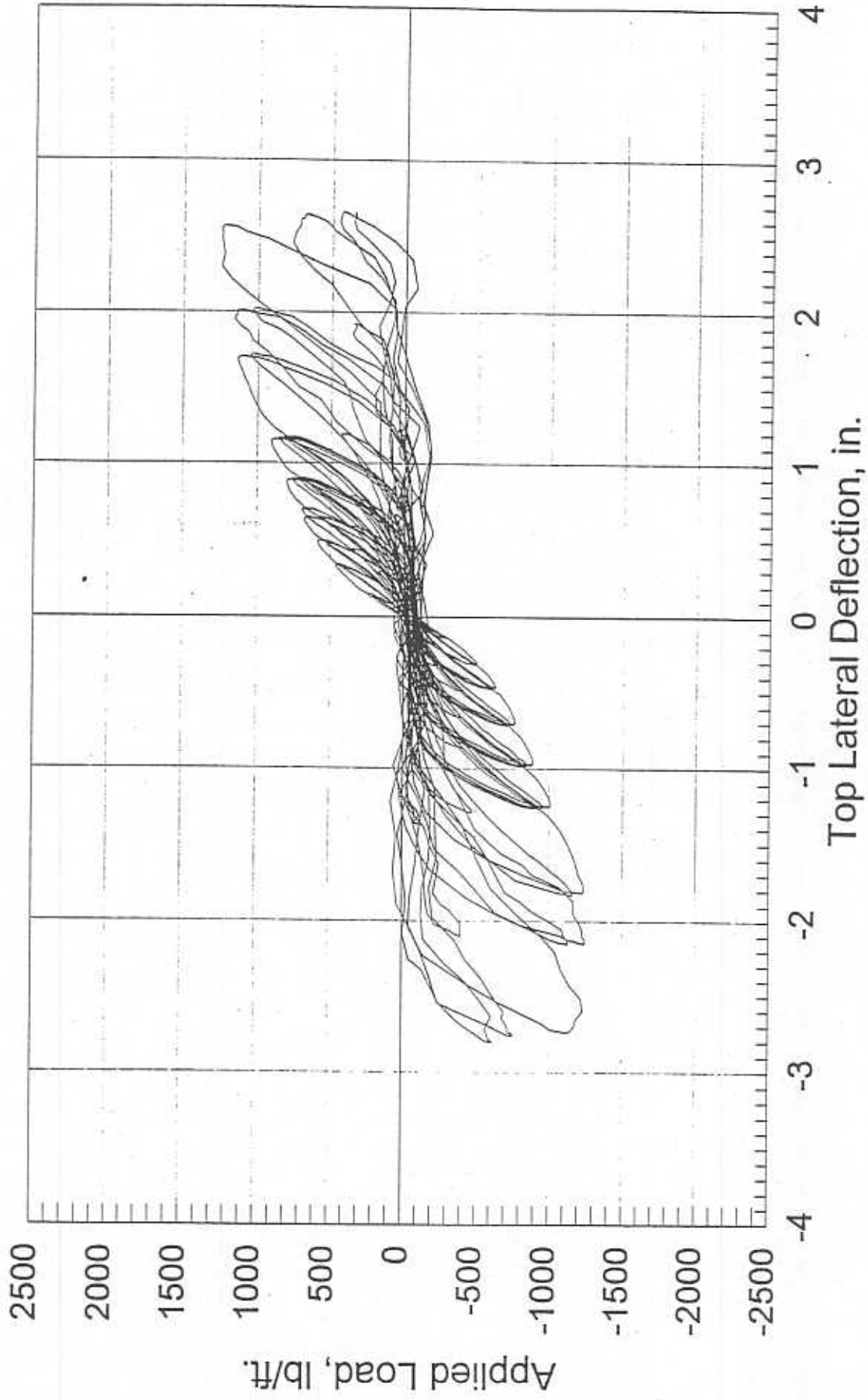

Fig. 30 Load vs. top of wall lateral displacement for specimen AISI-OSB4

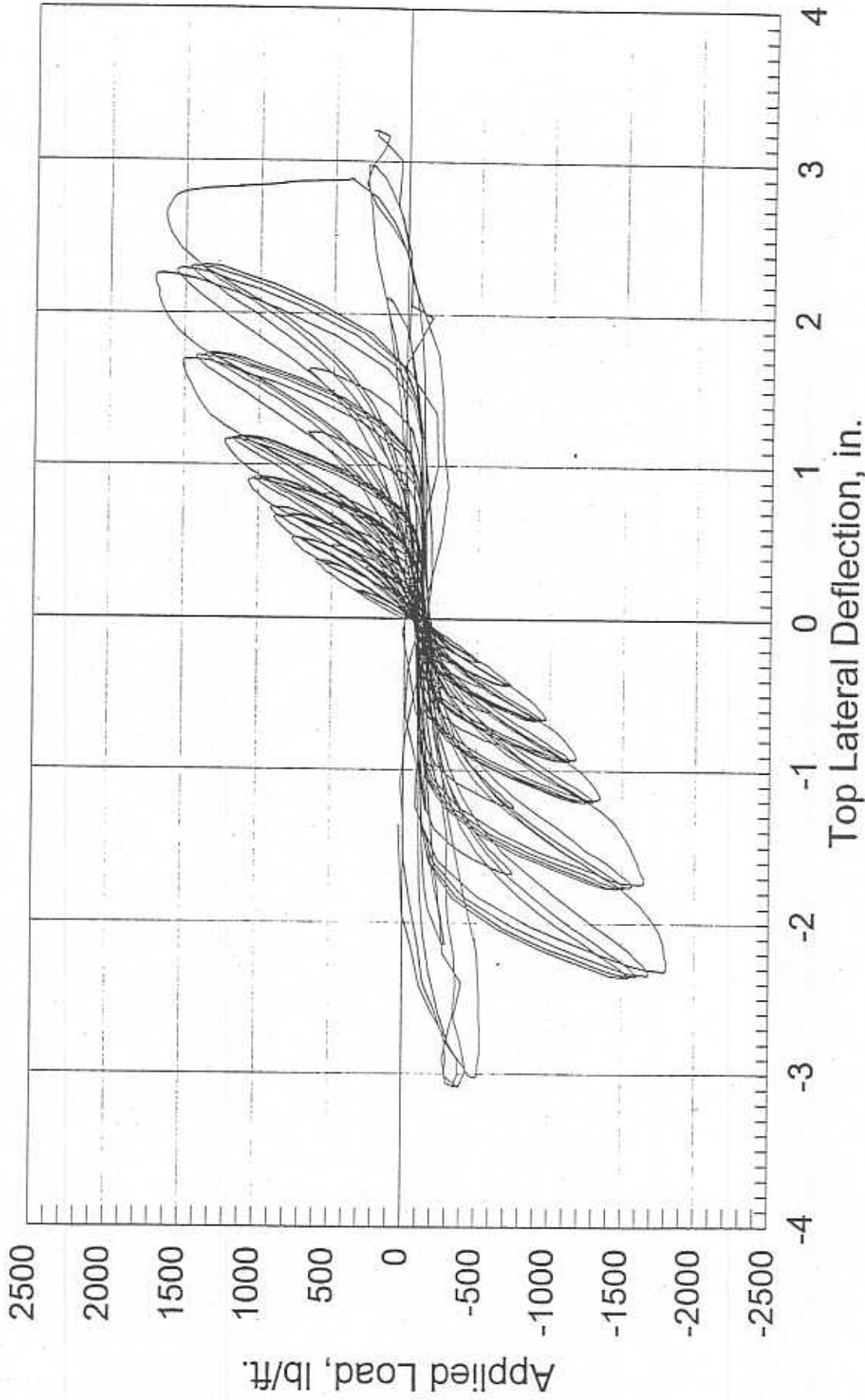

Fig. 31 Load vs. top of wall lateral displacement for specimen AISI-OSB5



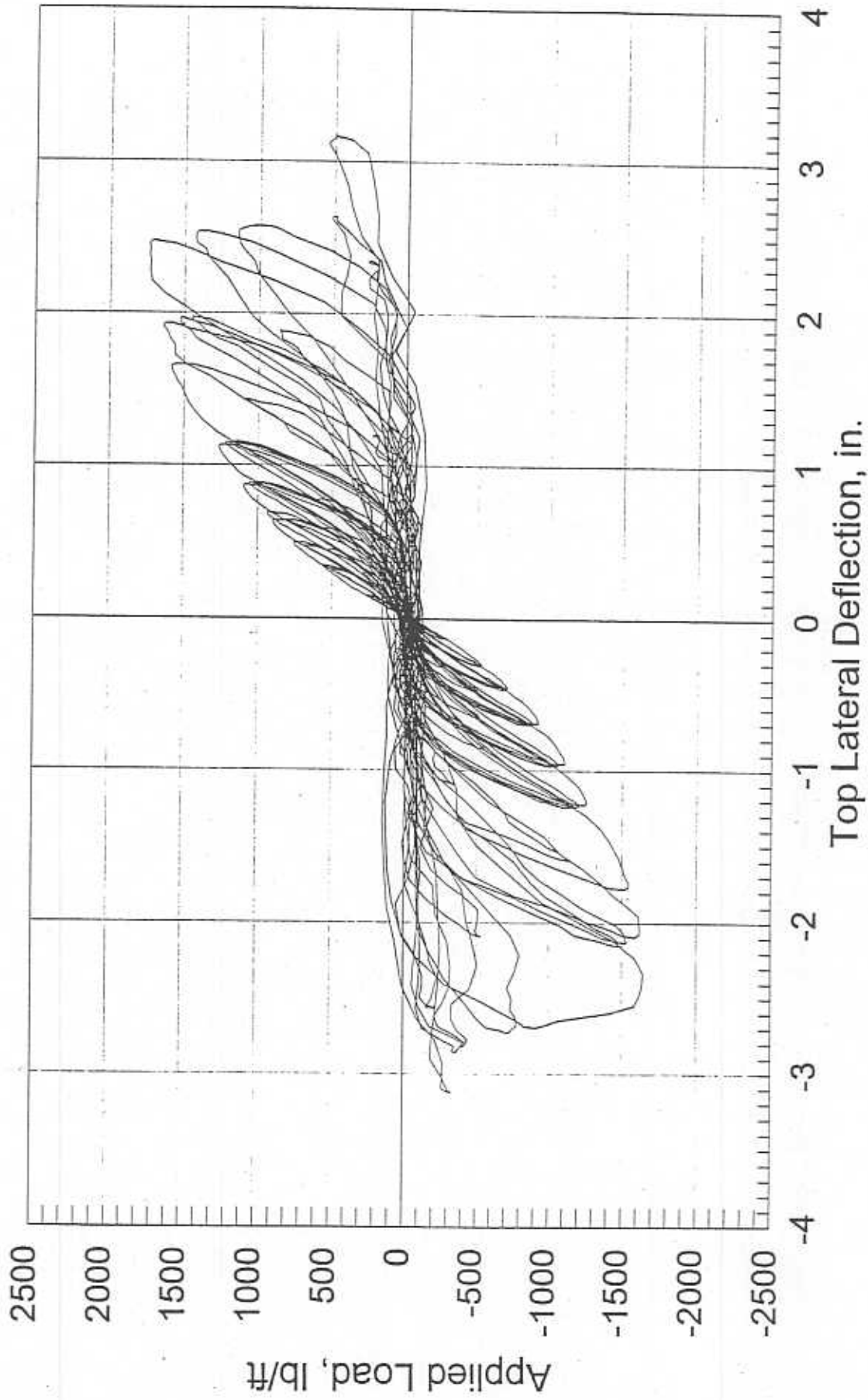

Fig. 32 Load vs. top of wall lateral displacement for specimen AISI-OSB6

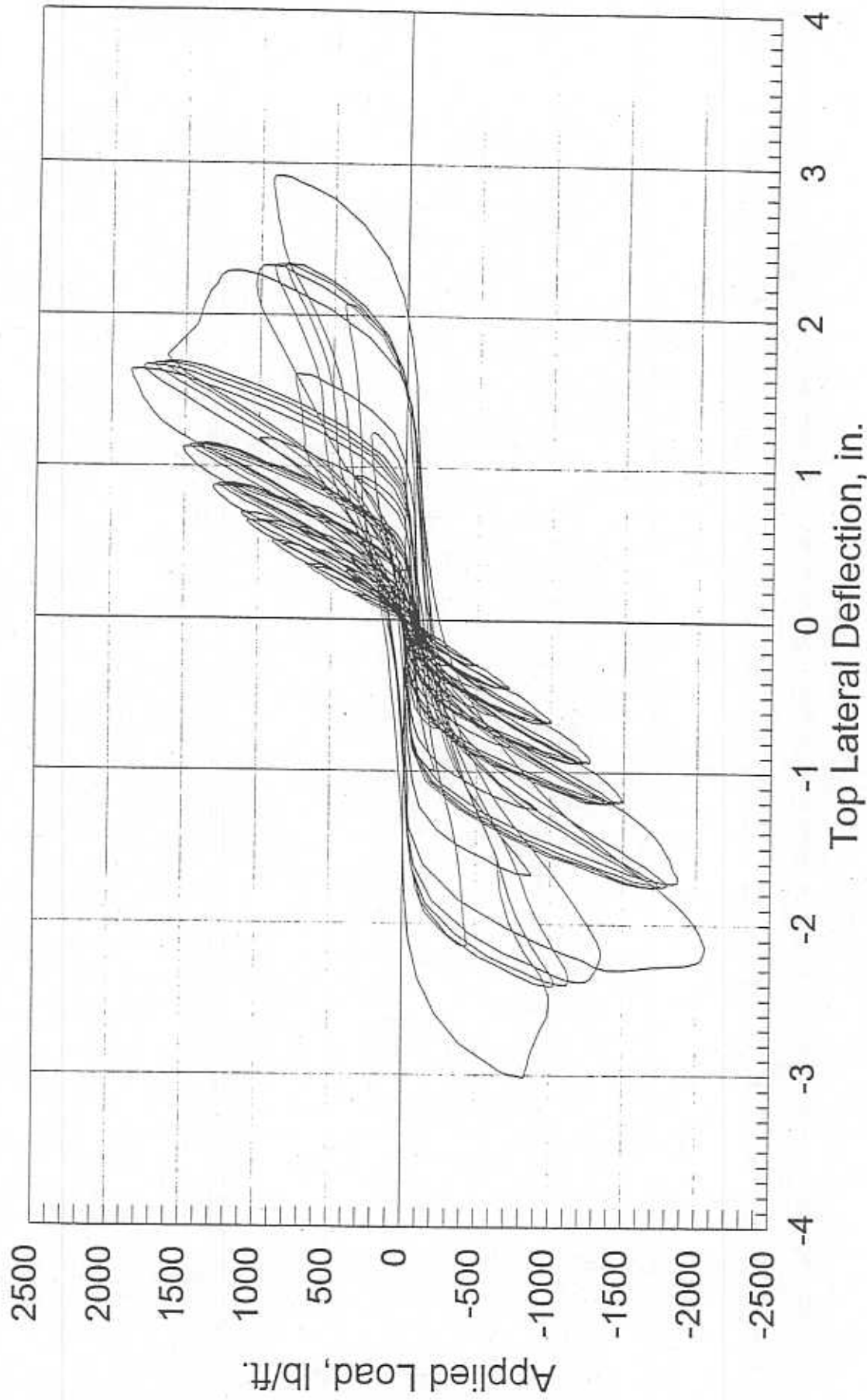

Fig. 33 Load vs. top of wall lateral displacement for specimen AISI-OSB7

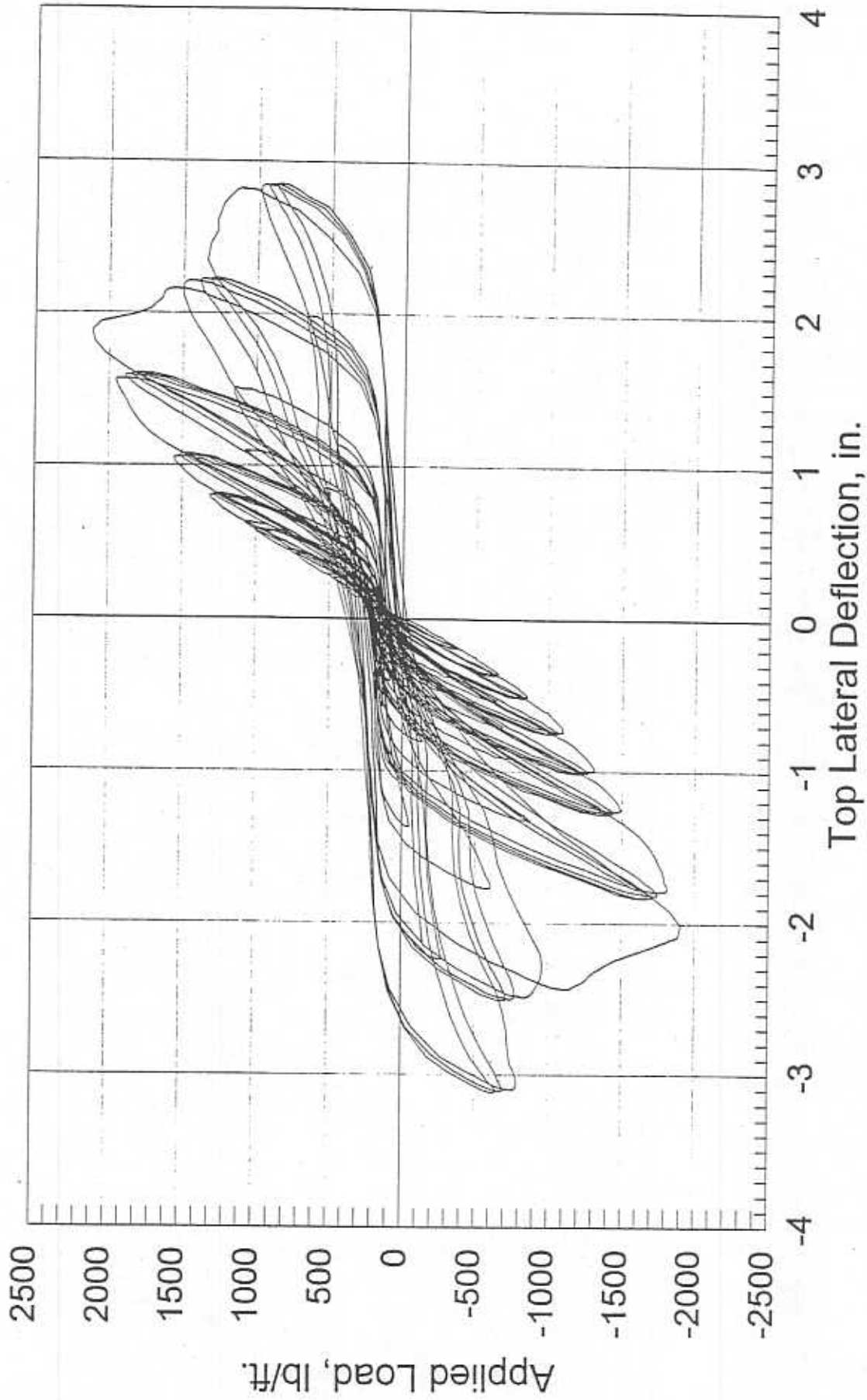

Fig. 34 Load vs. top of wall lateral displacement for specimen AISI-OSB8

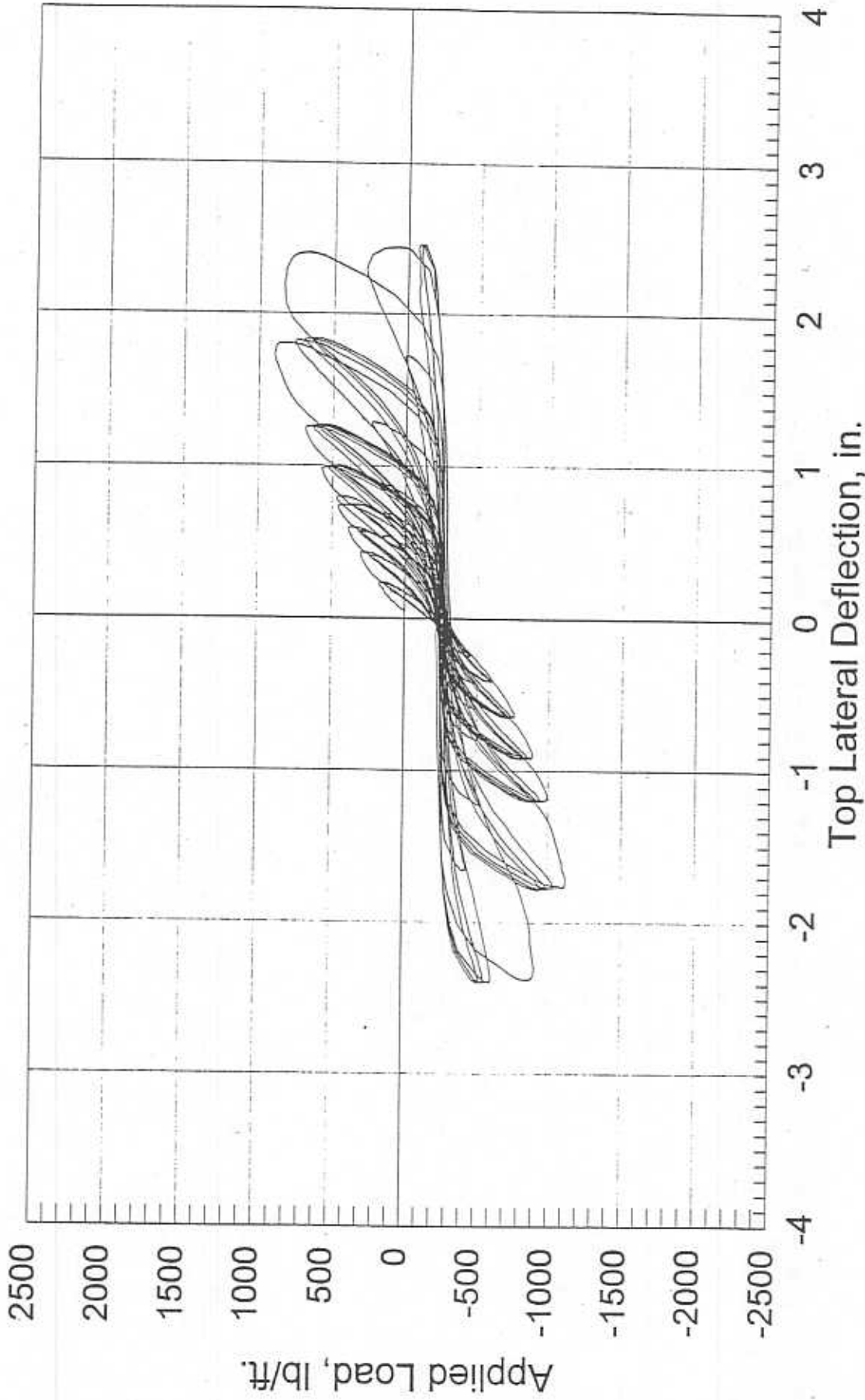

Fig. 35 Load vs. top of wall lateral displacement for specimen AISI-PLY1

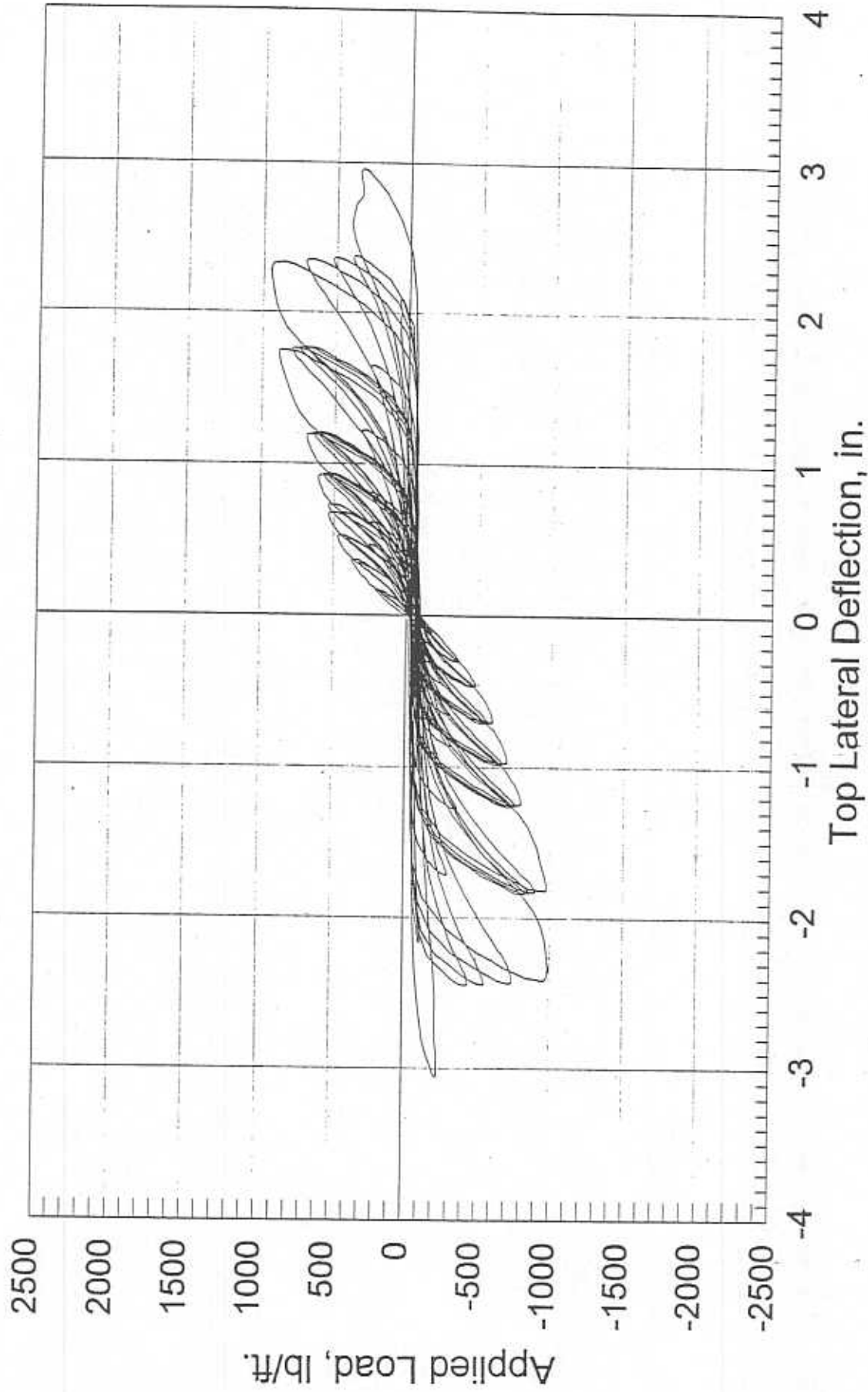

Fig. 36 Load vs. top of wall lateral displacement for specimen AISI-PLY2

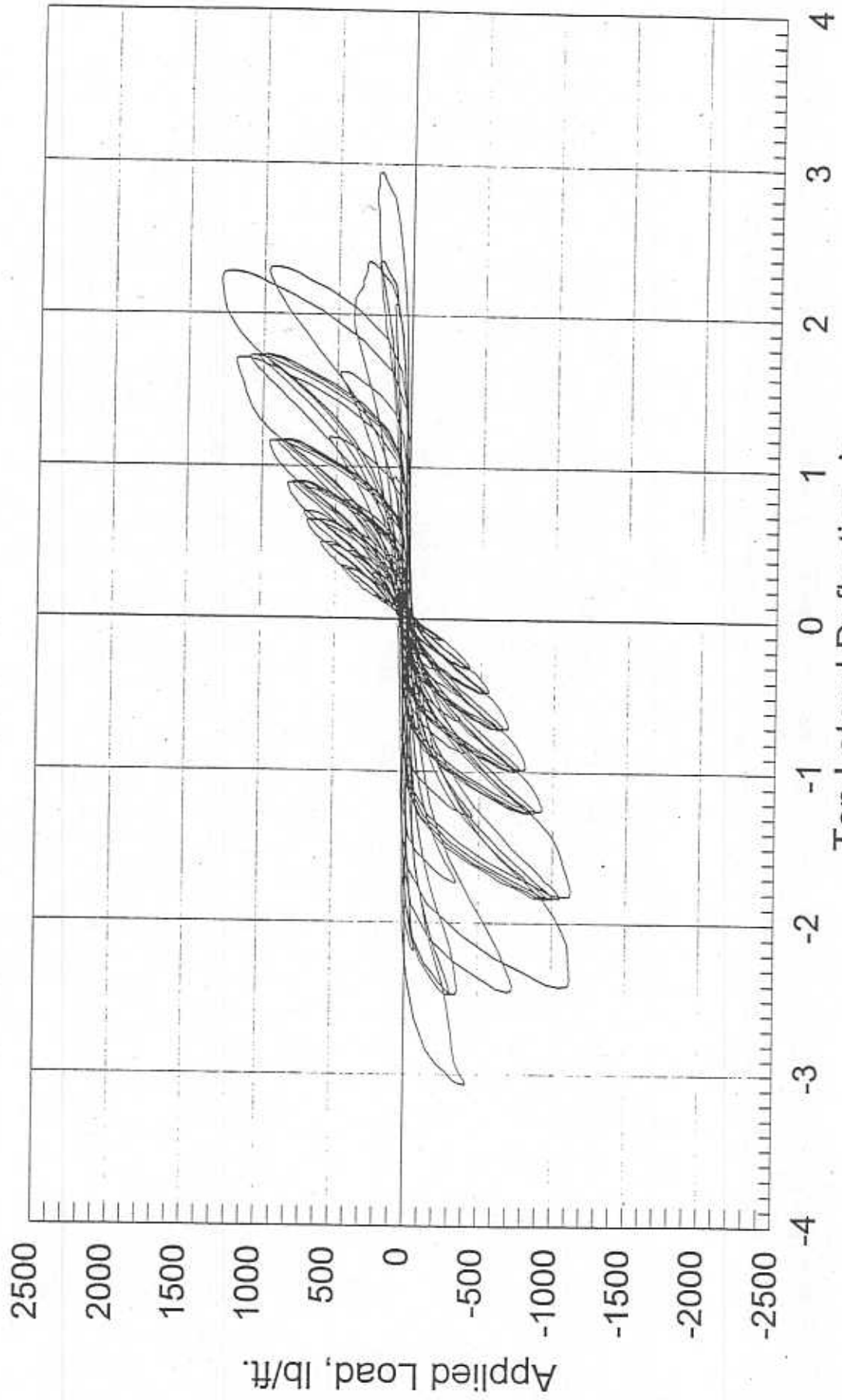

Fig. 37 Load vs. top of wall lateral displacement for specimen AISI-PLY3

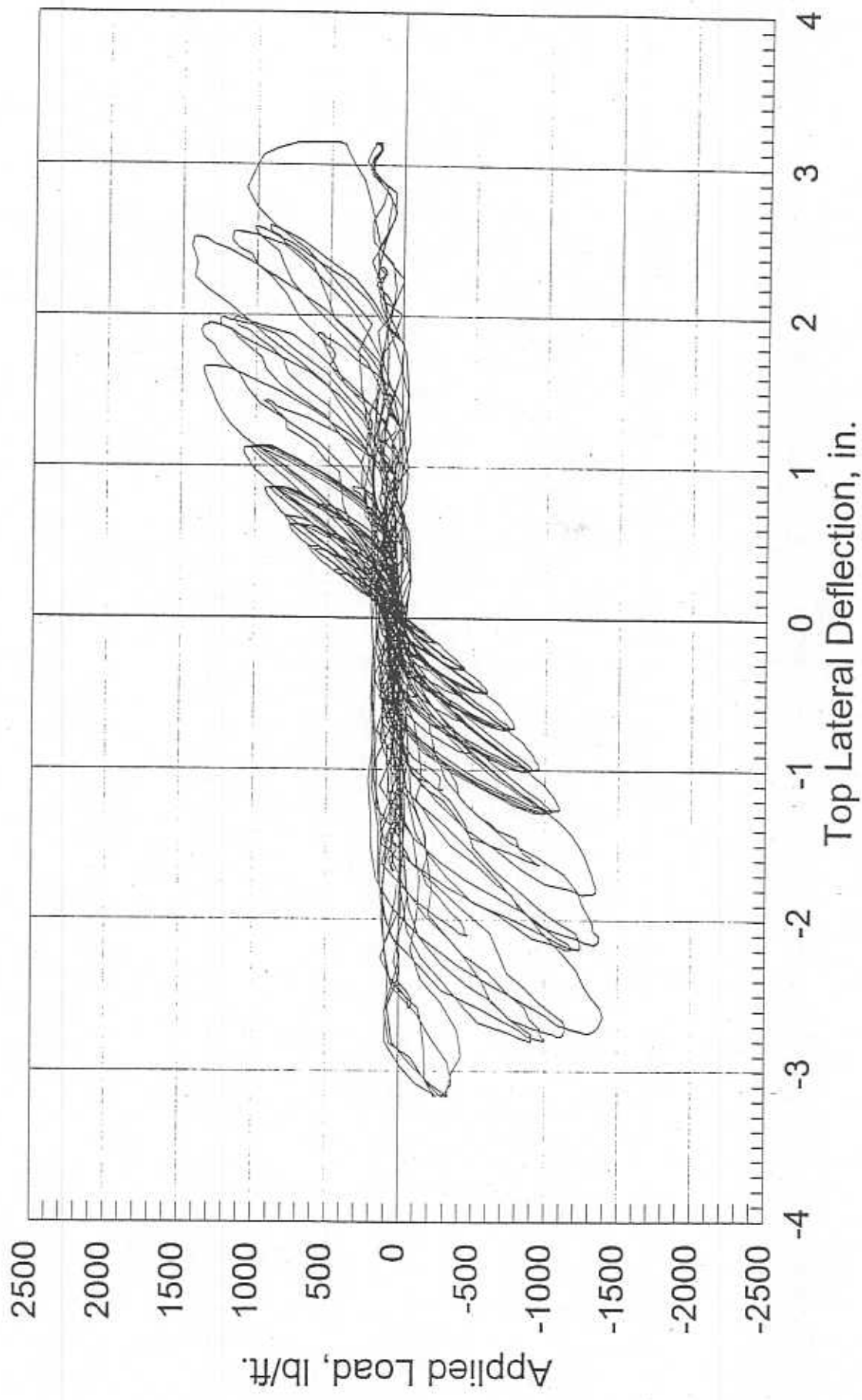

Fig. 38 Load vs. top of wall lateral displacement for specimen AISI-PLY4

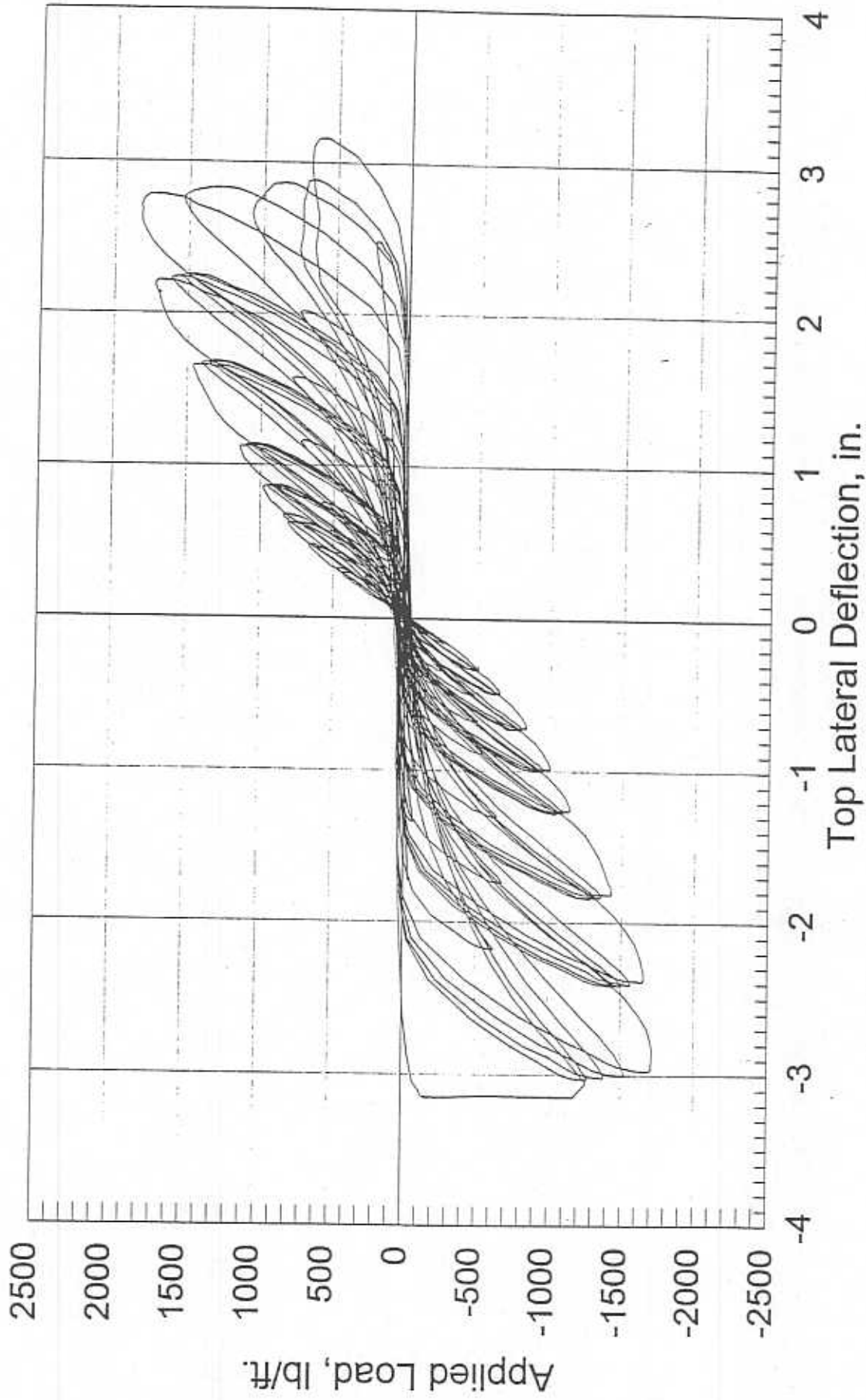

Fig. 39 Load vs. top of wall lateral displacement for specimen AISI-PLY5



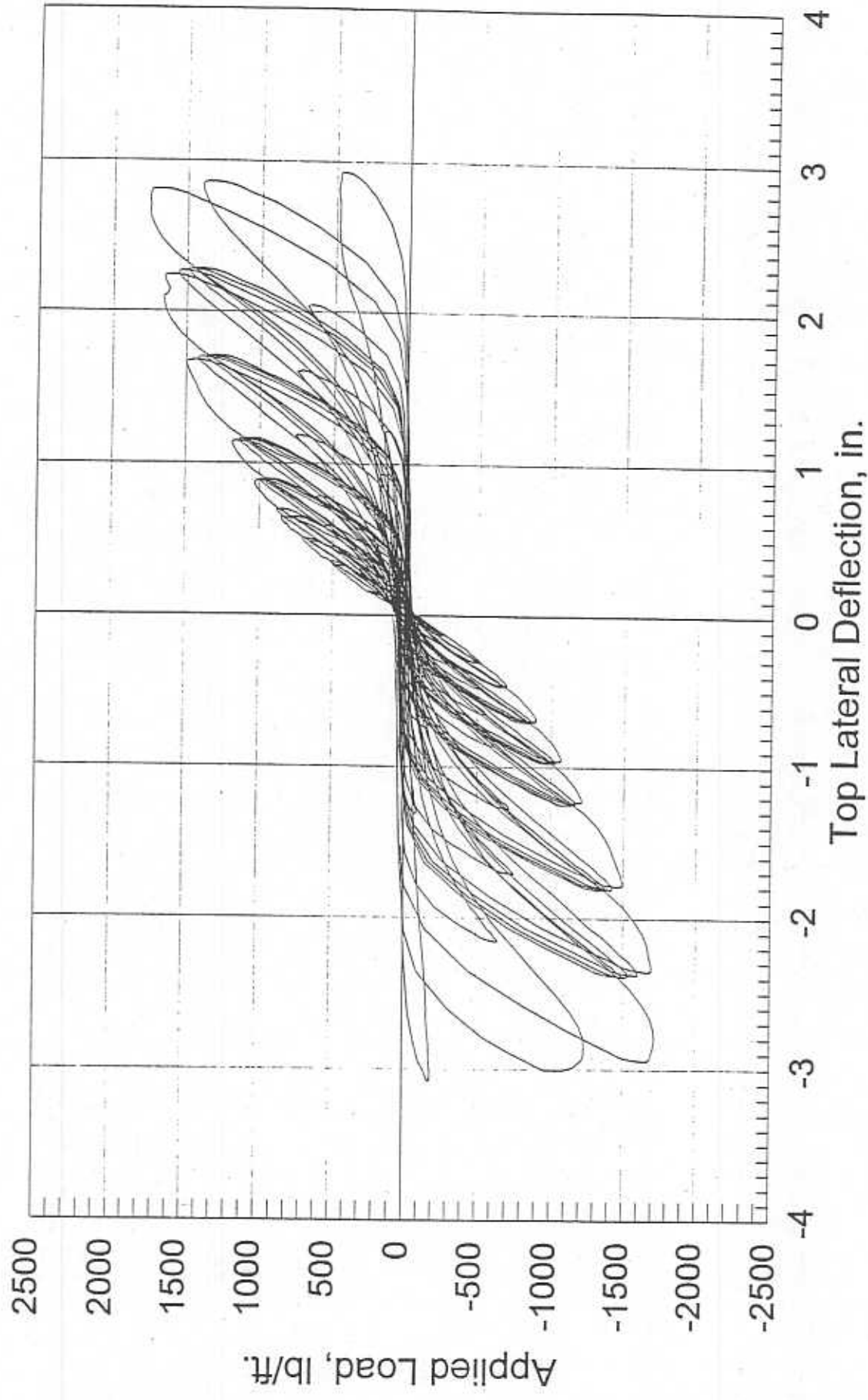

Fig. 40 Load vs. top of wall lateral displacement for specimen AISI-PLY6

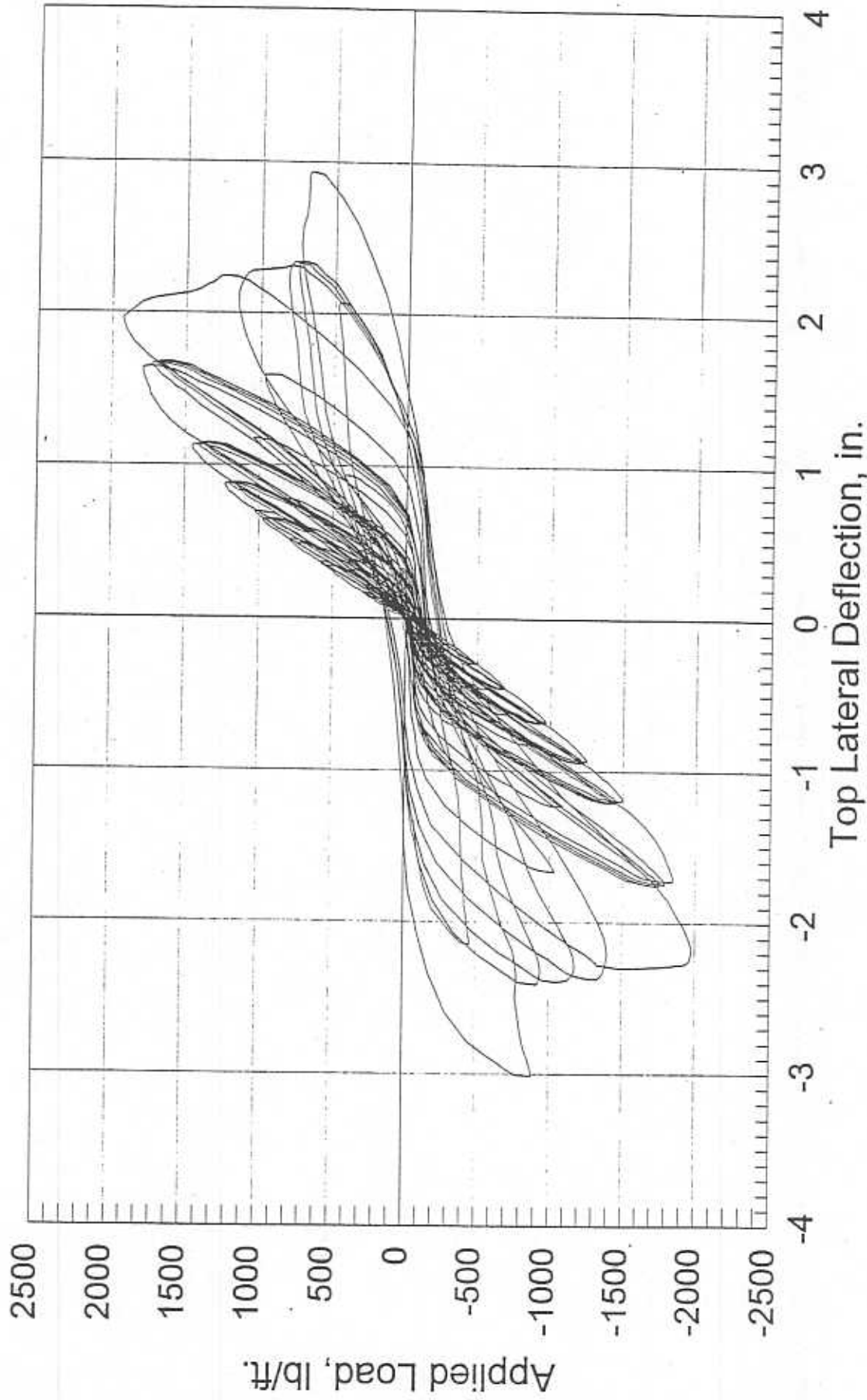

Fig. 41 Load vs. top of wall lateral displacement for specimen AISI-PLY7

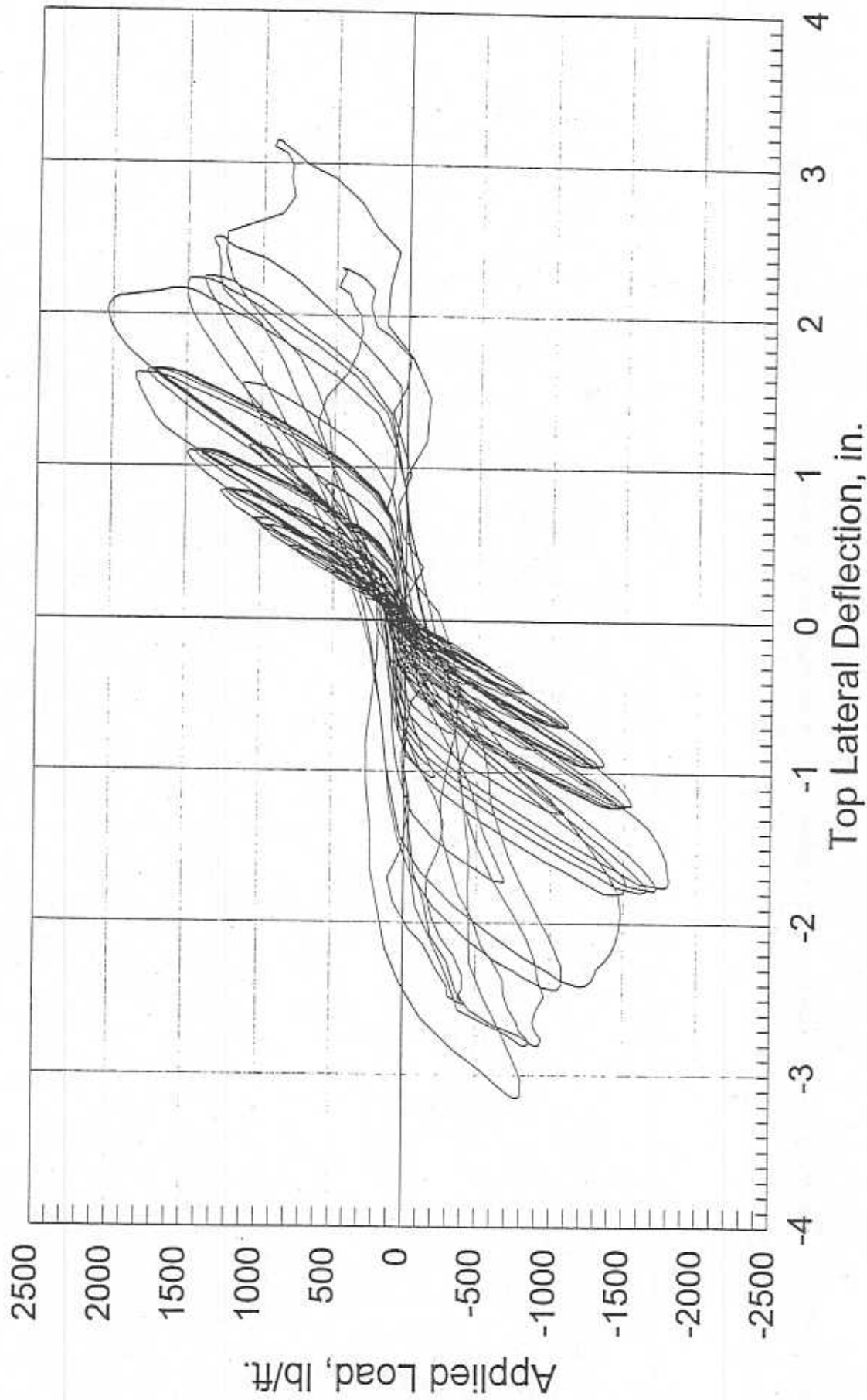
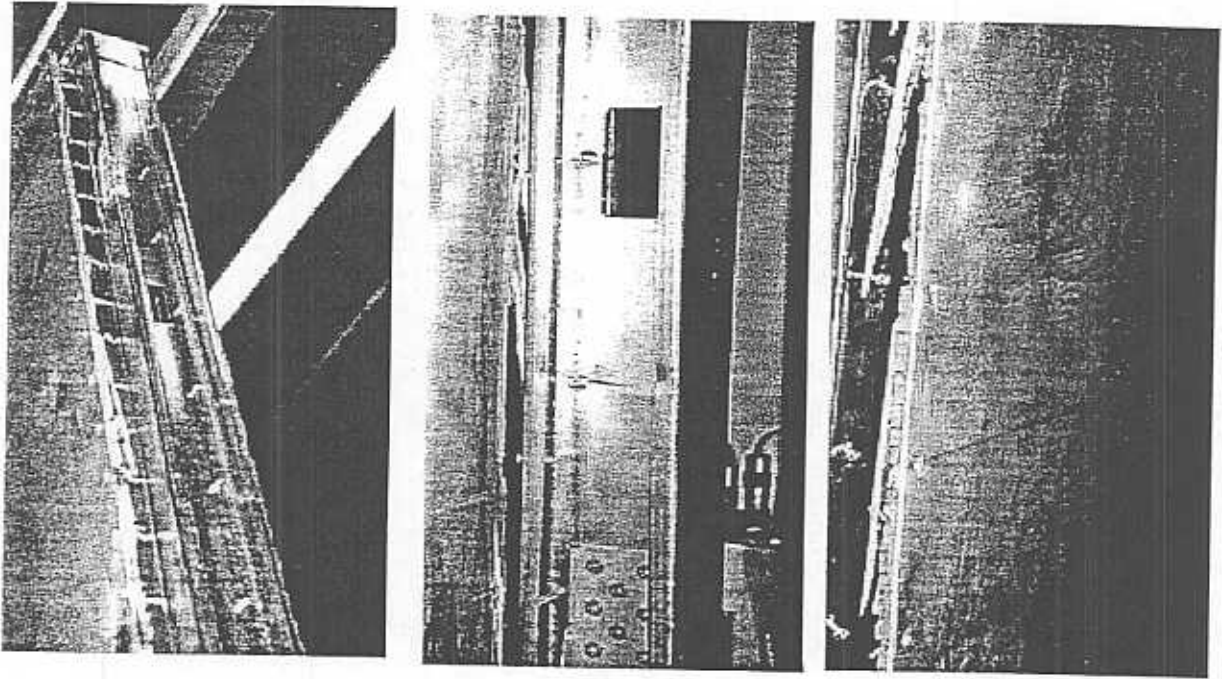

Fig. 42 Load vs. top of wall lateral displacement for specimen AISI-PLY8

## Appendix B

(Modes of Failure)



Panel failure in plywood walls (cyclic tests)

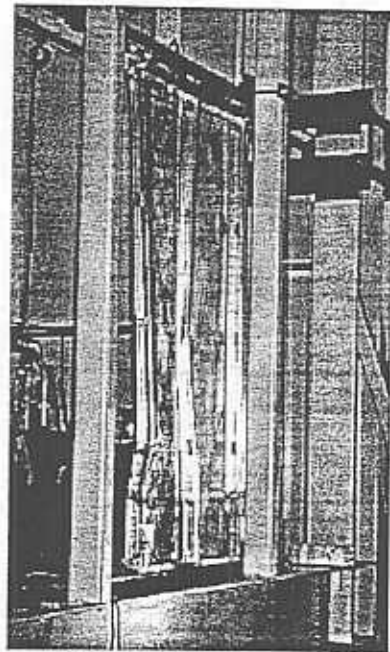

Chord stud failure in plywood walls (cyclic tests)

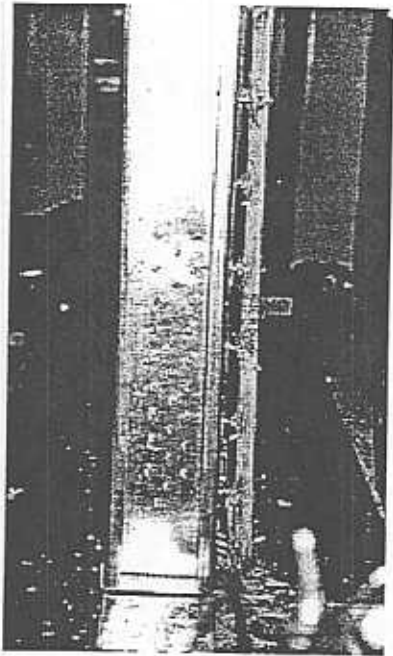

Panel failure in OSB walls  
(cyclic tests)

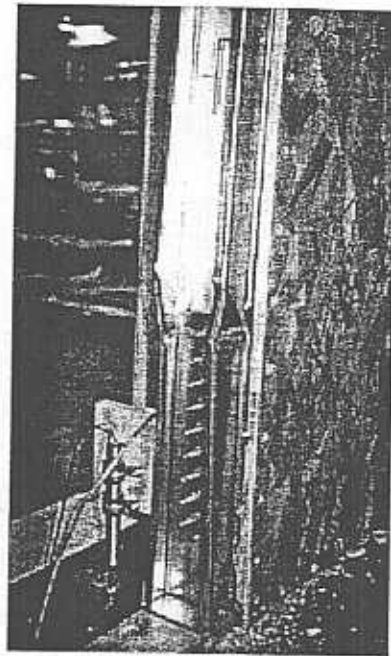

Chord stud failure in OSB walls  
(cyclic tests)

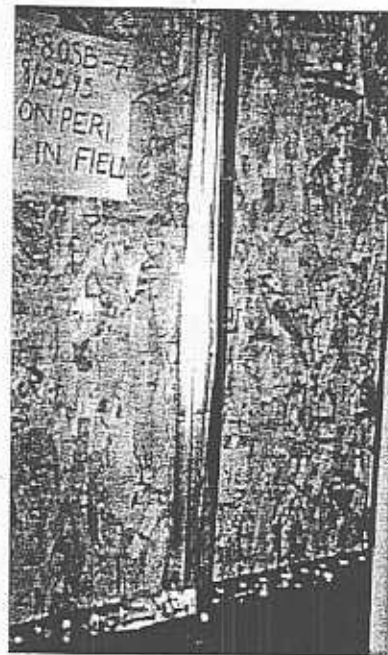

Interior stud buckling in OSB wall  
(cyclic tests)



**American Iron and Steel Institute**

1140 Connecticut Avenue, NW  
Suite 705  
Washington, DC 20036

[www.steel.org](http://www.steel.org)



**Steel Framing Alliance™**

*Steel. The Better Builder.*

1201 15<sup>th</sup> Street, NW  
Suite 320  
Washington, DC 20005

[www.steel framing.org](http://www.steel framing.org)

