

**Structural Design Example
– Four Span Metal Building
Z-Purlin Line Supporting a
Standing Seam Roof**

RESEARCH REPORT RP20-5

SEPTEMBER 2020

Committee on Specifications
for the Design of Cold-Formed
Steel Structural Members



American Iron and Steel Institute

The material contained herein has been developed by researchers based on their research findings. The material has also been reviewed by the American Iron and Steel Institute Committee on Specifications for the Design of Cold-Formed Steel Structural Members. The Committee acknowledges and is grateful for the contributions of such researchers.

The material herein is for general information only. The information in it should not be used without first securing competent advice with respect to its suitability for any given application. The publication of the information is not intended as a representation or warranty on the part of the American Iron and Steel Institute, or of any other person named herein, that the information is suitable for any general or particular use or of freedom from infringement of any patent or patents. Anyone making use of the information assumes all liability arising from such use.

September 2020

Copyright 2020 American Iron and Steel Institute

Structural Design Example — Four Span Metal Building Z-Purlin Line Supporting a Standing Seam Roof

By:

Cristopher D. Moen, Ph.D., P.E.

RunToSolve, LLC

September 2, 2020

PREFACE

In AISI S100-16, a new Section I6.1 was added that allows for the design of metal building roof purlin lines supporting a standing seam roof by analysis and calculation. This project provides an example step-by-step calculation of the new approach. The example purlin line structural analysis considers load eccentricity, roof slope, and bracing from the roof clips and roof diaphragm. Demand shear, moment, and torsion from the analysis are used to identify the controlling purlin line strength limit state (flexure+torsion, biaxial bending, flexure+shear, or distortional buckling), which then establishes the purlin line allowable gravity and uplift pressures. The example is automated with recently developed open-source software, and details of this software will be lightly introduced. Because the design example is automated by software, it is easy to perform sensitivity studies. The webinar that completed the project provided some discussion about how purlin line allowable gravity and uplift allowable pressures may vary with standing seam roof clip types (high vs. low, fixed vs. sliding), clip spacing, and roof slope.

The example is documented in a live calculation notebook:

(PDF version is provided in this report in the next 23 pages, and the markdown code printout follows after.)

<https://nextjournal.com/runtosolve/metal-building-standing-seam-roof-design-example>

The example uses open-source software to perform the calculations:

<https://github.com/runtosolve/StructuresKit.jl>

A webinar was presented to complete the project:

<https://youtu.be/uaHb2SGLahM>



by **Cris Moen** · Sep 02 2020 · PUBLISHED
with Cris Moen

Structural Design Example - Four Span Metal Building Z-Purlin Line Supporting a Standing Seam Roof

1. Introduction

This example provides a step-by-step strength calculation of a 4-span continuous Z-purlin system supporting a standing seam roof.

Design inputs are defined first, including cross-section dimensions and orientation, span lengths, roof slope, and bracing provided by the standing seam to the purlin line. The calculations consider gravity (downward) and suction (uplift) loadings.

2. Acknowledgements

The development of this notebook was financially supported by the American Iron and Steel Institute (<https://www.steel.org/>). Thank you to the task group members who offered thoughtful comments along the way.

3. How to use this notebook

This is a live calculation notebook. You can make a copy of it by pressing the 'Remix' button at the upper right corner of this browser window. Once you have the notebook copied to your Nextjournal account, you can run the calculation by clicking on the 'Double Arrows' at the top-left part of this browser window to the right of the Nextjournal logo.

4. Source code

The software package StructuresKit.jl (<https://github.com/runtosolve/StructuresKit.jl>) performs most of the structural analysis and design in this example. It is written in the Julia (<https://julialang.org/>) computing language. Plots.jl (<https://github.com/JuliaPlots/Plots.jl>) is used to make all the plots.

```
#load StructuresKit.jl from Github, use AISI2020webinar branch as suggested by  
Helen  
pkg"add https://github.com/runtosolve/StructuresKit.jl#AISI2020webinar";
```

✓ 66.0s

Julia [Julia 1.4.2](#)

```

[10c10a7d] + StructuresKit v0.1.0 #https://github.com/JuliaStructuresKit/StructuresKit.jl
[d1185830] + SymbolicUtils v0.5.1
[5d786b92] + TerminalLoggers v0.1.2
[a759f4b9] + TimerOutputs v0.5.6
[a2a6695c] + TreeViews v0.3.0
[3d5dd08c] + VectorizationBase v0.12.32
[02c8fc9c] ↑ XML2_jll v2.9.10+1 ⇒ v2.9.10+2
[83775a58] ↑ Zlib_jll v1.2.11+14 ⇒ v1.2.11+16
[3161d3a3] ↑ Zstd_jll v1.4.5+0 ⇒ v1.4.5+1

[700de1a5] + ZygoteRules v0.2.0
[0ac62f75] ↑ libass_jll v0.14.0+2 ⇒ v0.14.0+3
[f638f0a6] ↑ libfdk_aac_jll v0.1.6+2 ⇒ v0.1.6+3

```

```
using StructuresKit #start up the package so we can run its functions
```

✓ 324.1s

Julia [Julia 1.4.2](#)

```
using Plots #start up the package so we can run its functions
```

✓ 113.3s

Julia [Julia 1.4.2](#)

5. Design specification

Purlin line capacity is calculated with the AISI S100-16 (https://cfsei.memberclicks.net/index.php?option=com_mc&view=mc&mcid=form_259553) *North American Specification for the Design of Cold-Formed Steel Structural Members*.

6. Allowable Stress Design (ASD)

Allowable Stress Design (ASD) is used to calculate the purlin line failure pressures.

```
ASDorLRFD=0; #ASDorLRFD=0 for ASD, =1 for LRFD
```

✓ 0.2s

Julia [Julia 1.4.2](#)

7. Units

Consistent units of kips and inches and degrees are used for inputs. Output units are labeled.

8. Roof system definitions and inputs

8.1. Purlin span geometry

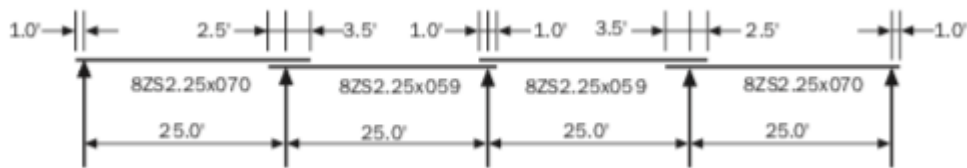

Figure 1: 4 span continuous Z-purlin line dimensions and layout

The standing seam roof is supported by continuous span Z-purlin lines with a typical center-to-center span length of 25 ft. The exterior spans are 8ZS2.25x070 purlins, and the interior spans are 8ZS2.25x059 purlins. The purlins overhang the end supports by 1 ft., and they are spliced at supports with the dimensions provided in Figure 1. This span layout is consistent with AISI D100 (<https://shop.steel.org/products/cold-formed-steel-design-manual-2017-edition-electronic-version-includes-aisi-s100-16-specification-and-commentary>) *Cold-Formed Steel Design Manual* Example II-2A.

```
#The purlin line are discretized on grid.
#Each row defines one segment of the beam span from left to right.

#L dL SectionProperties MaterialProperties LoadLocation BracingProperties
CrossSectionDimensions

#L is the length of each beam segment
#each beam segment is split into subsegments of length dL

MemberDefinitions = [(1.0*12,2.0,    1,1,1,1,1),
                    (22.5*12,6.0,    1,1,1,1,1),
                    (6.0*12,6.0,     3,1,1,1,3),
                    (20.5*12,6.0,    2,1,2,1,2),
                    (2*12,3.0,       4,1,2,1,4),
                    (20.5*12,6.0,    2,1,2,1,2),
                    (6.0*12,6.0,     3,1,1,1,3),
                    (22.5*12,6.0,    1,1,1,1,1),
                    (1.0*12,2.0,     1,1,1,1,1)];
```

8.2. Roof loading

Gravity and uplift roof pressures are considered.

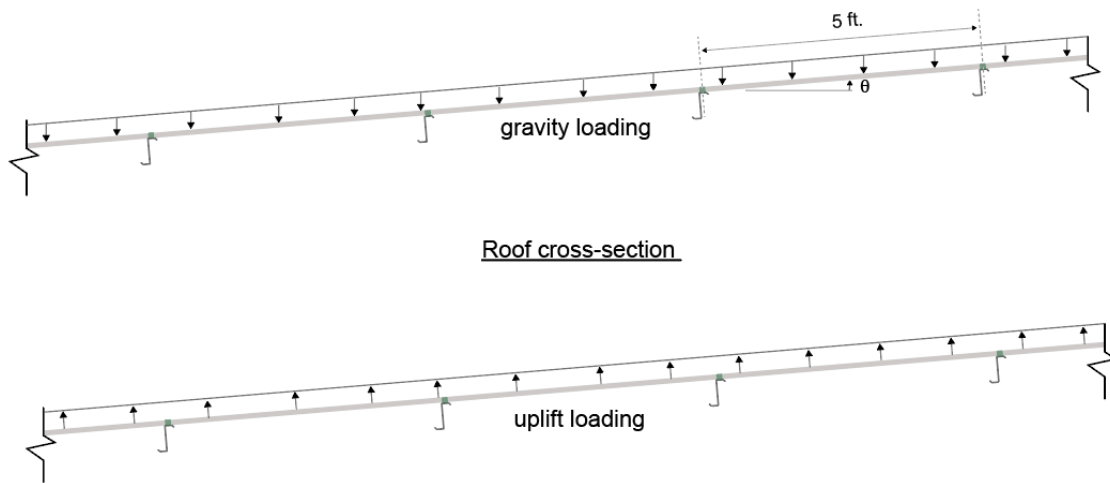

Figure 2: Roof cross-sections, one purlin and a roof tributary width are considered

8.3. Purlin spacing

The purlin spacing for this example is 5 ft.

```
PurlinSpacing=5*12; #in.
```

8.4. Roof slope

The roof slope $\theta=4.76$ degrees (1:12), with the purlin flange pointing upslope.

```
#theta
RoofSlope = 4.76; #degrees
```

8.5. Supports and end boundary conditions

It is assumed that translations and rotations are restrained at every span support and the cantilever ends are free ends.

```
#location z where u=v=phi=0
Supports = [1.0*12 26.0*12 51.0*12 76.0*12 101.0*12];

#end boundary conditions
#type=1 u''=v''=phi''=0 (simply supported), type=2 u'=v'=phi'=0 (fixed), type=3
u''=v''=phi''=u'''=v'''=phi'''=0 (free end, e.g., a cantilever)
EndBoundaryConditions = [3 3];
```

8.6. Purlin cross-section properties

There are two purlin cross-sections in the purlin line, 8ZS2.25x070 and 8ZS2.25x059. The centroidal axis moment of inertias about the centroid are I_x and I_y , the product of inertias, I_{xy} , and the warping and St. Venant torsion constants C_w and J are taken from AISI D100 Table I-4. The interior and exterior purlin splice section properties are assumed to be the summation of the section properties of the spliced members.

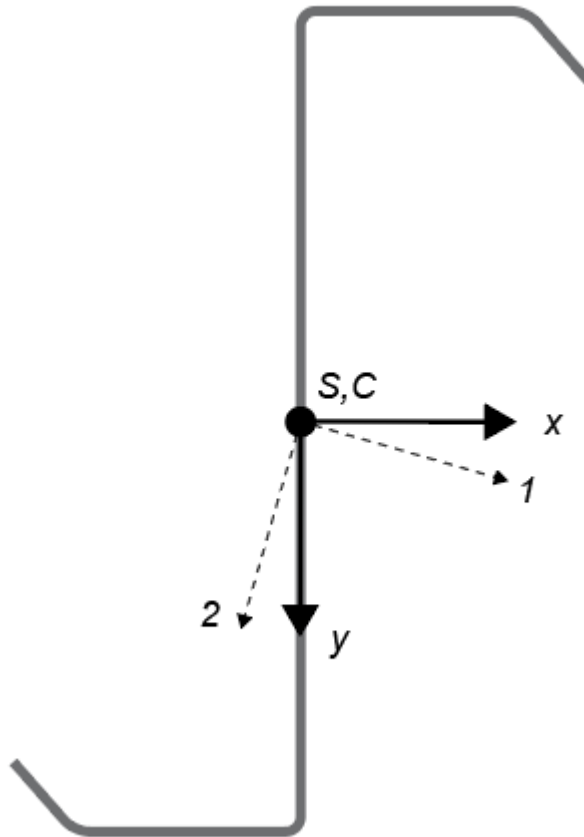

Figure 3: Cross-section coordinate systems, 1-2 are the principal axes

```
#Each row below defines a set of section properties. There are 4 rows because
there are 4 cross-sections in this example - 8ZS2.25x070, 8ZS2.25x059,
8ZS2.25x070+ 8ZS2.25x059 at a splice, and 8ZS2.25x059+8ZS2.25x059 at a splice.
```

```
#Ix Iy Ixy J Cw Wn Mcrlx Mcrly
```

```
SectionProperties = [
```

```
    (9.18,1.28,-2.47,0.00159,15.1, 151.86, 66.33),
    (7.76,1.08,-2.08,0.000954,12.7, 91.48, 40.06),
    (9.18+7.76,1.28+1.08,-(2.47+2.08),0.00159+0.000954, (15.1+12.7)*2,
151.86+91.48, 66.33+40.06),
    (7.76*2,1.08*2,-2.08*2,0.000954*2,12.7*4, 2*91.48, 2*40.06)];
```

The unit warping stress W_n is multiplied by 4 in the spliced regions because otherwise the AISI bending+torsion interaction equation predicts failure. More work is needed to determine how to consider bimoment in the design of spliced regions.

I_{xy} is negative here because the AISI D100 coordinate system has y pointing up however the PlautBeam coordinate system has y pointing down.

The critical elastic buckling moments M_{crx} and M_{crl} were calculated with CUFSM. In the future they could be calculated in this notebook (or in an software workflow) using evolving open-source packages like pyCUFSM (<https://github.com/ClearCalcs/pyCUFSM>).

8.7. Purlin cross-section dimensions

Cross-section dimensions for each of the 4 cross-sections in this example are needed for calculating distortional buckling capacity and shear capacity.

```
#t is base metal thickness
#ho, b, d, and h are outside purlin depth, flange width, lip length, and web
flat height
#θ is lip angle from the horizontal
#CorZ=0 for C, CorZ=1 for Z
#This nomenclature is consistent with AISI S100-16.

#t, ho, b, d, θ, CorZ, h
CrossSectionDimensions =
[(0.070, 8.0, 2.25, 0.930, 50, 1, 7.560),
 (0.059, 8.0, 2.25, 0.910, 50, 1, 7.582),
 (0.070+0.059, 8.0, 2.25, 0.910, 50, 1, 7.56),
 (0.059*2, 8.0, 2.25, 0.910, 50, 1, 7.582)];
```

8.8. Distributed load location

The distributed load, q , is applied at the center of the top flange. The variables a_x and a_y are the x and y distances from the shear center to the load application point. The x -axis is parallel to the roof and the y -axis is perpendicular to the roof.

The angle of the load q to the purlin flange varies. For gravity loading q is always vertical. For an uplift loading, q is always perpendicular to the purlin top flange.

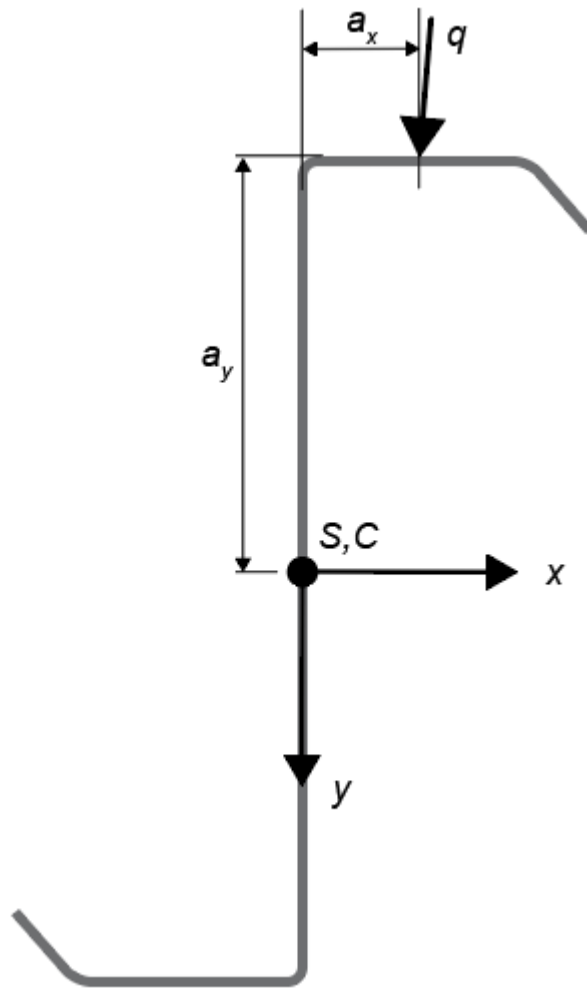

Figure 4: Load location, q is always perpendicular to the flange for an uplift loading and vertical for a gravity loading

```
#ax ay
```

```
LoadLocation = [((2.250-0.070/2)/2,4), ((2.250-0.059/2)/2,4)];
```

8.9. Purlin material properties

Typical material properties for cold-formed steel are assumed.

```
#E v Fy
```

```
MaterialProperties = [(29500,0.30, 55)];
```

8.10. System bracing details

A standing seam roof with a trapezoidal profile is assumed. The roof is attached to the purlins with low fixed clips at a spacing of 24 in.

The distributed rotational stiffness provided to the purlin by the roof is obtained from clip-panel tests described in Seek and Laughlin (2017) (https://cfsei.memberclicks.net/assets/docs/research_report/RP18-3_Determination%20of%20Effective%20Standoff%20in%20SSRS_s.pdf) Table A2.1.

The distributed translational stiffness provided to the purlin by the roof is inspired by results from gravity open-web joist tests partially braced by a standing seam roof described in Cronin and Moen (2012) (<https://vtechworks.lib.vt.edu/handle/10919/18711>).

It is assumed that k_x for gravity loads is twice that of uplift loads because for gravity loads the roof tends to 'hug' the clips.

More work is needed to quantify in-situ standing seam roof clip stiffness.

The roof diaphragm shear stiffness is assumed to be much higher than the lateral clip stiffness and therefore only the clip stiffnesses affect the purlin deformations in this example. A springs-in-series model could be constructed using recent research (<https://jscholarship.library.jhu.edu/handle/1774.2/62114>) to study the impact of the roof diaphragm on purlin design.

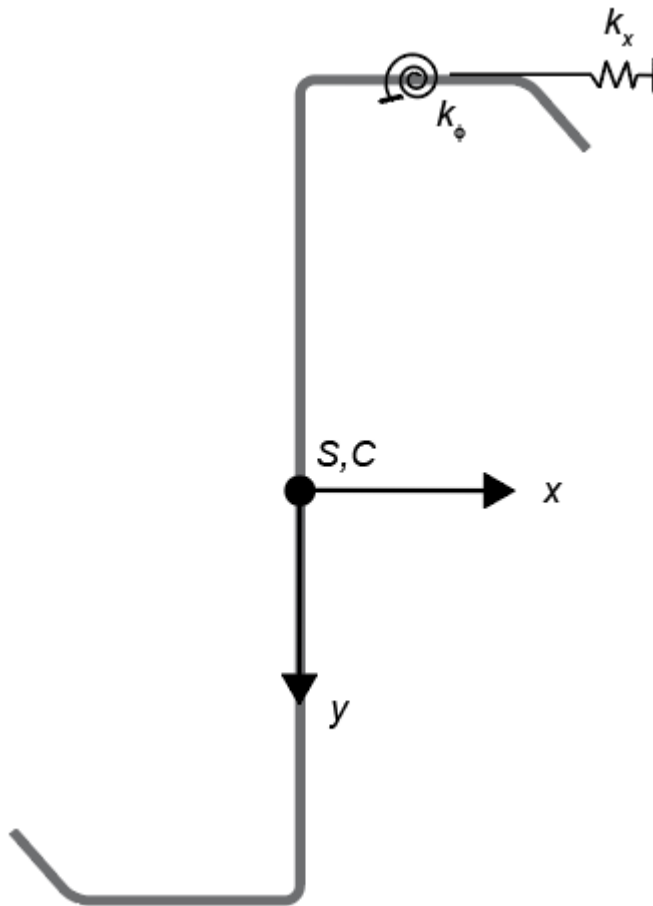

Figure 5: Springs attached to the top flange, k_x always acts parallel to the x-axis

```
#kx kphi Lm a
#kx has units of kips/in./in., and kphi of kips-in./rad/in.
#Lm is the spacing between bracing that restrains distortional buckling
#a is the web shear stiffener spacing, assumed equal to the span length here
since none are provided
BracingProperties = [(0.100,0.100, 25.0*12, 25.0*12)];
```

The bracing properties above are for the gravity load case. They will be updated later in the example for the uplift case.

With all inputs defined, we can now calculate standing seam roof system capacity.

9. Roof capacity under gravity loading

9.1. Deflections

When the standing seam roof carries a downward gravity pressure, downward forces are applied to the center of the purlin top flange at the clips as shown in Figure 6 which creates bending and twist deformations. Let's review these deformations for a gravity roof pressure of 10 psf. They are calculated with elastic second order analysis using the Plaut and Moen (2020) (<https://cloud.aisc.org/SSRC/43PlautandMoen2020SSRC.pdf>) formulation.

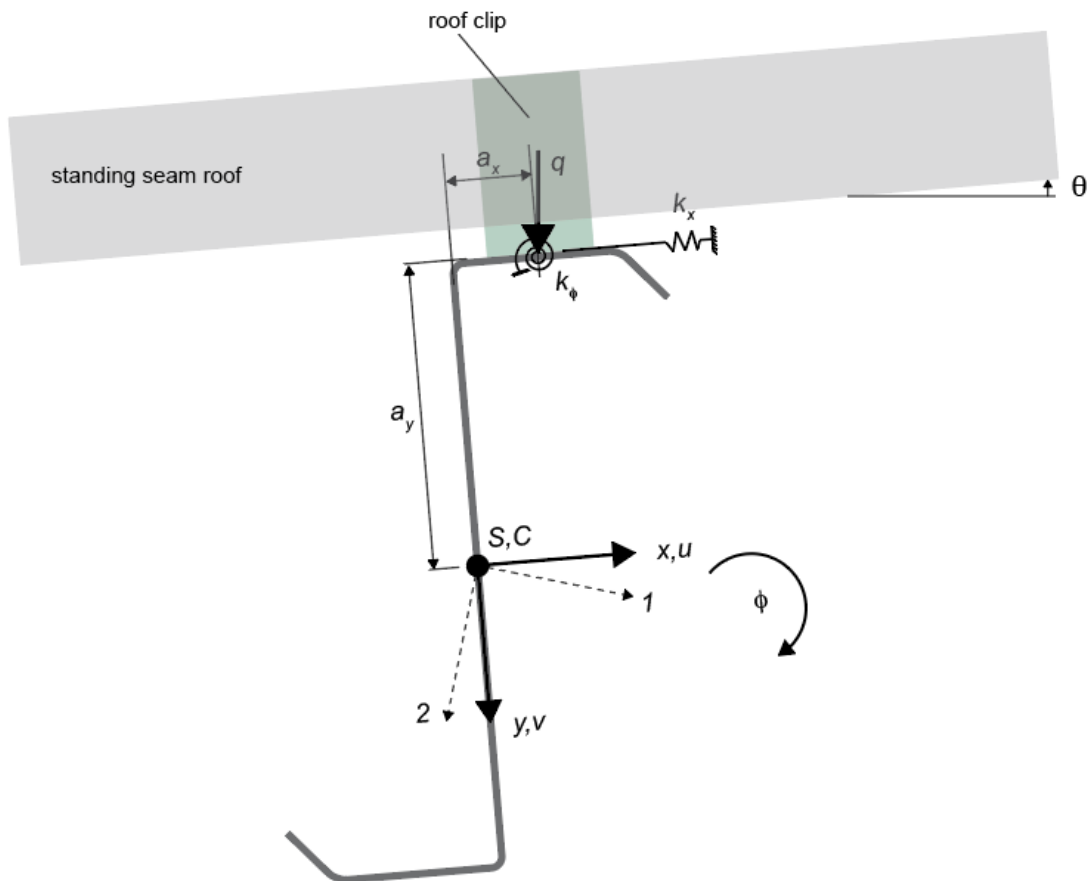

Figure 6: Gravity load structural analysis, q is vertical, z -axis is into the page

```
#Solve for the purlin line deformations
#10 psf pressure
Pressure=10/1000/144 #kips/in.^2

q=Pressure*PurlinSpacing*cos(deg2rad(RoofSlope)) #cosine here for slope
qx = -q*sin(deg2rad(RoofSlope))
qy = q*cos(deg2rad(RoofSlope))
UniformLoad=(qx,qy)
```

```
z, u, v,  $\phi$ , beamProperties = PlautBeam.solve(MemberDefinitions,  
SectionProperties, MaterialProperties, LoadLocation, BracingProperties,  
EndBoundaryConditions, Supports, UniformLoad);
```

```
plot(z/12,u, legend=false, markershape= :circle)  
ylabel!("u [in.]")  
xlabel!("z [ft.]")
```

```
plot(z/12,v, legend=false)  
ylabel!("v [in.]")  
xlabel!("z [ft.]")
```

```
plot(z/12,rad2deg( $\phi$ ), legend=false)  
ylabel!("phi [degrees]")  
xlabel!("z [ft.]")
```

9.2. Demand moments, shear and torsion

The moments about the cross-section centroidal axes, torsion, bimoment, and shear on the centroidal axes can be calculated from these deformations.

```
Mxx = InternalForces.moment(z, beamProperties.dm, -v, beamProperties.E,  
beamProperties.Ix);  
Myy = InternalForces.moment(z, beamProperties.dm, -u, beamProperties.E,  
beamProperties.Iy);  
Vyy = InternalForces.shear(z, beamProperties.dm, -v, beamProperties.E,  
beamProperties.Ix);  
Vxx = InternalForces.shear(z, beamProperties.dm, -u, beamProperties.E,  
beamProperties.Iy);  
T = InternalForces.torsion(z, beamProperties.dm,  $\phi$ , beamProperties.E,  
beamProperties.G, beamProperties.J, beamProperties.Cw);  
B = InternalForces.bimoment(z, beamProperties.dm,  $\phi$ , beamProperties.E,  
beamProperties.Cw);
```

Positive moments, shear and torsion follow the nomenclature in the figure below.

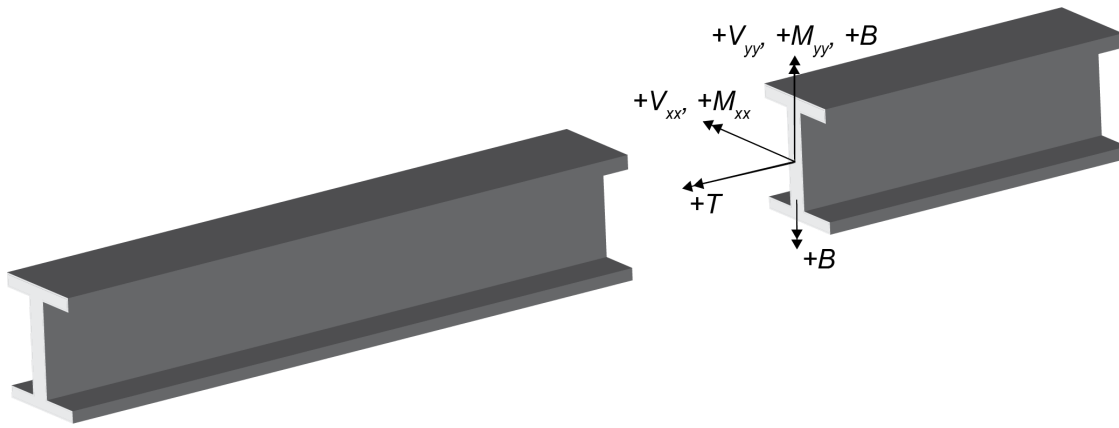

Figure 7: Sign convention for internal forces and moments, see cut in the beam

```
plot(z/12,Mxx, legend=false)
ylabel!("Mxx [kip-in.]")
xlabel!("z [ft.]")
```

```
plot(z/12,Vyy, legend=false)
ylabel!("Vyy [kips]")
xlabel!("z [ft.]")
```

```
plot(z/12,Myy, legend=false)
ylabel!("Myy [kip-in.]")
xlabel!("z [ft.]")
```

```
plot(z/12,Vxx, legend=false)
ylabel!("Vxx [kips]")
xlabel!("z [ft.]")
```

```
plot(z/12,T, legend=false)
ylabel!("T [kip-in.]")
xlabel!("z [ft.]")
```

```
plot(z/12,B, legend=false)
ylabel!("B [kip-in.^2]")
xlabel!("z [ft.]")
```

9.3. Purlin strength limit state checks

The expected strength of the purlin line is defined when one of 4 strength limit states are violated along the spans: (1) distortional buckling, (2) bending+torsion interaction, (3) biaxial bending, or (4) bending+shear. The checks are performed with elastic demand shears, moments and torsion considering second order effects and connection stiffness as specified in AISI S100-16 Section C1 "Design for System Stability".

1. The distortional buckling capacity is calculated with AISI S100-16 Eq. F4.1-1, where the critical elastic distortional buckling stress F_{crd} is obtained using AISI S100-16 Appendix 2, Eq. 2.3.3.3-1 assuming the standing seam clips do not provide rotational restraint, i.e., $k_\phi = 0$ in Eq. 2.3.3.3-1. The distance between discrete restraints that restrain distortional buckling is defined as the span length, i.e., $L_m = 25$ ft. in Section 7.8 above. Since M_{nd} is calculate about the x - axis, the demand that it is compared to is M_{xx} when defining failure.
2. The bending+torsion interaction check is defined in AISI S100-24 Eq. H4.2-1:

$$\frac{\overline{M}_x}{M_{axlo}} + \frac{\overline{M}_y}{M_{aylo}} + \frac{\overline{B}}{B_a} \leq 1.15$$

The demand moments $\overline{M}_x = M_{xx}$ and $\overline{M}_y = M_{yy}$ with trends consistent with those in Section 8.2. The expected local buckling strengths are calculated with AISI S100-16 Section F.3.2.1 where $M_{axlo} = M_{nlx}/\Omega_b$ and $M_{aylo} = M_{nly}/\Omega_b$. The critical elastic local buckling moments M_{crlx} and M_{crlly} are calculated with CUFSM and defined in Section 7.6.

The demand bimoment is \overline{B} (again see Section 8.2) and $B_a = B_n/\Omega_b$ is calculated with AISI S100-24 Eq. H4.1-1:

$$B_n = F_y C_w / W_n$$

where W_n is the maximum magnitude of cross-section unit warping calculated in CUFSM and defined in Section 7.4 and $\Omega_b = 1.67$.

3. The biaxial bending strength limit state is checked with AISI S100-16 Eq. H1.2-1.
4. The bending+shear strength limit state is evaluated with AISI S100-16 Eq. H2-1.

Other interaction checks could be considered here instead of those listed above. For example, Prof. Seek's recent work on calculating stresses on the cross-section including flexure and torsion and applying the Direct Strength Method are in play.

Global buckling as defined in the Direct Strength Method is considered in the second-order analysis and interaction checks, not with a critical elastic buckling load. So here there is no M_{cre} calculated for gravity loads, or for the uplift load case next.

9.4. Purlin line capacity under gravity loading

Failure in the purlin line is calculated by increasing the roof pressure until one of the strength limit states is violated.

```
GravityOrUplift=0 #GravityOrUplift=0 for gravity loading
```



```

eqn, z, strengths, forces, interactions, dc =
PurlinDesigner.lineStrength(ASDorLRFD, GravityOrUplift, MemberDefinitions,
SectionProperties, CrossSectionDimensions, MaterialProperties, LoadLocation,
BracingProperties, RoofSlope, EndBoundaryConditions, Supports)

```

```

FailurePressure=eqn/(PurlinSpacing*cos(deg2rad(RoofSlope)))*1000*144

```

```

println("ASD expected gravity roof capacity =
",round(FailurePressure,digits=1), " psf")

```

```

plot(z/12,dc.dist, legend=false)
plot!([0, 102],[1.0, 1.0], linecolor=:red, linewidth=2)
ylabel!("Distortional buckling demand/capacity ratio")
xlabel!("z [ft.]")
ylims!((0,1.41))
xlims!((0,102))

```

```

plot(z/12,interactions.BTotal, label="Interaction")
plot!(z/12, interactions.BTMxx, label="ActionMxx")
plot!(z/12, interactions.BTMy, label="ActionMy")
plot!(z/12, interactions.BTB, label="ActionB")
plot!([0, 102],[1.15, 1.15], label="Limit", linecolor=:red, linewidth=2)
ylabel!("Flexure+torsion interaction")
xlabel!("z [ft.]")
ylims!((0,1.41))
xlims!((0,102))

```

```

plot(z/12,interactions.BBTotal, label="Interaction")
plot!(z/12, interactions.BBMxx, label="ActionMxx")
plot!(z/12, interactions.BBMy, label="ActionMy")
plot!([0, 102],[1.0, 1.0], label="Limit", linecolor=:red, linewidth=2)
ylabel!("Biaxial bending")
xlabel!("z [ft.]")
ylims!((0,1.41))
xlims!((0,102))

```

```

plot(z/12,dc.MV, legend=false)
plot!([0, 102],[1.0, 1.0], linecolor=:red, linewidth=2)
ylabel!("Shear+flexure demand/capacity ratio")
xlabel!("z [ft.]")
ylims!((0,1.41))
xlims!((0,102))

```

9.5. Purlin line capacity trends under gravity loading

The purlin line failure pressure under gravity loading is calculated with varying lateral and rotational bracing stiffness to show its influence on failure pressure.

```

kx=[0.0:0.02:0.1;0.15:0.05:1.0]
kphi=0.0:0.05:0.1

eqn=zeros(length(kx),length(kphi))
for i in eachindex(kx)
    for j in eachindex(kphi)

        BracingProperties=[(kx[i],kphi[j],25.0*12, 25.0*12)]

        eqn[i,j], z, strengths, forces, interactions, dc =
PurlinDesigner.lineStrength(ASDorLRFD, GravityOrUplift, MemberDefinitions,
    SectionProperties, CrossSectionDimensions, MaterialProperties, LoadLocation,
    BracingProperties, RoofSlope, EndBoundaryConditions, Supports)

    end
end

```

```

FailurePressure=eqn./(PurlinSpacing.*cos.(deg2rad(RoofSlope))) .*1000 .*144;

```

```

plot(kx,FailurePressure[:,1], markershape=:circle, label="kphi=0.0")
plot!(kx,FailurePressure[:,2], markershape=:square, label="kphi=0.05")
plot!(kx,FailurePressure[:,3], markershape=:diamond, label="kphi=0.10")

```

```
ylabel!("ASD expected gravity roof capacity [psf]")
xlabel!("kx [kips/in./in.]")
```

Another interesting study is to vary the roof slope and observe its effect on purlin line strength.

```
BracingProperties=[(0.100,0.100,25.0*12, 25.0*12)]

RoofSlope=rad2deg.(atan.(0.0:(0.5/12):(4/12)))

eqn=zeros(length(RoofSlope))
for i in eachindex(RoofSlope)
    eqn[i], z, strengths, forces, interactions, dc =
PurlinDesigner.lineStrength(ASDorLRFD, GravityOrUplift, MemberDefinitions,
    SectionProperties, CrossSectionDimensions, MaterialProperties, LoadLocation,
    BracingProperties, RoofSlope[i], EndBoundaryConditions, Supports)
end
```

```
FailurePressure=eqn./(PurlinSpacing.*cos.(deg2rad.(RoofSlope))) .*1000 .*144;
```

```
plot(RoofSlope, FailurePressure, markershape=:circle, legend=false)

ylabel!("ASD expected gravity roof capacity [psf]")
xlabel!("Roof slope [degrees]")
ylims!((0,25))
```

10. Roof capacity under uplift loading

10.1. Deflections

When the standing seam roof carries an uplift pressure, clip forces normal to the roof face are applied to the center of the purlin top flange which creates bending and twist deformations that are different than the gravity loading. Let's review these deformations for an uplift roof pressure of -10 psf.

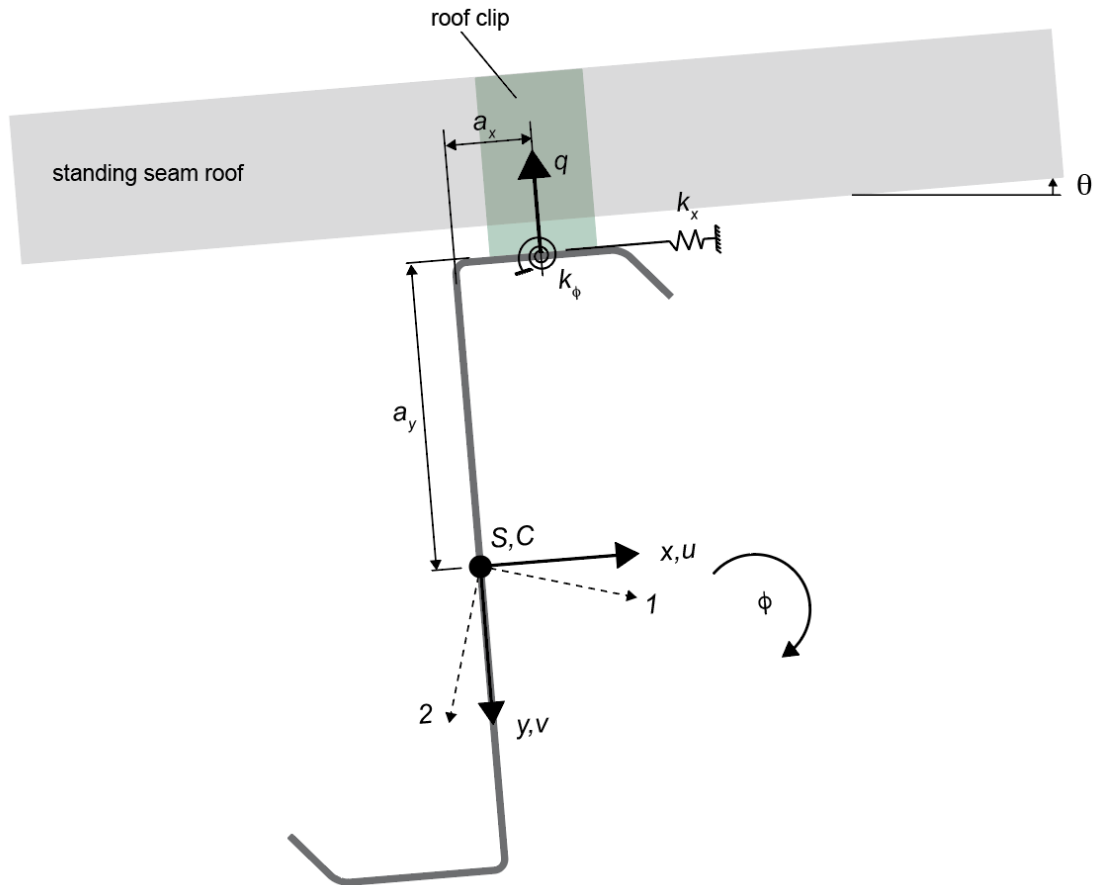

Figure 7: Uplift structural analysis, q is perpendicular to the flange

```

RoofSlope=0.0 #this sets the load perpendicular to the roof for uplift loading

#reduce kx by half for uplift loading, no hugging
BracingProperties = [(0.100/2,0.100, 25.0*12, 25.0*12)];

#Solve for the purlin line deformations
#-10 psf pressure load
Pressure=-10/1000/144 #kips/in.^2

q=Pressure*PurlinSpacing
qx = -q*sin(deg2rad(RoofSlope))
qy = q*cos(deg2rad(RoofSlope))
UniformLoad=(qx,qy)

z, u, v, phi, beamProperties = PlautBeam.solve(MemberDefinitions,
SectionProperties, MaterialProperties, LoadLocation, BracingProperties,
EndBoundaryConditions, Supports, UniformLoad);

```

```
plot(z/12,u, legend=false)
ylabel!("u [in.]")
xlabel!("z [ft.]")
```

```
plot(z/12,v, legend=false)
ylabel!("v [in.]")
xlabel!("z [ft.]")
```

```
plot(z/12,rad2deg.( $\phi$ ), legend=false)
ylabel!("phi [degrees]")
xlabel!("z [ft.]")
```

10.2. Demand moments and torsion

The moments about the cross-section centroidal axes, torsion, bimoment, and shear on the centroidal axes can be calculated from these deformations.

```
Mxx = InternalForces.moment(z, beamProperties.dm, -v, beamProperties.E,
beamProperties.Ix);
Myy = InternalForces.moment(z, beamProperties.dm, -u, beamProperties.E,
beamProperties.Iy);
Vyy = InternalForces.shear(z, beamProperties.dm, -v, beamProperties.E,
beamProperties.Ix);
Vxx = InternalForces.shear(z, beamProperties.dm, -u, beamProperties.E,
beamProperties.Iy);
T = InternalForces.torsion(z, beamProperties.dm,  $\phi$ , beamProperties.E,
beamProperties.G, beamProperties.J, beamProperties.Cw);
B = InternalForces.bimoment(z, beamProperties.dm,  $\phi$ , beamProperties.E,
beamProperties.Cw);
```

```
plot(z/12,Mxx, legend=false)
ylabel!("Mxx [kip-in.]")
xlabel!("z [ft.]")
```

```
plot(z/12,Vyy, legend=false)
ylabel!("Vyy [kips]")
xlabel!("z [ft.]")
```

```
plot(z/12,Myy, legend=false)
ylabel!("Myy [kip-in.]")
xlabel!("z [ft.]")
```

```
plot(z/12,Vxx, legend=false)
ylabel!("Vxx [kips]")
xlabel!("z [ft.]")
```

```
plot(z/12,T, legend=false)
ylabel!("T [kip-in.]")
xlabel!("z [ft.]")
```

```
plot(z/12,B, legend=false)
ylabel!("B [kip-in.^2]")
xlabel!("z [ft.]")
```

10.3. Purlin strength limit state checks

In the same way as for gravity pressures (see Section 8.3), failure in the purlin line is assumed to occur at the location where the demand loads first exceed the distortional buckling capacity or violate the bending+torsion interaction check, a biaxial bending check, or a shear+moment interaction check.

10.4. Purlin line capacity under uplift loading

Failure in the purlin line is calculated by increasing the roof pressure until a limit state is violated.

```
GravityOrUplift=1 #GravityOrUplift=1 for uplift loading
```

```
eqn, z, strengths, forces, interactions, dc =
PurlinDesigner.lineStrength(ASDorLRFD, GravityOrUplift, MemberDefinitions,
```

```
SectionProperties, CrossSectionDimensions, MaterialProperties, LoadLocation,  
BracingProperties, RoofSlope, EndBoundaryConditions, Supports)
```

```
FailurePressure=eqn/PurlinSpacing*1000*144
```

```
println("ASD expected uplift roof capacity = ",round(FailurePressure,digits=1),  
" psf")
```

```
plot(z/12,dc.dist, legend=false)  
plot!([0, 102],[1.0, 1.0], linecolor=:red, linewidth=2)  
ylabel!("Distortional buckling demand/capacity ratio")  
xlabel!("z [ft.]")  
ylims!((0,1.41))  
xlims!((0,102))
```

```
plot(z/12,interactions.BTTotals, label="Interaction")  
plot!(z/12, interactions.BTMxx, label="ActionMxx")  
plot!(z/12, interactions.BTMyy, label="ActionMyy")  
plot!(z/12, interactions.BTB, label="ActionB")  
plot!([0, 102],[1.15, 1.15], label="Limit", linecolor=:red, linewidth=2)  
ylabel!("Flexure+torsion interaction")  
xlabel!("z [ft.]")  
ylims!((0,1.41))  
xlims!((0,102))
```

```
plot(z/12,interactions.BBTotals, label="Interaction")  
plot!(z/12, interactions.BBMxx, label="ActionMxx")  
plot!(z/12, interactions.BBMyy, label="ActionMyy")  
plot!([0, 102],[1.0, 1.0], label="Limit", linecolor=:red, linewidth=2)  
ylabel!("Biaxial bending")  
xlabel!("z [ft.]")  
ylims!((0,1.41))  
xlims!((0,102))
```

```

plot(z/12,dc.MV, legend=false)
plot!([0, 102],[1.0, 1.0], linecolor=:red, linewidth=2)
ylabel!("Shear+flexure demand/capacity ratio")
xlabel!("z [ft.]")
ylims!((0,1.41))
xlims!((0,102))

```

10.5. Purlin line capacity trends under uplift loading

The purlin line failure pressure under uplift loading is calculated with varying bracing conditions to show what influences the calculated failure pressure.

```

kx=[0.0:0.02:0.1;0.15:0.05:0.3]
kphi=0.0:0.05:0.1

eqn=zeros(length(kx),length(kphi))
for i in eachindex(kx)
    for j in eachindex(kphi)

        BracingProperties=[(kx[i],kphi[j],25.0*12, 25.0*12)]

        eqn[i,j], z, strengths, forces, interactions, dc =
PurlinDesigner.lineStrength(ASDorLRFD, GravityOrUplift, MemberDefinitions,
    SectionProperties, CrossSectionDimensions, MaterialProperties, LoadLocation,
    BracingProperties, RoofSlope, EndBoundaryConditions, Supports)

    end

end

```

```

FailurePressure=eqn./PurlinSpacing .*1000 .*144;

```

```

plot(kx,FailurePressure[:,1], markershape=:circle, label="kphi=0.0")
plot!(kx,FailurePressure[:,2], markershape=:square, label="kphi=0.05")
plot!(kx,FailurePressure[:,3], markershape=:diamond, label="kphi=0.10")

ylabel!("ASD expected uplift roof capacity [psf]")

```



```
xlabel!("kx [kips/in./in.]")  
ylims!(-22.0, 0.0)
```

11. Conclusions

This example highlights how the AISI specification, the Direct Strength Method, and open-source software can be used to calculate the strength of a purlin line supporting a standing seam roof in a metal building.

- Distortional buckling in the exterior spans is the controlling limit state for a gravity loading. This could be remedied by decreasing the standing seam roof clip spacing.
- Bending+torsion interaction at the first interior support is the controlling limit state for an uplift loading. The purlin flanges get worked hard in the splice region as the purlin twists and bends.
- Purlin line strength gets big help from small amounts of lateral stiffness k_x . Rotational stiffness is less important.

12. Ongoing Work

Work continues on the following:

- add a local buckling calculator to this workflow
- shell finite verification studies of PlautBeam solutions including translational and rotational springs
- add pattern loads and point loads
- add discrete springs that could be used to model intermediate bracing
- make this workflow accessible with an API
- increase calculation speed and efficiency in preparation for optimization and machine learning studies
- add 3D visualization and a web UI

13. Appendix - verification studies

Verification studies of the AISI10016 module are performed as unit test sets on GitHub, see the /tests folder. Critical elastic local and distortional buckling are verified with CUFSM, and Direct Strength Method calculations are verified with a spreadsheet downloaded from the Hopkins Thin-Walled Structures Group website.

Verification studies of the PlautBeam module include first order analysis deflections and internal forces that were confirmed to match MASTAN2. It was determined that any further second order analysis verification with MASTAN2 did not make sense since it is not very easy to include distributed springs and the second order formulation is for doubly-symmetric I-sections, especially the Lagrangian body-fixed coordinate system terms in the geometric stiffness matrix.

Some verification of the PlautBeam module has been completed with shell finite element analysis in LS-DYNA (<http://lstc.com/products/ls-dyna>) for the case of a single span Z purlin under gravity load studied in Example 2 of Plaut and Moen (2020). "Lateral-Torsional Deformations of C-Section and Z-Section Beams with Continuous Bracing." (<https://cloud.aisc.org/SSRC/43PlautandMoen2020SSRC.pdf>) The first study with $k_x = k_\phi = 0$ predicted consistent u , v , and ϕ to LS-DYNA under gravity loads.

The second LS-DYNA gravity load second study with $k_x = k_\phi = 0$, $a_x = 27.826$ mm (1.096 in.), and $a_y = 101.6$ mm (4.0 in.) showed that PlautBeam underpredicted u , v , and ϕ compared to shell finite element analysis by as much as 70%, compare u of 2.0 mm to 1.3 mm, and $\phi = 0.020$ radians to 0.013 radians. This difference is partially because of cross-section deformation that occurs when the load is applied to the flange, and partially because PlautBeam uses a space-fixed coordinate system for its second-order analysis instead of a body-fixed coordinate system. Even though the deformations are underpredicted by PlautBeam, it is expected that the internal moments and torsion calculated from the LS-DYNA deformations will be consistent with PlautBeam because they are dependent upon changes in the deformations, not the absolute magnitudes.

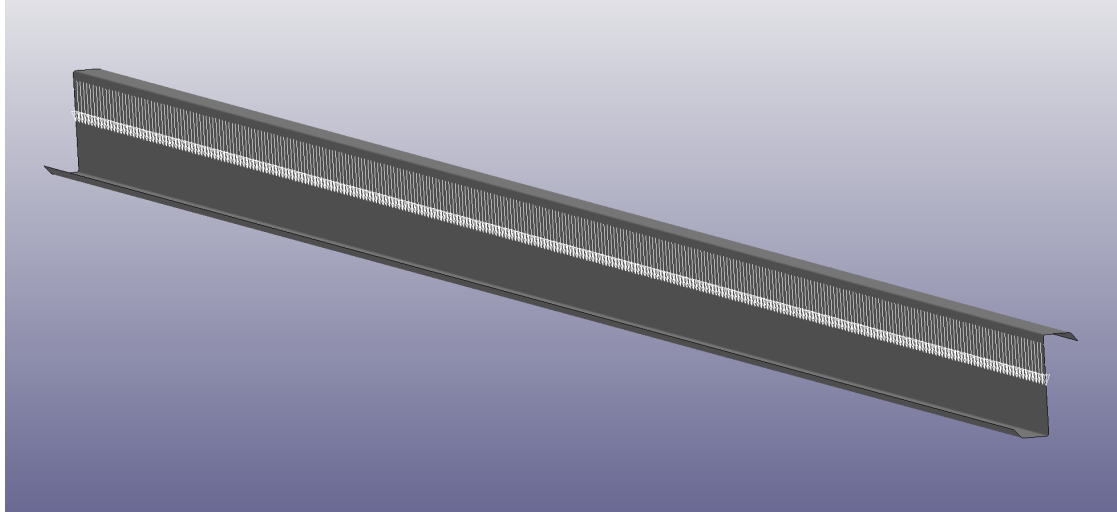

Figure 8: Gravity uniform load at shear center of purlin, Example 2 Plaut and Moen (2020).

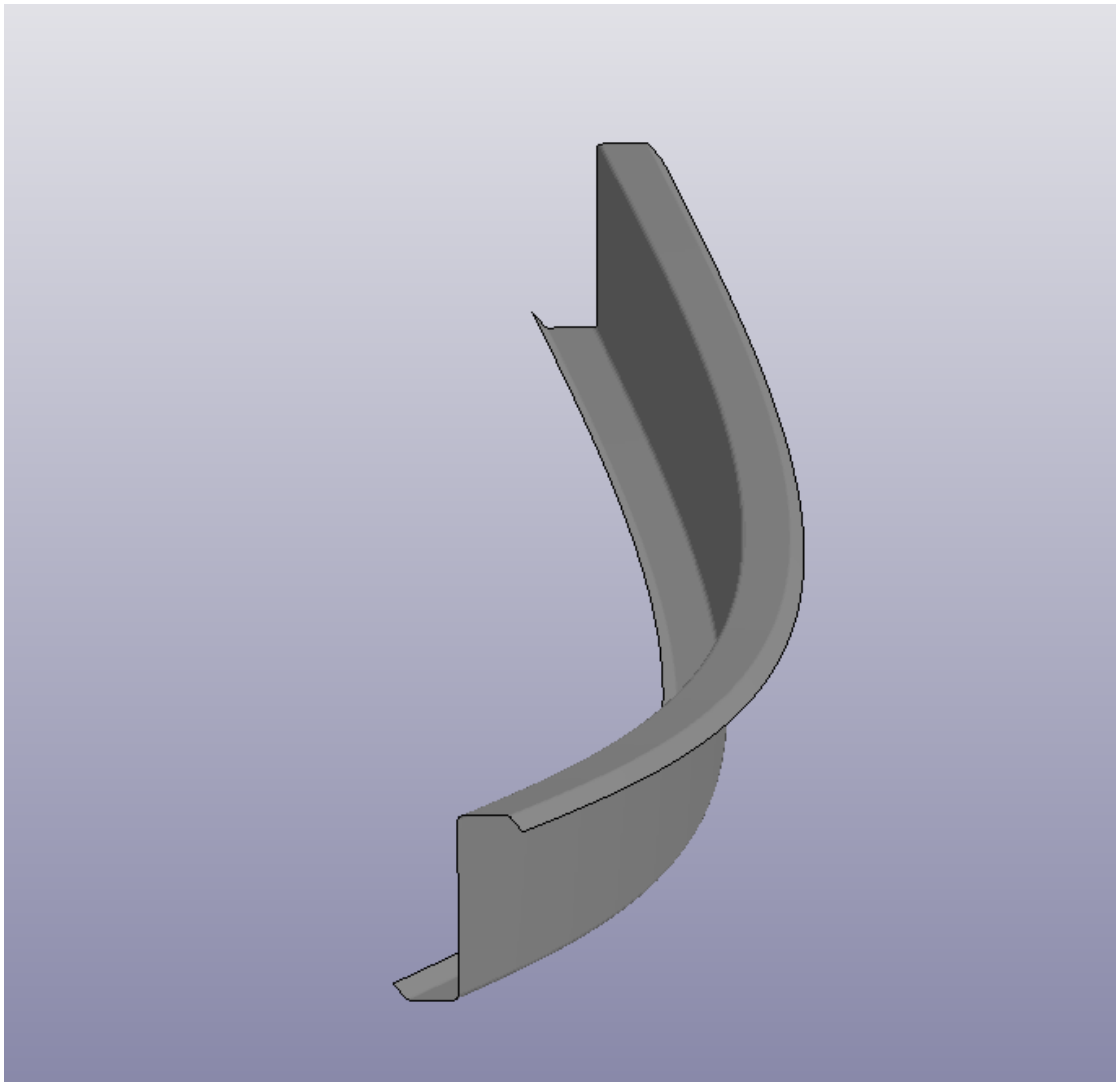

Figure 9: Deformed shape from uniform gravity, load at shear center, no springs

A study is also underway that will compare flexural capacity predictions from PurlinDesigner with existing simple span purlin tests supporting a screw fastened roof. This study will be presented at the Cold-Formed Steel Research Consortium Colloquium (<https://cfsrc.org/2020/08/06/colloquium-preliminary-program/>) coming up in November 2020.

► Runtimes (1)

Structural Design Example - Four Span Metal Building Z-Purlin Line Supporting a Standing Seam Roof

Introduction

This example provides a step-by-step strength calculation of a 4-span continuous Z-purlin system supporting a standing seam roof.

Design inputs are defined first, including cross-section dimensions and orientation, span lengths, roof slope, and bracing provided by the standing seam to the purlin line. The calculations consider gravity (downward) and suction (uplift) loadings.

Acknowledgements

The development of this notebook was financially supported by the [American Iron and Steel Institute](https://www.steel.org/). Thank you to the task group members who offered thoughtful comments along the way.

How to use this notebook

This is a live calculation notebook. You can make a copy of it by pressing the 'Remix' button at the upper right corner of this browser window. Once you have the notebook copied to your Nextjournal account, you can run the calculation by clicking on the 'Double Arrows' at the top-left part of this browser window to the right of the Nextjournal logo.

Source code

The software package [StructuresKit.jl](https://github.com/runtosolve/StructuresKit.jl) performs most of the structural analysis and design in this example. It is written in the [Julia](https://julialang.org/) computing language. [Plots.jl](https://github.com/JuliaPlots/Plots.jl) is used to make all the plots.

```
```julia id=e5ea95df-6529-4a77-b596-5ac52d667f58
#load StructuresKit.jl from Github, use AISI2020webinar branch as suggested by Helen
pkg"add https://github.com/runtosolve/StructuresKit.jl#AISI2020webinar";
```
```

```
```julia id=29863b0f-4b40-4fea-8b88-b63c8924f2c1
using StructuresKit #start up the package so we can run its functions
```
```

```
```julia id=8044fd0f-2259-4f38-86c4-8db5619d9499
using Plots #start up the package so we can run its functions
```
```

Design specification

Purlin line capacity is calculated with the [AISI S100-16](https://cfsei.memberclicks.net/index.php?option=com_mc&view=mc&mcid=form_259553) **North American Specification for the Design of Cold-Formed Steel Structural Members**.

Allowable Stress Design (ASD)

Allowable Stress Design (ASD) is used to calculate the purlin line failure pressures.

```
```julia id=ce800e8c-2b9b-4d38-982a-655693dd0a51
ASDorLRFD=0; #ASDorLRFD=0 for ASD, =1 for LRFD
```
```

Units

Consistent units of kips and inches and degrees are used for inputs. Output units are labeled. [↗](#)

Roof system definitions and inputs

Purlin span geometry

```
![spanlayout.png][nextjournal#file#17b302b6-df36-4c3f-8fd6-95a84810822f]
```

The standing seam roof is supported by continuous span Z-purlin lines with a typical center-to-center span length of 25 ft. The exterior spans are 8ZS2.25x070 purlins, and the interior spans are 8ZS2.25x059 purlins. The purlins overhang the end supports by 1 ft., and they are spliced at supports with the dimensions provided in Figure 1. This span layout is consistent with [\[AISI D100\]](https://shop.steel.org/products/cold-formed-steel-design-manual-2017-edition-electronic-version-includes-aisi-s100-16-specification-and-commentary) (<https://shop.steel.org/products/cold-formed-steel-design-manual-2017-edition-electronic-version-includes-aisi-s100-16-specification-and-commentary>) **Cold-Formed Steel Design Manual** Example II-2A. [↗](#)

```
```julia id=ce18a234-afba-432b-a008-04c05c692318
```

```
#The purlin line are discretized on grid.
```

```
#Each row defines one segment of the beam span from left to right.
```

```
#L dL SectionProperties MaterialProperties LoadLocation BracingProperties
CrossSectionDimensions ↗
```

```
#L is the length of each beam segment
```

```
#each beam segment is split into subsegments of length dL
```

```
MemberDefinitions = [(1.0*12,2.0, 1,1,1,1,1),
 (22.5*12,6.0, 1,1,1,1,1),
 (6.0*12,6.0, 3,1,1,1,3),
 (20.5*12,6.0, 2,1,2,1,2),
 (2*12,3.0, 4,1,2,1,4),
 (20.5*12,6.0, 2,1,2,1,2),
 (6.0*12,6.0, 3,1,1,1,3),
 (22.5*12,6.0, 1,1,1,1,1),
 (1.0*12,2.0, 1,1,1,1,1)];
```
```

Roof loading

Gravity and uplift roof pressures are considered.

![RoofCrossSectionr1.png][nextjournal#file#b0ddfd92-c2ad-4f05-9f45-d136dcca5db9]

Purlin spacing

The purlin spacing for this example is 5 ft.

```
```julia id=e0abdd6b-49c6-4932-b99c-a0bbf6ad8b94
PurlinSpacing=5*12; #in.
```
```

Roof slope

The roof slope $\theta=4.76$ degrees (1:12), with the purlin flange pointing upslope.

```
```julia id=1cf90000-29cd-4e73-9fd0-c5866ebe44d8
#θ
RoofSlope = 4.76; #degrees
```
```

Supports and end boundary conditions

It is assumed that translations and rotations are restrained at every span support and the cantilever ends are free ends. ↗

```
```julia id=43a0861c-d555-4abd-be66-eed1801292fd
#location z where u=v=φ=0
Supports = [1.0*12 26.0*12 51.0*12 76.0*12 101.0*12];
```

#end boundary conditions

```
#type=1 u''=v''=φ''=0 (simply supported), type=2 u'=v'=φ'=0 (fixed), type=3
u''=v''=φ''=u'''=v'''=φ'''=0 (free end, e.g., a cantilever)
EndBoundaryConditions = [3 3];
```
```

Purlin cross-section properties

There are two purlin cross-sections in the purlin line, 8ZS2.25x070 and 8ZS2.25x059. The centroidal axis moment of inertias about the centroid are I_x and I_y , the product of inertias, I_{xy} , and the warping and St. Venant torsion constants C_w and J are taken from AISI D100 Table I-4. The interior and exterior purlin splice section properties are assumed to be the summation of the section properties of the spliced members. ↗

![axes.png][nextjournal#file#c8bb0f61-bc08-4515-a117-03014d6d389e]

```
```julia id=3ad50dd4-652c-4a41-b27d-02fa5aa4fbde
#Each row below defines a set of section properties. There are 4 rows because there are
4 cross-sections in this example - 8ZS2.25x070, 8ZS2.25x059, 8ZS2.25x070+ 8ZS2.25x059 at
a splice, and 8ZS2.25x059+8ZS2.25x059 at a splice. ↗
```

```
#Ix Iy Ixy J Cw Wn McrLx McrLy
SectionProperties = [
 (9.18,1.28,-2.47,0.00159,15.1, 151.86, 66.33),
 (7.76,1.08,-2.08,0.000954,12.7, 91.48, 40.06),
 (9.18+7.76,1.28+1.08,-(2.47+2.08),0.00159+0.000954, (15.1+12.7)*2, 151.86+91.48,
66.33+40.06),
 (7.76*2,1.08*2,-2.08*2,0.000954*2,12.7*4, 2*91.48, 2*40.06)];
```

```
...
```

*\*The unit warping stress  $W_n$  is multiplied by 4 in the spliced regions because otherwise the AISI bending+torsion interaction equation predicts failure. More work is needed to determine how to consider bimoment in the design of spliced regions.\**

*\* $I_{xy}$  is negative here because the AISI D100 coordinate system has  $y$  pointing up however the PLautBeam coordinate system has  $y$  pointing down.\**

*\*The critical elastic buckling moments  $M_{crLx}$  and  $M_{crLy}$  were calculated with CUFSM. In the future they could be calculated in this notebook (or in an software workflow) using evolving open-source packages like [pyCUFSM](https://github.com/ClearCalcs/pyCUFSM).\**

## ## Purlin cross-section dimensions

Cross-section dimensions for each of the 4 cross-sections in this example are needed for calculating distortional buckling capacity and shear capacity.

```
```julia id=714eff16-3ad4-4b3a-b5cd-7905ebd2b227
```

```
#t is base metal thickness
#ho, b, d, and h are outside purlin depth, flange width, lip length, and web flat height
#θ is lip angle from the horizontal
#CorZ=0 for C, CorZ=1 for Z
#This nomenclature is consistent with AISI S100-16.
```

```
#t, ho, b, d, θ, CorZ, h
CrossSectionDimensions =
[(0.070, 8.0, 2.25, 0.930, 50, 1, 7.560),
 (0.059, 8.0, 2.25, 0.910, 50, 1, 7.582),
 (0.070+0.059, 8.0, 2.25, 0.910, 50, 1, 7.56),
 (0.059*2, 8.0, 2.25, 0.910, 50, 1, 7.582)];
```

```
````
```

## ## Distributed load location

The distributed load,  $q$ , is applied at the center of the top flange. The variables  $a_x$  and  $a_y$  are the  $x$  and  $y$  distances from the shear center to the load application point. The  $x$ -axis is parallel to the roof and the  $y$ -axis is perpendicular to the roof.

The angle of the load  $q$  to the purlin flange varies. For gravity loading  $q$  is always vertical. For an uplift loading,  $q$  is always perpendicular to the purlin top

flange.

![loadlocation.png][nextjournal#file#f248cc25-8652-4bfa-a971-e1f67f45ef9b]

```
```julia id=7055da08-d743-4e2f-b780-1f75b9f78443
#ax ay
LoadLocation = [((2.250-0.070/2)/2,4), ((2.250-0.059/2)/2,4)];
```
```

### ## Purlin material properties

Typical material properties for cold-formed steel are assumed.

```
```julia id=53f7503f-2968-4c12-8881-a21d0fcf4eab
#E v Fy
MaterialProperties = [(29500,0.30, 55)];
```
```

### ## System bracing details

A standing seam roof with a trapezoidal profile is assumed. The roof is attached to the purlins with low fixed clips at a spacing of 24 in. ↗

The distributed rotational stiffness provided to the purlin by the roof is obtained from clip-panel tests described in [Seek and Laughlin (2017)]([https://cfsei.memberclicks.net/assets/docs/research\\_report/RP18-3\\_Determination%20of%20Effective%20Standoff%20in%20SSRS\\_s.pdf](https://cfsei.memberclicks.net/assets/docs/research_report/RP18-3_Determination%20of%20Effective%20Standoff%20in%20SSRS_s.pdf)) Table A2.1. ↗

The distributed translational stiffness provided to the purlin by the roof is inspired by results from gravity open-web joist tests partially braced by a standing seam roof described in [Cronin and Moen (2012)](<https://vtechworks.lib.vt.edu/handle/10919/18711>). ↗

*\*It is assumed that  $k_x$  for gravity loads is twice that of uplift loads because for gravity loads the roof tends to 'hug' the clips.\** ↗

*\*More work is needed to quantify in-situ standing seam roof clip stiffness.\**

*\*The roof diaphragm shear stiffness is assumed to be much higher than the lateral clip stiffness and therefore only the clip stiffnesses affect the purlin deformations in this example.\* \*A springs-in-series model could be constructed using [recent research] (<https://jscholarship.library.jhu.edu/handle/1774.2/62114>) to study the impact of the roof diaphragm on purlin design.\** ↗

![springs.png][nextjournal#file#a2c5af5f-cdf9-4283-b9f5-5f098e99bf7f]

```
```julia id=6ad051e4-0ddd-4445-abcb-3af569cf8ffc
#kx kφ Lm a
#kx has units of kips/in./in., and kφ of kips-in./rad/in.
#Lm is the spacing between bracing that restrains distortional buckling
#a is the web shear stiffener spacing, assumed equal to the span length here since none
are provided
```
```



```
BracingProperties = [(0.100,0.100, 25.0*12, 25.0*12)];
```

```
```
```

The bracing properties above are for the gravity load case. They will be updated later in the example for the uplift case.

With all inputs defined, we can now calculate standing seam roof system capacity.

```
# Roof capacity under gravity loading
```

```
## Deflections
```

When the standing seam roof carries a downward gravity pressure, downward forces are applied to the center of the purlin top flange at the clips as shown in Figure 6 which creates bending and twist deformations. Let's review these deformations for a gravity roof pressure of 10 psf. They are calculated with elastic second order analysis using the [Plaut and Moen (2020)](<https://cloud.aisc.org/SSRC/43PlautandMoen2020SSRC.pdf>) formulation.

```
![gravity.png][nextjournal#file#787987ad-84c0-4f80-a9a9-2e1971fdc760]
```

```
```julia id=9b4778c4-ea8c-47d3-b687-dcc8fb058546
```

```
#Solve for the purlin line deformations
```

```
#10 psf pressure
```

```
Pressure=10/1000/144 #kips/in.^2
```

```
q=Pressure*PurlinSpacing*cos(deg2rad(RoofSlope)) #cosine here for slope
```

```
qx = -q*sin(deg2rad(RoofSlope))
```

```
qy = q*cos(deg2rad(RoofSlope))
```

```
UniformLoad=(qx,qy)
```

```
z, u, v, φ, beamProperties = PlautBeam.solve(MemberDefinitions, SectionProperties, MaterialProperties, LoadLocation, BracingProperties, EndBoundaryConditions, Supports, UniformLoad);
```

```
```
```

```
```julia id=97468c52-9472-4e55-8516-03b60bbf38c1
```

```
plot(z/12,u, legend=false, markershape=:circle)
```

```
ylabel!("u [in.]")
```

```
xlabel!("z [ft.]")
```

```
```
```

```
![result][nextjournal#output#97468c52-9472-4e55-8516-03b60bbf38c1#result]
```

```
```julia id=4defdddb-a71d-4ddb-81f3-3908107d5c5d
```

```
plot(z/12,v, legend=false)
```

```
ylabel!("v [in.]")
```

```
xlabel!("z [ft.]")
```

```
```
```

```
![result][nextjournal#output#4defdddb-a71d-4ddb-81f3-3908107d5c5d#result]
```

```

````julia id=a3149beb-898e-4e54-b486-5f7b14e9385c
plot(z/12,rad2deg.(φ), legend=false)
ylabel!("phi [degrees]")
xlabel!("z [ft.]")
````

```

![result][nextjournal#output#a3149beb-898e-4e54-b486-5f7b14e9385c#result]

Demand moments, shear and torsion

The moments about the cross-section centroidal axes, torsion, bimoment, and shear on the centroidal axes can be calculated from these deformations. [↗](#)

```

````julia id=82ba721a-a638-4fb5-a94b-13ccb96c865e
Mxx = InternalForces.moment(z, beamProperties.dm, -v, beamProperties.E,
beamProperties.Ix);
Myy = InternalForces.moment(z, beamProperties.dm, -u, beamProperties.E,
beamProperties.Iy);
Vyy = InternalForces.shear(z, beamProperties.dm, -v, beamProperties.E,
beamProperties.Ix);
Vxx = InternalForces.shear(z, beamProperties.dm, -u, beamProperties.E,
beamProperties.Iy);
T = InternalForces.torsion(z, beamProperties.dm, φ, beamProperties.E, beamProperties.G,
beamProperties.J, beamProperties.Cw);
B = InternalForces.bimoment(z, beamProperties.dm, φ, beamProperties.E,
beamProperties.Cw);
````

```

Positive moments, shear and torsion follow the nomenclature in the figure below.

![beamaxes.png][nextjournal#file#b29d6bbb-481c-4c64-9a20-666e3a3dbdc0]

```

````julia id=413e4b98-f535-4bc6-9ebd-bd0f2eaa3e50
plot(z/12,Mxx, legend=false)
ylabel!("Mxx [kip-in.]")
xlabel!("z [ft.]")
````

```

![result][nextjournal#output#413e4b98-f535-4bc6-9ebd-bd0f2eaa3e50#result]

```

````julia id=100c501f-160b-4c53-82d4-0535f2764dbc
plot(z/12,Vyy, legend=false)
ylabel!("Vyy [kips]")
xlabel!("z [ft.]")
````

```

![result][nextjournal#output#100c501f-160b-4c53-82d4-0535f2764dbc#result]

```

````julia id=dca85795-b5e7-4767-88af-bf10b1ba5cea
plot(z/12,Myy, legend=false)

```

```
ylabel!("Myy [kip-in.]")
xlabel!("z [ft.]")
```

```

```
![result][nextjournal#output#dca85795-b5e7-4767-88af-bf10b1ba5cea#result]
```

```
```julia id=d657b079-e288-4708-b6dc-87e8586e2a3d
plot(z/12,Vxx, legend=false)
ylabel!("Vxx [kips]")
xlabel!("z [ft.]")
```
```

```
![result][nextjournal#output#d657b079-e288-4708-b6dc-87e8586e2a3d#result]
```

```
```julia id=154ac64c-8079-443f-87c4-9869e7fff710
plot(z/12,T, legend=false)
ylabel!("T [kip-in.]")
xlabel!("z [ft.]")
```
```

```
![result][nextjournal#output#154ac64c-8079-443f-87c4-9869e7fff710#result]
```

```
```julia id=3dd7c895-1bdf-4f79-8b5d-cd7a7f588dcf
plot(z/12,B, legend=false)
ylabel!("B [kip-in.^2]")
xlabel!("z [ft.]")
```
```

```
![result][nextjournal#output#3dd7c895-1bdf-4f79-8b5d-cd7a7f588dcf#result]
```

Purlin strength limit state checks

The expected strength of the purlin line is defined when one of 4 strength limit states are violated along the spans: (1) distortional buckling, (2) bending+torsion interaction, (3) biaxial bending, or (4) bending+shear. The checks are performed with elastic demand shears, moments and torsion considering second order effects and connection stiffness as specified in AISI S100-16 Section C1 "Design for System Stability".

1. The distortional buckling capacity is calculated with AISI S100-16 Eq. F4.1-1, where the critical elastic distortional buckling stress F_{crd} is obtained using AISI S100-16 Appendix 2, Eq. 2.3.3.3-1 assuming the standing seam clips do not provide rotational restraint, i.e., $k_{\phi}=0$ in Eq. 2.3.3.3-1. The distance between discrete restraints that restrain distortional buckling is defined as the span length, i.e., $L_m=25$ ft. in Section 7.8 above. Since M_{nd} is calculate about the x -axis, the demand that it is compared to is M_{xx} when defining failure.
2. The bending+torsion interaction check is defined in AISI S100-24 Eq. H4.2-1:

$$\frac{\overline{M}_x}{M_{ax}} + \frac{\overline{M}_y}{M_{ay}} + \frac{\overline{B}}{B_a} \leq 1.15$$

\$\$

The demand moments $\overline{M}_x = M_{xx}$ and $\overline{M}_y = M_{yy}$ with trends consistent with those in Section 8.2. The expected local buckling strengths are calculated with AISI S100-16 Section F.3.2.1 where $M_{ax} = M_{n\ell x} / \Omega_b$ and $M_{ay} = M_{n\ell y} / \Omega_b$. The critical elastic local buckling moments M_{crx} and M_{cry} are calculated with CUFSM and defined in Section 7.6.

The demand bimoment is \overline{B} (again see Section 8.2) and $B_a = B_n / \Omega_b$ is calculated with AISI S100-24 Eq. H4.1-1:

\$\$

$$B_n = F_y C_w / W_n$$

\$\$

where W_n is the maximum magnitude of cross-section unit warping calculated in CUFSM and defined in Section 7.4 and $\Omega_b = 1.67$.

3. The biaxial bending strength limit state is checked with AISI S100-16 Eq. H1.2-1.

4. The bending+shear strength limit state is evaluated with AISI S100-16 Eq. H2-1.

Other interaction checks could be considered here instead of those listed above. For example, Prof. Seek's recent work on calculating stresses on the cross-section including flexure and torsion and applying the Direct Strength Method are in play.

Global buckling as defined in the Direct Strength Method is considered in the second-order analysis and interaction checks, not with a critical elastic buckling load. So here there is no M_{cre} calculated for gravity loads, or for the uplift load case next.

Purlin line capacity under gravity loading

Failure in the purlin line is calculated by increasing the roof pressure until one of the strength limit states is violated.

```
```julia id=817b1450-4cc6-4c19-abb4-d1272245c1fb
```

```
GravityOrUplift=0 #GravityOrUplift=0 for gravity loading
```

```
eqn, z, strengths, forces, interactions, dc = PurlinDesigner.lineStrength(ASDorLRFD, GravityOrUplift, MemberDefinitions, SectionProperties, CrossSectionDimensions, MaterialProperties, LoadLocation, BracingProperties, RoofSlope, EndBoundaryConditions, Supports)
```

```
FailurePressure=eqn/(PurlinSpacing*cos(deg2rad(RoofSlope)))*1000*144
```

```
println("ASD expected gravity roof capacity = ",round(FailurePressure,digits=1), " psf")
```

```
```julia id=e6941cb3-40b2-4965-a7c8-1244bdc7b074
```

```
plot(z/12,dc.dist, legend=false)
```

```
plot!([0, 102],[1.0, 1.0], linecolor=:red, linewidth=2)
```

```
ylabel!("Distortional buckling demand/capacity ratio")
```

```
xlabel!("z [ft.]")
```

```
ylims!((0,1.41))
```

```
xlims!((0,102))
```

```
```
```

```
![result][nextjournal#output#e6941cb3-40b2-4965-a7c8-1244bdc7b074#result]
```

```
```julia id=df5330c9-b645-4c3e-b1e2-4efe6722db74
plot(z/12,interactions.BTTototal, label="Interaction")
plot!(z/12, interactions.BTMxx, label="ActionMxx")
plot!(z/12, interactions.BTMy, label="ActionMy")
plot!(z/12, interactions.BTB, label="ActionB")
plot!([0, 102],[1.15, 1.15], label="Limit", linecolor=:red, linewidth=2)
ylabel!("Flexure+torsion interaction")
xlabel!("z [ft.]")
ylims!((0,1.41))
xlims!((0,102))
```
```

```
![result][nextjournal#output#df5330c9-b645-4c3e-b1e2-4efe6722db74#result]
```

```
```julia id=e9532bd3-e0d3-40ee-985f-4759118ede93
plot(z/12,interactions.BBTototal, label="Interaction")
plot!(z/12, interactions.BBMxx, label="ActionMxx")
plot!(z/12, interactions.BBMy, label="ActionMy")
plot!([0, 102],[1.0, 1.0], label="Limit", linecolor=:red, linewidth=2)
ylabel!("Biaxial bending")
xlabel!("z [ft.]")
ylims!((0,1.41))
xlims!((0,102))
```
```

```
![result][nextjournal#output#e9532bd3-e0d3-40ee-985f-4759118ede93#result]
```

```
```julia id=b9724a10-0da7-4376-98cc-5a7a40d81a30
plot(z/12,dc.MV, legend=false)
plot!([0, 102],[1.0, 1.0], linecolor=:red, linewidth=2)
ylabel!("Shear+flexure demand/capacity ratio")
xlabel!("z [ft.]")
ylims!((0,1.41))
xlims!((0,102))
```
```

```
![result][nextjournal#output#b9724a10-0da7-4376-98cc-5a7a40d81a30#result]
```

### ## Purlin line capacity trends under gravity loading

The purlin line failure pressure under gravity loading is calculated with varying lateral [↗](#) and rotational bracing stiffness to show its influence on failure pressure.

```
```julia id=948f34af-2a7b-49f9-8d88-a0392110c26e
kx=[0.0:0.02:0.1;0.15:0.05:1.0]
kφ=0.0:0.05:0.1
```

```

eqn=zeros(length(kx),length(kφ))
for i in eachindex(kx)
    for j in eachindex(kφ)

        BracingProperties=[(kx[i],kφ[j],25.0*12, 25.0*12)]

        eqn[i,j], z, strengths, forces, interactions, dc =
PurlinDesigner.lineStrength(ASDorLRFD, GravityOrUplift, MemberDefinitions,
SectionProperties, CrossSectionDimensions, MaterialProperties, LoadLocation,
BracingProperties, RoofSlope, EndBoundaryConditions, Supports)

    end

end

```julia id=9a779903-ad41-4ae6-925b-67f257f2785f
FailurePressure=eqn./((PurlinSpacing.*cos.(deg2rad(RoofSlope))) .*1000 .*144;

```julia id=4004665b-96b8-4b10-860a-7c990460ce7e
plot(kx,FailurePressure[:,1], markershape=:circle, label="kphi=0.0")
plot!(kx,FailurePressure[:,2], markershape=:square, label="kphi=0.05")
plot!(kx,FailurePressure[:,3], markershape=:diamond, label="kphi=0.10")

ylabel!("ASD expected gravity roof capacity [psf]")
xlabel!("kx [kips/in./in.]")

```

```
![[result]][nextjournal#output#4004665b-96b8-4b10-860a-7c990460ce7e#result]
```

Another interesting study is to vary the roof slope and observe its effect on purlin line strength.

```

```julia id=58ce9e06-013e-4755-8a8f-6dde6d4e7564
BracingProperties=[(0.100,0.100,25.0*12, 25.0*12)]

RoofSlope=rad2deg.(atan.(0.0:(0.5/12):(4/12)))

eqn=zeros(length(RoofSlope))
for i in eachindex(RoofSlope)
 eqn[i], z, strengths, forces, interactions, dc =
PurlinDesigner.lineStrength(ASDorLRFD, GravityOrUplift, MemberDefinitions,
SectionProperties, CrossSectionDimensions, MaterialProperties, LoadLocation,
BracingProperties, RoofSlope[i], EndBoundaryConditions, Supports)

end

```

```
````julia id=7b75c2fe-2bb2-4e5d-bc3a-e8cd0ba04492
FailurePressure=eqn./((PurlinSpacing.*cos.(deg2rad.(RoofSlope)))) .*1000 .*144;
````
```

```
````julia id=78fe6013-3e0c-4125-a2f1-2b9b8014bd8c
plot(RoofSlope, FailurePressure, markershape=:circle, legend=false)
```

```
ylabel!("ASD expected gravity roof capacity [psf]")
xlabel!("Roof slope [degrees]")
ylims!((0,25))
````
```

```
![result][nextjournal#output#78fe6013-3e0c-4125-a2f1-2b9b8014bd8c#result]
```

```
Roof capacity under uplift loading
```

```
Deflections
```

When the standing seam roof carries an uplift pressure, clip forces normal to the roof face are applied to the center of the purlin top flange which creates bending and twist deformations that are different than the gravity loading. Let's review these deformations for an uplift roof pressure of -10 psf. [↗](#)

```
![upliftr1.png][nextjournal#file#43faf585-5766-4e9f-82e8-f93766d51a58]
```

```
````julia id=e54fb007-7eef-464a-b606-25acca055d6f
RoofSlope=0.0 #this sets the load perpendicular to the roof for uplift loading
```

```
#reduce kx by half for uplift loading, no hugging
BracingProperties = [(0.100/2,0.100, 25.0*12, 25.0*12)];
```

```
#Solve for the purlin line deformations
#-10 psf pressure load
Pressure=-10/1000/144 #kips/in.^2
```

```
q=Pressure*PurlinSpacing
qx = -q*sin(deg2rad(RoofSlope))
qy = q*cos(deg2rad(RoofSlope))
UniformLoad=(qx,qy)
```

```
z, u, v, φ, beamProperties = PlautBeam.solve(MemberDefinitions, SectionProperties,
MaterialProperties, LoadLocation, BracingProperties, EndBoundaryConditions, Supports,
UniformLoad);
```

```
````julia id=6dfe7c31-eeef4-4eb9-8286-53630c81e044
plot(z/12,u, legend=false)
ylabel!("u [in.]")
xlabel!("z [ft.]")
````
```

```
![result][nextjournal#output#6dfe7c31-eef4-4eb9-8286-53630c81e044#result]
```

```
```julia id=3578f0b5-c87a-4e5e-92a7-b2378c504293
plot(z/12,v, legend=false)
ylabel!("v [in.]")
xlabel!("z [ft.]")
```
```

```
![result][nextjournal#output#3578f0b5-c87a-4e5e-92a7-b2378c504293#result]
```

```
```julia id=c8eb5ab6-c131-4c81-bce9-fbc1044175b4
plot(z/12,rad2deg.(φ), legend=false)
ylabel!("phi [degrees]")
xlabel!("z [ft.]")
```
```

```
![result][nextjournal#output#c8eb5ab6-c131-4c81-bce9-fbc1044175b4#result]
```

Demand moments and torsion

The moments about the cross-section centroidal axes, torsion, bimoment, and shear on the centroidal axes can be calculated from these deformations. [↗](#)

```
```julia id=adb79551-bf74-4431-a53c-af5a076e0037
Mxx = InternalForces.moment(z, beamProperties.dm, -v, beamProperties.E,
beamProperties.Ix);
Myy = InternalForces.moment(z, beamProperties.dm, -u, beamProperties.E,
beamProperties.Iy);
Vyy = InternalForces.shear(z, beamProperties.dm, -v, beamProperties.E,
beamProperties.Ix);
Vxx = InternalForces.shear(z, beamProperties.dm, -u, beamProperties.E,
beamProperties.Iy);
T = InternalForces.torsion(z, beamProperties.dm, φ, beamProperties.E, beamProperties.G,
beamProperties.J, beamProperties.Cw);
B = InternalForces.bimoment(z, beamProperties.dm, φ, beamProperties.E,
beamProperties.Cw);
```
```

```
```julia id=7c4b809f-49a6-4fc5-9a78-9484e4f3fb4c
plot(z/12,Mxx, legend=false)
ylabel!("Mxx [kip-in.]")
xlabel!("z [ft.]")
```
```

```
![result][nextjournal#output#7c4b809f-49a6-4fc5-9a78-9484e4f3fb4c#result]
```

```
```julia id=a3f63bf9-e2eb-4cbd-adce-3f874e10de19
plot(z/12,Vyy, legend=false)
ylabel!("Vyy [kips]")
xlabel!("z [ft.]")
```
```



```
![result][nextjournal#output#a3f63bf9-e2eb-4cbd-adce-3f874e10de19#result]
```

```
```julia id=c992cdf1-21b2-421c-a426-47c8c4a28f58
plot(z/12,Myy, legend=false)
ylabel!("Myy [kip-in.]")
xlabel!("z [ft.]")
```
```

```
![result][nextjournal#output#c992cdf1-21b2-421c-a426-47c8c4a28f58#result]
```

```
```julia id=d3c5fff35-1765-4904-8576-0b0f254aa37d
plot(z/12,Vxx, legend=false)
ylabel!("Vxx [kips]")
xlabel!("z [ft.]")
```
```

```
![result][nextjournal#output#d3c5fff35-1765-4904-8576-0b0f254aa37d#result]
```

```
```julia id=271474be-fb3e-462e-b3e7-7c3458736b4d
plot(z/12,T, legend=false)
ylabel!("T [kip-in.]")
xlabel!("z [ft.]")
```
```

```
![result][nextjournal#output#271474be-fb3e-462e-b3e7-7c3458736b4d#result]
```

```
```julia id=abbf9dea-2083-42cc-a62a-d18b5a0b5094
plot(z/12,B, legend=false)
ylabel!("B [kip-in.^2]")
xlabel!("z [ft.]")
```
```

```
![result][nextjournal#output#abbf9dea-2083-42cc-a62a-d18b5a0b5094#result]
```

Purlin strength limit state checks

In the same way as for gravity pressures (see Section 8.3), failure in the purlin line is assumed to occur at the location where the demand loads first exceed the distortional buckling capacity or violate the bending+torsion interaction check, a biaxial bending check, or a shear+moment interaction check. [↗](#)

Purlin line capacity under uplift loading

Failure in the purlin line is calculated by increasing the roof pressure until a limit state is violated. [↗](#)

```
```julia id=8052f82e-51fc-45bc-8ea4-49743f70c54d
GravityOrUplift=1 #GravityOrUplift=1 for uplift loading
```

```
eqn, z, strengths, forces, interactions, dc = PurlinDesigner.lineStrength(ASDorLRFD, ↗
```

```
GravityOrUplift, MemberDefinitions, SectionProperties, CrossSectionDimensions,
MaterialProperties, LoadLocation, BracingProperties, RoofSlope, EndBoundaryConditions,
Supports)
```

```
FailurePressure=eqn/PurlinSpacing*1000*144
```

```
println("ASD expected uplift roof capacity = ",round(FailurePressure,digits=1), " psf")
```

```
```julia id=aa4fa04c-ee53-4f71-8c61-7655d640081f
plot(z/12,dc.dist, legend=false)
plot!([0, 102],[1.0, 1.0], linecolor=:red, linewidth=2)
ylabel!("Distortional buckling demand/capacity ratio")
xlabel!("z [ft.]")
ylims!((0,1.41))
xlims!((0,102))
```
```

```
![result][nextjournal#output#aa4fa04c-ee53-4f71-8c61-7655d640081f#result]
```

```
```julia id=1b98a875-3f19-477b-bfc5-ab547f08dae1
plot(z/12,interactions.BTTotal, label="Interaction")
plot!(z/12, interactions.BTMxx, label="ActionMxx")
plot!(z/12, interactions.BTMy, label="ActionMy")
plot!(z/12, interactions.BTB, label="ActionB")
plot!([0, 102],[1.15, 1.15], label="Limit", linecolor=:red, linewidth=2)
ylabel!("Flexure+torsion interaction")
xlabel!("z [ft.]")
ylims!((0,1.41))
xlims!((0,102))
```
```

```
![result][nextjournal#output#1b98a875-3f19-477b-bfc5-ab547f08dae1#result]
```

```
```julia id=2877657a-effc-4941-b4fe-3d96077e2f72
plot(z/12,interactions.BBTotal, label="Interaction")
plot!(z/12, interactions.BBMxx, label="ActionMxx")
plot!(z/12, interactions.BBMy, label="ActionMy")
plot!([0, 102],[1.0, 1.0], label="Limit", linecolor=:red, linewidth=2)
ylabel!("Biaxial bending")
xlabel!("z [ft.]")
ylims!((0,1.41))
xlims!((0,102))
```
```

```
![result][nextjournal#output#2877657a-effc-4941-b4fe-3d96077e2f72#result]
```

```
```julia id=235992c6-6872-4634-9088-16c37faf15bb
plot(z/12,dc.MV, legend=false)
plot!([0, 102],[1.0, 1.0], linecolor=:red, linewidth=2)
```

```
ylabel!("Shear+flexure demand/capacity ratio")
xlabel!("z [ft.]")
ylims!((0,1.41))
xlims!((0,102))
```

```

```
![result][nextjournal#output#235992c6-6872-4634-9088-16c37faf15bb#result]
```

## ## Purlin line capacity trends under uplift loading

The purlin line failure pressure under uplift loading is calculated with varying bracing conditions to show what influences the calculated failure pressure. ↗

```
```julia id=aab5a537-14b5-40fa-9fe6-01c756926add
kx=[0.0:0.02:0.1;0.15:0.05:0.3]
kφ=0.0:0.05:0.1
```

```
eqn=zeros(length(kx),length(kφ))
for i in eachindex(kx)
    for j in eachindex(kφ)
```

```
        BracingProperties=[(kx[i],kφ[j],25.0*12, 25.0*12)]
```

```
        eqn[i,j], z, strengths, forces, interactions, dc =
PurlinDesigner.lineStrength(ASDorLRFD, GravityOrUplift, MemberDefinitions,
SectionProperties, CrossSectionDimensions, MaterialProperties, LoadLocation,
BracingProperties, RoofSlope, EndBoundaryConditions, Supports)
        ↗
        ↗
        ↗
```

```
    end
```

```
end
```
```

```
```julia id=ef2873e6-e002-4091-afb3-6e47fc89aa0b
FailurePressure=eqn./PurlinSpacing .*1000 .*144;
```
```

```
```julia id=0b78cd76-5e63-449d-ab16-2f697cd32454
plot(kx,FailurePressure[:,1], markershape=:circle, label="kphi=0.0")
plot!(kx,FailurePressure[:,2], markershape=:square, label="kphi=0.05")
plot!(kx,FailurePressure[:,3], markershape=:diamond, label="kphi=0.10")
```

```
ylabel!("ASD expected uplift roof capacity [psf]")
xlabel!("kx [kips/in./in.]")
ylims!((-22.0, 0.0))
```
```

```
![result][nextjournal#output#0b78cd76-5e63-449d-ab16-2f697cd32454#result]
```

## # Conclusions

This example highlights how the AISI specification, the Direct Strength Method, and open-source software can be used to calculate the strength of a purlin line supporting a standing seam roof in a metal building.

- \* Distortional buckling in the exterior spans is the controlling limit state for a gravity loading. This could be remedied by decreasing the standing seam roof clip spacing.
- \* Bending+torsion interaction at the first interior support is the controlling limit state for an uplift loading. The purlin flanges get worked hard in the splice region as the purlin twists and bends.
- \* Purlin line strength gets big help from small amounts of lateral stiffness  $k_x$ . Rotational stiffness is less important.

## # Ongoing Work

Work continues on the following:

- \* add a local buckling calculator to this workflow
- \* shell finite verification studies of PlautBeam solutions including translational and rotational springs
- \* add pattern loads and point loads
- \* add discrete springs that could be used to model intermediate bracing
- \* make this workflow accessible with an API
- \* increase calculation speed and efficiency in preparation for optimization and machine learning studies
- \* add 3D visualization and a web UI

## # Appendix - verification studies

Verification studies of the AISI10016 module are performed as unit test sets on GitHub, see the /tests folder. Critical elastic local and distortional buckling are verified with CUFSM, and Direct Strength Method calculations are verified with a spreadsheet downloaded from the Hopkins Thin-Walled Structures Group website.

Verification studies of the PlautBeam module include first order analysis deflections and internal forces that were confirmed to match MASTAN2. It was determined that any further second order analysis verification with MASTAN2 did not make sense since it is not very easy to include distributed springs and the second order formulation is for doubly-symmetric I-sections, especially the Lagrangian body-fixed coordinate system terms in the geometric stiffness matrix.

Some verification of the PlautBeam module has been completed with shell finite element analysis in [LS-DYNA](<http://lstc.com/products/ls-dyna>) for the case of a single span Z purlin under gravity load studied in Example 2 of [Plaut and Moen (2020). "Lateral-Torsional Deformations of C-Section and Z-Section Beams with Continuous Bracing."] (<https://cloud.aisc.org/SSRC/43PlautandMoen2020SSRC.pdf>) The first study with  $k_x=k_\phi=0$  predicted consistent  $u^*$ ,  $v^*$ , and  $\phi$  to LS-DYNA under gravity loads.

The second LS-DYNA gravity load second study with  $k_x=k_\phi=0$ ,  $a_x^*=27.826$  mm (1.096 in.), and  $a_y=101.6$  mm (4.0 in.) showed that PlautBeam underpredicted  $u^*$ ,

$\phi$ , and  $\phi$  compared to shell finite element analysis by as much as 70%, compare  $u$  of 2.0 mm to 1.3 mm, and  $\phi = 0.020$  radians to 0.013 radians. This difference is partially because of cross-section deformation that occurs when the load is applied to the flange, and partially because PlautBeam uses a space-fixed coordinate system for its second-order analysis instead of a body-fixed coordinate system. Even though the deformations are underpredicted by PlautBeam, it is expected that the internal moments and torsion calculated from the LS-DYNA deformations will be consistent with PlautBeam because they are dependent upon changes in the deformations, not the absolute magnitudes.

![SSRC2020loading.png][nextjournal#file#8bdf7490-26f3-4ff1-ae80-2a90f0da90ae]

![SSRC2020def.png][nextjournal#file#007a30d3-2c6c-4c11-9fd2-b60f26bc60c6]

A study is also underway that will compare flexural capacity predictions from PurlinDesigner with existing simple span purlin tests supporting a screw fastened roof. This study will be presented at the [Cold-Formed Steel Research Consortium Colloquium] (<https://cfsrc.org/2020/08/06/colloquium-preliminary-program/>) coming up in November 2020.

[nextjournal#file#17b302b6-df36-4c3f-8fd6-95a84810822f]:  
<<https://nextjournal.com/data/QmbG46VTH972g7cFUinfBiXfGrwcB4TjCfL999Vs4PVKyt?filename=spanlayout.png&content-type=image/png>> (Figure 1: 4 span continuous Z-purlin line dimensions and layout)

[nextjournal#file#b0ddfd92-c2ad-4f05-9f45-d136dcca5db9]:  
<<https://nextjournal.com/data/QmNpVCZVsqzMYWk94ey4PnJDxcWXL3KLTojafNVfEY95Ma?filename=RoofCrossSectionr1.png&content-type=image/png>> (Figure 2: Roof cross-sections, one purlin and a roof tributary width are considered)

[nextjournal#file#c8bb0f61-bc08-4515-a117-03014d6d389e]:  
<<https://nextjournal.com/data/QmPrnhA9gZapxeizk9MwVcC6S4uNKeowxk2BAcgp8YxhHS?filename=axes.png&content-type=image/png>> (Figure 3: Cross-section coordinate systems, 1-2 are the principal axes)

[nextjournal#file#f248cc25-8652-4bfa-a971-e1f67f45ef9b]:  
<<https://nextjournal.com/data/QmR96xeWLqooaVzoEBLPWwEPqfYj863rPWZ5V1m4MzyGVq?filename=loadlocation.png&content-type=image/png>> (Figure 4: Load location,  $q$  is always perpendicular to the flange for an uplift loading and vertical for a gravity loading)

[nextjournal#file#a2c5af5f-cdf9-4283-b9f5-5f098e99bf7f]:  
<<https://nextjournal.com/data/QmSC4kdwfn6N4ZYvtgoUQjEnbTSpN8hQP6ngH9zat1TE5s?filename=springs.png&content-type=image/png>> (Figure 5: Springs attached to the top flange,  $k_x$  always acts parallel to the x-axis)

[nextjournal#file#787987ad-84c0-4f80-a9a9-2e1971fdc760]:  
<<https://nextjournal.com/data/QmWkebexb3tM9ynkvL3cF5DELj2RxfMKQtQ3kktVprzmYA?filename=gravity.png&content-type=image/png>> (Figure 6: Gravity load structural analysis,  $q$  is vertical, z-axis is into the page)

[nextjournal#output#97468c52-9472-4e55-8516-03b60bbf38c1#result]:  
<<https://nextjournal.com/data/Qmaxcfmi3nm6TkGoCe4CMkRDDakbxhjQtu3mCAAFdtSdNy?content->

type=image/svg%2Bxml>

[nextjournal#output#4defdddb-a71d-4ddb-81f3-3908107d5c5d#result]:  
<<https://nextjournal.com/data/Qmc2QC9cewNog4hFZhL41nmi1zqNV24L4JH9bwFNx3pzTS?content-type=image/svg%2Bxml>> 

[nextjournal#output#a3149beb-898e-4e54-b486-5f7b14e9385c#result]:  
<<https://nextjournal.com/data/QmPgJsBkthATcVgcx9bPqPACeWnL1xYG17srsWPwSCvS9?content-type=image/svg%2Bxml>> 

[nextjournal#file#b29d6bbb-481c-4c64-9a20-666e3a3dbdc0]:  
<<https://nextjournal.com/data/QmVVpfNg8whFnYyCVTR7VpwASwywgFgxjH1hojmAc6kc8P?filename=beamaxes.png&content-type=image/png>> (Figure 7: Sign convention for internal forces and moments, see cut in the beam) 

[nextjournal#output#413e4b98-f535-4bc6-9ebd-bd0f2eaa3e50#result]:  
<<https://nextjournal.com/data/QmUXm5g36uxwKwHgVbiCmGjVyuvvcjHgwFXLoB9gQw3Fb3D?content-type=image/svg%2Bxml>> 

[nextjournal#output#100c501f-160b-4c53-82d4-0535f2764dbc#result]:  
<<https://nextjournal.com/data/QmeB94TmeP3BYt8CbXGqxZ2mjJf4uLU7iWLwfX3Anz1Pyx?content-type=image/svg%2Bxml>> 

[nextjournal#output#dca85795-b5e7-4767-88af-bf10b1ba5cea#result]:  
<<https://nextjournal.com/data/QmSe5zXMkm4JNcRRqPXV32VYwLDqgyeRZVhTL73iCV9zJo?content-type=image/svg%2Bxml>> 

[nextjournal#output#d657b079-e288-4708-b6dc-87e8586e2a3d#result]:  
<<https://nextjournal.com/data/QmVXNPQwKJRZf5FuNV1pE14V3ysGZzQCJLvbNXdYgvL3wo?content-type=image/svg%2Bxml>> 

[nextjournal#output#154ac64c-8079-443f-87c4-9869e7fff710#result]:  
<<https://nextjournal.com/data/QmRJVD5xjbvTXaXoEd339oWy6su2J2jtuynvotvsJipJ?content-type=image/svg%2Bxml>> 

[nextjournal#output#3dd7c895-1bdf-4f79-8b5d-cd7a7f588dcf#result]:  
<<https://nextjournal.com/data/QmUCcLfgLzhQhu4x6jaR6XB3r4YC5EVATsKf3E22isB4ZU?content-type=image/svg%2Bxml>> 

[nextjournal#output#e6941cb3-40b2-4965-a7c8-1244bdc7b074#result]:  
<<https://nextjournal.com/data/QmUdQN9upEDPs9bnQfRyqvbN4QhV2w25epneCzeWc2Xz4A?content-type=image/svg%2Bxml>> 

[nextjournal#output#df5330c9-b645-4c3e-b1e2-4efe6722db74#result]:  
<<https://nextjournal.com/data/QmZnm3XEc6F2Je5WwyLvA4Ey6viTEqMQW3mxcdkW8qA7Wq?content-type=image/svg%2Bxml>> 

[nextjournal#output#e9532bd3-e0d3-40ee-985f-4759118ede93#result]:  
<<https://nextjournal.com/data/QmZ7XiUuR3wfkKy88EhBvLFmgEDbA2fzPDpY93r5gumM1q?content-type=image/svg%2Bxml>> 

[nextjournal#output#b9724a10-0da7-4376-98cc-5a7a40d81a30#result]:  
<<https://nextjournal.com/data/QmfCnAiwjEvKcxzhZhtms7j618aU3tjs7b2u9No1eDFB?content-type=image/svg%2Bxml>> 

[nextjournal#output#4004665b-96b8-4b10-860a-7c990460ce7e#result]:  
<<https://nextjournal.com/data/QmS4rEyHg7hqgX9YUFBcvYvyTcaAy2hqViP3AMjTVqMP3P?content-type=image/svg%2Bxml>> 

[nextjournal#output#78fe6013-3e0c-4125-a2f1-2b9b8014bd8c#result]:  
<<https://nextjournal.com/data/QmQG94L2RUQYUvBS7xovbe8NFjJSYap6aWbtym8g3AnrCP?content-type=image/svg%2Bxml>> 

[nextjournal#file#43faf585-5766-4e9f-82e8-f93766d51a58]:  
<<https://nextjournal.com/data/Qmafof7uDyNeNHZxvuppJzPq8WuM68bCGGR5vUuQCWFvME?filename=upliftr1.png&content-type=image/png>> (Figure 7: Uplift structural analysis,  $q$  is perpendicular to the flange) 

[nextjournal#output#6dfe7c31-eef4-4eb9-8286-53630c81e044#result]:  
<<https://nextjournal.com/data/QmPwmqehwAA7Pdc85hE43NjP8G2s1LKFrtsRtcA3xZ6hws?content-type=image/svg%2Bxml>> 

[nextjournal#output#3578f0b5-c87a-4e5e-92a7-b2378c504293#result]:  
<<https://nextjournal.com/data/QmfXPL4S3Uyp7azQyWoFuwsHXXuny7d6dZVv4dwNvEiVpM?content-type=image/svg%2Bxml>> 

[nextjournal#output#c8eb5ab6-c131-4c81-bce9-fbc1044175b4#result]:  
<<https://nextjournal.com/data/QmR5Z7AKet6VLkoHmw8reSRJpJSv8d8RbBRXVyCcmvfnow?content-type=image/svg%2Bxml>> 

[nextjournal#output#7c4b809f-49a6-4fc5-9a78-9484e4f3fb4c#result]:  
<<https://nextjournal.com/data/QmPGXjbeAzMredAMUzLZ2mhFKvjvQQhTAZt1g9wnCUCELc?content-type=image/svg%2Bxml>> 

[nextjournal#output#a3f63bf9-e2eb-4cbd-adce-3f874e10de19#result]:  
<<https://nextjournal.com/data/QmZXJo2bo26Hr34daWN9z4DrRq7cBJjoqNYRwigdp57rKt?content-type=image/svg%2Bxml>> 

[nextjournal#output#c992cdf1-21b2-421c-a426-47c8c4a28f58#result]:  
<<https://nextjournal.com/data/Qmee8AiGstN6DvBTEUiKqfnvyotVM4r23LyCEhSwkJn1Z?content-type=image/svg%2Bxml>> 

[nextjournal#output#d3c5ff35-1765-4904-8576-0b0f254aa37d#result]:  
<<https://nextjournal.com/data/Qmbm6Ta9trmB8aiVJcqLGM1cYnup4dzomCZ8SyRgTyPD5L?content-type=image/svg%2Bxml>> 

[nextjournal#output#271474be-fb3e-462e-b3e7-7c3458736b4d#result]:  
<<https://nextjournal.com/data/Qmf3WW9A87tNeF2v3KqgJ2HxbiYNutUqa8Q46WBdTs834w?content-type=image/svg%2Bxml>> 

[nextjournal#output#abbf9dea-2083-42cc-a62a-d18b5a0b5094#result]:  
<<https://nextjournal.com/data/QmTJX6MGqx6bMjTZswN7bNtNJ22sgEnx5WbdrGtvireAQ?content-type=image/svg%2Bxml>> 

```
type=image/svg%2Bxml>
```

```
[nextjournal#output#aa4fa04c-ee53-4f71-8c61-7655d640081f#result]:
<https://nextjournal.com/data/QmRGnuovwNry2akdJLY2jAgfvcq91hbF3RQRcURNtha5Ap?content-
type=image/svg%2Bxml> ↗
```

```
[nextjournal#output#1b98a875-3f19-477b-bfc5-ab547f08dae1#result]:
<https://nextjournal.com/data/QmVacvqpfBxtgwt7kxzEd3QQEyV5MqEWeS2URYLWYF5tYX?content-
type=image/svg%2Bxml> ↗
```

```
[nextjournal#output#2877657a-efc-4941-b4fe-3d96077e2f72#result]:
<https://nextjournal.com/data/QmSnnshNd1LmQCA924mH8EzzZnfdAaPPz9LtoecxmxqH2?content-
type=image/svg%2Bxml> ↗
```

```
[nextjournal#output#235992c6-6872-4634-9088-16c37faf15bb#result]:
<https://nextjournal.com/data/QmPnZTMUDaCnebUZJTBHQrXBm2LvbnjYAhnl5hrLwBaFbC?content-
type=image/svg%2Bxml> ↗
```

```
[nextjournal#output#0b78cd76-5e63-449d-ab16-2f697cd32454#result]:
<https://nextjournal.com/data/QmT1q8mr1NqAy2YoQFXkffJTewyP2RxtfzwbJWffGBJHAv?content-
type=image/svg%2Bxml> ↗
```

```
[nextjournal#file#8bdf7490-26f3-4ff1-ae80-2a90f0da90ae]:
<https://nextjournal.com/data/QmXikNxoqkxtFinU2g36Lrx9t63dYjXxnBtmEjqgUVVK3A?
filename=SSRC2020loading.png&content-type=image/png> (Figure 8: Gravity uniform load at
shear center of purlin, Example 2 Plaut and Moen \ \(2020\\).) ↗
```

```
[nextjournal#file#007a30d3-2c6c-4c11-9fd2-b60f26bc60c6]:
<https://nextjournal.com/data/QmdBXQZoKvmfM9gRYUVFD5HdaP7N3JdsN6hvgXMV95FqTc?
filename=SSRC2020def.png&content-type=image/png> (Figure 9: Deformed shape from uniform
gravity, load at shear center, no springs) ↗
```

```
<details id="com.nextjournal.article">
<summary>This notebook was exported from https://nextjournal.com/a/
LXdpsavN92epHsVGR9tfy?change-id=CmdJyGskBRg7FsntBBUk2m</summary> ↗
```

```
```edn nextjournal-metadata
```

```
{:article
{:settings {:numbered? true},
:nodes
{"007a30d3-2c6c-4c11-9fd2-b60f26bc60c6"
{:id "007a30d3-2c6c-4c11-9fd2-b60f26bc60c6", :kind "file"},
"0b78cd76-5e63-449d-ab16-2f697cd32454"
{:compute-ref #uuid "adda22ba-19e9-4980-bae6-c60bf5a37045",
:exec-duration 1789,
:id "0b78cd76-5e63-449d-ab16-2f697cd32454",
:kind "code",
:output-log-lines {}},
:runtime [[:runtime "c053cbfa-1fe0-440c-9da9-36d72eb0a7bc"]]},
"100c501f-160b-4c53-82d4-0535f2764dbc"
```



```
{:compute-ref #uuid "41c02695-fbbd-4955-91fe-91ad4f9f1ec7",
 :exec-duration 462,
 :id "100c501f-160b-4c53-82d4-0535f2764dbc",
 :kind "code",
 :output-log-lines {},
 :runtime [:runtime "c053cbfa-1fe0-440c-9da9-36d72eb0a7bc"]]},
"154ac64c-8079-443f-87c4-9869e7fff710"
{:compute-ref #uuid "fa08e2b9-d388-4027-897f-9cc84c1974f9",
 :exec-duration 438,
 :id "154ac64c-8079-443f-87c4-9869e7fff710",
 :kind "code",
 :output-log-lines {},
 :runtime [:runtime "c053cbfa-1fe0-440c-9da9-36d72eb0a7bc"]]},
"17b302b6-df36-4c3f-8fd6-95a84810822f"
{:id "17b302b6-df36-4c3f-8fd6-95a84810822f", :kind "file"},
"1b98a875-3f19-477b-bfc5-ab547f08dae1"
{:compute-ref #uuid "b710af73-4888-46f9-8379-8b6424900c6c",
 :exec-duration 429,
 :id "1b98a875-3f19-477b-bfc5-ab547f08dae1",
 :kind "code",
 :output-log-lines {},
 :runtime [:runtime "c053cbfa-1fe0-440c-9da9-36d72eb0a7bc"]]},
"1cf90000-29cd-4e73-9fd0-c5866ebe44d8"
{:compute-ref #uuid "fbfb805a-a4c1-4e35-8b70-535564f47957",
 :exec-duration 194,
 :id "1cf90000-29cd-4e73-9fd0-c5866ebe44d8",
 :kind "code",
 :output-log-lines {},
 :runtime [:runtime "c053cbfa-1fe0-440c-9da9-36d72eb0a7bc"]]},
"235992c6-6872-4634-9088-16c37faf15bb"
{:compute-ref #uuid "f990b16e-035d-4056-8b6c-e0234f0d1c81",
 :exec-duration 504,
 :id "235992c6-6872-4634-9088-16c37faf15bb",
 :kind "code",
 :output-log-lines {},
 :runtime [:runtime "c053cbfa-1fe0-440c-9da9-36d72eb0a7bc"]]},
"271474be-fb3e-462e-b3e7-7c3458736b4d"
{:compute-ref #uuid "2c4126e2-5408-4609-a50d-d19767ba6fa4",
 :exec-duration 458,
 :id "271474be-fb3e-462e-b3e7-7c3458736b4d",
 :kind "code",
 :output-log-lines {},
 :runtime [:runtime "c053cbfa-1fe0-440c-9da9-36d72eb0a7bc"]]},
"2877657a-effc-4941-b4fe-3d96077e2f72"
{:compute-ref #uuid "efc0e4f8-a3eb-4132-8bbc-839393bcdbac",
 :exec-duration 458,
 :id "2877657a-effc-4941-b4fe-3d96077e2f72",
 :kind "code",
 :output-log-lines {},
 :runtime [:runtime "c053cbfa-1fe0-440c-9da9-36d72eb0a7bc"]]},
"29863b0f-4b40-4fea-8b88-b63c8924f2c1"
```

```
{:compute-ref #uuid "127dc72e-bd53-4d6e-8530-8e4fc49314a5",
 :exec-duration 324096,
 :id "29863b0f-4b40-4fea-8b88-b63c8924f2c1",
 :kind "code",
 :output-log-lines {},
 :runtime [:runtime "c053cbfa-1fe0-440c-9da9-36d72eb0a7bc"]]},
"3578f0b5-c87a-4e5e-92a7-b2378c504293"
{:compute-ref #uuid "c8560a2e-a72d-480c-8511-d68aeba1b5bb",
 :exec-duration 416,
 :id "3578f0b5-c87a-4e5e-92a7-b2378c504293",
 :kind "code",
 :output-log-lines {},
 :runtime [:runtime "c053cbfa-1fe0-440c-9da9-36d72eb0a7bc"]]},
"3ad50dd4-652c-4a41-b27d-02fa5aa4fbde"
{:compute-ref #uuid "9a3de665-b63e-4626-9f32-647a95bbe47f",
 :exec-duration 272,
 :id "3ad50dd4-652c-4a41-b27d-02fa5aa4fbde",
 :kind "code",
 :output-log-lines {},
 :runtime [:runtime "c053cbfa-1fe0-440c-9da9-36d72eb0a7bc"]]},
"3dd7c895-1bdf-4f79-8b5d-cd7a7f588dcf"
{:compute-ref #uuid "5de9ae7f-d348-4ce0-a480-1d42b235d0b4",
 :exec-duration 518,
 :id "3dd7c895-1bdf-4f79-8b5d-cd7a7f588dcf",
 :kind "code",
 :output-log-lines {},
 :runtime [:runtime "c053cbfa-1fe0-440c-9da9-36d72eb0a7bc"]]},
"4004665b-96b8-4b10-860a-7c990460ce7e"
{:compute-ref #uuid "fabb55c1-acaa-410a-a8f2-500c98ac1835",
 :exec-duration 673,
 :id "4004665b-96b8-4b10-860a-7c990460ce7e",
 :kind "code",
 :output-log-lines {},
 :runtime [:runtime "c053cbfa-1fe0-440c-9da9-36d72eb0a7bc"]]},
"413e4b98-f535-4bc6-9ebd-bd0f2eaa3e50"
{:compute-ref #uuid "f1c6c2c2-82bb-47e8-91ac-7ac2a59d6312",
 :exec-duration 426,
 :id "413e4b98-f535-4bc6-9ebd-bd0f2eaa3e50",
 :kind "code",
 :output-log-lines {},
 :runtime [:runtime "c053cbfa-1fe0-440c-9da9-36d72eb0a7bc"]]},
"43a0861c-d555-4abd-be66-eed1801292fd"
{:compute-ref #uuid "4978566d-c8c0-4eab-a273-f9aadd32600",
 :exec-duration 340,
 :id "43a0861c-d555-4abd-be66-eed1801292fd",
 :kind "code",
 :output-log-lines {},
 :runtime [:runtime "c053cbfa-1fe0-440c-9da9-36d72eb0a7bc"]]},
"43faf585-5766-4e9f-82e8-f93766d51a58"
{:id "43faf585-5766-4e9f-82e8-f93766d51a58", :kind "file"},
"4defdddb-a71d-4ddb-81f3-3908107d5c5d"
```

```
{:compute-ref #uuid "52ae8fb3-4689-4e84-ab35-4b358ef2d2e2",
 :exec-duration 679,
 :id "4defdddb-a71d-4ddb-81f3-3908107d5c5d",
 :kind "code",
 :output-log-lines {},
 :runtime [:runtime "c053cbfa-1fe0-440c-9da9-36d72eb0a7bc"]]},
"53f7503f-2968-4c12-8881-a21d0fcf4eab"
{:compute-ref #uuid "b0043f8a-742a-473f-bd20-5553627ab14e",
 :exec-duration 171,
 :id "53f7503f-2968-4c12-8881-a21d0fcf4eab",
 :kind "code",
 :output-log-lines {},
 :refs (),
 :runtime [:runtime "c053cbfa-1fe0-440c-9da9-36d72eb0a7bc"]]},
"58ce9e06-013e-4755-8a8f-6dde6d4e7564"
{:compute-ref #uuid "7acdbaf8-5530-4014-bb66-614e3a611868",
 :exec-duration 223266,
 :id "58ce9e06-013e-4755-8a8f-6dde6d4e7564",
 :kind "code",
 :output-log-lines {},
 :runtime [:runtime "c053cbfa-1fe0-440c-9da9-36d72eb0a7bc"]]},
"6ad051e4-0ddd-4445-abcb-3af569cf8ffc"
{:compute-ref #uuid "246a84f2-9483-4bd6-a784-18417d87df6c",
 :exec-duration 150,
 :id "6ad051e4-0ddd-4445-abcb-3af569cf8ffc",
 :kind "code",
 :output-log-lines {},
 :refs (),
 :runtime [:runtime "c053cbfa-1fe0-440c-9da9-36d72eb0a7bc"]]},
"6dfe7c31-eef4-4eb9-8286-53630c81e044"
{:compute-ref #uuid "37826dc0-1903-47bc-9115-502f6dece307",
 :exec-duration 434,
 :id "6dfe7c31-eef4-4eb9-8286-53630c81e044",
 :kind "code",
 :output-log-lines {},
 :runtime [:runtime "c053cbfa-1fe0-440c-9da9-36d72eb0a7bc"]]},
"7055da08-d743-4e2f-b780-1f75b9f78443"
{:compute-ref #uuid "1a80f10c-764f-4eaf-8e68-bb4563937867",
 :exec-duration 161,
 :id "7055da08-d743-4e2f-b780-1f75b9f78443",
 :kind "code",
 :output-log-lines {},
 :runtime [:runtime "c053cbfa-1fe0-440c-9da9-36d72eb0a7bc"]]},
"714eff16-3ad4-4b3a-b5cd-7905ebd2b227"
{:compute-ref #uuid "123eb249-1554-4f8f-88ef-b89f78a078da",
 :exec-duration 190,
 :id "714eff16-3ad4-4b3a-b5cd-7905ebd2b227",
 :kind "code",
 :output-log-lines {},
 :runtime [:runtime "c053cbfa-1fe0-440c-9da9-36d72eb0a7bc"]]},
"787987ad-84c0-4f80-a9a9-2e1971fdc760"
```

```
{:id "787987ad-84c0-4f80-a9a9-2e1971fdc760", :kind "file"},
"78fe6013-3e0c-4125-a2f1-2b9b8014bd8c"
{:compute-ref #uuid "01570696-0bca-4d84-8a2c-6c909f3d1e4e",
 :exec-duration 1710,
 :id "78fe6013-3e0c-4125-a2f1-2b9b8014bd8c",
 :kind "code",
 :output-log-lines {},
 :runtime [:runtime "c053cbfa-1fe0-440c-9da9-36d72eb0a7bc"]]},
"7b75c2fe-2bb2-4e5d-bc3a-e8cd0ba04492"
{:compute-ref #uuid "8bdb8899-a735-4c87-916e-e0a075158b9f",
 :exec-duration 343,
 :id "7b75c2fe-2bb2-4e5d-bc3a-e8cd0ba04492",
 :kind "code",
 :output-log-lines {},
 :runtime [:runtime "c053cbfa-1fe0-440c-9da9-36d72eb0a7bc"]]},
"7c4b809f-49a6-4fc5-9a78-9484e4f3fb4c"
{:compute-ref #uuid "79001f33-a98b-48be-aa56-2f33491ef51a",
 :exec-duration 536,
 :id "7c4b809f-49a6-4fc5-9a78-9484e4f3fb4c",
 :kind "code",
 :output-log-lines {},
 :runtime [:runtime "c053cbfa-1fe0-440c-9da9-36d72eb0a7bc"]]},
"8044fd0f-2259-4f38-86c4-8db5619d9499"
{:compute-ref #uuid "b4274d1d-379a-4f00-b5c4-4bdb1e8cc01f",
 :exec-duration 113348,
 :id "8044fd0f-2259-4f38-86c4-8db5619d9499",
 :kind "code",
 :output-log-lines {},
 :runtime [:runtime "c053cbfa-1fe0-440c-9da9-36d72eb0a7bc"]]},
"8052f82e-51fc-45bc-8ea4-49743f70c54d"
{:compute-ref #uuid "4104df8a-6e4a-469f-b981-9d2fdd56f8e2",
 :exec-duration 25737,
 :id "8052f82e-51fc-45bc-8ea4-49743f70c54d",
 :kind "code",
 :output-log-lines {:stdout 2},
 :runtime [:runtime "c053cbfa-1fe0-440c-9da9-36d72eb0a7bc"]]},
"817b1450-4cc6-4c19-abb4-d1272245c1fb"
{:compute-ref #uuid "390cd029-d165-4856-b752-3bfa33caafeb",
 :exec-duration 31028,
 :id "817b1450-4cc6-4c19-abb4-d1272245c1fb",
 :kind "code",
 :output-log-lines {:stdout 2},
 :runtime [:runtime "c053cbfa-1fe0-440c-9da9-36d72eb0a7bc"]]},
"82ba721a-a638-4fb5-a94b-13ccb96c865e"
{:compute-ref #uuid "e90ab451-8a3b-439e-978b-e4f1125d766c",
 :exec-duration 2031,
 :id "82ba721a-a638-4fb5-a94b-13ccb96c865e",
 :kind "code",
 :output-log-lines {},
 :runtime [:runtime "c053cbfa-1fe0-440c-9da9-36d72eb0a7bc"]]},
"8bdf7490-26f3-4ff1-ae80-2a90f0da90ae"
```

```
{:id "8bdf7490-26f3-4ff1-ae80-2a90f0da90ae", :kind "file"},
"948f34af-2a7b-49f9-8d88-a0392110c26e"
{:compute-ref #uuid "86dcd3c5-f354-4773-a180-e26619f09091",
 :exec-duration 1512205,
 :id "948f34af-2a7b-49f9-8d88-a0392110c26e",
 :kind "code",
 :output-log-lines {},
 :runtime [[:runtime "c053cbfa-1fe0-440c-9da9-36d72eb0a7bc"]]},
"97468c52-9472-4e55-8516-03b60bbf38c1"
{:compute-ref #uuid "a1333632-a98e-4e51-9dd4-4f5d18dd3d43",
 :exec-duration 32057,
 :id "97468c52-9472-4e55-8516-03b60bbf38c1",
 :kind "code",
 :output-log-lines {},
 :runtime [[:runtime "c053cbfa-1fe0-440c-9da9-36d72eb0a7bc"]]},
"9a779903-ad41-4ae6-925b-67f257f2785f"
{:compute-ref #uuid "26ae4660-be27-447f-bfbe-ecbb6e04d287",
 :exec-duration 421,
 :id "9a779903-ad41-4ae6-925b-67f257f2785f",
 :kind "code",
 :output-log-lines {},
 :runtime [[:runtime "c053cbfa-1fe0-440c-9da9-36d72eb0a7bc"]]},
"9b4778c4-ea8c-47d3-b687-dcc8fb058546"
{:compute-ref #uuid "39f6a6c6-2929-4770-b613-420b196e5e8d",
 :exec-duration 24309,
 :id "9b4778c4-ea8c-47d3-b687-dcc8fb058546",
 :kind "code",
 :output-log-lines {},
 :runtime [[:runtime "c053cbfa-1fe0-440c-9da9-36d72eb0a7bc"]]},
"a2c5af5f-cdf9-4283-b9f5-5f098e99bf7f"
{:id "a2c5af5f-cdf9-4283-b9f5-5f098e99bf7f", :kind "file"},
"a3149beb-898e-4e54-b486-5f7b14e9385c"
{:compute-ref #uuid "736ec3b2-6bbd-470b-8b6c-2174ad88395e",
 :exec-duration 593,
 :id "a3149beb-898e-4e54-b486-5f7b14e9385c",
 :kind "code",
 :output-log-lines {},
 :runtime [[:runtime "c053cbfa-1fe0-440c-9da9-36d72eb0a7bc"]],
 :stdout-collapsed? false},
"a3f63bf9-e2eb-4cbd-adce-3f874e10de19"
{:compute-ref #uuid "2a1fcea8-204b-4cf2-97f0-07d76b77237c",
 :exec-duration 450,
 :id "a3f63bf9-e2eb-4cbd-adce-3f874e10de19",
 :kind "code",
 :output-log-lines {},
 :runtime [[:runtime "c053cbfa-1fe0-440c-9da9-36d72eb0a7bc"]]},
"aa4fa04c-ee53-4f71-8c61-7655d640081f"
{:compute-ref #uuid "6046a0ac-985b-45d4-b27d-8e887e3ced22",
 :exec-duration 471,
 :id "aa4fa04c-ee53-4f71-8c61-7655d640081f",
 :kind "code",
```

```

:output-log-lines {},
:runtime [:runtime "c053cbfa-1fe0-440c-9da9-36d72eb0a7bc"]}],
"aab5a537-14b5-40fa-9fe6-01c756926add"
{:compute-ref #uuid "83300d32-0076-4f4c-ac89-218a2bba5187",
:exec-duration 758491,
:id "aab5a537-14b5-40fa-9fe6-01c756926add",
:kind "code",
:output-log-lines {},
:runtime [:runtime "c053cbfa-1fe0-440c-9da9-36d72eb0a7bc"]}],
"abbf9dea-2083-42cc-a62a-d18b5a0b5094"
{:compute-ref #uuid "21a4b994-cb18-401a-8a88-552e0795b865",
:exec-duration 373,
:id "abbf9dea-2083-42cc-a62a-d18b5a0b5094",
:kind "code",
:output-log-lines {},
:runtime [:runtime "c053cbfa-1fe0-440c-9da9-36d72eb0a7bc"]}],
"adb79551-bf74-4431-a53c-af5a076e0037"
{:compute-ref #uuid "27629245-2d3c-49e9-934c-6831d7400f60",
:exec-duration 160,
:id "adb79551-bf74-4431-a53c-af5a076e0037",
:kind "code",
:output-log-lines {},
:runtime [:runtime "c053cbfa-1fe0-440c-9da9-36d72eb0a7bc"]}],
"b0ddfd92-c2ad-4f05-9f45-d136dcca5db9"
{:id "b0ddfd92-c2ad-4f05-9f45-d136dcca5db9", :kind "file"},
"b29d6bbb-481c-4c64-9a20-666e3a3dbdc0"
{:id "b29d6bbb-481c-4c64-9a20-666e3a3dbdc0", :kind "file"},
"b9724a10-0da7-4376-98cc-5a7a40d81a30"
{:compute-ref #uuid "f285ccab-a2b6-469b-b48d-89bd6b5fcc57",
:exec-duration 442,
:id "b9724a10-0da7-4376-98cc-5a7a40d81a30",
:kind "code",
:output-log-lines {},
:runtime [:runtime "c053cbfa-1fe0-440c-9da9-36d72eb0a7bc"]}],
"c053cbfa-1fe0-440c-9da9-36d72eb0a7bc"
{:environment
[:environment
{:article/nextjournal.id
#uuid "5b460d39-8c57-43a6-8b13-e217642b0146",
:change/nextjournal.id
#uuid "5f0bd3e3-9a65-4c13-b714-ec3b8370eb8a",
:node/id "39e3f06d-60bf-4003-ae1a-62e835085aef"}]],
:environment? false,
:id "c053cbfa-1fe0-440c-9da9-36d72eb0a7bc",
:kind "runtime",
:language "julia",
:name "",
:resources {:machine-type "n1-standard-4"},
:type :nextjournal,
:runtime/mounts []}],
"c8bb0f61-bc08-4515-a117-03014d6d389e"

```

```
{:id "c8bb0f61-bc08-4515-a117-03014d6d389e", :kind "file"},
"c8eb5ab6-c131-4c81-bce9-fbc1044175b4"
{:compute-ref #uuid "7f659514-68ed-4a90-9b4c-cae82174b915",
 :exec-duration 395,
 :id "c8eb5ab6-c131-4c81-bce9-fbc1044175b4",
 :kind "code",
 :output-log-lines {},
 :runtime [:runtime "c053cbfa-1fe0-440c-9da9-36d72eb0a7bc"]]},
"c992cdf1-21b2-421c-a426-47c8c4a28f58"
{:compute-ref #uuid "bef6b7c5-a6dd-42c3-a188-0e7899c4cc5b",
 :exec-duration 436,
 :id "c992cdf1-21b2-421c-a426-47c8c4a28f58",
 :kind "code",
 :output-log-lines {},
 :runtime [:runtime "c053cbfa-1fe0-440c-9da9-36d72eb0a7bc"]]},
"ce18a234-afba-432b-a008-04c05c692318"
{:compute-ref #uuid "bfc5f064-a122-469c-a0e6-37503dfb19ca",
 :exec-duration 208,
 :id "ce18a234-afba-432b-a008-04c05c692318",
 :kind "code",
 :output-log-lines {},
 :runtime [:runtime "c053cbfa-1fe0-440c-9da9-36d72eb0a7bc"]]},
"ce800e8c-2b9b-4d38-982a-655693dd0a51"
{:compute-ref #uuid "3e63a2fa-a034-4d9b-8f60-332ae5a5b5bd",
 :exec-duration 229,
 :id "ce800e8c-2b9b-4d38-982a-655693dd0a51",
 :kind "code",
 :output-log-lines {},
 :runtime [:runtime "c053cbfa-1fe0-440c-9da9-36d72eb0a7bc"]]},
"d3c5ff35-1765-4904-8576-0b0f254aa37d"
{:compute-ref #uuid "9699238e-c968-4713-b736-281f36f907fb",
 :exec-duration 476,
 :id "d3c5ff35-1765-4904-8576-0b0f254aa37d",
 :kind "code",
 :output-log-lines {},
 :runtime [:runtime "c053cbfa-1fe0-440c-9da9-36d72eb0a7bc"]]},
"d657b079-e288-4708-b6dc-87e8586e2a3d"
{:compute-ref #uuid "f09318b6-a91b-4f43-b5d5-3e92e993c210",
 :exec-duration 464,
 :id "d657b079-e288-4708-b6dc-87e8586e2a3d",
 :kind "code",
 :output-log-lines {},
 :runtime [:runtime "c053cbfa-1fe0-440c-9da9-36d72eb0a7bc"]]},
"dca85795-b5e7-4767-88af-bf10b1ba5cea"
{:compute-ref #uuid "842310fd-71ba-46c0-b4d5-7098af8d2c9c",
 :exec-duration 449,
 :id "dca85795-b5e7-4767-88af-bf10b1ba5cea",
 :kind "code",
 :output-log-lines {},
 :runtime [:runtime "c053cbfa-1fe0-440c-9da9-36d72eb0a7bc"]]},
"df5330c9-b645-4c3e-b1e2-4efe6722db74"
```

```
{:compute-ref #uuid "ddd88241-416b-4cab-8a9f-57bab48213ef",
 :exec-duration 1224,
 :id "df5330c9-b645-4c3e-b1e2-4efe6722db74",
 :kind "code",
 :output-log-lines {},
 :runtime [:runtime "c053cbfa-1fe0-440c-9da9-36d72eb0a7bc"]}},
"e0abdd6b-49c6-4932-b99c-a0bbf6ad8b94"
{:compute-ref #uuid "e70e1181-a1d2-4ff6-9298-cff5ac792a1d",
 :exec-duration 227,
 :id "e0abdd6b-49c6-4932-b99c-a0bbf6ad8b94",
 :kind "code",
 :output-log-lines {},
 :runtime [:runtime "c053cbfa-1fe0-440c-9da9-36d72eb0a7bc"]}},
"e54fb007-7eef-464a-b606-25acca055d6f"
{:compute-ref #uuid "1e39414a-8aee-4a02-813a-577aa9caa2e3",
 :exec-duration 2891,
 :id "e54fb007-7eef-464a-b606-25acca055d6f",
 :kind "code",
 :output-log-lines {},
 :runtime [:runtime "c053cbfa-1fe0-440c-9da9-36d72eb0a7bc"]}},
"e5ea95df-6529-4a77-b596-5ac52d667f58"
{:compute-ref #uuid "f059550d-c62f-4e51-9159-50bb1959e659",
 :exec-duration 65992,
 :id "e5ea95df-6529-4a77-b596-5ac52d667f58",
 :kind "code",
 :output-log-lines {:stdout 161},
 :runtime [:runtime "c053cbfa-1fe0-440c-9da9-36d72eb0a7bc"]}},
"e6941cb3-40b2-4965-a7c8-1244bdc7b074"
{:compute-ref #uuid "d0bbbaaf-e714-4b4d-8b48-90049ff39510",
 :exec-duration 3590,
 :id "e6941cb3-40b2-4965-a7c8-1244bdc7b074",
 :kind "code",
 :output-log-lines {},
 :runtime [:runtime "c053cbfa-1fe0-440c-9da9-36d72eb0a7bc"]}},
"e9532bd3-e0d3-40ee-985f-4759118ede93"
{:compute-ref #uuid "661c0748-2fc6-4cbc-aaf3-25625e23335f",
 :exec-duration 502,
 :id "e9532bd3-e0d3-40ee-985f-4759118ede93",
 :kind "code",
 :output-log-lines {},
 :runtime [:runtime "c053cbfa-1fe0-440c-9da9-36d72eb0a7bc"]}},
"ef2873e6-e002-4091-afb3-6e47fc89aa0b"
{:compute-ref #uuid "743c6481-5837-40b8-ab67-2205103d66c3",
 :exec-duration 353,
 :id "ef2873e6-e002-4091-afb3-6e47fc89aa0b",
 :kind "code",
 :output-log-lines {},
 :runtime [:runtime "c053cbfa-1fe0-440c-9da9-36d72eb0a7bc"]}},
"f248cc25-8652-4bfa-a971-e1f67f45ef9b"
{:id "f248cc25-8652-4bfa-a971-e1f67f45ef9b", :kind "file"}},
:nextjournal/id #uuid "02ba02d5-83cf-4e51-8653-9c5130df0420",
```



```
:article/change
```

```
{:nextjournal/id #uuid "5f4fa0bc-00b2-48b8-8063-b313dc1297ca"}}
```

```
...
```

```
</details>
```



**American
Iron and Steel
Institute**

25 Massachusetts Avenue, NW
Suite 800
Washington, DC 20001
www.steel.org

