

Inelastic Performance of Welded CFS Strap Braced Walls

RESEARCH REPORT RP08-4

2008



American Iron and Steel Institute



Steel Framing Alliance™

Steel. The Better Builder.

DISCLAIMER

The material contained herein has been developed by researchers based on their research findings and is for general information only. The information in it should not be used without first securing competent advice with respect to its suitability for any given application. The publication of the information is not intended as a representation or warranty on the part of the American Iron and Steel Institute, Steel Framing Alliance, or of any other person named herein, that the information is suitable for any general or particular use or of freedom from infringement of any patent or patents. Anyone making use of the information assumes all liability arising from such use.

PREFACE

The *North American Standard for Cold-Formed Steel Framing - Lateral Design*, AISI S213-07, provides design provisions for cold-formed steel framed walls with diagonal strap bracing. Presented in this report are the findings from an extensive monotonic and cyclic testing program conducted at the McGill University to verify the capacity based design approach, the R_d and R_o values and the building height limit as found in AISI S213-07 for limited ductility concentrically braced frames with welded connections.

It is anticipated that the results of this study will be incorporated in future standards developed by the AISI Committee on Framing Standards and design aids developed by the Cold-Formed Steel Engineers Institute.

Inelastic Performance of Welded Cold-Formed Steel Strap Braced Walls

By

Gilles Comeau

Project Supervisor

Colin A. Rogers



McGill

Department of Civil Engineering and Applied Mechanics

McGill University, Montreal, Canada

June 2008

A thesis submitted to the Faculty of Graduate and
Postdoctoral Studies in partial fulfillment of the requirements
of the degree of Master of Engineering

© Gilles Comeau, 2008

ABSTRACT

As cold-formed steel construction grows in North America the void in our building codes must be filled. The NBCC and the CSA S136 Standard currently have no seismic provisions for cold-formed steel construction. Recently, the AISI has made available an updated version of AISI S213 which includes adaptations for use with Canadian codes. This standard gives guidance on the design and construction of cold-formed steel systems to be used for lateral load resistance and prescribes the use of a capacity approach for seismic design. Seismic force modification factors to be used in conjunction with the NBCC are recommended for two CBF categories; one for limited ductility ($R_d = 2.0$, $R_o = 1.3$), examined herein, and one for conventional construction ($R_d = 1.25$, $R_o = 1.3$). A building height limit of 20m for the limited ductility system is also recommended.

The main objective of this research was the verification of the capacity based design approach, the R_d and R_o values and the building height limit as found in AISI S213 for limited ductility CBFs. In order to achieve this, the lateral load carrying behaviour of weld-connected cold-formed steel strap braced walls was examined by means of laboratory testing (30 wall specimens). The wall aspect ratio was varied from 1:1 to 1:4 to look at its effect on stiffness and overall performance. Each of the wall specimens was tested using both a monotonic and the CUREE reversed cyclic protocols. Further to these laboratory experiments, non-linear dynamic time history analysis of a multi-storey structure, designed using the Canadian specific AISI S213 provisions and the NBCC, was carried out. ATC-63, a newly available method for determining the validity of R values, was used to check the AISI S213 design parameters. Input earthquake records (both synthetic and recorded) were scaled to the UHS for Vancouver, site class C.

Walls with aspect ratios of 1:1 and 1:2 showed the ability to sustain lateral loading well into the inelastic range thereby validating the capacity design procedure set out in AISI S213. Walls with an aspect ratio of 1:4, however, saw minimal brace yielding and are not recommended for use in design at this time. The calculated inelastic storey drifts and the failure probabilities from the ATC-63 procedure were acceptable, thereby verifying the use of $R_d = 2.0$ and $R_o = 1.3$ and the 20m building height limit for limited ductility CBFs.

RESUME

La croissance des constructions en structure d'acier laminé à froid dans l'Amérique du Nord nécessite le colmatage des carences pertinentes dans les codes nationaux du bâtiment. En effet, le Code National du Bâtiment du Canada (CNB) et la norme CSA S136 de l'Association Canadienne de Normalisation ne contiennent aucune directive portant sur la conception de structures en acier laminé à froid sous les charges sismiques. Récemment, l'American Iron and Steel Institute (AISI) a publié une mise-à-jour de la norme Américaine AISI S213 accommodant des ajustements aux codes Canadien. Cette norme comprend des recommandations visant la conception et la construction de structures en acier laminé à froid pour résister des charges latérales, et exige l'adoption d'une approche de conception sismique basée sur la capacité de la structure. Des facteurs de modification de force, utilisés en concordance avec le CNB, sont prescrits pour deux catégories de cadres à contreventement concentriques (CC): la première catégorie, traitée ci-dessous, est liée à un système de ductilité limitée ($R_d = 2.0$, $R_o = 1.3$), alors que la deuxième est relative à la construction traditionnelle ($R_d = 1.25$, $R_o = 1.3$). En plus, la hauteur des systèmes à ductilité limitée est plafonnée à 20 mètres.

L'objectif principal de la présente recherche est la vérification des méthodes de conception basées sur la capacité du système, les valeurs de R_d et de R_o , et la limite des hauteurs des bâtiments comme proposées par la norme AISI S213 pour un système à ductilité limitée. Afin de viser ce but, le comportement de 30 murs porteurs assujettis aux charges latérales est testé au laboratoire. Le rapport proportionnel des murs testés est varié entre 1 : 1 et 1 : 4 pour examiner son effet sur la rigidité et le comportement global des murs sous les charges d'essais. Chacune des murs est testée en utilisant un protocole de chargement monotone et le protocole de chargement cyclique-réversible du CUREE. Une structure typique à niveaux multiples est modélisée et analysée en sus des essais de laboratoires. Cette structure est conçue en conformité avec les clauses Canadiennes de la norme AISI S213 et du CNB. Une analyse dynamique temporelle non-linéaire y est appliquée. La validation des paramètres de conception tels que proposés par la norme AISI S213 est menée suivant la nouvelle méthode de vérification de la rigueur des facteurs R dite ATC-63. Les signaux sismiques (synthétiques ou enregistrées) sont calibrées par rapport au SURS de Vancouver – Site Classe C.

Les murs dont les rapports proportionnels sont de 1:1 et 1:2 ont bien soutenu des charges latérales en pleine zone inélastique, validant ainsi les méthodes de conception basées sur la capacité de la structure proposées par la norme AISI S213. Par contre, les murs ayant un rapport proportionnel de 1:4 ont exhibé une déformation minimale des contreventements ; leur utilisation doit être déconseillée pour le moment. Les probabilités de défaillance et les déversements inélastiques obtenus par la méthode ATC-63 sont acceptables, démontrant alors la validité des valeurs exigées de $R_d = 2.0$ et $R_o = 1.3$ ainsi que la rigueur de la limite de hauteur de 20 mètres imposée aux contreventements concentriques de ductilité limitée.

ACKNOWLEDGEMENTS

I would like to thank the funding partners who continue to make this research a reality: The Canadian Sheet Steel Building Institute, the Canada Foundation for Innovation, the Natural Sciences and Engineering Research Council and the American Iron and Steel Institute. I also wish to thank the materials suppliers: ITW Buildex, Bailey Metal Products, Grabber Construction Products, Simpson Strong-Tie and the CANAM Group for their help with the research.

TABLE OF CONTENTS

ABSTRACT	i
RESUME	ii
ACKNOWLEDGEMENTS.....	iv
TABLE OF CONTENTS	v
LIST OF FIGURES	ix
1.0 Introduction.....	1
1.1. General Overview	1
1.2. Statement of Problem.....	3
1.3. Objectives	4
1.4. Scope.....	5
1.5. Literature Review.....	6
1.5.1. Laboratory testing	6
1.5.2. Design Standards	9
1.5.3. Dynamic Analysis.....	12
1.5.3.1. <i>Braced frames</i>	12
1.5.3.2. <i>Shear walls</i>	14
1.5.4. Ground Motion Selection and Incremental Dynamic Analysis	16
1.5.5. Conclusion	18
2.0 Test Program.....	20
2.1. Overview of Wall Specimens and Test Apparatus	20

2.2.	Capacity Design Approach	23
2.3.	Development of Welding Protocol	33
2.3.1.	Welding Procedure.....	33
2.3.2.	Weld Testing.....	35
2.4.	Construction Details.....	38
2.4.1.	General Fabrication and Construction Details	38
2.4.2.	Heavy Wall Weld Connection Details	42
2.5.	Test Instrumentation and Installation.....	43
2.6.	Monotonic Load Protocol	45
2.7.	Reversed Cyclic Load Protocol	46
2.8.	Analysis of Measured Test Data	48
2.8.1.	Lateral Wall Resistance	48
2.8.2.	Lateral Wall Stiffness	51
2.8.3.	Seismic Force Modification Factors	54
2.8.4.	Energy Calculations	56
2.9.	Material Properties.....	56
2.10.	Observed Performance.....	58
2.10.1.	Light Walls.....	60
2.10.2.	Medium Walls.....	61
2.10.3.	Heavy Walls.....	63
2.11.	Summary and Discussion of Test Results.....	64
2.11.1.	Lateral Wall Resistance	64
2.11.2.	Lateral Wall Stiffness	67

2.11.3.	Seismic Force Modification Factors	68
2.11.4.	Energy Calculations	69
2.11.5.	General Discussion	70
3.0	Dynamic Analysis	75
3.1.	Model Building Design	77
3.1.1.	2005 NBCC Base Shear Calculation	81
3.1.2.	Design of Strap Braces.....	85
3.1.2.1.	<i>Minimum Brace Size Selection Criterion</i>	86
3.1.2.2.	<i>Two Brace Size Selection Criterion</i>	87
3.1.3.	Shear Deflection.....	88
3.1.4.	Second Order Effects (P- Δ)	90
3.2.	Hysteresis Calibration of Braced Wall Element	92
3.3.	Development of Building Model in RUAUMOKO.....	95
3.4.	Ground Motion Selection and Scaling.....	97
3.5.	ATC-63 Based R-Factor and Height Limit Verification	103
3.5.1.	Incremental Dynamic Analysis.....	104
3.5.2.	Fragility Curve Development	105
3.5.2.1.	<i>Determination of Spectral Shape Factor</i>	107
3.5.2.2.	<i>Determination of Total System Collapse Uncertainty</i>	108
3.6.	Summary and Discussion of Analyses Results	111
3.6.1.	Model Comparison.....	111
3.6.2.	Preliminary Analyses	113

3.6.3.	Final Analyses.....	116
3.6.4.	General Discussion	120
4.0	Conclusions and Recommendations	122
4.1.	Conclusions.....	122
4.1.1.	Test Program.....	122
4.1.2.	Dynamic Analysis.....	123
4.2.	Recommendations for Future Studies.....	124
	References.....	126
	Appendix A: Individual Test Results Summaries.....	131
	Appendix B: Nominal Dimensions and Specifications of All Walls.....	162
	Appendix C: Strain Gauge Locations	173
	Appendix D: Reversed Cyclic Test Protocols	177
	Appendix E: Test Data Sheets and Observations.....	188
	Appendix F: Model Design Summaries.....	231
	Appendix G: RUAUMOKO Input Files	236
	Appendix H: Example Hystereses and Time Histories.....	251
	Appendix I: Dynamic Analyses Results	258
	Appendix J: Tables with US Customary Units	272

LIST OF FIGURES

Figure 1.1: Example of building with weld connected strap braces (<i>Courtesy of CWMM Vancouver</i>)	2
Figure 1.2: Definition of NBCC lateral design force, V , in terms of ductility and overstrength related force modification factors	10
Figure 2.1: Schematic of displaced strap braced wall in test frame.....	20
Figure 2.2: Extended and regular track detail showing track force	28
Figure 2.3: Whitmore section diagram	31
Figure 2.4: Example holddown fixture installed in back-to-back chord stud (<i>Left: Simpson Strong-Tie Co., 2005</i>)	33
Figure 2.5: Welding setup and Lincoln Electric GMAW welder	34
Figure 2.6: Welding process and partially finished weld pattern on a medium wall	35
Figure 2.7: Welded strap sample undergoing tension test, failures for three strap sizes	35
Figure 2.8: Polished cross section of weld connection between gusset plate and strap	37
Figure 2.9: Shear anchor and anchor rod locations.....	39
Figure 2.10: Assembled walls in laboratory; final welding of gusset plates and straps	39
Figure 2.11: Corner details for 2440 x 2440mm light, medium and heavy walls	41

Figure 2.12: Nominal dimensions and specifications of light walls 13A-M and 14A-C	41
Figure 2.13: Connection failure of preliminary test 21A-M.....	42
Figure 2.14: Positioning of LVDTs and cable-extension transducer.....	44
Figure 2.15: Typical lateral resistance versus wall top deflection for a monotonic test	45
Figure 2.16: Typical lateral resistance versus wall top deflection for a reversed cyclic test.....	47
Figure 2.17: Typical reversed cyclic test protocol.....	47
Figure 2.18: Definition of measured and predicted properties for monotonic tests	49
Figure 2.19: Definition of measured and predicted properties for cyclic tests.....	50
Figure 2.20: Components contributing to predicted stiffness, K_p	53
Figure 2.21: Light walls 16A-C and 16B-C.....	60
Figure 2.22: Yielding in light walls	60
Figure 2.23: Medium walls showing brace yielding.....	61
Figure 2.24: Medium wall strap connection prior to testing and after net section strap failure at 7.8% drift	62
Figure 2.25: Chord stud failure in specimens 19B-M1 and 19B-M2	62
Figure 2.26: Net section strap failure of specimen 23A-M2 at 8.2% drift	63
Figure 2.27: Post test specimen 24B-C (1220 x 2440mm); specimen 24C-C (610 x 2440mm)	64

Figure 2.28: Resistance vs. lateral drift hystereses for heavy walls 24A-C (1:1), 24B-C (1:2) and 24C-C (1:4)	65
Figure 2.29: Comparison of brace stress with lateral drift for the 1:1, 2:2 and 1:4 aspect ratio walls	67
Figure 2.30: Normalized energy from monotonic test results	69
Figure 3.1: Elevation and plan view of model 6S R _d R _o 2.6-minbrace	78
Figure 3.2: Braced wall location for model 6S R _d R _o 2.6-minbrace a) E-W direction earthquake, and b) N-S direction earthquake	79
Figure 3.3: Hambro® D500 floor system (<i>Canam Group, 2004</i>)	79
Figure 3.4: Design UHS for Vancouver, site class C	83
Figure 3.5: Inter-storey drift variables	89
Figure 3.6: Bi-linear with slackness hysteresis (<i>Carr, 2000</i>)	92
Figure 3.7: Example of matched hysteretic behaviour between model and laboratory test result 24A-C	93
Figure 3.8: a) Schematic of a six storey shear wall tower, and layout of b) stick model and c) full brace/chord stud model	96
Figure 3.9: NBCC UHS used for design and example scaled synthetic earthquake record spectrum	99
Figure 3.10: Ground motion spectra scaled to Vancouver site class C UHS	101
Figure 3.11: Mean scaled earthquake spectra compared to design UHS	102
Figure 3.12: IDA curve for model 6S R _d R _o 2.6-minbrace	105
Figure 3.13: Fragility curve for model 6S R _d R _o 2.6-minbrace	106

Figure 3.14: Static pushover analysis for a) six storey models, b) seven storey models	107
Figure 3.15: Schematic showing seismic load distribution for pushover analysis	108
Figure 3.16: a) Pushover analysis and b) Mean Inter-storey drift comparison based on seven earthquake records for models 6S R _d R _o 2.6-minbrace and 6S full brace/chord stud.....	112
Figure 3.17: Storey height versus inter-storey drift for 2S R _d R _o 2.6-minbrace and 4S R _d R _o 2.6-minbrace models.....	114
Figure 3.18: Storey height versus inter-storey drift for 6S R _d R _o 2.6-minbrace and 7S R _d R _o 2.6-minbrace models.....	115
Figure 3.19: Fragility curves for a) six storey models, and b) seven storey models	118
Figure 3.20: Uncertainty adjusted fragility curves for a) six storey models and b) seven storey models	119

LIST OF TABLES

Table 2.1: Matrix of strap braced wall test specimens.....	22
Table 2.2: Probable forces in SFRS due to brace yielding	26
Table 2.3: Nominal axial compression capacity of back-to-back chord studs.....	27
Table 2.4: Nominal track compression, tension and bearing capacities	28
Table 2.5: Strap weld design lengths and capacities.....	30
Table 2.6: Nominal gusset plate resistance based on Whitmore section calculation	31
Table 2.7: Material properties of strap braces.....	57
Table 2.8 : Material properties of studs, tracks and gusset plates.....	58
Table 2.9: Summary of failure modes.....	59
Table 2.10: Comparison of measured, predicted and nominal elastic stiffness and yield resistance for monotonic tests	71
Table 2.11: Comparison of measured, predicted and nominal elastic stiffness and yield resistance for cyclic tests.....	72
Table 2.12: Other measured test properties for monotonic tests.....	73
Table 2.13: Other measured test properties for cyclic tests	74
Table 3.1: General model parameters	77
Table 3.2: Specified dead, live and snow loads	81
Table 3.3: Summary of design storey shear for building 6S R _d R _o 2.6-minbrace ..	85
Table 3.4: Example of chosen strap sizes (6S R _d R _o 2.6-minbrace).....	87
Table 3.5: Elastic inter-storey drift calculation (6S R _d R _o 2.6-minbrace).....	92

Table 3.6: Periods of vibration for stick models.....	96
Table 3.7: Summary of ground motions for Vancouver, site class C.....	98
Table 3.8: Determination of total system collapse uncertainty.....	109
Table 3. 9: Periods of vibration for full brace/chord stud models	111
Table 3.10: Inter-storey drift based on the seven earthquake records	116
Table 3.11: Median and maximum inter-storey drifts for six storey models.....	117
Table 3.12: Median and maximum inter-storey drifts for seven storey models .	117
Table 3.13: Parameters for determining model acceptance	119
Table 3.14: Failure probabilities at design level ground motion	120

1.0 INTRODUCTION

1.1. General Overview

The design of structures to resist rare events such as earthquakes is extremely important to avoid complete structural failure (collapse), which can lead to loss of life. In Canada, the West Coast and the Saint Lawrence and Ottawa River valleys are areas of high seismic hazard where, generally, the governing load case will involve earthquake loading. Furthermore, the newest edition of the National Building Code of Canada (NBCC) (*NRCC, 2005a*) requires seismic design calculations for all areas of the country and now uses a 2% in 50 year probability of exceedance, compared with 10% in the previous edition. This means that rarer ground motions must now be considered in design.

As building materials evolve it is necessary to quantify their behaviour to provide information to designers. The current NBCC and material specific Canadian Standards Association (CSA) S136 Standard (*CSA S136, 2007*) have no provisions for the design of cold-formed steel (CFS) construction as a seismic force resisting system (SFRS). To address this lack of design information the research documented herein was carried out. The research provides further understanding of the inelastic behaviour of strap braced CFS walls designed and detailed using welded connections to resist seismic loading (Figure 1.1). The load levels which CFS framing can resist are comparable to those of regular wood framed construction; generally residential or smaller commercial structures.



Figure 1.1: Example of building with weld connected strap braces (*Courtesy of CWMM Vancouver*)

Braced walls form a vital component of the load transfer mechanism within a structure which channels lateral loads, such as wind or earthquake, from upper storeys to the foundation. CFS strap braced walls use four main elements to transfer these loads: diagonal flat strap braces, horizontal tracks, vertical chord studs, and holddown/anchor rod fixtures at the corners. Previous research at McGill University (*Al-Kharat & Rogers, 2005, 2006, 2007, 2008*) has detected deficiencies in the design and detailing of these elements which have been addressed in the American Iron and Steel Institute's North American lateral design standard for CFS framing, AISI S213 (*2007*).

The use of CFS as a construction product is becoming increasingly popular in North America. With this increase in popularity comes the need to update and add to current design standards to accommodate and guide the construction industry and designers. The goal of this research was to evaluate the performance of weld connected strap braced walls through full scale laboratory testing and multi-storey non-linear time history dynamic analysis; and, to provide confirmation of the newly adopted Canadian seismic design provisions for CFS braced walls in AISI S213.

1.2. Statement of Problem

Currently, the 2005 NBCC and the CSA S136 Standard do not contain provisions specific to the seismic design of CFS framed structures. A North American design standard for lateral systems constructed of CFS (AISI S213) has been made available by the American Iron and Steel Institute (*AISI, 2007*). This standard contains provision for the seismic design of CFS systems intended for use with the NBCC. The AISI S213 document contains requirements for brace material and the use of capacity design principles, and also directs the designer toward the use of welded connections. Recommendations for R_d and R_o , the seismic force ductility and overstrength modification factors used in the NBCC, as well as a building height limit, are given.

Apart from the deficiencies with the NBCC, no physical tests of welded strap braced walls with an aspect ratio other than 1:1 have been done. Similarly, dynamic analyses of CFS strap braced walls aimed at evaluating the performance

of multi-storey structures and the height limits provided in AISI S213 have yet to be carried out.

Prior research at McGill University by Al-Kharat and Rogers (2005, 2006, 2007, 2008) on CFS strap braced walls has resulted in recommendations regarding the use of capacity design procedures. This work highlighted the importance of screwed connection detailing but few tests have been carried out on welded strap connected walls.

1.3. Objectives

The objectives of this research include:

1. To review the previous CFS strap braced shear wall research (*e.g. Al-Kharat & Rogers, 2006; Kim et al., 2006*) and identify areas in need of improvement based on these prior studies.
2. To develop a testing program specific to weld connected CFS strap braced single storey walls designed using AISI S213, including capacity design principles; and to carry out the fabrication and testing of each specimen in the laboratory.
3. To construct dynamic models of multi-storey structures calibrated to the laboratory test data and subject them to a set of chosen earthquake records using non-linear time history dynamic analysis software.
4. To interpret all testing and modeling results and discuss the findings with respect to the seismic design approach provided in AISI S213 and to provide

recommendations on R values, building height limit restrictions and material requirements with respect to weld connected strap braced walls.

1.4. Scope

The research comprised monotonic and reversed cyclic tests on a total of thirty single-storey wall specimens designed to different lateral load levels and with various aspect ratios. Their inelastic lateral load carrying capacity and performance were evaluated. All specimens had diagonal cross bracing welded on both sides. Three factored lateral load levels were used in design; 20kN (light), 40kN (medium) and 75kN (heavy). The thesis contains a presentation of the measured parameters, including lateral load and displacement, as well as strain of the strap braces. Properties such as wall stiffness, ductility and energy absorbed were calculated from the measured parameters. Seismic force modification factors for the specimens were estimated from the test data and compared with current values recommended in AISI S213.

The laboratory test data was also used to calibrate computer models to gain a better understanding of the behaviour of this type of SFRS in a multi-storey setting. Non-linear time history dynamic analysis was used to evaluate wall performance in two, four, six and seven storey example structures located in Vancouver, BC, Canada. A total of 45 earthquake records were selected and scaled to match design level ground motions from the 2005 NBCC uniform hazard spectrum. A number of strategies were also implemented for the design of the representative buildings modeled for the analyses. The dynamic analysis

procedure given by ATC-63 (2008) and modified for Canadian design was followed. Under this procedure, incremental dynamic analysis was used to create fragility curves for each model variation in order to verify the design R values and height limit for the limited ductility concentrically braced frame (CBF) category.

1.5. Literature Review

A review of available literature related to CFS strap braced walls and relevant dynamic analysis techniques has been carried out. The literature review is broken into three sections to allow for a better appreciation of the research that has been completed prior to this study; laboratory testing, design standards and dynamic analysis.

1.5.1. Laboratory testing

Testing of CFS framed shear walls began in the late 1970s by Tarpy at Vanderbilt University (*McCreless & Tarpy, 1978; Tarpy & Hauenstein, 1978*). Originally only walls sheathed with wood panels and/or gypsum were tested. It was not until 1990 that cold-formed steel strap braces were incorporated into the SFRS (*Adham et al., 1990*). Since this time many different testing programs have been developed and much work has been done to solve the problems associated with this type of SFRS. Al-Kharat & Rogers (2006) have presented a literature review covering previous research projects so only a brief overview will be provided here.

Adham et al. (1990) experimented with straps of different thicknesses as well as gypsum sheathing in combination with the strap braces. Adham et al. showed that

stud buckling can be a problem, but when properly designed for, the straps will yield as desired. Research has also been carried out by Serrette & Ogunfunmi (1996), Barton (1997), Gad et al. (1999a, b, c), Fülöp & Dubina (2004a), Tian et al. (2004), Casafont et al. (2006), and Al-Kharat & Rogers (2005, 2006, 2007, 2008). All of these research projects vary in the size and detailing of the strap brace, holddown type and location, and load type. Most have used a combination of monotonic and cyclic loading protocols while some used shake table tests to determine wall performance. Recommended $R_d \times R_o$ values calculated based on the ductility and overstrength of these tests vary from 1.5 to 3.65 depending on wall design, strap connection and the holddown/anchor rod detail.

Full scale monotonic and cyclic screw connected braced wall tests by Al-Kharat & Rogers (2006, 2008) illustrated that when a capacity design approach was used, the desired performance (strap yielding) could be achieved. This was done by selecting the strap braces as the fuse element and designing other wall components based on the probable capacity of the braces. Brace failure by net section fracture was found during some reversed cyclic tests (0.5Hz). This non-ductile failure mode occurred at the screwed connection location even when a capacity approach had been utilized in design. This was only seen in the light (lowest load level group) and heavy (highest load level group) walls and was attributed to the F_u/F_y ratio of 1.11 which was recorded for both groups through coupon testing. An F_u/F_y ratio greater than 1.20 was recommended for the strap

material such that net section fracture can be avoided. Al-Kharat & Rogers also found deficiencies in predicting the lateral in-plane stiffness of these walls.

Full scale shake table tests of a two storey CFS framed strap braced structure were carried out by Kim et al. (2006). The structure had concrete floors for mass and was designed and detailed using the US Army Corps of Engineers TI 809-07 (2003) technical instructions. Strap braces were weld connected to the chord studs, which were in turn welded to a holddown device. It was concluded that overall good behaviour of the strap braces can be expected only if brace fracture caused by improper weld or screw connections is prevented. The R factor for design recommended by TI 809-07 is 4.0; however, the test specimen was designed with an R factor of 5.47. Yielding of the first floor straps occurred, while the braces on the second floor (top storey) stayed in the elastic range as was expected. Column strains were monitored and used to determine the presence of end moments within the chord studs during testing, suggesting that they do provide some contribution to energy dissipation.

A study by Filiatrault & Tremblay (1998) on the design of tension-only concentrically braced frames (TOCBF) for seismic impact loading used hot rolled steel as the brace material. Shaketable test results from a two storey TOCBF structure and subsequent high strain rate tests on coupon samples revealed that an amplification factor of 1.15, applied to the yield tensile resistance, is appropriate for use in capacity based design. Previous tests (Tremblay & Filiatrault, 1996)

have shown that this increase in tensile capacity is not the result of impact loading, but rather the result of increased tensile strength of the braces under high strain rate. This factor was verified through a design example and computer analysis.

Hatami et al. (2008) conducted laboratory tests on 2.4m x 2.4m wall specimens using different strap connection locations and configurations. For these cyclically loaded tests gravity effects were accounted for by use of vertical actuators and a roller-bearing setup (load applied along top track). Some walls were clad on one side with gypsum while others were not. It was found that when the straps were attached to the tracks away from the corners wall performance was poor due to track bending and early buckling of studs located adjacent to brace ends. Perforated straps were experimented with. It was found that the perforations eliminated the brittle failure mode of net section fracture at connection screw hole locations and allowed for ductile behaviour.

1.5.2. Design Standards

Design standards pertaining to this research were reviewed as one of the aims of this project. The current edition of the NBCC and the CSA S136 Standard (2007) do not contain any specific recommendations for seismic design with CFS framed structures.

Seismic force modification (R) factors for use with the Canadian building code have been derived for many types of SFRSs; their derivation is well explained in

the landmark paper by Mitchell et al. (2003). Figure 1.2 shows a graphical representation of the definitions of R_d , the ductility related overstrength factor, and R_o , the material overstrength factor, as they are applied in the NBCC. Mitchell et al. do not give any guidance for R factors for CFS bracing systems.

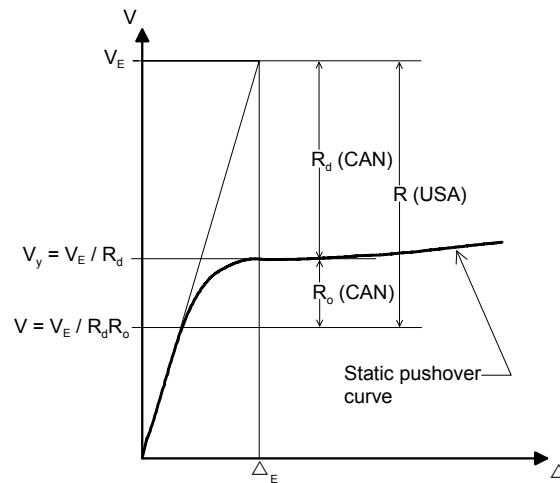

Figure 1.2: Definition of NBCC lateral design force, V , in terms of ductility and overstrength related force modification factors

The product of $R_d R_o$ can be considered as being similar to the R factor used in the US loading standard ASCE/SEI 7-05 (2005) (Figure 1.2). This is important to note because the seismic design and analysis techniques carried out in this thesis are in part based on American literature but at the same time the goal is to develop methods which are relevant to the development of Canadian codes.

A North American lateral design standard for CFS framing, AISI S213 (2007), has recently been adapted for use with the Canadian building code. The AISI document recommends the use of $R_d = 2.0$ and $R_o = 1.3$ for limited ductility (Type LD) CBFs, and $R_d = 1.25$ and $R_o = 1.3$ for conventional construction (Type CC) frames. A building height limit for the LD CBF of 20m exists for the various

seismic zones across the country. Conventional construction CBFs are limited to 15m in height when $IEF_a S_a(0.2) < 0.35$ and not permitted otherwise. Specific to diagonal strap bracing when $R_d R_o > 1.625$ (Type LD braced frames) is Clause C5.2 of the standard, in which a capacity approach is outlined for the design of the elements in the SFRS. Grade dependant values of R_t and R_y are given to quantify the probable strength of the braces for use with capacity design. These factors allow the designer to increase the minimum specified ultimate and yield strengths, F_u and F_y , respectively, in order to design at the probable force level. The standard also directs engineers toward the use of welded connections to avoid the net section fracture failure mode. The development of these provisions was for the most part based on the findings and recommendations of Kim et al. and Al-Kharat & Rogers.

The American Society of Civil Engineers ASCE/SEI 7-05 Standard (2005) entitled “Minimum Design Loads for Buildings and Other Structures” provides minimum load requirements for the design of buildings and structures and allows an R value of 3.25 to be used when designing with ordinary concentrically braced CFS frames. If $R = 4.0$ is used in design, then reference is made to AISI S213, where the engineer will find information to be used for detailing the SFRS, i.e. capacity design requirements.

The US Army Corps of Engineers TI 809-07 Technical Instructions (2003) is another design standard which is specific to the use of CFS framing. It

recommends an R value of 4.0 (for use with American codes) for strap braced walls and also recommends that a capacity design approach be followed.

1.5.3. *Dynamic Analysis*

1.5.3.1. *Braced frames*

Barton (1997) and Gad et al. (1999c) completed a 3D finite element (FE) study to compare with their laboratory results on the shake table testing of a one room house. The model of a bare steel frame included the effects of brace connections, a strap tensioner unit which was included in the specimens, and also looked at the effects of gypsum sheathing. The non-linear FE modeling was done by Barton using ANSYS (1994) and included both elastic and inelastic element properties. Yield displacement based modeling procedures were based on recommendations by Park (1989). Comparisons were made between analytical and experimental values and it was concluded that the model accurately predicted deformation under varying load levels and boundary conditions. The non-linear time history dynamic analysis was used to derive a ductility related response modification coefficient for seismic design (R_d) and to evaluate a simple procedure to predict the period of vibration of CFS braced structures. Recommended R values from this study ranged from 1.5 to 3.5. An evaluation of the overstrength related seismic force modification factor was also provided.

This study also looked at the effects of changing wall aspect ratios in an attempt to quantify whether extrapolation of results from a typical 1:1 ratio test was

possible. This information was thought useful to designers who are not always so fortunate to have 1:1 shear walls. Aspect ratios ranging from 1:4 to 2:1 (length: height) were modeled using the exact same parameters (connections and elements) as their 1:1 counterparts. Though no full scale laboratory tests were done, the FE results show that the wall capacity with varying aspect ratio is not linearly proportional to wall length. A 1:4 wall will achieve about 1/3 the ultimate load of its 1:1 counterpart, which is a product of the change in geometry, but more interestingly the elastic stiffness of this wall will be greatly decreased, hence a much more flexible system is created. This study did not consider multi-storey structures.

Pastor & Rodríguez-Ferran (2005) developed a hysteretic model which can be used for non-linear dynamic analysis of cross braced walls. The hysteretic response was modeled as a small system of ordinary differential equations. They concluded that accurate predictions of reversed cyclic behaviour could be obtained. Hysteresis models were used to simulate strap behaviour which included an initial stiffness, a post yield stiffness (strain hardening) and strap slackness. The finite element analysis compares results obtained from treating the wall as a single degree of freedom (SDOF) system and a multi degree of freedom (MDOF) system. The results closely match and it is concluded that a SDOF analysis is adequate. Coupled walls (side by side) were also modeled and performed as expected. No multi storey structures were modeled in this study.

Efforts to match test results from the previously mentioned shake table testing of a two storey CFS structure (*Kim et al., 2006*) were made using dynamic analysis (*Kim et al., 2007*). To match the hysteretic behaviour both the strap braces and columns were modeled using elements with non-linear properties from the DRAIN-2DX non-linear dynamic analysis software (*Prakash et al., 1993*). It was found that close attention should be paid to unintentional shaketable rocking motions caused by overturning, and that this must be considered in the model to match actual behaviour. With this taken into account, by modeling vertical springs at the wall base, a very good hysteretic match was obtained. The authors also pointed out that a simpler model, using an inelastic truss bar element to represent strap behaviour, can reproduce overall wall performance.

1.5.3.2. Shear walls

Blais (*2006*) presents a literature review which includes details on studies related to wood sheathed shear walls. Although the hysteretic wall behaviour is not the same as that of strap braced walls the analysis techniques are relevant and are briefly mentioned here. Della Corte et al. (*2006*) studied the behaviour of these walls using a SDOF one storey model. Twenty six earthquake records were chosen and incremental dynamic analysis (IDA) was carried out. Fülöp & Dubina (*2004b*) used five earthquake records along with DRAIN-3DX non-linear dynamic analysis software (*Prakash et al., 1994*) to create IDA curves for a SDOF model. The shear walls were sheathed with oriented strand board (OSB) panels and corrugated sheathing. Earthquake scaling ranged from 0.05g to 2.0g to facilitate IDA analysis.

Blais' study uses RUAUMOKO (*Carr, 2000*) to run the non-linear dynamic analysis. Ten earthquake records were chosen, four synthetic and six real. Earthquake scaling was done by matching the earthquake record response spectrum to the 2005 NBCC design response spectrum for Vancouver. One, two and three storey MDOF models were constructed which simulated the behaviour of wood sheathed walls. The 2005 NBCC equivalent static design method, along with R_d , R_o , strength and stiffness values from analytical testing, was used for each model. The results showed that the shear walls were able to perform within test based allowable drift limits under the chosen ground motions, and therefore confirmed the validity of the design method.

A procedure for determining test based R values is presented by Boudreault et al. (*2007*). The study is aimed at determining appropriate R_d and R_o values for use with the 2005 NBCC; wood sheathed shear walls were subjected to monotonic and reversed cyclic testing. The ductility related force modification factor, R_d , was developed using the Newmark & Hall (*1982*) period specific equation (Equation 1-1). The overstrength related force modification factor, R_o , was found using the relevant components of Equation 1-2 (*Mitchell et al., 2003*).

$$R_d = \sqrt{2\mu - 1} \quad \text{for } 0.1 < T < 0.5\text{s} \quad (1-1)$$

$$R_o = R_{\text{size}} R_{\phi} R_{\text{yield}} R_{\text{sh}} R_{\text{mech}} \quad (1-2)$$

where,

μ = as defined in Section 2.8.3

R_{size} = overstrength resulting from restricted member size choices and rounding

R_{ϕ} = $1/\phi$, the inverse of the material resistance factor

R_{yield} = factor to account for difference between nominal and actual yield strength

R_{sh} = factor to account for material strain hardening

R_{mech} = factor to account for resistance developed before a collapse mechanism forms in the structure

Once R values were found non-linear dynamic analysis was completed using RUAUMOKO (Carr, 2000). Results from models of two and three storey structures subjected to ten ground motion records were similar to that of Blais (2006) in that they showed wall performance was within test based drift limits.

1.5.4. Ground Motion Selection and Incremental Dynamic Analysis

Atkinson (2008) has made available a database of synthetic earthquake time histories which are compatible with the 2005 NBCC uniform hazard spectrum (UHS). The time histories were developed using the stochastic finite-fault method and are based on site classifications A, C, D and E as used by the current edition of the NBCC and ASCE/SEI 7-05. The synthetic ground motions incorporate finite fault effects such as the geometry of larger ruptures and its influence on ground motion excitation and attenuation. The database is of value because the evaluation of buildings by means of time history dynamic analyses requires the input of ground motion records. Since a sufficient number of real earthquakes has

not yet been recorded or taken place for some locations in Canada it is often necessary to rely on the use of synthetically derived ground motions records.

Vamvatsikos & Cornell (2002) have developed a technique to evaluate the required ground motion intensity to cause structural collapse. This technique, called incremental dynamic analysis (IDA), uses scaled ground motion records applied to a building model. Scaling of the earthquake records is increased until it results in failure of the building or the achievement of a specified inelastic drift limit. Damage measures such as maximum inter-storey drift or rotation can be used to evaluate the performance of the building as the intensity of the earthquake is increased. The IDA method is useful for determining collapse probabilities and levels of safety against design level earthquakes.

The Applied Technology Council (ATC) (2008) has developed a method to evaluate R values and height limits for seismic force resisting systems through a project entitled ATC-63. Within this document a method of determining collapse probability through the use of a collapse fragility curve is described. The ATC-63 methodology makes use of the IDA method in its procedure. The document is aimed at the development of R factors for seismic design with American codes and provides guidelines on design, model selection, input ground motion, and results interpretation and analysis. Modeling uncertainty is taken into account using this probabilistic approach.

1.5.5. Conclusion

The information gathered from the reviewed sources helped in the development of the design method used for the test walls and for the dynamic analyses documented in this thesis. The research described above was relied on to improve previous testing and analysis techniques where deficiencies were found and to be consistent with previous research to facilitate results comparison.

The design of the laboratory testing specimens followed recommendations by Al-Kharat & Rogers (2006, 2008), AISI S213 (2007), ASCE/SEI 7-05 (2005) and TI 809-07 (2003) in that a capacity based design approach was used. In order to avoid the net section fracture strap failures, seen by Al-Kharat & Rogers at higher strain rates, welded strap and gusset plate connections were used. Welded strap connections are also promoted by the AISI S213 standard. The test program also includes walls with different aspect ratios. This was previously explored by Barton (1997) and Gad et al. (1999c) through FE modeling but has not been verified by means of testing, and furthermore has not been examined for walls with welded connections.

The dynamic analysis procedure, from design to modeling to earthquake selection has been drawn from many sources. Design follows the 2005 NBCC equivalent static load procedure but uses R factors outlined by AISI S213. The model and its elements are similar to that used by Blais (2006). Pastor & Rodríguez-Ferran (2005) showed that a SDOF model for a one storey structure is adequate,

therefore the multi-storey models in this thesis have one degree of freedom per storey; in effect a number of stacked SDOF models. Assumptions used by Blais, such as infinitely rigid chord studs and rigid diaphragm action, have also been adopted in this thesis.

2.0 TEST PROGRAM

2.1. Overview of Wall Specimens and Test Apparatus

During the summer of 2007 monotonic and reversed cyclic tests of thirty weld connected strap braced cold-formed steel walls were carried out in the Jamieson Structures Laboratory at McGill University. The walls were divided into three configurations based on the lateral load level used for design. There were three different wall aspect ratios included in the testing matrix. Wall outside dimensions were 2440 x 2440mm (8' x 8'), 1220 x 2440mm (4' x 8') and 610 x 2440mm (2' x 8') (Aspect ratios, defined as length : height, of 1:1, 1:2 and 1:4 respectively). The test frame was the same as that used for previous strap braced wall tests and is specifically designed for in-plane shear loading as shown in Figure 2.1.

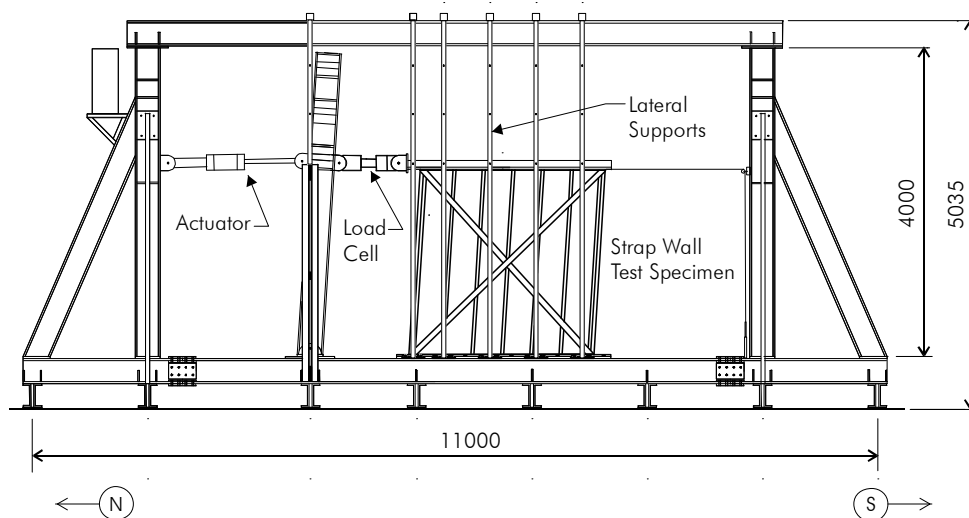

Figure 2.1: Schematic of displaced strap braced wall in test frame

Wall design was carried out using a capacity approach as found in AISI S213 (2007). The straps were selected as the fuse element and designed to enter into the

inelastic range while maintaining their yield capacity; all other components in the seismic force resisting system (SFRS) were designed to carry the probable capacity of the braces without failing. In order to cover a variety of potential building layouts and sizes three wall configurations, named light, medium and heavy, were included in the testing matrix. These configurations represent design lateral factored loads of 20, 40 and 75kN, respectively, for the 1:1 walls. A complete list of test specimens and their components, including straps, chord studs, interior studs, tracks and gusset plates is shown in Table 2.1.

Every test specimen had four anchor rods installed through the holddowns on the top and bottom tracks; one at each corner of the wall. The top of the wall was connected by means of shear anchors to the loading beam through a 25mm (1") thick aluminium spacer plate. The bottom of the wall was connected with shear anchors directly to the frame through a similar plate.

During testing the straps running from the bottom north corner to the top south corner were screw connected to the interior studs with No. 8 x 1/2" (13mm) self drilling wafer head screws, while the bottom south to top north straps were not. The intent was to observe whether the holes in the strap braces caused by the screws would affect the ductility levels reached by the walls. In the case of the monotonic tests, each wall was tested twice; the first test was used to evaluate the performance of the braces without screws, whereas the second test on the wall

was run in the opposite direction to apply loading to the brace with additional screws.

Table 2.1: Matrix of strap braced wall test specimens

Specimen properties ^a	Test specimens					
	Light		Medium		Heavy	
	13A-M (1:1) 14A-C (1:1)	15A-M (1:1) 16A-C (1:1) 15B-M (1:2) 16B-C (1:2)	17A-M (1:1) 18A-C (1:1) 19B-M (1:4) 20B-C (1:4)	19A-M (1:1) 20A-C (1:1)	21A-M (1:1) 22A-C (1:1) 23B-M (1:2) 24B-C (1:2) 23C-M (1:4) 24C-C (1:4)	23A-M (1:1) 24A-C (1:1)
Strap bracing (cross brace on both sides of wall)						
Thickness, mm (in)	1.09 (0.043)		1.37 (0.054)		1.73 (0.068)	
Width, mm (in)	63.5 (2.5)		69.9 (2.75)		101.6 (4)	
Grade, MPa (ksi)	230 (33)		340 (50)		340 (50)	
Chord studs (double studs screwed together back-to-back)						
Thickness, mm (in)	1.09 (0.043)		1.37 (0.054)		1.73 (0.068)	
Dimensions, mm (in)	92x41x12.7 (3-5/8x1-5/8-1/2)		152x41x12.7 (6x1-5/8x1/2)		152x41x12.7 (6x1-5/8x1/2)	
Grade, MPa (ksi)	230 (33)		340 (50)		340 (50)	
Interior studs						
Thickness, mm (in)	1.09 (0.043)		1.09 (0.043)		1.09 (0.043)	
Dimensions, mm (in)	92x41x12.7 (3-5/8x1-5/8-1/2)		152x41x12.7 (6x1-5/8-1/2)		152x41x12.7 (6x1-5/8-1/2)	
Grade, MPa (ksi)	230 (33)		230 (33)		230 (33)	
Tracks						
	b	c	b	c	b	c
Thickness, mm (in)	1.09 (0.043)	1.37 (0.054)	1.37 (0.054)	1.73 (0.068)	1.73 (0.068)	2.46 (0.097)
Dimensions, mm (in)	92x31.8 (3-5/8x1-1/4)	92x31.8 (3-5/8x1-1/4)	152x31.8 (6x1-1/4)	152x31.8 (6x1-1/4)	152x31.8 (6x1-1/4)	152x31.8 (6x1-1/4)
Grade, MPa (ksi)	230 (33)	340 (50)	340 (50)	340 (50)	340 (50)	340 (50)
Gusset plates						
Thickness, mm (in)	NA		1.37 (0.054)		1.73 (0.068)	
Dimensions, mm (in)	NA		152x152 (6x6)		203x203 (8x8)	
Grade, MPa (ksi)	NA		340 (50)		340 (50)	

^aNominal dimensions and material properties

^bExtended Track

^cRegular Track

The testing frame (Figure 2.1) was equipped with a 250kN (55kip) hydraulic actuator with a stroke of $\pm 125\text{mm}$ ($\pm 5''$). The monotonic and cyclic tests were all

displacement controlled. The data recorded during the tests consisted of wall top displacement from the actuator's internal LVDT as well as a cable-extension transducer connected directly to the wall top. Four other LVDTs were used to measure slip and uplift of the wall relative to the frame in the bottom north and south corners. Three strain gauges per strap (one side of wall only) were used to evaluate the yielding status of the straps during testing. A load cell placed in line with the actuator was used to measure the in-plane lateral resistance of the test walls. Load cells were also installed on the bottom north and south anchor rods to measure uplift forces. These load cells were not included for the heavy walls because the uplift forces were expected to exceed the capacity of the load cells. During cyclic testing an accelerometer was used to directly measure accelerations at the top of the wall. Two Vishay Model 5100B scanners were used to record data to the Vishay Systems 5000 StrainSmart software. For all monotonic tests the data was monitored at 50 scans per second and recorded at 1 scan per second. For the cyclic tests data was both monitored and recorded at 100 scans per second.

2.2. Capacity Design Approach

The design of all test specimens followed a capacity design approach as required by AISI S213. The objective of this approach was to select a fuse element in the SFRS and use the probable capacity of that element to design the remaining components of the SFRS. This fuse element was chosen to dissipate the energy imparted to the specimen due to seismic loading while still allowing the wall to support gravity loads. In order to achieve this, the strap brace was selected as the fuse element; it was expected to yield in tension under repeated inelastic

displacement cycles. This section describes the assumptions and calculations which were used to design the wall test specimens.

Three lateral load levels were selected to represent a range of possible walls that would typically be constructed. In order to be consistent with previous research, these factored loads were assumed to be 20kN (light), 40kN (medium) and 75kN (heavy). In regular design situations these loads would be calculated using the lateral load provisions (wind or seismic) provided in the building code. Given the prescribed lateral load levels and a 2440 x 2440mm wall, the brace sizes were chosen based on their factored tension capacity shown in Equations 2-1 and 2-2 (CSA S136, 2007). Net section fracture was checked for all specimens assuming a weld pattern for the connection. Note: this same brace size was also used for the shorter 1220 and 610mm long walls even though it would not have provided the same lateral load resistance due to the change in angle of the straps.

$$T_r = \phi_t A_g F_y \quad (2-1)$$

where,

ϕ_t = tensile resistance factor (0.9)

A_g = gross cross section area

F_y = material yield strength

$$T_r = \phi_u A_n F_u \quad (2-2)$$

where,

ϕ_u = ultimate resistance factor (0.75)

A_n = net cross section area

F_u = material ultimate strength

Once the strap size was chosen the probable strap tension force, T_n , was calculated using Equation 2-3. The first step in the capacity design process was to ensure that fracture of the brace at its end connections would not occur (Equation 2-4).

$$T_n = A_g R_y F_y \quad (2-3)$$

$$A_n R_t F_u \geq A_g R_y F_y \quad (2-4)$$

where R_y and R_t are taken as 1.5 and 1.2 respectively for 230MPa (33ksi) steels and 1.1 and 1.1 for 340MPa (50ksi) steels (*ASTM A653, 2002, AISI S213, 2007*).

The net section area, A_n , was taken to be equal to the gross cross section area, A_g , despite the fact that additional holes (screws through straps at interior stud locations) were present. For the purposes of this testing, the additional holes were thought of as construction flaws and not something a designer would take into account.

Due to the high slenderness of the strap braces it was assumed that they were not capable of developing a compression resistance. The probable tension force, T_n , and its associated vertical and horizontal components (Table 2.2), were used in the design of the brace connections, chord studs, track, gusset plates, anchor rods, holddowns and shear anchors.

The chord studs were designed for the vertical component of the probable brace force in accordance with CSA S136 (2007) assuming concentric loading. The

back-to-back C shapes were considered to have unbraced lengths of 2440mm in the strong axis and 1220mm in the weak axis due to the intermediate bridging used in each specimen. The web knock out holes as well as the fastener screw spacing were considered in the design. It has been shown by Hikita (2006) that for unsheathed back-to-back chord studs using a pin-pin end condition ($k=1.0$) is conservative. Chord stud tests by Hikita indicated that $k= 0.9$ is reasonable and therefore this was used for the calculations; $k = 1.0$ may be more appropriate in practice, however. The nominal axial compression capacity ($\phi_c=1.0$) was used because the probable strap force would likely only be reached during the design level earthquake which has a return period of approximately 1 in 2500 years (Table 2.3).

Table 2.2: Probable forces in SFRS due to brace yielding

Force	Test Specimens ^a						
	Light		Medium		Heavy		
	2440×2440 (1:1)	1220×2440 (1:2)	2440×2440 (1:1)	610×2440 (1:4)	2440×2440 (1:1)	1220×2440 (1:2)	610×2440 (1:4)
	13A-M 14A-C 15A-M 16A-C	15B-M 16B-C	17A-M 18A-C 19A-M 20A-C	19B-M 20B-C	21A-M 22A-C 23A-M 24A-C	23B-M 24B-C	23C-M 23C-C
$A_x R_y F_y$ Single Brace (kN)	23.9	23.9	35.8	35.8	65.7	65.7	65.7
Total Horizontal Force (kN) ^b	33.8	21.4	50.6	17.4	93.0	58.8	31.9
Total Vertical Force (kN) ^a	33.8	42.8	50.6	69.5	93.0	117.5	127.5

^aAspect ratio given in brackets

^bTotal force based on probable capacity of two tension braces

The track resistance was determined using a similar approach to the stud capacity, however two configurations were investigated; the extended track as per Al-Kharat & Rogers (2008) and a regular track (Figure 2.2). The extended track

section allows the horizontal component of the brace force to be transferred to the supporting foundation through tension. In comparison, the regular track relies on its compression resistance to transfer the brace force to the shear anchors. To account for the lower compression resistance compared with the tension capacity different track sections (Table 2.1) have been selected for the extended and regular track configurations even though they were designed for the same lateral load and track force (Table 2.2). The unbraced length of the track in compression was taken as the distance from the edge of the wall to the first shear anchor. Shear anchors were spaced at approximately the same intervals along the top and bottom of each wall.

Table 2.3: Nominal axial compression capacity of back-to-back chord studs

Calculation assumptions	Test specimens						
	Light		Medium		Heavy		
	1:1	2:1	1:1	4:1	1:1	2:1	4:1
	13A-M 14A-C 15A-M 16A-C	15B-M 16B-C	17A-M 18A-C 19A-M 20A-C	19B-M 20B-C	21A-M 22A-C 23A-M 24A-C	23B-M 24B-C	23C-M 23C-C
Full composite action & web holes not considered (kN)	68.2		121.0		163.3		
Full composite action & 36 mm web holes considered (kN)	59.6		105.6		140.0		
Web connections at 300 mm o/c & web holes not considered (kN)	67.1		118.0		159.2		
Web connections at 300 mm o/c & 36 mm web holes considered (kN)	58.7		102.8		136.3		

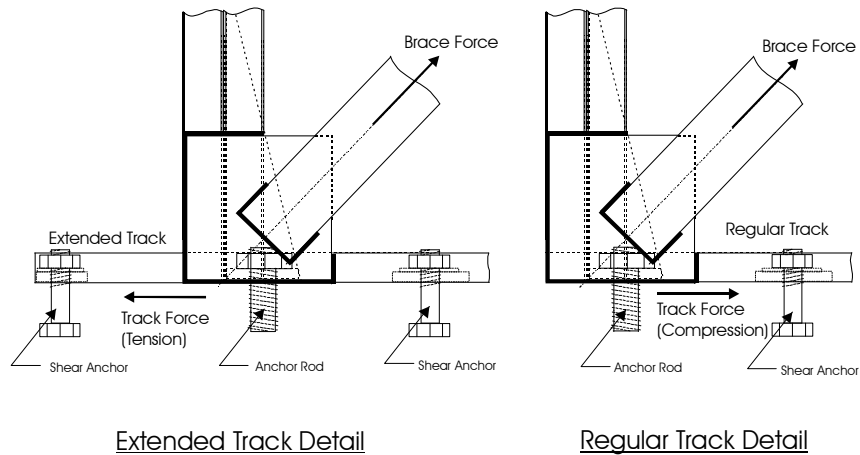

Figure 2.2: Extended and regular track detail showing track force

Bearing was also checked for all tracks. In the case of extended tracks, if the bearing capacity of a single external shear anchor was not adequate, another was added (heavy walls). The nominal track compression, tension and bearing capacities calculated in accordance with CSA S136 are shown in Table 2.4.

Table 2.4: Nominal track compression, tension and bearing capacities

Calculation assumptions	Test specimens					
	Light		Medium		Heavy	
	13A-M 14A-C	15A-M 16A-C 15B-M 16B-C	17A-M 18A-C 19B-M 20B-C	19A-M 20A-C	21A-M 22A-C 23B-M 24B-C 23C-M 23C-C	23A-M 24A-C
Compression capacity, web holes not considered (kN)	21.8	40.5	41.4	63.0	63.0	111.6
Tension capacity - gross section yielding, web hole not considered (kN)	37.9	69.9	98.0	122.8	122.8	172.1
Tension capacity - net section fracture, 22.2 mm hole for shear anchor considered (kN)	43.5	78.8	116.0	145.3	145.3	203.2
^a Bearing Capacity at shear anchor hole, bolt hole deformation not considered (kN)	14.5	30.6	30.6	43.1	43.1	63.4
^a Bearing Capacity at shear anchor hole, bolt hole deformation considered (kN)	11.2	21.0	21.0	27.7	27.7	41.9

^aBearing capacity based on one shear anchor

Once the chord stud and track members were selected for each specimen the welds and gusset plates at brace ends were designed. The weld groups were sized using their factored shear resistance (CSA S136) because an additional factor of safety against weld failure was desired. It was also necessary to satisfy Equation 2-4 regarding possible failure through the net section of the braces. In both cases the probable brace force was used as the applied load (Table 2.2).

The light walls had no gusset plates and the straps were welded directly to the chord stud and track. The weld pattern included two elements at an angle to the applied load (Figure 2.11). A transverse weld equal to the strap width was used in order to size the longitudinal welds because CSA S136 does not account for welds loaded at an angle. This resulted in a conservative weld group design due to the longer weld that was actually fabricated. Gusset plates were used with the medium and heavy walls. The straps were welded to the gusset plates, which were welded to the chord stud and track. The capacity of a transverse strap weld was first determined using a weld length equal to the strap width. Additional resistance was developed by specifying two longitudinal welds which ran along each edge of the strap, parallel to the loading direction. The resistances of these weld groups are provided in Table 2.5. The standard for hot rolled steel design, CSA S16 (2005), imposes a minimum weld length of 40mm, which was applied for both the medium and heavy walls. The S136 calculated weld resistance values and the increased (40mm longitudinal weld length) values are presented in the table. Walls with different aspect ratios used the same design procedure and therefore

had the same weld groups. Note: see Section 2.4.2 for information on the final weld group detail used on the heavy walls.

Table 2.5: Strap weld design lengths and capacities

Calculation Assumptions ^a		Test Specimens						
		Light		Medium		Heavy		
		1:1	1:2	1:1	1:4	1:1	1:2	1:4
		13A-M 14A-C 15A-M 16A-C	15B-M 16B-C	17A-M 18A-C 19A-M 20A-C	19B-M 20B-C	21A-M 22A-C 23A-M 24A-C	23B-M 24B-C	23C-M 23C-C
Transverse Weld Length (mm)		- ^b		70		102		
CSA S136	Longitudinal Weld Length, x 2 welds (mm)	55		20		28		
	Total design fillet weld length (mm)	173		110		158		
	Weld Group Capacity (kN)	24.0		36.4		65.7		
CSA S136 (40mm minimum weld length)	Longitudinal Weld Length, x 2 welds (mm)	-		40		40		
	Total design fillet weld length (mm)	-		150		182		
	Weld Group Capacity (kN)	-		40.7		71.4		

^aWeld capacity calculations based on 3mm fillet weld and an electrode strength $F_{xx} = 410$ MPa

^bNo transverse welds used on light walls (see Figure 2.11)

Once the longitudinal weld lengths were determined the gusset plate could be sized using the Whitmore (1952) section technique to ensure yielding of the strap braces would occur. To determine the Whitmore section length (L_{wm}), a line was taken at 30° from the leading edge of the connection as shown in Figure 2.3. L_{wm} is the length of the line which is extended parallel to the back edge of the connection intersecting the 30° lines. Equations 2-5 and 2-6 from CSA S136 (nominal values as per capacity design) were then used to calculate the tension resistance of the gusset plate (Table 2.6).

$$T_n = (L_{wm} t) F_y \quad (2-5)$$

$$T_n = (L_{wm} t) F_u \quad (2-6)$$

The nominal tension resistance of the gusset plates was required to exceed the probable brace force, therefore L_{wm} was used to find the minimum gusset plate size (Figure 2.3). This gusset plate size was then examined for the different geometries of the 1:2 and 1:4 walls and one size was chosen for consistency through the range of aspect ratios within each lateral load group (medium and heavy).

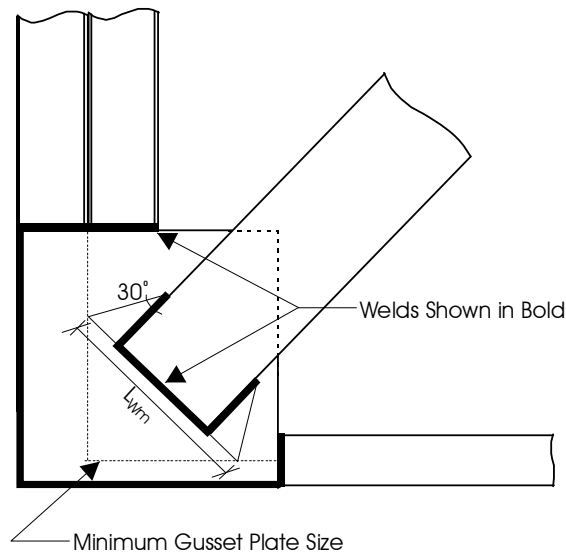

Figure 2.3: Whitmore section diagram

Table 2.6: Nominal gusset plate resistance based on Whitmore section calculation

Calculation assumptions ^a	Test specimens						
	Light		Medium		Heavy		
	1:1	1:2	1:1	1:4	1:1	1:2	1:4
	13A-M 14A-C 15A-M 16A-C	15B-M 16B-C	17A-M 18A-C 19A-M 20A-C	19B-M 20B-C	21A-M 22A-C 23A-M 24A-C	23B-M 24B-C	23C-M 23C-C
Gusset plate capacity based on Whitmore section calculation, gross section yielding (kN)	NA		54.1		83.3		
Gusset plate capacity based on Whitmore section calculation, net section fracture (kN)	NA		71.6		110.2		

^aValues based on 40mm longitudinal weld length

The welds between the gusset plate and chord studs/track were designed to resist the vertical and horizontal components of the probable strap force. It was assumed that the vertically oriented weld would resist the vertical force, while the horizontal weld would carry the horizontal force. The two welds were conservatively assumed to act independently. Furthermore, in all cases the gussets were welded around the perimeter, which resulted in significantly more weld than was required from the design calculations.

The Simpson Strong-Tie holddowns (Figure 2.4) selected for each wall have been specifically designed for use with back-to-back chord studs and were used in previous research projects at McGill University (*Al-Kharat & Rogers, 2008; Blais, 2006*). They were chosen to overcome the probable vertical force resulting from strap brace yielding. Initially, the manufacturer's allowable design values (*Simpson Strong-Tie Co., 2005*) were relied on to choose the holddown size. Model S/HD10S ($T_{\text{allowable}} = 49.5\text{kN}$, $T_{\text{ultimate}} = 182.9\text{kN}$) was chosen for the light walls and model S/HD15S ($T_{\text{allowable}} = 60.0\text{kN}$, $T_{\text{ultimate}} = 218.6\text{kN}$) was chosen for medium walls. Model S/HD15S was also used for the heavy walls and the 1:4 medium walls even though the allowable tension load given was not greater than the probable tension force. Since a larger holddown is not available, the listed ultimate capacity of the S/HD15S was used in comparison with the probable vertical brace force. The designer should verify this approach with the manufacturer when choosing holddowns. A holddown was installed on the interior of each corner in every test wall.

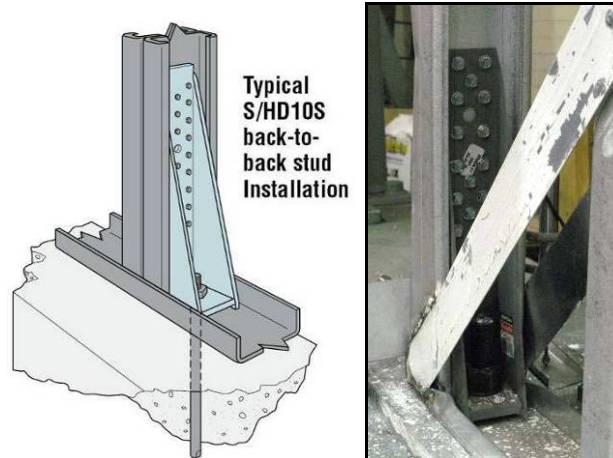

Figure 2.4: Example holddown fixture installed in back-to-back chord stud (Left: Simpson Strong-Tie Co., 2005)

As a final design check, the lateral in-plane deflection, based on the strap brace stiffness alone, assuming pin-pin connections and including the AISI S213 $R_d R_o = 2.6$, was checked and found to be well within the inter-storey inelastic drift limit of 2.5% given the factored load level used in design (NRCC, 2005a). Service level drift limits were not considered in the design of the test walls.

2.3. Development of Welding Protocol

2.3.1. Welding Procedure

Welding of zinc coated CFS sections requires precise settings and control. If too high of a current is used the thin sections will melt leaving holes in the specimen and if the current is too low, inadequate penetration will result in a poor quality, low strength weld. It is also necessary to use an electrode designed to be effective despite the impurities which are present due to the zinc coating. The gas metal arc welding (GMAW) process, commonly known as MIG welding, was used. In this process the quality of weld depends on shield gas mixture, type of electrode, and

current and wire feed settings. The current was controlled by adjusting the output voltage on the welding machine.

To facilitate spray transfer of the molten electrode, which creates a smooth finished weld profile and good penetration with minimal splatter (*Canadian Welding Bureau, 2005*) an inert gas mixture high in argon was used (75% Ar / 25% CO₂). This gas mixture is also recommended by the chosen wire electrode manufacturer (*Cronatron Welding Systems Inc., 2003*) for use when welding thin metals. Cronamig 321M 0.030” diameter welding electrode wire was used; it is designed for use with thin metals and is not affected by coated steels. The power source, a Lincoln Electric Wire-Matic 255 GMAW welder, was set to a wire feed of 150 in/min and an output voltage of 19V. After numerous trials (Section 2.3.2) these settings were decided upon as they gave a clean arc and good weld penetration without burning through the thin steel members. Example weld photographs are shown in Figure 2.5 and Figure 2.6.



Figure 2.5: Welding setup and Lincoln Electric GMAW welder



Figure 2.6: Welding process and partially finished weld pattern on a medium wall

2.3.2. *Weld Testing*

Prior to the fabrication of any walls, sample strap connections were welded and tested under direct tension (Figure 2.7) to ensure adequate weld quality and to validate the weld procedure. The failure mode for each sample fabricated using the final weld procedure was gross cross section yielding of the strap, followed by strain hardening and eventual strap fracture.

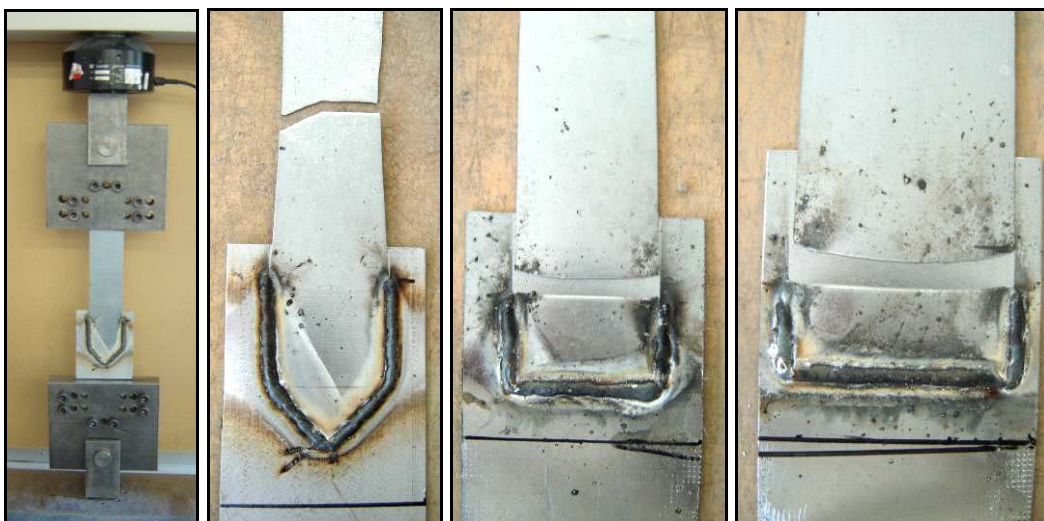

Figure 2.7: Welded strap sample undergoing tension test, failures for three strap sizes

In no case did the welds fail during these connection performance tests. The light strap fracture occurred well away from the weld group while the medium and heavy strap fractures occurred at the leading edge of the weld group. At the start and stop of a weld in sheet steel there is some undercutting which takes place and this is most likely the area of least cross section of the brace. For the chosen weld setup, no failures of or through the weld metal were observed.

The weld cross section of these samples was also examined visually, through grinding, polishing and etching of the surface. Adequate penetration and homogeneity of the weld and base metals were observed (Figure 2.8). Pictures a), b), c), and d) of the Figure show that different microstructure properties are present in the base metal, heat affected zone (HAZ) and the weld metal. These differences are due to the different properties of the base metal and welding electrode used. The photos show that good quality welds were achieved.

Given the satisfactory performance of the weld connection test specimens, along with this visual inspection, it was decided to use the same weld procedure in the fabrication of the wall test specimens.

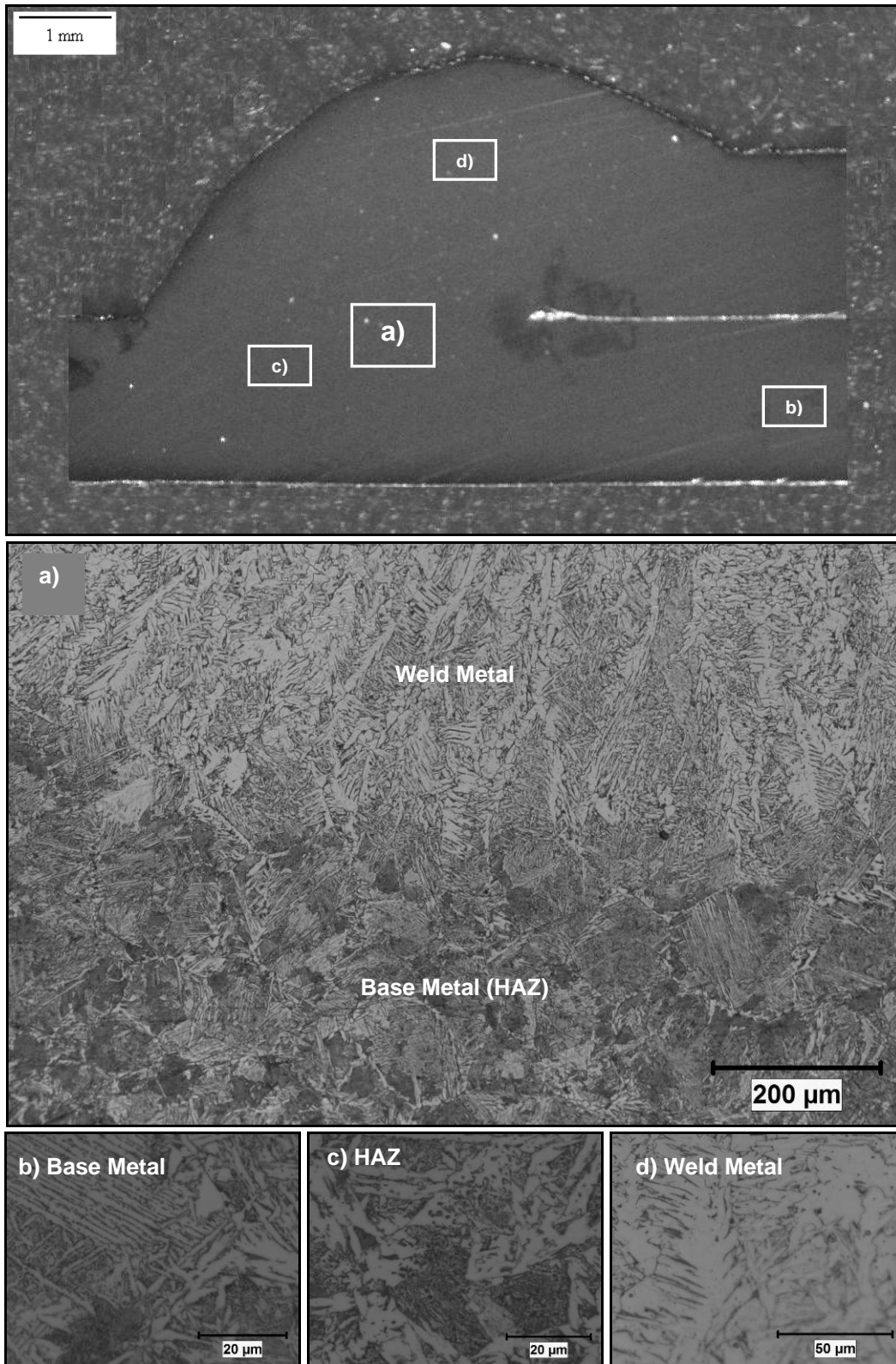

Figure 2.8: Polished cross section of weld connection between gusset plate and strap

2.4. Construction Details

2.4.1. *General Fabrication and Construction Details*

The test walls were fabricated in the Jamieson Structures Laboratory at McGill University. Top and bottom tracks were prepared to accept the appropriate number of shear anchors and holddowns. The location of these holes for the 2440 x 2440mm walls is shown in Figure 2.9. For the 2440 x 2440mm (8' x 8') wall specimens there were 10 shear anchors through the top track and six through the bottom track. The 1220 x 2440mm (4' x 8') wall specimens had four shear anchors through the top and bottom tracks while 610 x 2440mm (2' x 8') wall specimens had only one shear anchor through the top and bottom tracks. The walls with extended tracks had an additional two shear anchors in both the top and bottom tracks except in the case of heavy walls where four extra shear anchors were placed in the top and bottom tracks (Appendix A).

The chord studs were constructed with two back-to-back 'C' profiles fastened with two No. 10 x 3/4" (19mm) self drilling wafer head screws every 300mm (12") along their length. Simpson Strong-Tie holddowns, S/HD10S for light walls and S/HD15S for medium and heavy walls, were installed at the top and bottom of each chord stud with No. 14 x 1" (25mm) self drilling hex head screws (24 for the S/HD10S and 33 for the S/HD15S). Once the tracks and chord studs were prepared, walls were assembled on the floor using various clamping techniques to ensure a tight fit between members and consistency in construction (Figure 2.10).

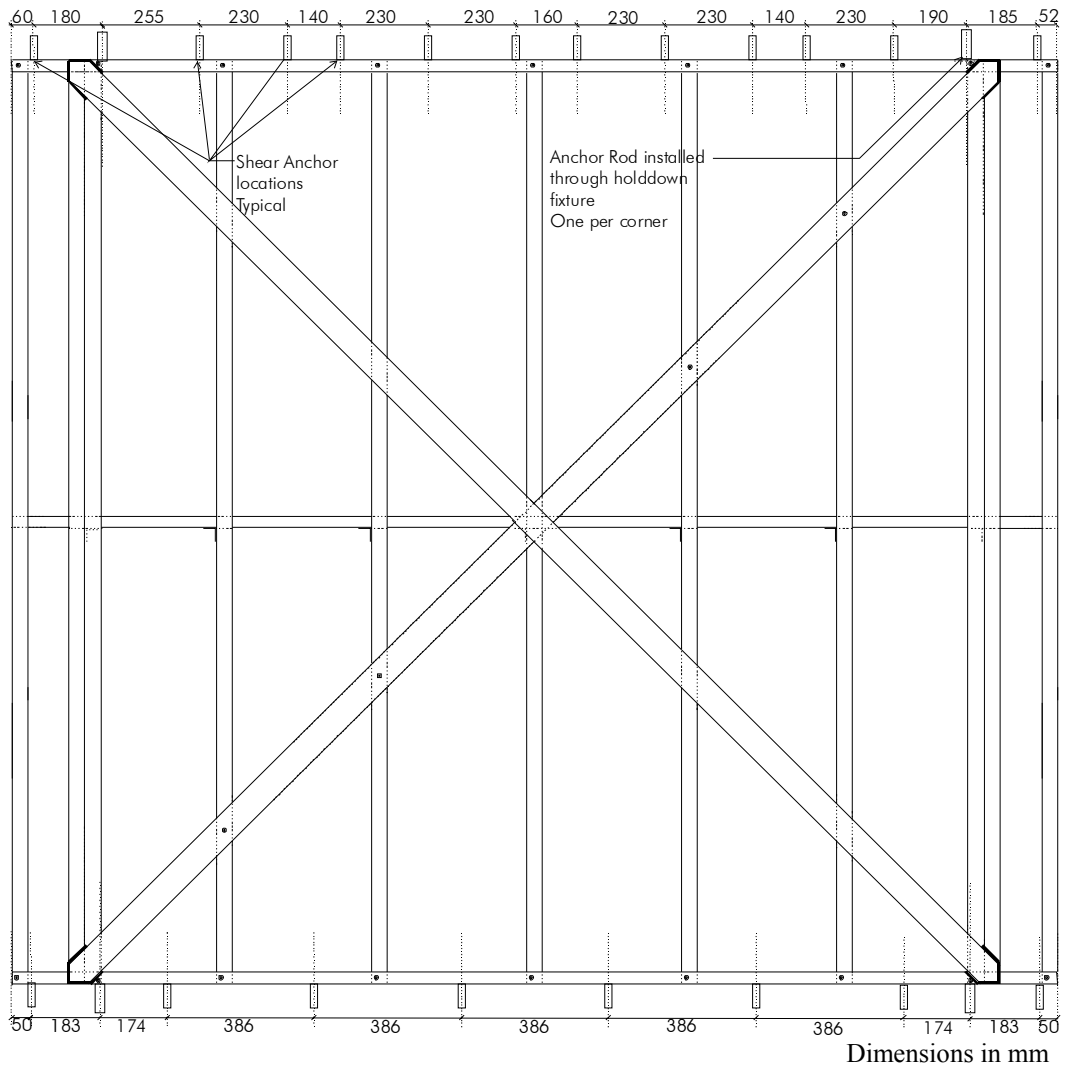

Figure 2.9: Shear anchor and anchor rod locations



Figure 2.10: Assembled walls in laboratory; final welding of gusset plates and straps

Interior studs were spaced at a nominal 406mm (16") on centre and connected to the tracks with one No. 8 x 1/2" (13mm) self drilling wafer head screw on each side of the wall. The same connection was made for the chord studs to the track to facilitate wall transportation to the welding area. Bridging was installed through the web knockouts in the studs at mid height of the wall. Bridging clips were then fastened to the stud and bridging using No. 8 x 1/2" (13mm) self drilling wafer head screws. The straps were cut to length from strips that had previously been sheared to the correct width by the steel supplier.

Once in the welding area, screws holding the chord studs to the tracks were removed and diagonal measurements were used to square the wall. Gusset plates, 152 x 152mm (6" x 6") for medium walls and 203 x 203mm (8" x 8") for heavy walls, were first welded in place, and then the straps were welded to the gusset plates (Figure 2.10). In the case of light walls (no gusset plates), the straps were positioned and welded into place. Weld patterns were similar for walls within each of the three configurations regardless of whether the extended or regular track detail was used (Figure 2.11). The location and angle of the strap connection weld group changed for walls with aspect ratios other than 1:1, which can be seen in the corner diagrams in Appendix A. In all cases, the line of action of the strap intersected with the centreline of the chord stud at the edge of the wall; similar weld lengths were used and the Whitmore section length was maintained.

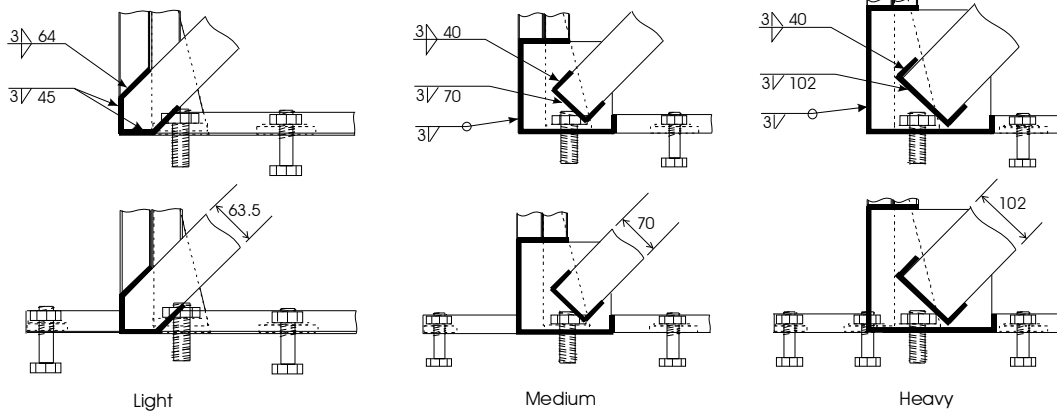

Figure 2.11: Corner details for 2440 x 2440mm light, medium and heavy walls

After welding, the specimens were moved back to the assembly area for instrumentation and installation into the test frame. Diagrams containing construction details for all walls, similar to Figure 2.12, are given in Appendix B.

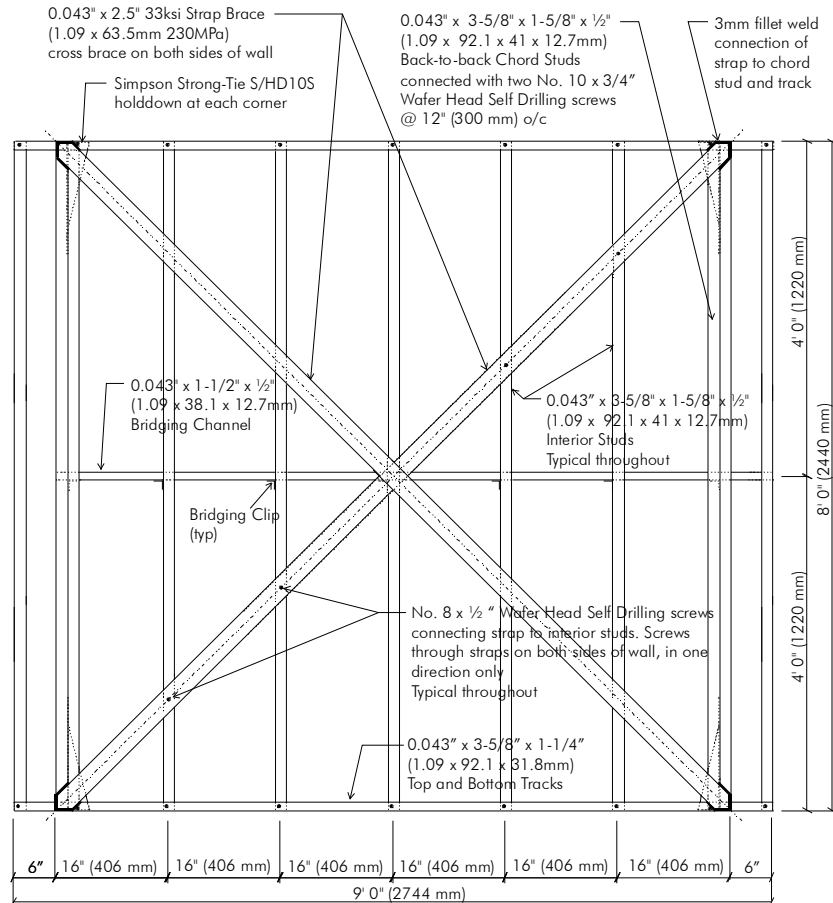

Figure 2.12: Nominal dimensions and specifications of light walls 13A-M and 14A-C

2.4.2. *Heavy Wall Weld Connection Details*

During a preliminary test of heavy wall 21A-M, the first wall of this size that was tested, a base metal weld failure occurred after yielding of the braces (Figure 2.13). This type of failure was not observed in the connection tests (Section 2.3.2) nor in any light or medium walls. The transverse weld connection initially failed at a lateral drift of 5.6% and was followed by strap tearing along the longitudinal welds. The yield capacity of the braces had been reached and strain hardening had begun prior to the connection failure. This failure happened on both sides of the wall at approximately the same displacement (Figure 2.13, right side, top and bottom).



Figure 2.13: Connection failure of preliminary test 21A-M

Adequate overlap of the weld metal onto the strap, and therefore melting of the strap within the weld pool, was not provided during fabrication and is thought to

be the cause of failure. Even though adequate weld performance was seen with the strap sample welds (Section 2.3.2), it was decided to retest specimen 21A-M with an increased longitudinal weld length of 90mm (the results presented reflect this retest) to account for the possible shortcoming in fabrication of the transverse weld. This increase in weld length resulted in a factored weld group capacity of 89.5kN and was used on all heavy wall tests. A strap sample weld test of the new weld group was run; no significant change in weld group stiffness or capacity was observed compared with the original weld design for the heavy walls (Figure 2.11).

2.5. Test Instrumentation and Installation

Prior to testing each wall specimen was instrumented and installed in the test frame. Measurements of the width of each brace were taken. Strain gauges were installed on one side of the wall only. Three gauges per strap were used to identify whether yielding along the length of the brace had occurred. The locations of strain gauges can be seen in Appendix C. The straps running from the bottom north corner to the top south corner of all walls were fastened to each interior stud with one No. 8 x ½” (13mm) screw. The straps running in the opposite direction contained no additional screw fasteners. Small steel plates were installed at the bottom north and south corners to serve as a contact point for the LVDT measurements of slip and uplift. Another plate was attached to the wall at the top south corner to attach the steel piano wire which served as an extension leading to the cable-extension transducer, for direct measurement of wall displacement. The locations of the LVDTs and the cable-extension transducer are shown in Figure

2.14. All straps and gusset plates were painted with a hydrated lime / calcium hydroxide solution to allow yielding progress to be visible during testing.

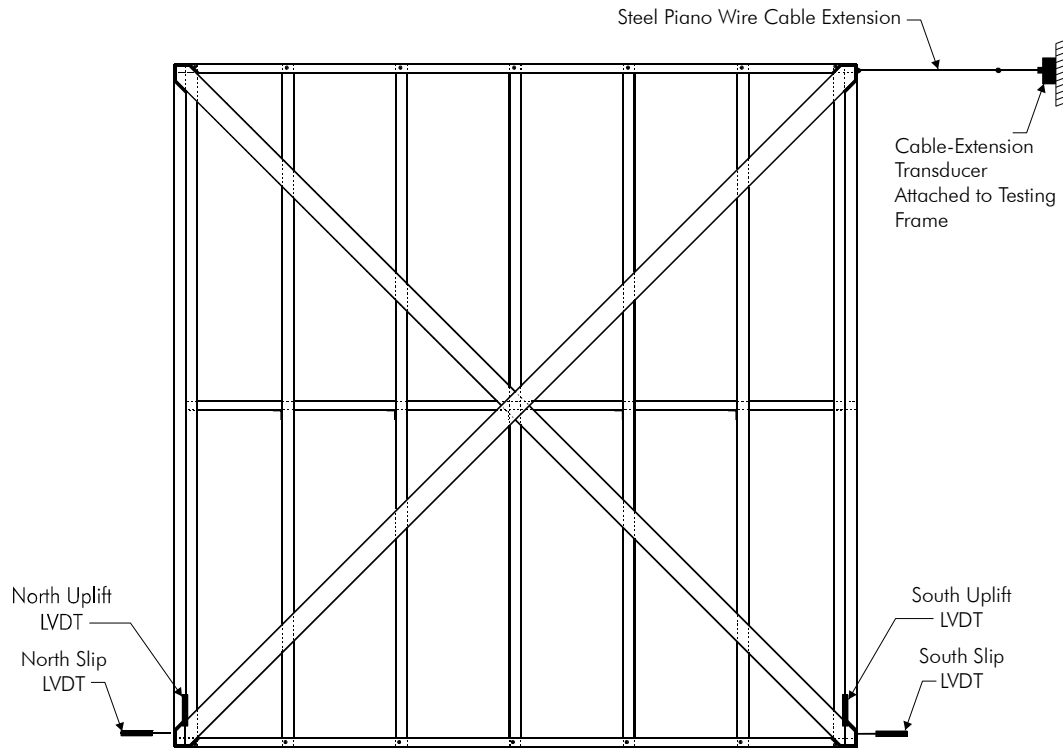

Figure 2.14: Positioning of LVDTs and cable-extension transducer

Once placed into the test frame, walls were aligned and the appropriate number, depending on wall length, of 3/4" (19.1mm) diameter ASTM A325 (2002) shear anchor bolts, was installed. The anchor rods (ASTM A193 B7 (2006) 7/8" (22.2mm) (light walls) and 1" (25.4mm) (medium and heavy walls) diameter threaded rod) were then installed and all shear anchor bolts were tightened. The bottom north and south anchor rods were instrumented with load cells which were used to monitor holddown force during testing and to ensure that similar tension ($\approx 10\text{kN}$) was applied to each during installation.

2.6. Monotonic Load Protocol

All test specimens with 'M' as the last letter in their name were designated as monotonic (static pushover) tests. These displacement controlled tests were run at a rate of 2.5 mm/min. The in plane displacement of the top of the wall and the applied lateral load were monitored. Most tests were run until the displacement limit of the actuator, approximately 220mm (9% drift), was reached with no drop in load. A typical lateral load versus deflection curve is shown in Figure 2.15. In the case where failure of an element in the SFRS occurred prior to the 9% drift level being reached the test was stopped.

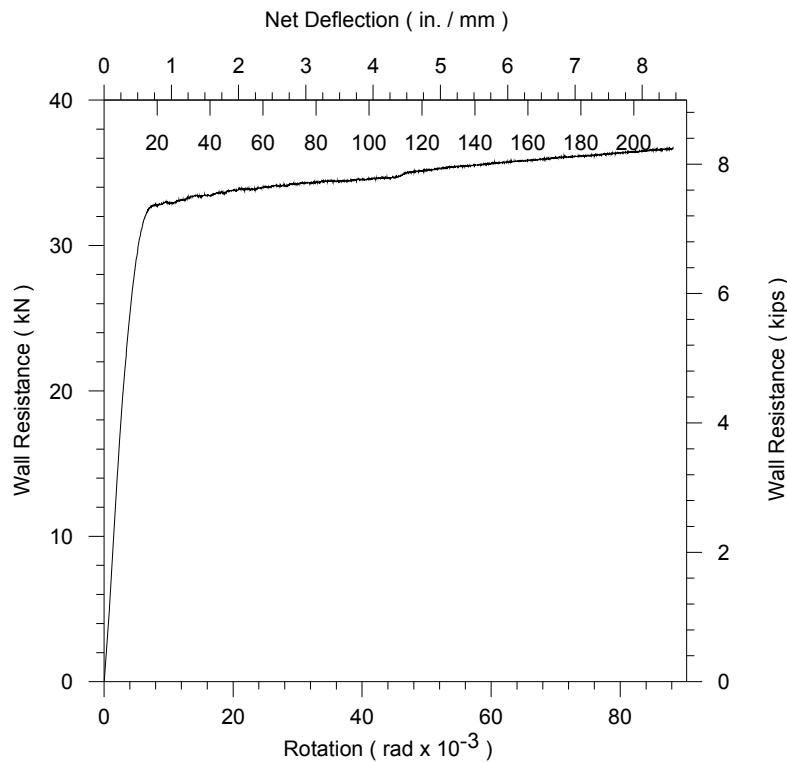

Figure 2.15: Typical lateral resistance versus wall top deflection for a monotonic test

2.7. Reversed Cyclic Load Protocol

The Consortium of Universities for Research in Earthquake Engineering (CUREE) ordinary ground motions reversed cyclic load protocol (*Krawinkler et al., 2000*) was chosen for the cyclic testing of the strap braced walls. This is a similar procedure to that covered by ASTM E2126 (2005) for the testing of light framed walls containing solid sheathing or metal framing with braces. This protocol is primarily concerned with evaluating the lateral in-plane capacity of wood sheathed shear walls; it was assumed that since a strap braced wall and sheathed wall can be used interchangeably that the CUREE protocol could be used. Furthermore, in previous research done on similar strap braced walls and wood sheathed walls at McGill University, this protocol was used (*Branston et al., 2006; Al-Kharat & Rogers, 2007, 2008*).

The CUREE protocol was developed to cover a wide variety of ordinary ground motions with a probability of exceedance of 10% in 50 years. It is a real possibility that a structure will undergo more than one of these events in its lifetime; this is taken into account in the protocol.

The cycles in the protocol are joined together with a sine function. Their amplitude is a percentage of a reference displacement which was based on the results of the nominally identical monotonic tests. Usually the deflection at 80% post peak load is used to obtain the reference deflection; however, since in most cases no drop in load was recorded the reference deflection was taken as 2.667

times the yield load (ΔS_y on Figure 2.18). This is consistent with the approach used by Al-Kharat & Rogers (2007, 2008); it also ensures that a reasonable number of inelastic cycles (approx. 6–7) are applied to the specimen prior to the 4.5% drift level (testing apparatus limit) being reached (Figure 2.16). A typical amplitude versus time plot showing the initiation, primary and trailing cycles which make up a complete protocol is shown in Figure 2.17.

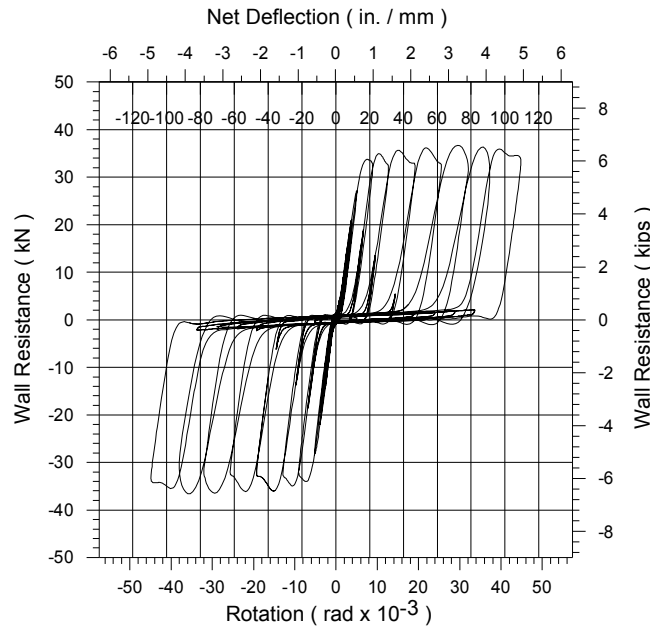

Figure 2.16: Typical lateral resistance versus wall top deflection for a reversed cyclic test

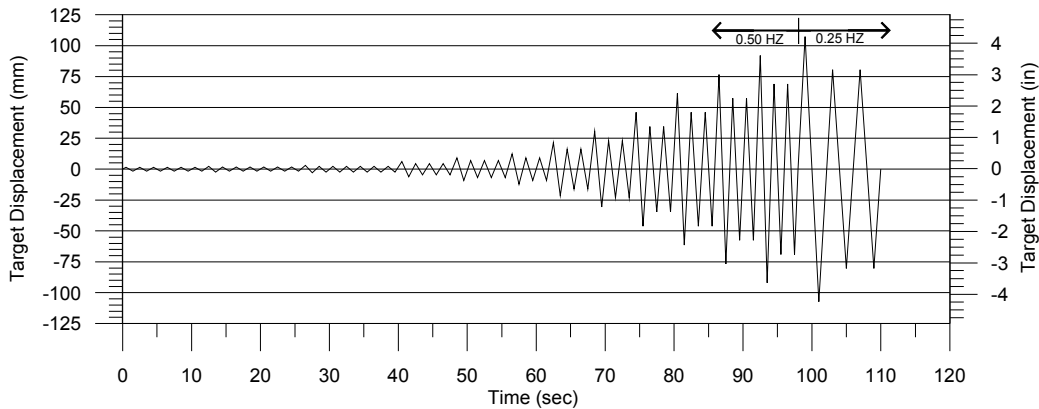

Figure 2.17: Typical reversed cyclic test protocol

For all tests the frequency of the protocol was kept at 0.5 Hz, except when the cycle amplitude was over 100mm where the frequency was reduced to 0.25 Hz. The lower frequency was used to ensure that the actuator would have an adequate oil supply during higher amplitude cycles. These frequencies are within the range described in ASTM E2126 (2005). The lateral load versus wall top deflection curve for specimen 14A-C is shown in Figure 2.16 as an example of the cyclic loading test result. The cyclic amplitudes and protocols are shown in Appendix D both as tables and figures for each cyclic test. Note: since a reversed cyclic protocol was used the maximum displacement that could be reached (4.5% storey drift) was half of that used during the monotonic tests (9% storey drift).

2.8. Analysis of Measured Test Data

2.8.1. *Lateral Wall Resistance*

The measured and predicted wall resistance parameters, S_{max} , S_y , $S_{0.80}$, S_{yp} , S_{yn} and $S_{0.40}$ were obtained for each monotonic (Figure 2.18) and cyclic (Figure 2.19) test. S_{max} was defined as the maximum resistance recorded during testing for monotonic and cyclic tests. The lateral resistance at yield, S_y , was chosen as the lowest value in the post yield plateau for monotonic tests. The cyclic tests do not show any post yield plateau due to strain rate and strain hardening effects, therefore S_y was taken as S_{max} , the highest load observed on any hysteretic loop. It is important to note that any subsequent comparisons of predicted and measured S_y values will be affected by the different definition of this variable for the two

test protocols. $S_{0.80}$ (post peak) and $S_{0.40}$ were defined as 80% and 40%, respectively, of S_{max} .

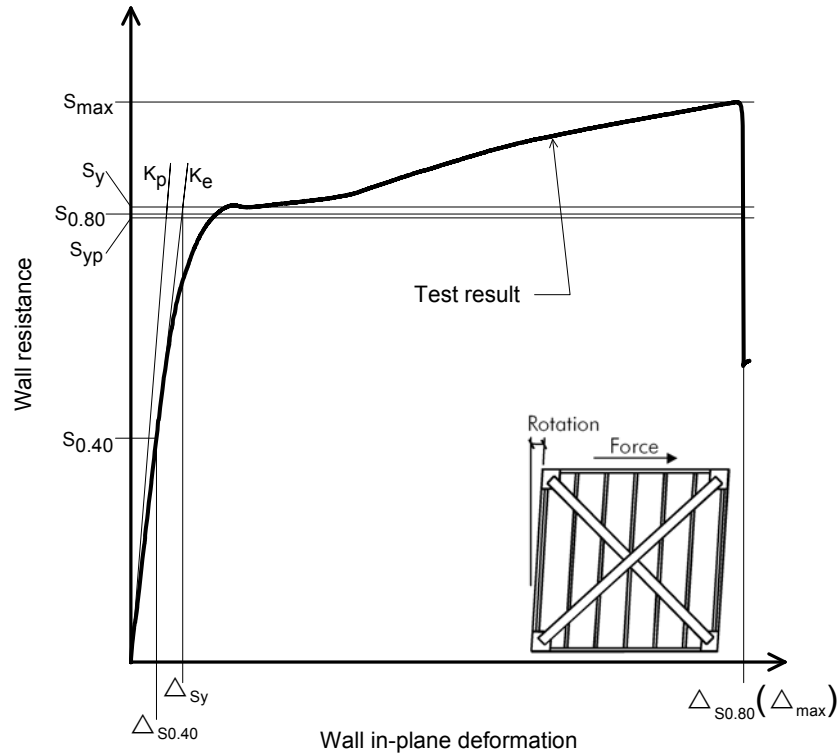

Figure 2.18: Definition of measured and predicted properties for monotonic tests

The resistance of the wall, S , as measured by the load cell was adjusted to remove load due to inertial effects caused by accelerations during reversed cyclic testing. The mass of the wall, loading beam and connections was taken into account along with the measured lateral acceleration at the top of the wall. The corrected applied load, represented by S' , is presented in Equation 2-7.

$$S' = S \pm \left(\frac{a \times g \times m}{1000} \right) \quad (2-7)$$

where,

S' = corrected shear wall resistance (kN)

S = measured shear wall resistance (kN)

a = measured acceleration of the top of the wall (g) (m/s^2)

g = acceleration due to gravity ($9.81 m/s^2$)

m = mass [250 kg for the loading beam + half the mass of the steel wall (60, 90, 110 kg for the light, medium and heavy strap walls respectively)]

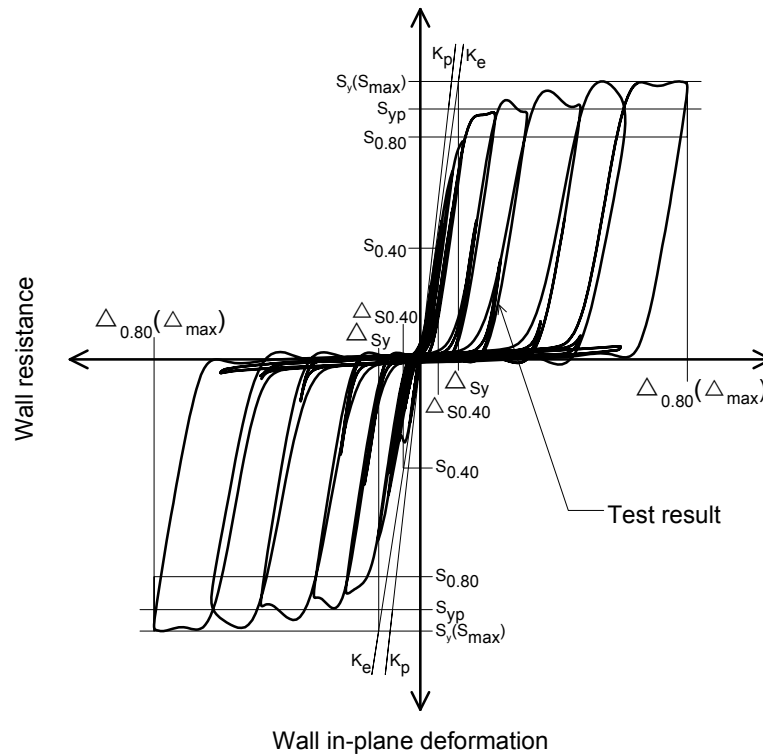

Figure 2.19: Definition of measured and predicted properties for cyclic tests

The calculation of S_{yp} , the predicted yield resistance (Equation 2-8) used the results obtained from material properties testing (Section 2.9) along with the measured strap dimensions.

$$S_{yp} = \frac{2 \cdot F_y \cdot t_{avg} \cdot W_{avg}}{1000} \cos(\alpha) \quad (2-8)$$

where,

F_y = brace material yield strength from coupon testing (MPa) (Section 2.9)

t_{avg} = base metal thickness from coupon testing (mm) (Section 2.9)

W_{avg} = average strap width, mm (Appendix E)

α = angle of strap brace from horizontal

In the calculation of S_{yp} the yield strength, F_y , was based on the lowest strain rate coupon test results for the monotonic walls and the highest strain rate coupon test results for the cyclic walls (Section 2.9). A nominal predicted yield resistance, S_{yn} , was also calculated for each specimen using the same method as S_{yp} (Equation 2-8), with nominal properties for t_{avg} and W_{avg} and the minimum specified yield strength, F_y . Another nominal prediction, the capacity design yield load, S_{yc} , was calculated to compare with the test result yield load, S_y . This prediction includes the R_y factor which was used in capacity design and the properties used for S_{yn} . Appendix A contains the values of S_{max} , S_y , $S_{0.40}$, S_{yp} and S_{yn} for each test specimen. Section 2.11.1 contains a discussion of the measured and predicted resistances.

2.8.2. *Lateral Wall Stiffness*

The in-plane lateral wall stiffness, K_e , was measured to make a comparison with the predicted value, K_p (Figure 2.18 (monotonic), Figure 2.19 (cyclic)). In order to calculate K_e , the measured elastic lateral stiffness, a load level of 40% of the maximum load, $S_{0.40}$, and the corresponding deflection, $\Delta_{S_{0.40}}$, were used. It was assumed that the test specimen was still in the elastic range at this point. The 40% load level is consistent with previous research on shear walls (*Branston et al., 2006; Al-Kharat & Rogers, 2006*) and is used in ASTM E2126. The elastic stiffness was then calculated using Equation 2-9.

$$K_e = \frac{S_{0.40}}{\Delta_{S0.40}} \quad (2-9)$$

Before each test was run the strap widths were measured and recorded. These measurements, along with the yield strength and base metal thickness from the coupon tests were used to calculate the brace component, K_B , of the predicted stiffness, K_p . The stiffness of the strap braces, K_B , holddown, K_{HD} , and anchor rod, K_{AR} (Equations 2-11, 2-12, 2-13 respectively), were deemed to contribute significantly to the lateral stiffness of the system and were therefore taken into account (Equation 2-10, Figure 2.20). The anchor rod and holddown stiffness equations were derived by assuming rigid body motion of the wall about the bottom compression corner.

$$\frac{1}{K_p} = \frac{1}{2 \times K_B} + \frac{1}{K_{HD}} + \frac{1}{K_{AR}} \quad (2-10)$$

where,

$$K_B = \frac{a \times E}{l} \times \cos^2 \alpha \quad (2-11)$$

$$K_{HD} = \frac{K_{ms}}{\tan^2 \alpha} \quad (2-12)$$

$$K_{AR} = \frac{E \times A_{AR}}{l_{AR} \times \tan^2 \alpha} \quad (2-13)$$

where,

a = measured gross cross-section area of one strap

E = Young's modulus (203000MPa)

l = length of one strap (exterior wall dimensions used)

α = strap angle with respect to horizontal

K_{ms} = holddown stiffness given by manufacturer (*Simpson Strong-Tie Co., 2005*)

l_{AR} = length of the anchor rod between its connecting nuts

A_{AR} = cross section area of the anchor rod, excluding the threads

The test results tables found in Appendix A also include K_n ; a nominal lateral stiffness. This was done using the same steps as the K_p calculation (Equations 2-10 to 2-13), except that the nominal strap area was used. Section 2.11.2 contains a discussion of the measured and predicted wall stiffness.

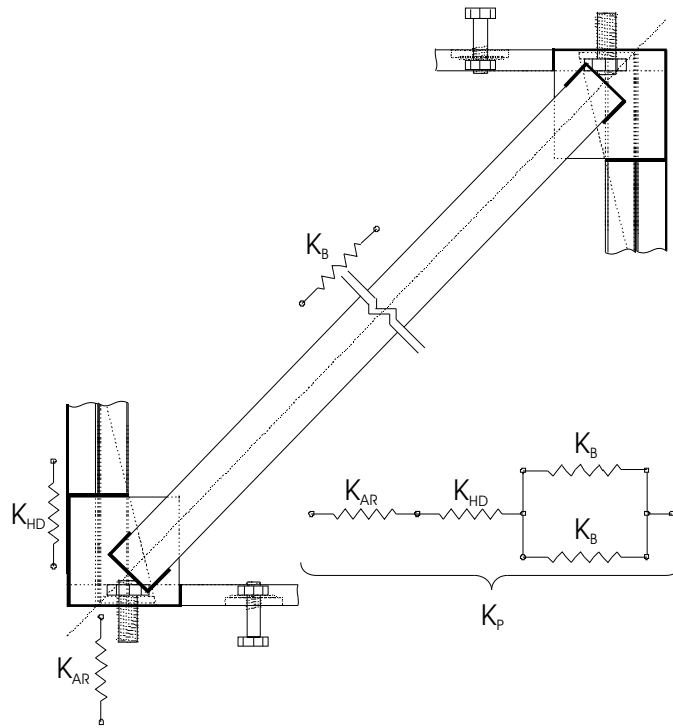

Figure 2.20: Components contributing to predicted stiffness, K_p

Note: direct tension tests on the strap material alone were also carried out (separate from the coupon testing, Section 2.9) to compare with the weld section stiffness (Section 2.3.2). It was determined that there is a negligible difference between the strap axial stiffness with and without the weld connection. For this

reason the stiffness of the weld connection was not included in the overall wall stiffness calculation. Furthermore, the axial stiffness of the chord studs was also not considered in the calculation of K_p . The strap widths used for the cross-section area calculation in Equation 2-11 are shown on the test data sheets in Appendix E and the thickness values are from the coupon test results.

2.8.3. Seismic Force Modification Factors

The test-based seismic force modification factors for use with the NBCC were calculated following a method similar to that described by Mitchell et al. (2003) and that utilized for wood sheathed / CFS frame shear walls by Boudreault et al. (2007). The ductility of the system, μ , was calculated using two reference displacements. First, the ideal elastic yield displacement was calculated by dividing the measured yield load, S_y , by the measured wall elastic stiffness, K_e , as shown in Equation 2-14 and Figure 2.18.

$$\Delta_{Sy} = \frac{S_y}{K_e} \quad (2-14)$$

Second, the reference displacement corresponding to the 80% post peak load level of the test specimen, $\Delta_{0.80}$, was determined as shown in Figure 2.18 (monotonic) and Figure 2.19 (cyclic). This point was chosen as the load level when the wall had reached the end of its useful load carrying capacity. For wall specimens that did not show a drop in load the maximum deflection they reached (testing apparatus limit) was chosen as a conservative number to estimate the ductility. This was always the case for cyclic tests as fracture of the strap braces was not observed. The ductility, μ , of the system is as shown in Equation 2-15.

$$\mu = \frac{\Delta_{0.80}}{\Delta_{Sy}} \quad (2-15)$$

Test-based force modification factors R_d and R_o were then determined. The ductility related force modification factor, R_d , was calculated using Equation 2-16 (*Newmark & Hall, 1982*).

$$R_d = \sqrt{2\mu - 1} \quad (2-16)$$

The overstrength factor, R_o was estimated by computing the product of R_y , for yield strength, R_{sh} , to account for strain hardening and the inverse of the resistance factor, $1/\phi$, as shown in Equations 2-17, 2-18 and 2-19.

$$R_y = \frac{S_y}{S_{yn}} \quad (2-17)$$

$$R_{sh} = \frac{S_{4\%}}{S_y} \quad (2-18)$$

$$R_o = \frac{R_y R_{sh}}{\phi} \quad (2-19)$$

R_{sh} was calculated for the monotonic tests based on the resistance measured at 4% drift divided by the yield resistance. R_{sh} was not utilized for the cyclic tests because the term R_y is a function of the measured yield resistance of the wall, S_y , which in this case already includes any strain hardening effects (Section 2.8.1). A resistance factor for gross cross section yielding in tension, $\phi = 0.9$, was used. The values for R_d and R_o are summarized in Section 2.11.

2.8.4. *Energy Calculations*

The energy absorbed by each wall, E, (area under the resistance deformation curve) (Equation 2-20) was calculated incrementally as the sum of the average energy for each time step during testing. The energy absorbed for each test specimen is presented in Section 2.11.4.

$$E = \sum_{n=1}^t \frac{(\Delta_{n-1} - \Delta_n) \cdot S'_n}{2} \quad (2-20)$$

where,

E = total absorbed energy (Joules)

S' = corrected shear wall resistance at time step (kN)

Δ = lateral displacement at time step (mm)

t = elapsed time of test (s)

2.9. **Material Properties**

Material tests were carried out for the straps, chords, tracks and gusset plates to determine their thickness, yield and ultimate strength (Table 2.7 and 2.8). Where members came from the same coil, only one set of tests was necessary. Coupon test specimens were prepared in the lab by cutting 230mm (9") x 19mm (3/4") samples and milling out a centre gauge length of 50mm (2") to ensure failure during testing away from the grips of the direct tension testing machine (*ASTM A370, 2002*). All tests except for the straps were conducted at a cross-head rate of 0.1mm/min in the elastic range, and increased to 6 mm/min once the test was beyond the yield point.

Nine coupons for each strap size were tested because the walls were designed with the strap as the fuse element. They were divided into groups of three; each of which was tested at a different cross-head rate. The rates were 0.1mm/min, 50mm/min and 100mm/min. These rates were chosen to best simulate the strain rates which the straps would undergo during a full wall test. The intent was to represent approximately the maximum brace strain rates of the monotonic ($0.000019s^{-1}$) and 0.5Hz reversed cyclic ($0.1s^{-1}$) tests, respectively. Unfortunately the strain rate for the 100mm/min coupon tests was limited by the capability of the screw driven materials testing machine; nonetheless, the corresponding strain rate was substantially higher than the slowest coupon tests (approximately 1000 times). The yield strength, F_y , and tensile strength, F_u , were generally observed to increase for steels as the strain rate increased; the ratio F_u/F_y exceeded the 1.2 lower limit specified by AISI S213.

Table 2.7: Material properties of strap braces

Strap width, mm (in)	Cross-head rate (mm/min)	Strain rate ($\times 10^3 s^{-1}$)	Nominal thickness, t_n (mm)	Base metal thickness, t_{avg} (mm)	Yield stress, F_y (MPa)	Ultimate stress, F_u (MPa)	F_u / F_y	% Elongation	F_y / F_{yn}
63.5 (2 1/2)	0.1	0.021	1.09	1.11	296	366	1.24	32.5	1.29
	50	10.4	1.09	1.11	310	381	1.23	30.4	1.35
	100	20.8	1.09	1.11	314	377	1.20	31.8	1.36
69.9 (2 3/4)	0.1	0.021	1.37	1.41	387	560	1.45	27.2	1.14
	50	10.4	1.37	1.41	406	571	1.41	26.7	1.19
	100	20.8	1.37	1.42	406	584	1.44	28.1	1.19
101.6 (4)	0.1	0.021	1.73	1.79	353	505	1.43	32.4	1.04
	50	10.4	1.73	1.78	372	521	1.40	30.7	1.10
	100	20.8	1.73	1.79	373	521	1.40	31.6	1.10

Table 2.8 : Material properties of studs, tracks and gusset plates

Member	Cross-head rate ^a (mm/min)	Strain rate ($\times 10^3 s^{-1}$)	Nominal thickness, t_n (mm)	Base metal thickness, t_{avg} (mm)	Yield stress, F_y (MPa)	Ultimate stress, F_u (MPa)	F_u / F_y	% Elongation	F_y / F_{yn}
0.043 Stud	0.1	0.021	1.09	1.16	325	382	1.18	28.8	1.41
0.043Track	0.1	0.021	1.09	1.11	296	366	1.24	32.5	1.29
0.054 Stud	0.1	0.021	1.37	1.41	387	560	1.45	27.2	1.14
0.054 Track	0.1	0.021	1.37	1.41	387	560	1.45	27.2	1.14
0.054 Gusset	0.1	0.021	1.37	1.41	387	560	1.45	27.2	1.14
0.068 Stud	0.1	0.021	1.73	1.80	348	505	1.45	27.9	1.02
0.068 Track	0.1	0.021	1.73	1.79	353	505	1.43	32.7	1.04
0.068 Gusset	0.1	0.021	1.73	1.79	353	505	1.43	32.7	1.04
0.097 Track	0.1	0.021	2.46	2.53	336	463	1.38	33.8	0.99

^a Cross-head rate was increased to 6 mm/min after full yielding was achieved.

In all cases the ratio of F_u/F_y was greater than 1.08 and the percentage elongation over a 50mm gauge length exceeded 10%; therefore, these steels also met the requirements laid out by CSA S136, the relevant Canadian standard.

2.10. Observed Performance

The test walls generally performed as expected given the capacity approach that was taken in design; that is, the straps first behaved elastically, then yielding spread along the full length of the strap with some strain hardening.

In a limited number of cases, the straps did fracture at high storey drift, far beyond that which would be anticipated during a seismic event. The other elements in the seismic force resisting system remained relatively undamaged. The only exceptions were for the 1220 and 610mm long walls in which the chord studs were damaged by combined axial and flexural forces. The addition of screws to

the braces did not alter the performance of the walls with respect to those specimens in which braces did not contain screws. Strap fracture at large drifts always occurred at the leading edge of the welded connection, and never through the net section at a strap screw-hole location. Table 2.9 summarizes the observed behaviour for all walls.

Table 2.9: Summary of failure modes

Wall (Aspect ratio)	Test ^{a,b}	Failure mode(s)	
1 : 1	13A-M	1	Yielding of braces over full length, drift over 8% reached; limited by stroke of actuator
		2	Yielding of braces over full length, test stopped to preserve specimen at 7.9% drift
	14A-C		Yielding of braces over full length, maximum drift of $\pm 4.5\%$ limited by stroke of actuator
	15A-M	1	Yielding of braces over full length, drift over 8% reached; limited by stroke of actuator
		2	Yielding of braces over full length, drift over 8% reached; limited by stroke of actuator
	16A-C		Yielding of braces over full length, maximum drift of $\pm 4.5\%$ limited by stroke of actuator
	17A-M	1	Yielding of braces over full length, net section fracture of one brace at 8.1% drift, other brace continued to carry load to maximum drift of 9.0%
		2	Yielding of braces over full length, net section fracture of one brace at 7.8% drift, other brace continued to carry load to maximum drift of 8.4%
	18A-C		Yielding of braces over full length, maximum drift of $\pm 4.5\%$ limited by stroke of actuator
	19A-M	1	Yielding of braces over full length, drift over 8% reached; limited by stroke of actuator
		2	Yielding of braces over full length, test stopped to preserve specimen at 7.2% drift
	20A-C		Yielding of braces over full length, maximum drift of $\pm 4.5\%$ limited by stroke of actuator
	21A-M	1	Yielding of braces over full length, drift over 8% reached; limited by stroke of actuator
		2	Yielding of braces over full length, drift over 8% reached; limited by stroke of actuator
22A-C		Yielding of braces over full length, maximum drift of $\pm 4.5\%$ limited by stroke of actuator	
23A-M	1	Yielding of braces over full length, net section fracture of one brace at 8.1% drift, other brace followed with net section fracture at 8.2% drift	
	2	Yielding of braces over full length, net section fracture of one brace at 8.2% drift, test stopped to preserve specimen	
24A-C		Yielding of braces over full length, maximum drift of $\pm 4.5\%$ limited by stroke of actuator	
1 : 2	15B-M	1	Yielding of braces over full length, drift over 8% reached; limited by stroke of actuator
		2	Yielding of braces over full length, test stopped to preserve specimen at 8.1% drift
	16B-C		Yielding of braces over full length, maximum drift of $\pm 4.6\%$ limited by stroke of actuator
	23B-M	1	Yielding of braces over full length, combined compression and bending failure of chord stud, test stopped to preserve specimen at 6.4% drift
		2	Yielding of braces over full length, combined compression and bending failure of chord stud at 5.4% drift
24B-C		Yielding of braces over full length, small local buckling of lip and flange of chord studs, maximum drift of $\pm 4.2\%$ limited by stroke of actuator	
1 : 4	19B-M	1	Yielding of braces over full length, combined compression and bending failure of chord stud, test stopped to preserve specimen at 5.4% drift
		2	Yielding of braces over full length, combined compression and bending failure of chord stud at 6.4% drift
	20B-C		Yielding of braces over full length, local buckling of lip and flange of chord stud due to combined compression and bending forces, maximum drift of $\pm 4.2\%$ limited by stroke of actuator
	23C-M	1	Yielding of braces over full length, combined compression and bending failure of chord stud at 6.3% drift
		2	Yielding of braces over full length, combined compression and bending failure of chord stud at 5.2% drift
24C-C		Yielding of braces over full length combined compression and bending failure followed by crushing of chord studs, maximum drift of $\pm 4.9\%$ limited by stroke of actuator	

^a1 denotes pull direction test with no screws through straps; 2 denotes push direction test with screws through straps at interior stud locations

^bCyclic tests had screws through straps at interior stud locations in the push direction only

2.10.1. *Light Walls*

The only mode of failure observed for the light walls was full strap yielding with strain hardening (Figure 2.22). In each case, the test was limited by the stroke of the actuator. A minor amount of elastic distortion and local buckling was observed in the chord studs but only at very high drift levels ($>6\%$). Yielding initially occurred at the screw locations (Figure 2.22); however this was followed by strain hardening over the net section which allowed for the remaining portions of the braces to yield.



Figure 2.21: Light walls 16A-C and 16B-C

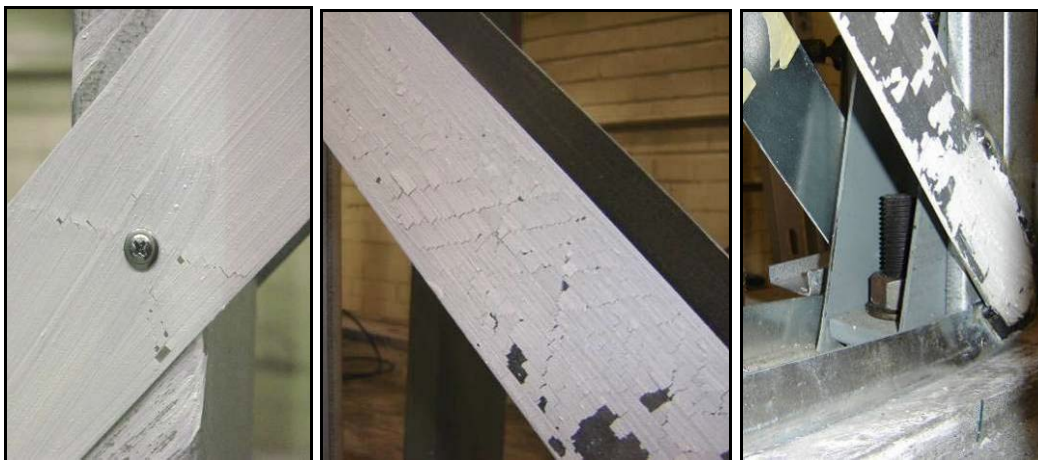

Figure 2.22: Yielding in light walls

2.10.2. *Medium Walls*

The medium walls also exhibited full strap yielding (Figure 2.23). Tests 17A-M1 and 17A-M2 ultimately failed by net section fracture, which occurred at the leading edge of the welded connection where small undercutting existed (Figure 2.24). No fractures were seen at screw-hole locations where the strap was connected to the interior studs (Figure 2.23). The fractures started from the side of the brace subjected to higher tension stress due to the rotation of the rigid corner connection and holddown. It should be noted that in the worst case, this type of fracture was only observed at a drift level of 7.8%. Tests 19A-M1, 19A-M2, 18A-C and 20A-C showed full cross section yielding; no net section fracture was observed.



Figure 2.23: Medium walls showing brace yielding

Tests 19B-M1, 19B-M2, both 610 x 2440mm specimens, saw some strap yielding prior to combined compression / flexure failure of the chord studs (Figure 2.25).

The recorded drifts at failure were not as high as those for similar tests 19A-M1 and 19A-M2, which were both 2440 x 2440mm specimens. Test 20B-C did not experience chord stud failure because the deflection of the wall was limited by the stroke of the actuator. At a maximum drift of $\pm 4.2\%$ some local buckling of the lip and flanges of the chord stud was observed.



Figure 2.24: Medium wall strap connection prior to testing and after net section strap failure at 7.8% drift



Figure 2.25: Chord stud failure in specimens 19B-M1 and 19B-M2

2.10.3. *Heavy Walls*

The 2440 x 2440mm heavy test specimens exhibited full brace yielding up to a lateral drift exceeding 8% (monotonic) and $\pm 4.5\%$ (cyclic). Monotonic test specimens 23A-M1 and 23A-M2 failed from net section fracture of the brace at this high drift level (Figure 2.26) while specimens 21A-M1 and 21A-M2 did not. Cyclic tests 22A-C and 24A-C showed strap yielding with no other damage to the wall.



Figure 2.26: Net section strap failure of specimen 23A-M2 at 8.2% drift

The 1220 x 2440mm walls displayed full brace yielding followed by eventual failure of the chord stud at an average lateral drift of 6.0%. The cyclic test, 24B-C saw full yielding of the braces and some local buckling of the lip and flange of the chord studs. The braces of the 610 x 2440mm walls did reach their yield capacity; however no plateau was visible in the resulting load displacement curve (Figure A.10, Appendix A). This was due to the failure of the chord studs at an average drift of about 4.3%. The cyclic test specimen, 24C-C, saw complete compression / flexural failure of the chord studs during the test (Figure 2.27).



Figure 2.27: Post test specimen 24B-C (1220 x 2440mm); specimen 24C-C (610 x 2440mm)

2.11. Summary and Discussion of Test Results

2.11.1. *Lateral Wall Resistance*

The measured, S_y , and predicted, S_{yp} , yield resistance values, as well as the test-to-predicted ratios, S_y/S_{yp} and S_y/S_{yn} , are provided in Table 2.10 for the monotonic tests and Table 2.11 for the cyclic tests. The ratio of S_y/S_{yp} varies from 1.11 (13A-M1) to 0.89 (23C-M1) but was generally close to or above unity. S_{yp} does not take into account any racking strength that could develop due to a moment resistance at the track to chord stud connections, especially where gusset plates were used. Interior stud to track connections could also provide a minimal flexural resistance that would have been measured during lateral displacement of the wall. The S_y/S_{yp} ratio was expected to be greater than one because of this small flexural connection resistance. This was the case for almost all the 1:1 aspect ratio walls, except for 19A-M2 and 23A-M2 ($S_y/S_{yp} = 0.99$). The cyclic tests showed slightly higher S_y/S_{yp} ratios, mainly because S_y includes strain hardening and strain rate effects.

The 1:2 walls showed yielding performance similar to that of the 1:1 walls except in the heavy wall case where minimal chord stud flexural/compression failure occurred. This may have limited the full yielding capacity of the braces from being reached and is shown by an S_y/S_{yp} ratio slightly less than one. The S_y/S_{yp} ratio was found to be less than one for all 1:4 aspect ratio walls (monotonic and cyclic), especially for the heavy specimens where values ranged from 0.68 to 0.90. The 610mm long (1:4) walls failed through chord stud flexure / compression, and thus, were not able to achieve a lateral resistance corresponding to yielding of the braces. The resistance vs. lateral drift hysteretic response from heavy test specimens 24A-C, 24B-C and 24C-C shows graphically how the predicted yield resistance could not be reached by the 1:4 wall (Figure 2.28).

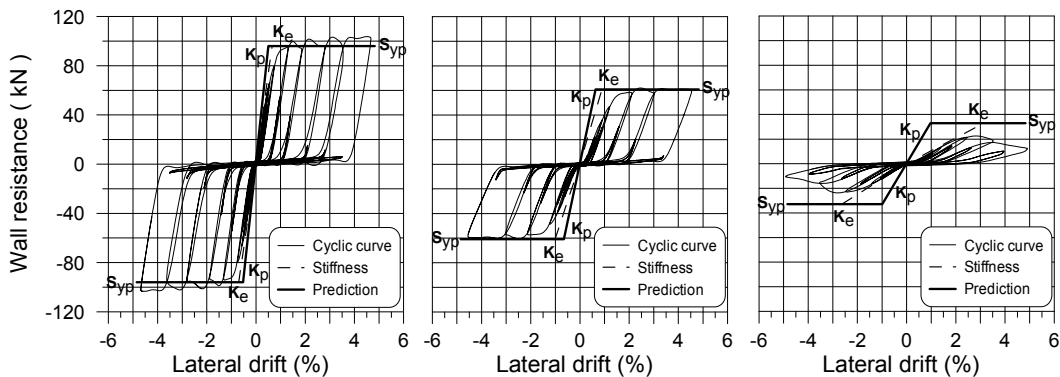

Figure 2.28: Resistance vs. lateral drift hysteretic responses for heavy walls 24A-C (1:1), 24B-C (1:2) and 24C-C (1:4)

Table 2.10 and Table 2.11 also list the ratio of yield resistance, S_y , to nominal yield resistance, S_{yn} . These ratios show the overstrength that strap braced walls, excluding the 1:4 walls, achieved when displaced into the inelastic range.

The ratio of S_y/S_{yc} , also shown in the tables, includes the R_y value used in design. It is desired that this ratio be close to or less than 1.0 because if the actual yield load, S_y , is greater than the design probable force level other components in the SFRS may fail first when using capacity design. These ratios vary from 0.91 to 1.11 for 1:1 and 1:2 monotonic tests and are therefore within an acceptable range. The same ratios from the cyclic tests, which include strain hardening and strain rate effects, give a range of 1.02 to 1.26. Though this ratio is greater than 1.0 in all cases for the cyclic tests, which are designed to simulate seismic loading (excluding 1:4 walls, where full brace yielding was not seen), the capacity design worked in that the desired ductile failure mode was seen. Net section fracture of the braces was only seen at a drift level higher than is generally expected during rare seismic events. This shows that AISI S213 R_y and R_t factors used to predict the brace force for capacity design work well together and are valid for design. In order to recommend changes for either of these values tests on samples from many coils would have to be undertaken (these results are based on three strap sizes, which were taken from three coils). The light, medium and heavy wall ratios were grouped around similar ranges and follow the same trend as the respective F_y/F_{yn} ratios from material properties testing (Table 2.7).

A comparison was made between walls with different aspect ratios by converting the lateral load to strap stress, a function of wall geometry and measured brace cross sectional area (Figure 2.29). The higher aspect ratio walls (1:4) could not achieve the brace yield stress while the others were able to (1:1, 1:2).

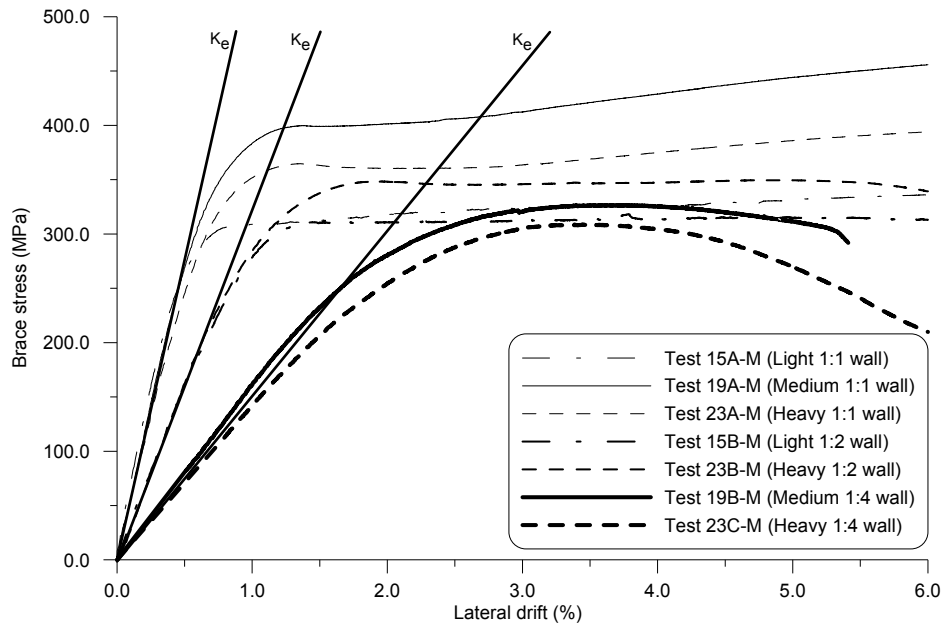

Figure 2.29: Comparison of brace stress with lateral drift for the 1:1, 2:2 and 1:4 aspect ratio walls

2.11.2. *Lateral Wall Stiffness*

The measured elastic wall stiffness, K_e , was always lower than the predicted stiffness, K_p . The calculated results and a comparison of the test-to-predicted values are shown in Table 2.10 for the monotonic tests and Table 2.11 for the cyclic tests. The over prediction of elastic stiffness can be attributed to the simplified method used to calculate K_p (Section 2.8). This prediction excluded factors such as flexibility of the chord studs, gusset plates and weld connections but gave a reasonable estimate of wall stiffness for 1:1 tests. The stiffness predictions became increasingly inaccurate with the higher aspect ratios. This may have been caused by the above mentioned factors becoming more dominant in overall system stiffness, as the wall moved from a shear type system to a bending situation (cantilever).

It was determined that aspect ratio, regardless of strap size, had a large effect on lateral stiffness. The average lateral stiffness' of 1:1, 1:2 and 1:4 walls were 3.82, 1.37 and 0.40 kN / mm respectively. This shows an approximate increase in wall flexibility of 2.8 when going from a 1:1 to 1:2 wall and 9.6 when going from a 1:1 to 1:4 aspect ratio wall. Given these results, it is recommended that when designing with this type of SFRS walls with a height over length ratio greater than two be avoided.

2.11.3. Seismic Force Modification Factors

Structures that are designed using linear elastic methods but respond in the non-linear inelastic range need R factors to estimate equivalent seismic loads using the NBCC. The test-based ductility, R_d , and overstrength, R_o , factors were calculated according to the procedure outlined in Section 2.8. These values, along with the wall ductility, μ , are summarized in Table 2.12 for the monotonic tests and Table 2.13 for the cyclic tests. The target seismic force modification factors for a limited ductility (Type LD) concentrically braced frame CFS system as given in AISI S213 (2007) are $R_d = 2.0$ and $R_o = 1.3$. The test calculated R_d values were all over the design $R_d = 2.0$, except in the case of 1:4 walls, where adequate strap yielding was not observed. The R_o values were slightly less than 1.3 for the heavy walls, but found satisfactory all other tests, excluding the 1:4 walls. The low R_o values for the heavy walls can be attributed to the low F_y/F_{yn} ratio for the steel (1.04) (Table 2.7). This ratio is typically 1.1 for 340MPa grade steel (AISI S213, 2007). Furthermore, the R_o calculation approach neglected other factors that would further increase the overstrength such as member oversize and development of a

collapse mechanism (Mitchell *et al.*, 2003). With this in mind, it can be said that the AISI prescribed R_d and R_o values can be achieved by this type of wall, except when a high aspect ratio (1:4) is used.

2.11.4. Energy Calculations

Energy absorption is related to ductility in that it depends on the walls ability to maintain a resistance through a large range of deflections. The energy results, like the ductility values, can be misleading because some tests were stopped before complete failure of the specimen. In order to compare walls within the same load level the energy results (Table 2.12 (monotonic) and Table 2.13 (cyclic)) were normalized with respect to the lateral drift (Figure 2.30) for monotonic test results only.

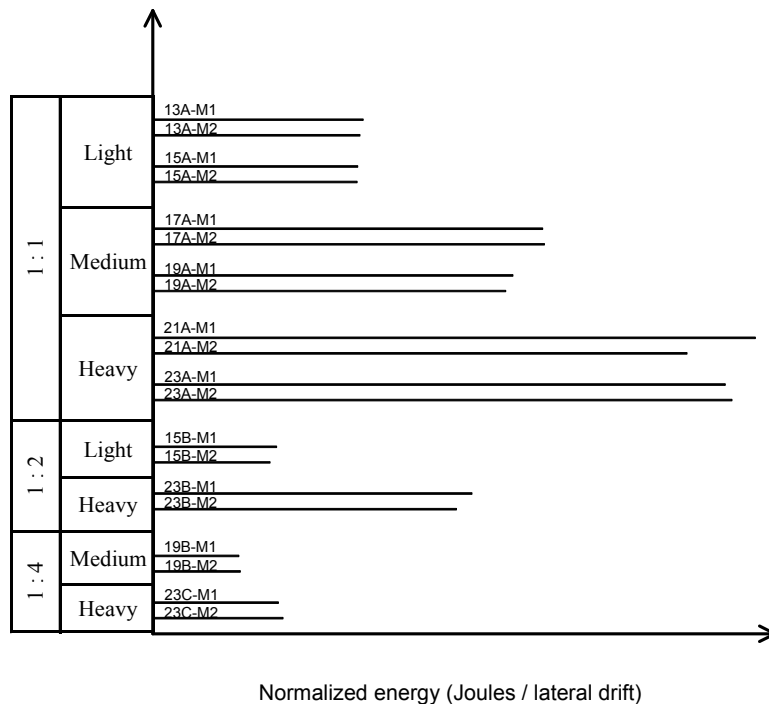

Figure 2.30: Normalized energy from monotonic test results

Within the 1:1 aspect ratio group, where great ductility was shown for all specimens, walls with larger straps (heavy) were able to absorb more energy than walls with smaller ones (light and medium) as is expected due to their higher load level. This figure proves that test results within each load level group are comparable; quality of the fabrication and testing process is demonstrated.

2.11.5. General Discussion

The capacity design procedure as found in AISI S213 generally provided for ductile wall behaviour well into the inelastic range. The NBCC related R_d and R_o factors recommended in AISI S213 are within the range of measured wall performance and can therefore be used in design for 1:1 and 1:2 aspect ratio walls. The AISI S213 prescribed values for R_y and R_t also proved to work well together and provided for the desired failure mode (strap yielding) to be dominant throughout testing results. Welded connections performed as expected and no premature net section fracture of the strap braces (as can be the case with screwed connected straps (*Al-Kharat & Rogers, 2008*)) was observed.

Deficiencies found during this testing lie in the prediction of elastic stiffness of CFS strap braced walls and the performance of 1:4 aspect ratio walls. More research is needed in both these areas. The use of 1:4 aspect ratio walls is not recommended until further investigations into their performance are carried out due to the inability to accurately predict the yield load, which is especially important when using nominal capacities with capacity based design.

Table 2.10: Comparison of measured, predicted and nominal elastic stiffness and yield resistance for monotonic tests

Wall		Test	K_c (kN/mm)	K_p (kN/mm)	K_c/K_p	K_c/K_n	S_y (kN)	S_{yp} (kN)	S_y/S_{yp}	S_y/S_{yn}	S_y/S_{yc}	
1 : 1	Light	13A-M	1	2.87	3.44	0.83	0.85	32.98	29.67	1.11	1.48	0.99
			2	2.71	3.48	0.78	0.80	32.51	30.18	1.08	1.46	0.97
		15A-M	1	2.68	3.43	0.78	0.80	31.05	29.65	1.05	1.39	0.93
			2	2.18	3.43	0.64	0.65	32.78	29.59	1.11	1.47	0.98
	Medium	17A-M	1	3.35	4.80	0.70	0.72	55.66	54.33	1.02	1.19	1.08
			2	3.22	4.80	0.67	0.69	57.28	54.31	1.05	1.22	1.11
		19A-M	1	3.27	4.81	0.68	0.70	56.66	54.53	1.04	1.21	1.10
			2	3.41	4.81	0.71	0.73	54.16	54.53	0.99	1.16	1.05
	Heavy	21A-M	1	5.83	7.65	0.76	0.78	92.68	90.66	1.02	1.08	0.98
			2	5.37	7.69	0.70	0.72	92.04	91.24	1.01	1.08	0.98
		23A-M	1	5.45	7.71	0.71	0.73	93.07	91.68	1.02	1.09	0.99
			2	5.50	7.69	0.72	0.74	90.51	91.24	0.99	1.06	0.96
1 : 2	Light	15B-M	1	0.84	1.73	0.49	0.49	20.22	18.66	1.08	1.43	0.95
			2	0.89	1.73	0.51	0.52	19.18	18.75	1.02	1.36	0.91
	Heavy	23B-M	1	2.08	3.88	0.54	0.55	55.71	57.76	0.96	1.03	0.94
			2	1.66	3.88	0.43	0.44	57.36	57.70	0.99	1.06	0.96
1 : 4	Medium	19B-M	1	0.33	0.83	0.40	0.41	18.11	18.68	0.97	1.13	1.03
			2	0.31	0.83	0.37	0.39	18.49	18.68	0.99	1.15	1.05
	Heavy	23C-M	1	0.47	1.39	0.34	0.35	27.83	31.42	0.89	0.95	0.86
			2	0.50	1.38	0.36	0.37	28.00	31.28	0.90	0.95	0.87

Table 2.11: Comparison of measured, predicted and nominal elastic stiffness and yield resistance for cyclic tests

Wall		Test ^a	K_e (kN/mm)	K_p (kN/mm)	K_e/K_p	K_e/K_n	S_y (kN)	S_{yp} (kN)	S_y/S_{yp}	S_y/S_{yn}	S_y/S_{yc}	
1 : 1	Light	14A-C	-ve	2.80	3.44	0.81	0.83	36.59	31.52	1.16	1.64	1.09
			+ve	2.93	3.44	0.85	0.87	36.72	31.52	1.16	1.65	1.10
		16A-C	-ve	3.11	3.44	0.90	0.92	36.29	31.47	1.15	1.63	1.08
			+ve	2.71	3.44	0.79	0.80	35.79	31.47	1.14	1.60	1.07
	Medium	18A-C	-ve	3.46	4.79	0.72	0.74	62.04	57.18	1.08	1.33	1.21
			+ve	3.91	4.79	0.82	0.84	63.48	57.18	1.11	1.36	1.23
		20A-C	-ve	3.96	4.81	0.82	0.85	64.27	57.25	1.12	1.37	1.25
			+ve	3.59	4.81	0.75	0.77	64.86	57.25	1.13	1.39	1.26
	Heavy	22A-C	-ve	5.95	7.68	0.77	0.80	104.12	96.27	1.08	1.22	1.11
			+ve	6.21	7.68	0.81	0.83	108.72	96.27	1.13	1.27	1.15
		24A-C	-ve	5.70	7.67	0.74	0.76	103.38	95.97	1.08	1.21	1.10
			+ve	5.92	7.67	0.77	0.79	103.66	95.97	1.08	1.21	1.10
1 : 2	Light	16B-C	-ve	0.99	1.73	0.57	0.58	22.11	19.88	1.11	1.57	1.04
			+ve	0.89	1.73	0.51	0.52	22.22	19.88	1.12	1.57	1.05
	Heavy	24B-C	-ve	1.97	3.87	0.51	0.52	60.57	60.85	1.00	1.12	1.02
			+ve	2.07	3.87	0.53	0.55	61.97	60.85	1.02	1.14	1.04
1 : 4	Medium	20B-C	-ve	0.37	0.83	0.45	0.46	19.46	19.63	0.99	1.21	1.10
			+ve	0.36	0.83	0.43	0.45	19.20	19.63	0.98	1.20	1.09
	Heavy	24C-C	-ve	0.51	1.38	0.37	0.38	23.76	32.96	0.72	0.81	0.74
			+ve	0.43	1.38	0.31	0.32	22.44	32.96	0.68	0.76	0.69

^a '-ve' and '+ve' denote values from the negative and positive load and displacement side if the test hysteresis respectively.

Table 2.12: Other measured test properties for monotonic tests

Wall		Test	Ductility, μ (mm/mm)	Energy (Joules)	Lateral Δ_{max} (mm)	Lateral drift (%)	R_d	R_o	
1 : 1	Light	13A-M	1	18.7	7272	215	8.8	6.03	1.72
			2	16.0	6411	193	7.9	5.57	1.71
		15A-M	1	19.0	7234	220	9.0	6.08	1.67
			2	13.7	6792	207	8.5	5.15	1.68
	Medium	17A-M	1	11.8	12321	197	9.0	4.76	1.44
			2	10.2	11467	182	8.4	4.41	1.46
		19A-M	1	11.7	12482	216	8.9	4.73	1.46
			2	11.1	9973	176	7.2	4.60	1.44
	Heavy	21A-M	1	13.0	20166	208	8.5	4.99	1.31
			2	10.3	17008	198	8.1	4.43	1.28
		23A-M	1	11.3	18319	199	8.2	4.65	1.27
			2	12.2	18644	200	8.2	4.83	1.26
1 : 2	Light	15B-M	1	9.09	4344	218	9.0	4.14	1.65
			2	9.62	3928	208	8.6	4.27	1.58
	Heavy	23B-M	1	5.81	8004	156	6.4	3.26	1.18
			2	3.78	6476	133	5.4	2.56	1.19
1 : 4	Medium	19B-M	1	2.41	1829	132	5.4	1.95	1.25
			2	2.66	2211	157	6.4	2.08	1.28
	Heavy	23C-M	1	2.34	3089	153	6.3	1.92	1.05
			2	2.26	2672	128	5.2	1.88	1.06

Table 2.13: Other measured test properties for cyclic tests

Wall			Test ^a	Ductility, μ (mm/mm)	Energy (Joules)	Lateral Δ_{max} (mm)	Lateral drift (%)	R_d	R_o
1 : 1	Light	14A-C	-ve	8.35	9897	109	4.5	3.96	1.82
			+ve	8.73		109	4.5	4.06	1.83
		16A-C	-ve	9.72	9627	113	4.6	4.29	1.81
			+ve	8.58		113	4.6	4.02	1.78
	Medium	18A-C	-ve	6.36	14579	114	4.7	3.42	1.47
			+ve	7.02		114	4.7	3.61	1.51
		20A-C	-ve	6.78	14986	110	4.5	3.54	1.53
			+ve	6.10		110	4.5	3.35	1.54
	Heavy	22A-C	-ve	6.44	24556	113	4.6	3.45	1.35
			+ve	7.08		124	5.1	3.63	1.41
		24A-C	-ve	6.28	24366	114	4.7	3.40	1.34
			+ve	6.52		114	4.7	3.47	1.35
1 : 2	Light	16B-C	-ve	5.06	5556	112	4.6	3.02	1.74
			+ve	4.50		113	4.6	2.83	1.75
	Heavy	24B-C	-ve	3.60	12960	111	4.5	2.49	1.24
			+ve	3.70		111	4.5	2.53	1.27
1 : 4	Medium	20B-C	-ve	2.34	4117	123	5.0	1.92	1.35
			+ve	1.94		103	4.2	1.70	1.33
	Heavy	24C-C	-ve	2.59	6494	120	4.9	2.04	0.90
			+ve	2.28		120	4.9	1.89	0.85

^a '-ve' and '+ve' denote values from the negative and positive load and displacement side if the test hysteresis respectively.

3.0 DYNAMIC ANALYSIS

In order to confirm the limited ductility R values and the height limit tabulated for Canadian design in AISI S213 (2007) dynamic analyses of representative multi-storey braced frame structures were carried out. The single-storey displacement controlled wall tests (Chapter 2.0) need to be supplemented with an investigation into overall building performance to prove the validity of the AISI S213 design method. Also, in order for CFS systems to be included in the 2005 NBCC seismic design provisions (NRCC 2005a) analysis of this nature must be completed. Of significant concern is the possibility of a concentration of demand in a single storey (soft storey effect) which cannot be evaluated through the testing of single-storey assemblies. The non-linear dynamic analysis program RUAUMOKO (Carr, 2000) was selected to run the analyses. An example structure was chosen and seismic design was carried out according to the 2005 NBCC equivalent static force procedure. Care was taken to follow the steps of a practising engineer who would not have analytical test data to make use of. The building was assumed to be located in Vancouver, Canada, and situated on site class C. A bi-linear with slackness spring element provided within the RUAUMOKO software was used to model the strap braces.

This example structure was modeled using various building heights and design criteria. Preliminary investigations (only inter-storey drifts examined) included two, four, six and seven storey models. Further analyses of the six and seven storey structures were completed to experiment with different brace selection

criterion, building height and R values using the incremental dynamic analysis approach and the evaluation of collapse probability with the aid of fragility curves. Initially, brace sizes were chosen based on the minimum required cross sectional area (most economical). Other model iterations used only one change in brace size over the height of the structure. This variation in brace selection is of interest because it would simplify the construction process. The design of a building was also done using an R of 4.0 (compared with $R_d R_o = 2.6$) as this is given in ASCE/SEI 7-05 (2005) and TI 809-07 (2003) for use in the USA. Use of a larger seismic force modification factor further reduces the design base shear resulting in smaller brace sizes, and therefore, a more flexible structure.

In order to evaluate the R factors and the AISI S213 height limit of 20m (the six and seven storey models), the general procedure provided by ATC-63 (2008) was followed. ATC-63 contains a methodology with which the “quantification of building system performance and response parameters” for seismic design can be achieved; specifically, it addresses the evaluation of the response modification coefficient (R factor), also known as the seismic force modification factors R_d and R_o in Canada. The procedure covers model selection, input ground motion selection and scaling, incremental dynamic analysis (Vamvatsikos & Cornell, 2002), development of collapse probability curves and validation of design R factors. It was necessary to make some adjustments to account for Canadian seismic design and hazard aspects which are not covered in the US document.

3.1. Model Building Design

As CFS structures are directly comparable to typical platform frame wood construction in terms of expected load level and building size, the model buildings were chosen to be similar to that used by the NEESwood project (Cobeen *et al.*, 2007). The model buildings (Table 3.1) differ from the US study, however, in that they were located in Vancouver Canada and that the overall design adhered to the provisions of the National Building Code of Canada. Nonetheless, the general similarity of the buildings allows for future comparison of results. The model names, as given in the first column of the table, provide the number of storeys, the combined $R_d \times R_o$ factor and the brace selection criterion (Section 3.1.2), respectively.

Table 3.1: General model parameters

Model Name		Number of storeys	Height, h (m)	Number of braced wall towers
2S	$R_dR_o2.6$ -minbrace	2	6.7	5
4S	$R_dR_o2.6$ -minbrace	4	12.8	5
6S	$R_dR_o2.6$ -minbrace	6	18.9	5
	$R_dR_o2.6$ -2brace			5
	R_dR_o4 -minbrace			5
7S	$R_dR_o2.6$ -minbrace	7	22.0	6
	$R_dR_o2.6$ -2brace			6
	R_dR_o4 -minbrace			5

Elevation and plan views of the example structure are shown in Figure 3.1. The proposed locations of the walls for the residential style apartment building, composed of a cold-formed steel gravity and lateral framing system, are shown in Figure 3.2 for model 6S $R_dR_o2.6$ -minbrace. Tributary area (TA), along with building length and width dimensions are also given in this figure. All braced

walls were 2740mm (9') in length. Similar layouts were used for other models, except where six braced wall towers were necessary (models 7S R_dR_o2.6-minbrace and 7S R_dR_o2.6-2brace); the extra tower was placed along the centre line of the structure in the considered loading direction. It is generally more efficient to place braced walls along the perimeter but this was not always possible due to the large number of window openings in the residential structure. Due to the assumption of a rigid floor diaphragm and symmetry within the example structure, results of an earthquake acting in the east-west direction will be the same as those for the north-south direction, thereby eliminating the need to consider ground motion in two planes.

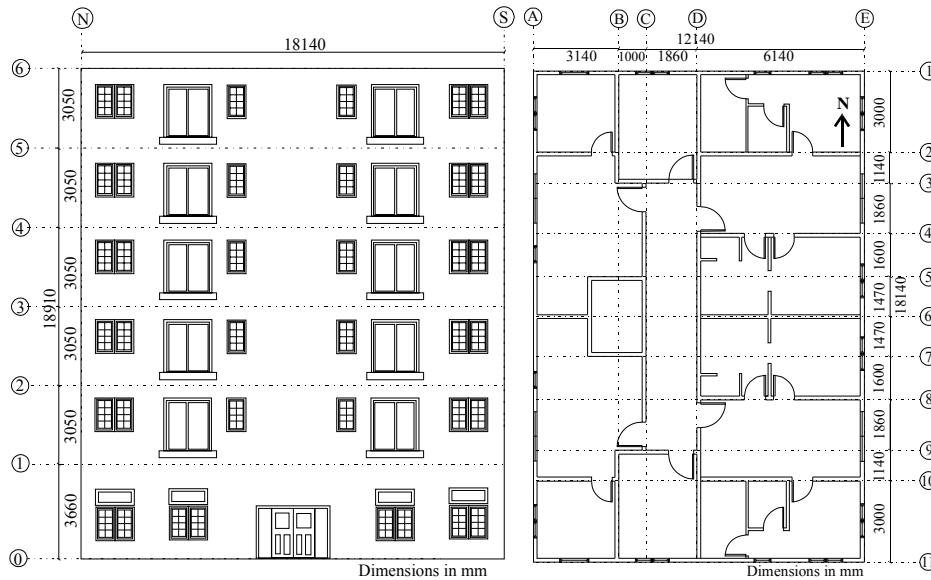

Figure 3.1: Elevation and plan view of model 6S R_dR_o2.6-minbrace

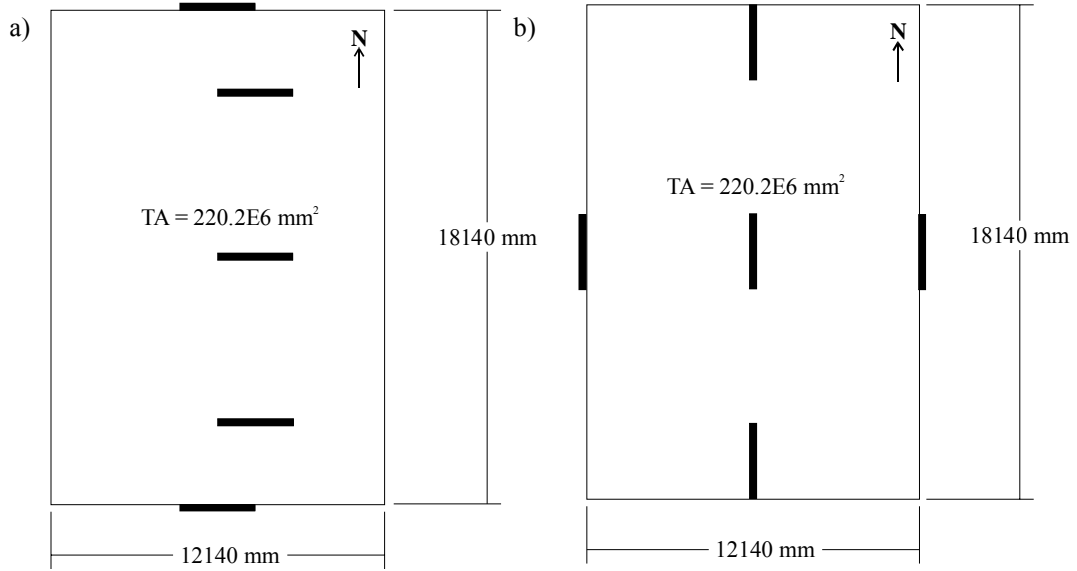

Figure 3.2: Braced wall location for model 6S R_dR_o2.6-minbrace a) E-W direction earthquake, and b) N-S direction earthquake

The interior floors were chosen to be concrete and the Hambro® D500 document (*Canam Group, 2004*) was used to determine the specified dead loads (Figure 3.3). Other dead load values were defined using the Handbook of Steel Construction, 8th edition (*CISC, 2004*).

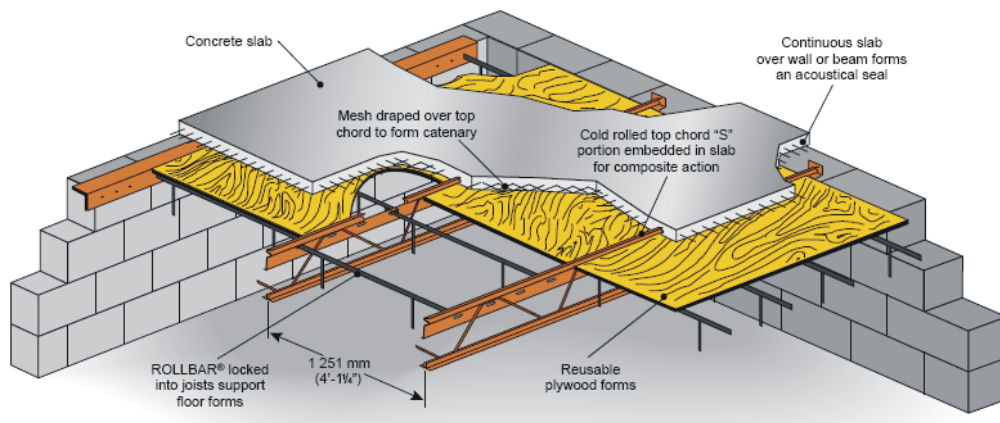

Figure 3.3: Hambro® D500 floor system (*Canam Group, 2004*)

A summary of the specified dead, live and snow loads used for design is shown in Table 3.2. The specified snow load presented in the table was calculated in accordance with the 2005 NBCC using Equation 3-1.

$$S = I_s [S_s (C_b C_w C_s C_a) + S_r] \quad (3-1)$$

where,

I_s = importance factor for snow load, 1.0

S_s = 1/50 year ground snow load, 1.8kPa

S_r = 1/50 year associated rain load, 0.2kPa

C_b = basic roof snow load factor, 0.8

C_w = wind exposure factor, 1.0

C_s = roof slope factor, 1.0

C_a = shape factor, 1.0

Earthquake loads were calculated using the 2005 NBCC equivalent static design procedure. The equations used and the loads and deflections, calculated for the six storey example building, are shown in the following sections. Only the seismic loading case, NBCC load case 5 (Equation 3-2), was considered in this design therefore wind loading effects have not been calculated.

$$W_f = 1.0D + 1.0E + 0.5L + 0.25S \quad (3-2)$$

where,

D = specified dead load

E = specified earthquake load

L = specified live load

S = specified snow load

Table 3.2: Specified dead, live and snow loads

Dead loads		
Roof	Sheathing (3/4in plywood)	0.10 kPa
	Insulation (100mm blown fibre glass)	0.04 kPa
	Ceiling (12.5mm Gypsum)	0.10 kPa
	Joists (cold-formed steel @600mm o/c)	0.12 kPa
	Sprinkler system	0.03 kPa
	Roofing (3ply + gravel)	0.27 kPa
	Mechanical	0.03 kPa
	D	0.69 kPa
Interior	Walls (interior and exterior)	0.72 kPa
	Flooring (25mm hardwood)	0.19 kPa
	Concrete slab (Hambro® system)	1.77 kPa
	Acoustic tile (12mm)	0.04 kPa
	Joists (cold-formed steel @600mm o/c)	0.12 kPa
	Mechanical	0.03 kPa
	D	2.87 kPa
Live loads		
Roof	Snow load (Equation 3-1)	
	S	1.64 kPa
Interior	Residential area	1.9 kPa
	L	1.9 kPa

3.1.1. 2005 NBCC Base Shear Calculation

The design base shear was calculated (Equations 3-3, 3-4, 3-5) then distributed among the levels of the example structure as per the 2005 NBCC. The calculation of seismic weight, W , was taken as the sum of the specified structure dead load, D , plus 25% of the snow load, S as per Equation 3-2 and is shown in Equation 3-6.

$$V = \frac{S(T)M_v I_E W}{R_d R_o} \quad (3-3)$$

$$V_{\min} = \frac{S(2.0)M_v I_E W}{R_d R_o} \quad (3-4)$$

$$V_{\max} = \frac{2 S(0.2) I_E W}{3 R_d R_o} \quad (3-5)$$

where,

$S(T)$ = spectral acceleration according to structure period and NBCC

location specific uniform hazard spectrum (UHS)

M_V = higher mode effects factor, 1.0 for site class C

I_E = importance factor, 1.0

R_d = ductility related seismic force modification factor, taken as 2.0

(Limited Ductility, AISI S213)

R_o = overstrength related seismic force modification factor, taken as 1.3

(Limited Ductility, AISI S213)

$$W = \sum_{i=1}^{n=6} W_i \quad (3-6)$$

W_{1-5} = dead load of 1st to 5th floors

$$W_{1-5} = (1.0 \times 2.87 \text{ kPa}) 219.7 \text{ m}^2 = 631 \text{ kN}$$

W_R = dead load of roof

$$W_R = (1.0 \times 0.69 \text{ kPa} + 0.25 \times 1.64 \text{ kPa}) 219.7 \text{ m}^2 = 242 \text{ kN}$$

$$W = 5 \times 631 + 242 = 3395 \text{ kN}$$

Note: models designed with a combined $R_d \times R_o$ value of 4.0 used the same procedure documented herein.

The structure's period was first determined using the empirical equation for braced frames (Equation 3-7) (*NRCC 2005a*). The 2005 NBCC (Cl.4.1.8.11.3d) allows the use of a design period of up to two times this period ($2T_a$) when a

fundamental period greater than $2T_a$ has been calculated through structure modeling.

$$T_a = 0.025(h_n) = 0.025(18.9\text{m}) = 0.47\text{s} \quad (3-7)$$

For the six storey example structure, the linear elastic period from RUAUMOKO dynamic analysis was found to be 1.09s, which is greater than $2T_a$ therefore the design period of $2T_a$ (0.945s) was used. The design UHS for Vancouver, site class C, is shown in Figure 3.4.

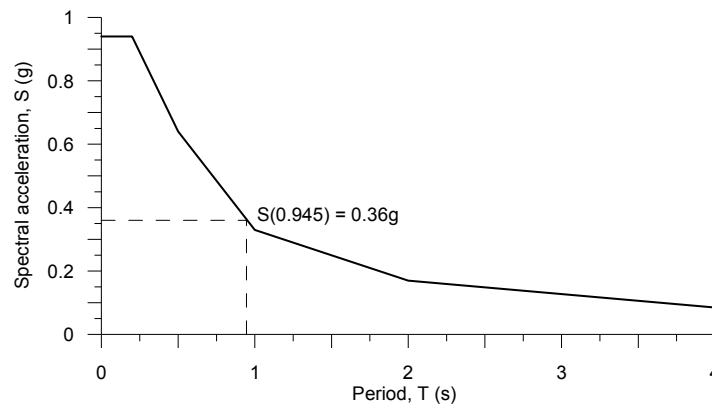

Figure 3.4: Design UHS for Vancouver, site class C

F_v and F_a are equal to 1.0 for Site Class C. The design spectral acceleration, $S(0.945)$, was then calculated using linear interpolation and found to be 0.36g. The base shear and base shear limits were then calculated using Equations 3-3, 3-4 and 3-5 respectively:

$$V = 475.4 \text{ kN}$$

$$V_{\min} = 222.0 \text{ kN} < V, \text{ ok}$$

$$V_{\max} = 818.3 \text{ kN} > V, \text{ ok}$$

The base shear applied to each storey, F_x , was distributed along the building height according to 2005 NBCC (Cl.4.1.8.11) (Equation 3-8).

$$F_x = \frac{(V - F_t)W_x h_x}{\sum_{i=1}^n W_i h_i} \quad (3-8)$$

where,

V = design base shear

$F_t = 0.07T_a V < 0.25V$ for $T_a > 0.7s$; $F_t = 0$ for $T_a < 0.7s$ (additional load at roof level to account for higher mode effects)

W_x = seismic weight at the storey under consideration

h_x = structure height at the storey under consideration

$\sum_{i=1}^n W_i h_i$ = the sum of seismic weight times storey height for all storeys

Notional loads calculated using Equation 3-2 were taken into account. 0.5% of the storey seismic weight was used; numbers below are for interior levels and the roof respectively:

$$N_{1-5} = 0.005 (1.0 \times 2.87 \text{kPa} + 0.5 \times 1.9 \text{kPa}) 219.7 \text{m}^2 = 4.2 \text{kN}$$

$$N_R = 0.005 (1.0 \times 0.69 \text{kPa} + 0.25 \times 1.64) 219.7 \text{m}^2 = 1.2 \text{kN}$$

Accidental eccentricity, T_x , was taken to act only, and entirely, on the shear walls at the building perimeter in the loading direction (as modeling was only done in 2D) and was taken as 10% of the seismic design load, F_x , respective to the storey under calculation. This conservative assumption gives worst case loading regardless of earthquake direction, and was used to simplify the design procedure because the varying model heights have slightly different shear wall configurations. A summary of the calculation of factored design storey shear, V_{fx} , is given in Table 3.3 and Appendix F for all models.

Table 3.3: Summary of design storey shear for building 6S R_aR_o2.6-minbrace

Storey	W _i (kN)	h _i (m)	W _i x h _i	F _x (kN)	T _x (kN)	N _x (kN)	V _{fx} (kN)	ΣV _{fx} (kN)
6	241.7	18.91	4571	88.9	8.9	1.2	99.0	99.0
5	630.6	15.86	10002	125.6	12.6	4.2	142.4	241.4
4	630.6	12.81	8078	101.5	10.1	4.2	115.8	357.2
3	630.6	9.76	6155	77.3	7.7	4.2	89.2	446.4
2	630.6	6.71	4232	53.1	5.3	4.2	62.7	509.1
1	630.6	3.66	2308	29.0	2.9	4.2	36.1	545.2
<i>Sum</i>	<i>3395</i>	<i>-</i>	<i>35346</i>	<i>475.4</i>	<i>-</i>	<i>-</i>	<i>545.2</i>	<i>-</i>

3.1.2. *Design of Strap Braces*

The design forces from the NBCC equivalent static procedure (Table 3.3 Table 3.3) were distributed among the braced wall towers assuming rigid diaphragm action and tension-only braces. Two brace selection criteria were used; 1) braces were chosen using a minimum brace size selection criterion (Section 3.1.2.1) (most economical in terms of weight of steel), and 2) braces were chosen using only two brace sizes over the height of the building (Section 3.1.2.2). The factored tension capacity of the braces and inelastic seismic drift limit of 2.5% were utilized in both design approaches. Wind loading and the related service level drift limit were not considered in the selection of the brace sizes. Limits on brace widths, w , were set based on lab experience and practicality. The overall minimum and maximum brace widths were $w_{min}= 64\text{mm}$ (2.5”) and $w_{max}= 165\text{mm}$ (6.5”), respectively. The brace thicknesses, t , and corresponding yield and ultimate stress values were consistent with the materials currently available in the marketplace:

$$t = 1.09\text{mm} (0.043”), F_y = 230\text{MPa}, F_u = 310\text{MPa}$$

$$t = 1.37\text{mm} (0.054”), F_y = 340\text{MPa}, F_u = 450\text{MPa}$$

$$t = 1.73\text{mm} (0.068”), F_y = 340\text{MPa}, F_u = 450\text{MPa}$$

3.1.2.1. Minimum Brace Size Selection Criterion

An initial brace thickness was assumed for the building. The braces at the first storey were selected to be at the upper end of the brace width criterion (approx. 152mm (6'')) in order to keep the same brace thickness throughout the height of the structure as the seismic design forces decreased. Brace widths at other levels were selected as needed. All brace widths were then rounded up to the nearest half inch (12.7 mm). This approach was followed because it provides for final brace sizes of consistent thickness and common widths, simplifying construction. However, this approach did allow for the possibility of a different brace size at each storey.

The calculations for sizing strap braces as outlined above are presented for the six storey design example (building 6S R_dR_o2.6-minbrace). The factored design force for tension only braces is shown in Equation 3-9.

$$T_{fdesign} = \frac{\sum_x^n V_{fx}}{5walls \cdot 2straps} \cdot \frac{1}{\cos(\alpha)} \quad (3-9)$$

where,

α = angle of strap with respect to horizontal

For the 1st storey,

$$T_{fdesign} = \frac{545.2kN}{5walls \cdot 2straps} \cdot \frac{1}{\cos(50.7)} = 86.1kN$$

For the example, an initial brace thickness of 1.73mm (0.068'') was selected. The minimum brace width, b, was then calculated as given by Equation 3-10. The first

step in the capacity design process (Section 2.2) was then carried out to ensure that net section fracture would not be the governing failure mode (Equation 3-11).

$$T_r = \phi A_g F_y, \text{ therefore strap width, } b \geq \frac{T_r}{\phi t F_y} \quad (3-10)$$

$$A_n R_t F_u \geq A_g R_y F_y \quad (3-11)$$

where R_y and R_t are taken as 1.5 and 1.2 respectively for 230MPa (33ksi) steels and 1.1 and 1.1 for 340MPa (50ksi) steels (*ASTM A653, 2002, AISI S213, 2007*).

This results in an initial brace width, b , of 163mm:

$$b = \frac{86.1E3}{0.9(1.73)340} = 163\text{mm} = 6.4''$$

Converting this value to inches and rounding up to the nearest half gave a strap width of 6.5” or 165mm for the first storey. This procedure was repeated for all storeys (Table 3.4, Appendix F). Stiffness irregularity requirements (2005 NBCC) were checked at all storeys and found to be adequate.

Table 3.4: Example of chosen strap sizes (6S R_dR_o2.6-minbrace)

Storey	T_{design} (kN)	F_y (MPa)	t (mm)	Strap size, b (mm)	Strap size (in)	Nominal strap size (in)
6	14.0	340	1.73	26.5	1.04	2.5
5	34.1	340	1.73	64.6	2.54	3.0
4	50.5	340	1.73	95.6	3.76	4.0
3	63.1	340	1.73	119.4	4.70	5.0
2	72.0	340	1.73	136.2	5.36	5.5
1	86.1	340	1.73	162.9	6.41	6.5

3.1.2.2. Two Brace Size Selection Criterion

The two brace size selection criterion followed the same steps as the minimum brace size selection criterion (Section 3.1.2.1). Once minimum brace sizes were

selected over the full height of the building the brace size at the first storey was used up to the third and fourth storey for the six and seven storey models, respectively. The minimum brace size selected for the subsequent level was then continued up to the roof. This criterion was not used for the two or four storey models where only the minimum brace size scenario was considered. Stiffness irregularity was then checked because the brace size changed drastically at or near the mid-height of the building. In cases where the stiffness irregularity requirement was not met (2005 NBCC, Table 4.1.8.6 (*NRCC, 2005a*)) the brace size at the building mid-height, and all storeys above, was increased accordingly. This was done in order to keep within the guidelines set out by the equivalent static force method; the intent of this exercise was to design the structures as an engineer would in practice. In all cases, it was not necessary to increase a brace size by more than half an inch in order to obtain a regular structure in terms of lateral stiffness. Selected brace sizes for all models are presented in Appendix F. Note: regardless of brace selection criterion, capacity design would need to be carried out for the remainder of the SFRS as per AISI S213.

3.1.3. *Shear Deflection*

The lateral shear deflection, or inter-storey drift, was calculated based on strap stiffness alone (Equation 3-12). No adjustment was made in the stiffness calculation to reflect the fact that lower stiffness values were obtained during testing (Section 2.11.2). This was intentionally done in keeping with the procedure that a typical designer would follow. Figure 3.5 shows a schematic of a displaced braced wall and the variables associated with this calculation. For

modeling purposes an adjusted stiffness was used; it accounted for the effect of the other elements in the SFRS as observed during testing (Section 3.2).

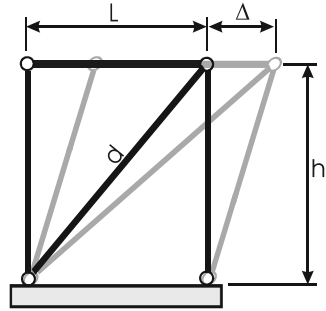

Figure 3.5: Inter-storey drift variables

$$\Delta_E = \frac{\sum_{i=x}^n F_i d_i^3}{EL^2 2A} \quad (3-12)$$

where,

$\sum_{i=x}^n F_i$ = the total design lateral load above the storey under consideration

d_i = brace length at level i

E = Young's modulus (203000MPa)

L = wall length

A = single strap cross sectional area

The first storey of the six storey example structure was found to have an elastic inter-storey drift of 10.2mm:

$$\Delta_E = \frac{109E3 \cdot 4330^3}{203000 \cdot 2740^2 \cdot 2 \cdot 285.6} = 10.2\text{mm}$$

Multiplying this drift value by the ductility and overstrength seismic force modification factors, R_d and R_o respectively, provides a total expected inelastic inter-storey drift, Δ_{mx} , of 26.5mm:

$$\Delta_{mx} = R_d R_o \Delta_1 = 2.0 \cdot 1.3 \cdot 10.2 = 26.5 \text{mm}$$

The Δ_{mx} values for all models are listed in Appendix F. The 2005 NBCC drift limit for braced steel structures is 2.5%. Converting the above inter-storey drift to percentage gives a drift of 0.8% for the 3350mm high first storey, much less than the limit:

$$\text{Drift}(\%) = \frac{\Delta_{mx}}{h_s} \cdot 100 = \frac{26.5}{3350} \cdot 100 = 0.8\% \leq 2.5\%, \text{ok}$$

The inelastic inter-storey drift was checked for all storeys of all model configurations and was found not to control design.

3.1.4. Second Order Effects (P-Δ)

P-Δ effects were calculated in accordance with sentence 4.1.8.3(8) of the 2005 NBCC Structural Commentary J (NRCC, 2005b). Equation 3-13 was used to calculate the stability factor, which is the percentage increase in load due to P-Δ effects.

$$\theta_x = \frac{\sum_{i=x}^n W_i}{R_o \sum_{i=x}^n F_i} \frac{\Delta_{mx}}{h} \quad (3-13)$$

where,

θ_x = stability factor

$\sum_{i=x}^n W_i$ = the portion of the factored dead plus live load above the storey

under consideration

The live load calculation was done assuming rigid diaphragm action, therefore the tributary area for each wall in the example was 220.2m² (Figure 3.2):

$$A = \frac{220.2 \cdot 5 \text{storeys}}{5 \text{walls}} = 220.2 \text{m}^2$$

The live load reduction factor (LLRF) (2005 NBCC Cl.4.1.5.9) was then applied (Equation 3-14).

$$\text{LLRF} = \left[0.3 + \sqrt{\frac{9.8}{A}} \right] \quad (3-14)$$

The load for the stability factor calculation (Equation 3-13), using a LLRF of 0.51 for the first storey, was found to be 739kN for the interior floors and 243kN for the roof:

$$W_{1-5} = (1.0 \times 2.87 \text{kPa} + 0.5 \times 1.9 \times 0.51) 220.2 \text{m}^2 = 739 \text{kN}$$

$$W_R = (1.0 \times 0.69 \text{kPa} + 0.25 \times 1.64 \text{kPa}) 220.2 \text{m}^2 = 243 \text{kN}$$

The sum of these loads was calculated and the stability factor of 0.04 found represented a 4% increase in lateral load:

$$\theta_x = \frac{785}{1.3 \cdot 10^9} \frac{26.4 \text{E} - 3}{3.66} = 0.04$$

P-Δ effects can be ignored if the stability factor is less than 0.10, or a 10% increase in lateral loads. This was the case for all storeys (Table 3.5) therefore second order loading did not affect the design. This was checked for all storeys in all models.

Table 3.5: Elastic inter-storey drift calculation (6S R_dR₀2.6-minbrace)

Storey	Δ_E (mm)	Δ_{mx} (mm)	Interstorey Drift (%)	W_i (kN)	θ_x
6	3.4	9.0	0.3	243	0.006
5	8.4	21.9	0.8	982	0.022
4	7.8	20.2	0.7	1721	0.025
3	7.8	20.2	0.7	2460	0.028
2	8.1	21.0	0.8	3199	0.033

3.2. Hysteresis Calibration of Braced Wall Element

The parameters of the bi-linear with slackness spring element provided by RUAUMOKO (Figure 3.6) were calibrated with the reversed cyclic test data such that the modeled behaviour of a wall matched that observed in the laboratory. Note, this hysteretic model accounts for the lateral rotation vs. deflection behaviour of the two separate sets of tensions braces in each wall.

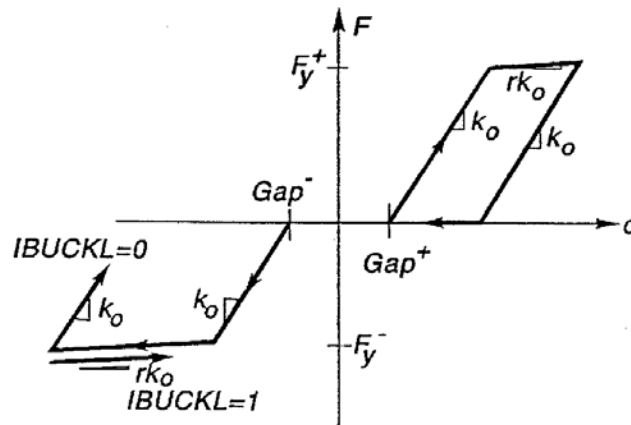

Figure 3.6: Bi-linear with slackness hysteresis (Carr, 2000)

Although the design strap sizes used in the model are not exactly the same as those used in the laboratory tests they do fall within the range covered by the light, medium and heavy walls (Chapter 2.0). The three wall configurations that

were tested in the lab exhibited a resistance vs. deformation behaviour that was consistent and predictable. For this reason it was possible to calibrate the element behaviour with the laboratory results, identify modifications that needed to be made to the calculated wall parameters, and then correctly represent the different strap sizes in the hysteretic model. Figure 3.7 shows the matching which was done using HYSTERES (Carr, 2000) (an example input file is shown in Appendix G). It can be seen that the bi-linear model element provides a resistance vs. deformation hysteretic behaviour that closely matches the experimental test result.

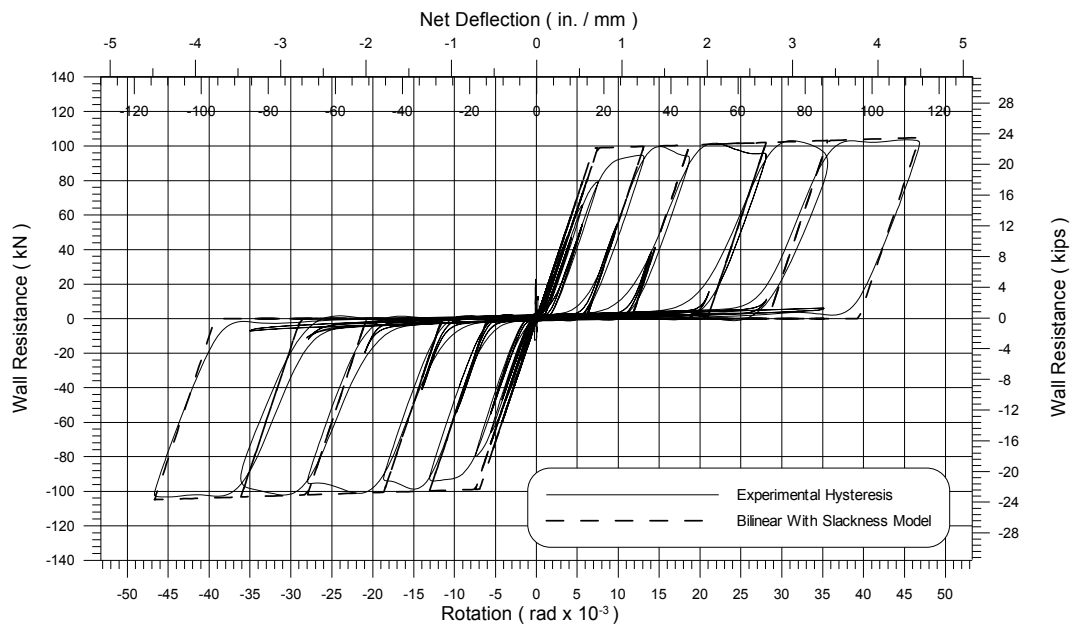

Figure 3.7: Example of matched hysteretic behaviour between model and laboratory test result 24A-C

Element calibration included choosing the elastic slope, k_0 , i.e. lateral wall stiffness, as well as the post yield slope which includes strain hardening, rk_0 . The elastic slope obtained from the test results was used in the calibration. However,

for the strap sizes used in the model buildings no test data was available; hence, a relationship was found between the predicted elastic slope and the actual elastic slope based on test results. This factor was based on the average difference between laboratory test stiffness and design stiffness, K_e and K_p , respectively (Chapter 2.0). For this calculation the medium and heavy 1: 1 wall results were used because they most closely represented the range of walls, in terms of lateral load level and brace material, which were used in the models. On average the predicted elastic slope was 20% larger than the actual elastic slope, so for the purpose of modeling all predicted elastic slopes were decreased by this amount.

The average post yield slope from the test data was used to obtain the inelastic slope in the hysteretic model. The points at the top of the loops of each yielding cycle on the reversed cyclic loading plots for the medium and heavy 1: 1 walls were considered. By using this slope, strain hardening provided by the braces was taken into account. The value of 'r' in the rk_o parameter was calculated as the elastic slope, k_o , divided by the average post yield slope based on test data. In doing this, rk_o becomes constant and independent of the brace size, as was desired. No initial slackness was considered so the variables Gap^+ and Gap^- were set to zero.

The remaining parameter, F_y , was taken as the test based yield load, S_y (Section 2.8.1), for the hysteresis matching. For modeling, the brace yield strength was calculated using the capacity design yield load, S_{yc} (Section 2.8.1). This provided

a reasonable estimate of brace yield load as was verified by analytical testing (Chapter 2.0). Input parameters for the spring element (k_o , r , and S_{yc}), for each model, are listed in Appendix F.

3.3. Development of Building Model in RUAUMOKO

A single braced bay of the example building was modeled in RUAUMOKO as a braced wall tower. It was assumed that only shear displacement of each storey would occur; flexural displacement of the lateral frame due to axial shortening and lengthening of the column members (in this case chord studs) was considered to be negligible. Each braced wall was modeled using the bi-linear spring element with strain hardening and slackness characteristics. The final brace sizes (Appendix F) were used to calculate the lateral elastic stiffness, inelastic stiffness and strength at each storey.

The simplified stick model used two linked columns to represent the braced wall system (Figure 3.8 b). Seismic masses corresponding to the tributary area of the braced frame (as per lateral loading and assuming rigid diaphragm action) were applied at each storey level. A column of infinite axial stiffness was used to account for P-Delta loading of the braced wall tower. Gravity loads were applied at each level and the corresponding nodes were slaved to the braced wall tower. The tributary area for these gravity loads was the same as that used for the seismic mass calculations. Table 3.6 contains the estimated and calculated period of vibration for the stick models.

Table 3.6: Periods of vibration for stick models

Model Name	Height, h (m)	NBCC $T_n=0.025h_n$ (s)	NBCC $2T_n$ (s) (design period)	RUAUMOKO fundamental period, T (s)	RUAUMOKO 2 nd mode period (s)	
2S	R _d R _o 2.6-minbrace	6.7	0.17	0.34	0.540	0.255
4S	R _d R _o 2.6-minbrace	12.8	0.32	0.64	0.747	0.280
6S	R _d R _o 2.6-minbrace	18.9	0.47	0.95	1.089	0.401
	R _d R _o 2.6-2brace				1.040	0.371
	R _d R _o 4-minbrace				1.286	0.466
7S	R _d R _o 2.6-minbrace	22	0.55	1.1	1.219	0.449
	R _d R _o 2.6-2brace				1.163	0.419
	R _d R _o 4-minbrace				1.456	0.538

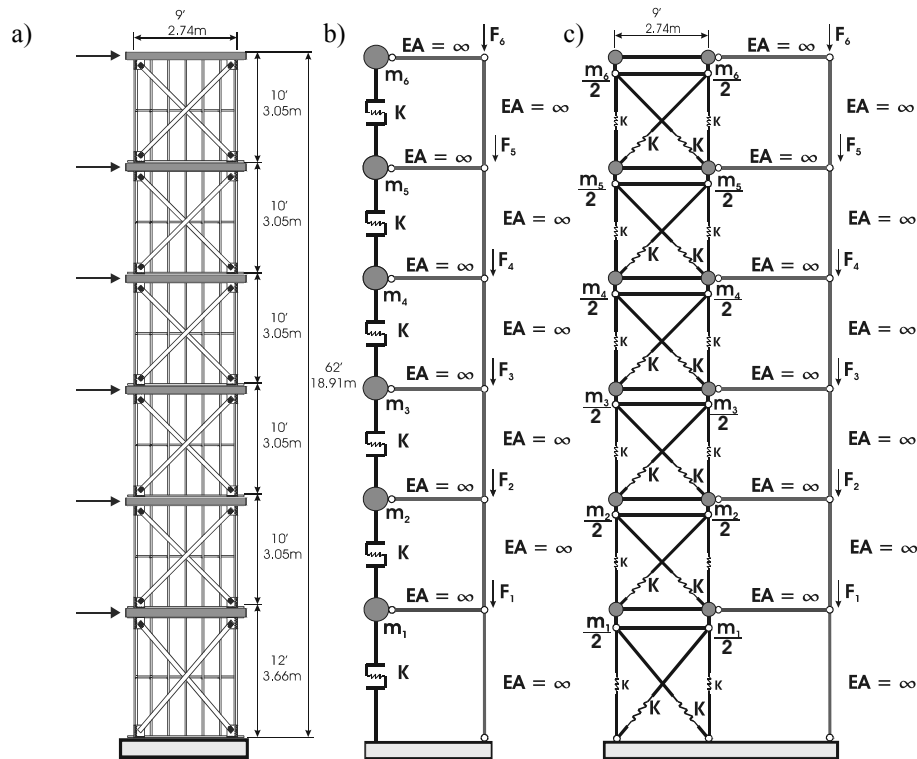

Figure 3.8: a) Schematic of a six storey shear wall tower, and layout of b) stick model and c) full brace/chord stud model

A more complex model (Figure 3.8 c)) made use of the braces in their proper inclined orientation and included chord stud members (modeled as elastic springs) whose size was selected based on the capacity approach used in design. This model was used to verify the assumption of rigid chord studs and to check the

performance of the stick model. Seismic mass' and P-Delta effects were taken to act the same as in the simpler stick model. Example RUAUMOKO input files for the six storey models are shown in Appendix G.

Model heights were chosen to represent a range of typical multi-storey CFS framed structures up to and exceeding the AISI S213 proposed height limit of 20m. The preliminary analyses included two, four, six and seven storey models, all designed as limited ductility concentrically braced frames ($R_d=2.0$, $R_o=1.3$) and using the minimum brace size selection criterion (Section 3.1.2.1). Subsequent analyses concentrated on the six and seven storey models, those just above and below the height limit. These models also incorporated $R_dR_o = 4.0$ with the minimum brace selection criterion, as well as the standard $R_dR_o = 2.6$ with the two brace selection criterion. An R_dR_o of 4.0 was used as this value is found in ASCE 7 (2005) and in the US Army Corps of Engineers Technical Instructions TI 809-07 (2003).

3.4. Ground Motion Selection and Scaling

A total of 45 ground motion records were chosen and matched to the UHS for Vancouver site class C (Table 3.7). This number was arrived at because it is in line with the 44 standard records listed in ATC-63. There were three types of records included in the complete suite of ground motions; simulated earthquakes, recorded earthquakes and a single closely matched earthquake. All chosen earthquakes were either recorded on or designed for the site class C.

Table 3.7: Summary of ground motions for Vancouver, site class C

No. ^{a,b}	Event	Magn.	Station	deg.	PGA (g)	Epicentral Distance (km)	Scaling factor, SF	Time step (s)
1	Simulated V7	6.5	-	-	0.19	27.2	3	0.005
2	Simulated V17		-	-	0.06	50.1	4	0.005
3	Simulated V25		-	-	0.13	27.2	3	0.005
4	Simulated V29		-	-	0.18	7.1	1.8	0.005
5	Simulated V30		-	-	0.20	10.7	1.8	0.005
6	Simulated V82		-	-	0.34	5	1.1	0.005
7	Simulated V100		-	-	0.41	3.5	1.3	0.005
8	Simulated V109		-	-	0.47	3.5	0.9	0.005
9	Simulated V148		-	-	0.29	5.5	1.1	0.005
10	Simulated V156		-	-	0.35	15	1	0.005
11	Simulated V161		-	-	0.38	50.1	0.7	0.005
12	Simulated V170		-	-	0.15	35.6	2	0.005
13	Simulated V179		-	-	0.17	41.2	2	0.005
14	Simulated V186		-	-	0.24	22.3	1.5	0.005
15	Simulated V188		-	-	0.17	41.1	1.8	0.005
16	Simulated V197		-	-	0.23	40.8	1.2	0.005
17	Simulated V237	7.5	-	-	0.78	1.0	0.5	0.005
18	Simulated V268		-	-	0.26	28.2	1.3	0.005
19	Simulated V305		-	-	0.28	50.1	1.3	0.005
20	Simulated V311		-	-	0.92	1.0	0.6	0.005
21	Simulated V317		-	-	1.53	7.1	0.6	0.005
22	Simulated V321		-	-	0.39	21.3	1.25	0.005
23	Simulated V326		-	-	2.62	7.1	0.25	0.005
24	Simulated V328		-	-	0.52	14.2	0.8	0.005
25	Simulated V344		-	-	1.04	9.7	0.5	0.005
26	Simulated V355		-	-	1.19	13.8	0.5	0.005
27	Simulated V363		-	-	1.32	1.0	0.4	0.005
28	Simulated V389		-	-	0.26	7.2	1.1	0.005
29	Simulated V408		-	-	0.64	8.2	0.6	0.005
30	Simulated V410		-	-	0.34	13.7	0.9	0.005
31	Simulated V411		-	-	0.36	16.5	0.9	0.005
32	Simulated V430		-	-	0.13	21.9	2.4	0.005
33	CHICHIE	7.6	TCU045	90	0.49	77.5	1.1	0.005
34	CHICHIN			0			1	0.005
35	FRULI000	6.5	Tolmezzo	0	0.33	20.2	1.5	0.005
36	FRULI270			270			1	0.005
37	HECTOR000	7.1	Hector	0	0.3	26.5	2	0.005
38	HECTOR090			90			1.4	0.005
39	KOBE000	6.9	Nishi-Akashi	0	0.51	8.7	0.8	0.01
40	KOBE090			90			1	0.01
41	KOCAELI000	7.5	Arcelik	0	0.18	53.7	3	0.005
42	KOCAELI090			90			2.8	0.005
43	MANJILL	7.4	Abbar	-	0.51	40.4	0.9	0.02
44	MANJILT			-			0.75	0.02
45	CM	-	-	-	-	-	-	0.01

^aRecords 1 to 32 are synthetic (simulated) ground motions from Atkinson (2008)

^bRecords 33 to 44 are ground motions from PEER NGA database (PEER, 2005) (ATC-63, 2008)

32 simulated earthquake records were chosen from a database made available by Atkinson (2008). Various epicentral distances were included. These site specific

earthquake time histories were obtained from a seismological model that was developed to match the 2005 NBCC UHS using the stochastic finite-fault method. Parameters such as source, path and site were validated by comparing data and predictions in data-rich regions of Canada. Chosen synthetic earthquake records for Vancouver, site class C, are divided into two groups; magnitude (M) 6.5 and 7.5 earthquakes. The spectra of the records that were selected from the database were found to provide a reasonable match to the shape of the design spectrum (Figure 3.9).

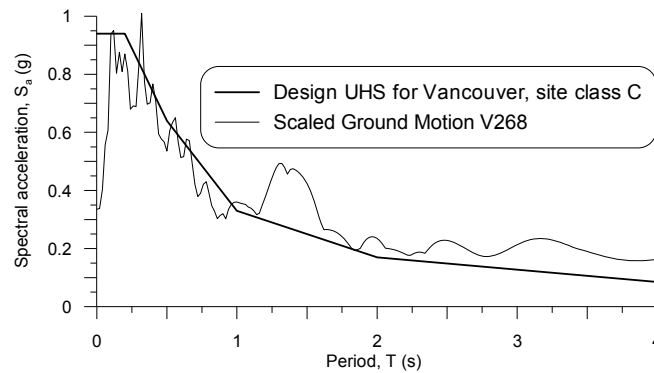

Figure 3.9: NBCC UHS used for design and example scaled synthetic earthquake record spectrum

The recorded earthquake records selected from the ATC-63 listing for the dynamic analyses were those measured at locations with site class C soil conditions. Six earthquakes were chosen, each comprising a transverse and lateral component; thus 12 recorded ground motions were incorporated in the study.

A closely matched synthetic earthquake was also used (*Léger et al., 1993*). To achieve this, an initial synthetic earthquake record is chosen. The Fast Fourier Transform (FFT) is applied and the response spectrum calculated at each

frequency. The amplitude of this response spectrum (at a given frequency) is then compared to the amplitude of the reference response spectrum (the design UHS in this case). The Fourier coefficient at each frequency is then multiplied by this ratio. This process comprises one iteration. Ten iterations were used, providing a response spectrum which closely matches the design UHS.

Scaling factors (SFs) were applied to the 44 synthetic and recorded ground motions to further improve the spectral acceleration of the record with respect to the UHS (Figure 3.9). The SFs were chosen such that the spectral acceleration of the ground motion and the UHS were approximately equal at the average fundamental period of the models. The second period of vibration was also given some consideration as to how well the synthetic record matched the UHS.

Figure 3.10 shows all the ground motion response spectra along with the design UHS. The M6.5 and M7.5 earthquakes shown on the first two plots of the figure are synthetic records taken from the Atkinson database. The recorded ground motion and the closely matched (CM) earthquake record are shown on the third plot of the figure.

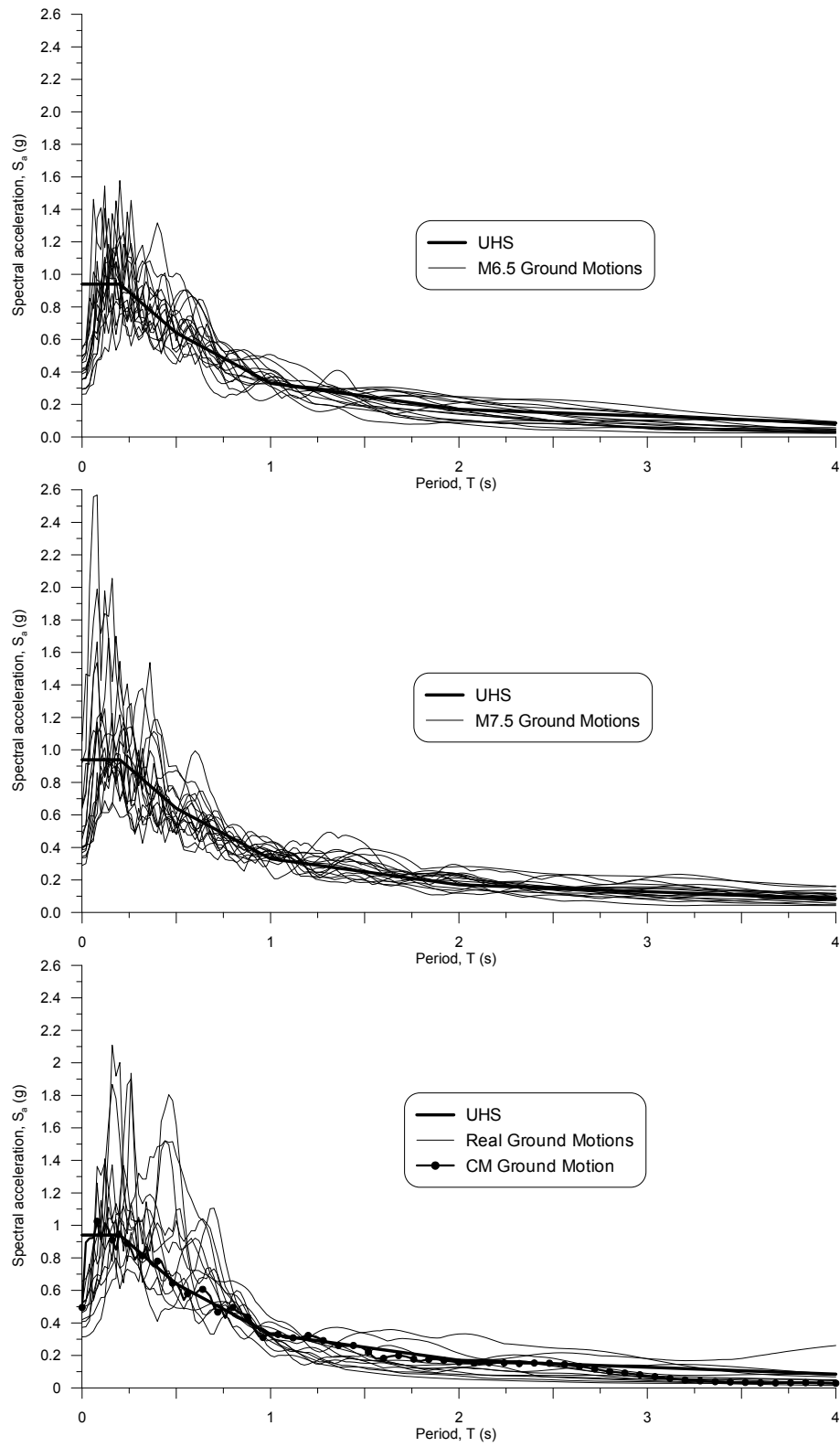

Figure 3.10: Ground motion spectra scaled to Vancouver site class C UHS

The preliminary analyses of stick models 2S $R_dR_o2.6$ -minbrace, 4S $R_dR_o2.6$ -minbrace, 6S $R_dR_o2.6$ -minbrace and 7S $R_dR_o2.6$ -minbrace, as well as the full brace/chord stud models used ground motion numbers 6, 7, 10, 18, 19, 28 and 45 as given in Table 3.7. The first six were used because of their good fit to the 2005 NBCC UHS for Vancouver as shown by Atkinson (2008) and the seventh record (number 45) is the closely matched earthquake. The inter-storey drifts from these analyses were examined and compared to acceptable and calculated drift levels (Section 3.6.2).

The final analyses (Section 3.6.3) involved the six and seven storey models and used all 45 ground motion records. The average spectral acceleration at a given period of all 45 scaled records is shown in Figure 3.11. It can be seen that the average earthquake spectrum closely follows the design UHS. The ATC-63 procedure was then used to facilitate incremental dynamic analysis and construct failure probability curves (Section 3.5).

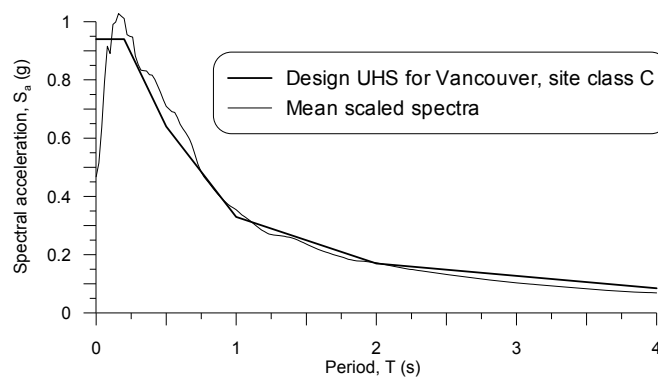

Figure 3.11: Mean scaled earthquake spectra compared to design UHS

3.5. ATC-63 Based R-Factor and Height Limit Verification

The ATC-63 procedure for verifying design R values and building system performance is a research oriented tool with a methodology that encourages the use of analytical test data. The general steps given in the procedure are described herein. To begin, the design procedure and performance requirements must be set such that the structure is able to resist earthquake loading. Background knowledge (analytical testing data) of the structural system under examination is desired at this stage.

Structural configurations to be modeled may then be decided upon and their design carried out. These configurations will vary given the range of parameters which are to be examined. The six and seven storey structures were chosen for this particular research project because they fall just below and above the building height limit of interest.

The dynamic analysis software of choice is used to develop non-linear inelastic models of each structure. All important characteristics of structural behaviour, especially stiffness and inelastic behaviour should be accounted for. Ground motion selection and scaling is done using the recommended ground motion set and hazard spectrum model period matching. Because this set is designed for buildings on American soil, synthetic ground motion records specific to the Canadian UHS were incorporated in the study. Incremental dynamic analysis

(Section 3.5.1) was run on each of the models using the scaled selected ground motions (Table 3.7).

Finally, performance evaluation of each model or group of models under the same design criterion is carried out. Collapse probability (fragility) curves are developed and adjusted to account for modeling uncertainty (Section 3.5.2). Tabulated acceptable collapse probabilities are then compared to analysis results to determine design R value and height limit acceptance.

3.5.1. Incremental Dynamic Analysis

Incremental dynamic analysis (IDA) (Vamvatsikos & Cornell, 2002) was carried out on models 6S R_dR_o2.6-minbrace, 6S R_dR_o2.6-2brace, 6S R_dR_o4-minbrace, 7S R_dR_o2.6-minbrace, 7S R_dR_o2.6-minbrace and 7S R_dR_o4-minbrace using all 45 earthquake records (Figure 3.12, Appendix I). The scaled records listed in Table 3.7 were considered as the baseline design level earthquake because of their match to the UHS. In terms of the incremental dynamic analyses these pre-scaled ground motion records were assigned a SF of 1.0. Each of the records was then scaled incrementally from 0.2 to a maximum of 6.0. The resulting earthquake records were applied to the six and seven storey building models listed above. The examined damage measure was defined as the maximum inter-storey drift for each run irrespective of the storey in which it took place. The resulting curve, SF vs. damage measure, flattens out as the SF is increased, up to a point where a small increase in SF leads to a large increase in damage measure (failure).

An inter-storey drift based failure criterion of 6.0% (Figure 3.12) reflects a minimum drift level which all 1:1 aspect ratio test specimens were able to attain without brace fracture during monotonic testing in the laboratory (Chapter 2.0).

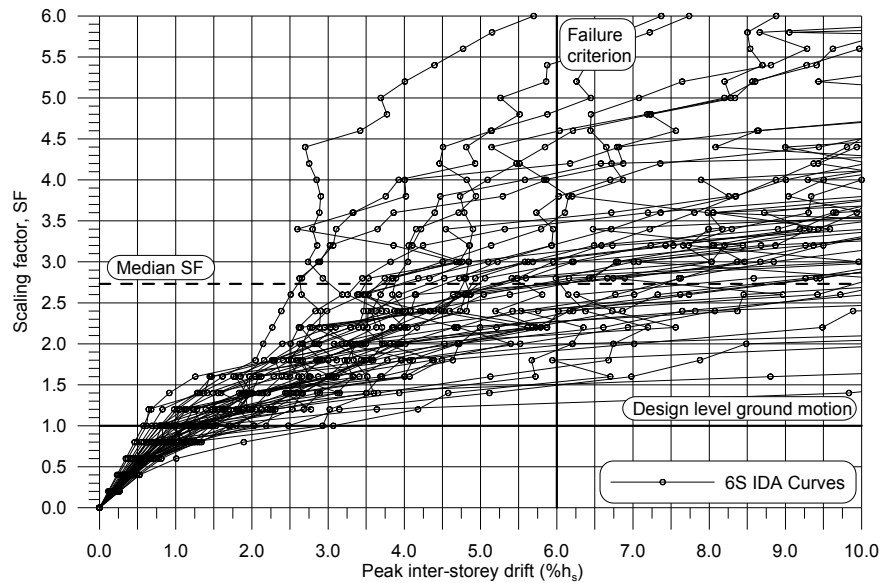

Figure 3.12: IDA curve for model 6S $R_dR_o2.6$ -minbrace

On the vertical axis of the figure, a SF of one represents the design level ground motion scaled to the 2005 NBCC UHS (Section 3.4). The SF which causes half of the input ground motions to exceed the failure criterion is the median SF (Figure 3.12). This is a value of interest when carrying out the ATC-63 evaluation procedure.

3.5.2. *Fragility Curve Development*

The fragility curve is based on the probability of failure (percentile) resulting from each input ground motion included in the IDA runs. In simple terms, it is composed of data points that represent the number of ground motion records at a particular SF which cause the building model to fail divided by the total number of records (45) used in the analyses. These probabilities were plotted vs. SF and a

lognormal distribution was fit through the points to create the fragility curve (Figure 3.13, Appendix I). This cumulative distribution function is defined by the natural logarithm of the median SF and the standard deviation of the data set, which was found through the curve fitting operation done by Grapher 7.0 (*Golden Software, 2007*). The median SF corresponds to a 50% probability of collapse (the SF which caused half of the input ground motions to have an inter-storey drift, at any storey, greater than 6.0%) while the standard deviation reflects variation in the results and controls the slope of the resulting fragility curve.

The ratio of the design level ground motion (SF equal to one) to the median SF is defined as the collapse margin ratio (CMR). To account for uncertainty within the analysis two adjustment factors are defined in the ATC-63 document; the spectral shape factor (SSF) and the total collapse uncertainty, β_{TOT} . These factors are applied to the CMR and the standard deviation of the data set and change the shape of the fragility curve.

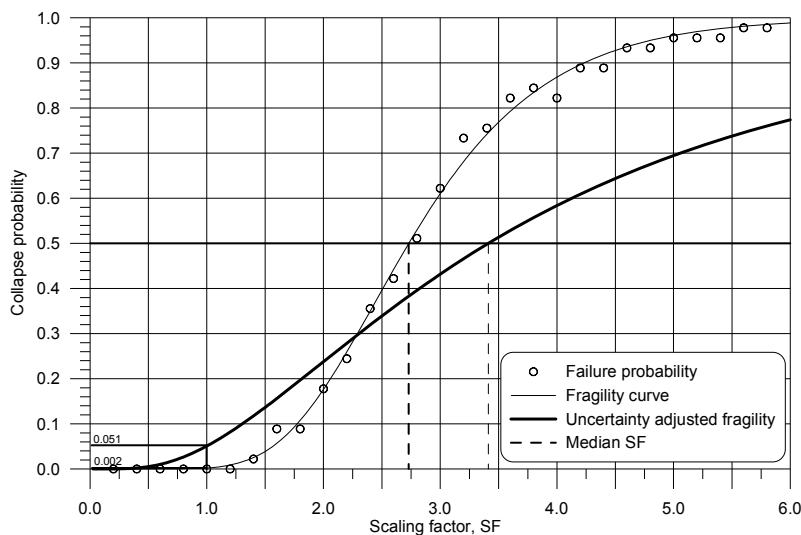

Figure 3.13: Fragility curve for model 6S RdRo2.6-minbrace

3.5.2.1. Determination of Spectral Shape Factor

The SSF is a function of the seismic design category (SDC), the ductility capacity, μ , and the fundamental period, T , and is applied directly to the CMR to give an adjusted collapse margin ratio (ACMR) (Equation 3-15). A SDC of D was assumed because this parameter is specific to ASCE/SEI 7-05, the US loading standard, and is not used for design in Canada. It is interesting to note, however, that this would be the seismic design category for Seattle, the closest American city to the design location of Vancouver.

$$\text{ACMR} = \text{SSF} \times \text{CMR} \quad (3-15)$$

The ductility for each model (Table 3.13) was calculated as the ultimate deflection, Δ_{ult} (taken at 6.0% drift, the failure criterion), over the yield deflection, Δ_y . Static pushover analyses (Figure 3.14), run using RUAUMOKO, were used to calculate Δ_y (an example input file is shown in Appendix G). The analysis used a continuous ramp loading function applied over the height of the structure.

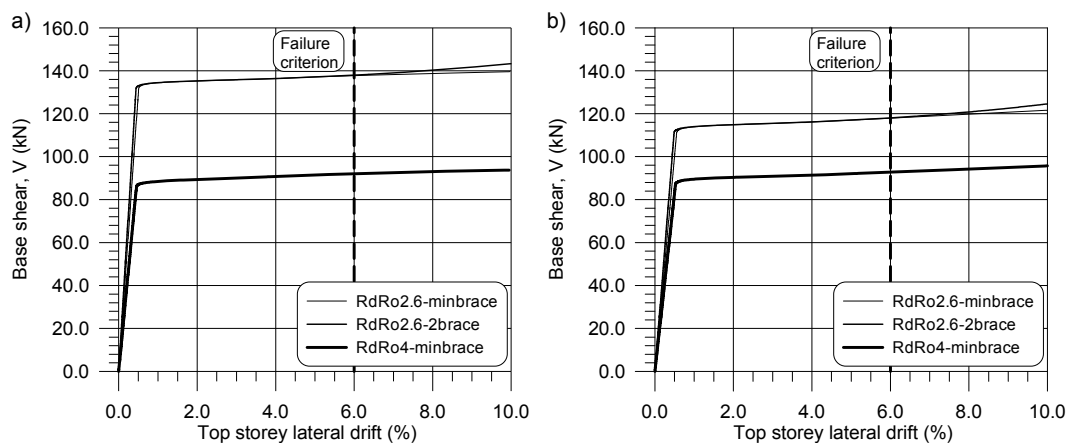

Figure 3.14: Static pushover analysis for a) six storey models, b) seven storey models

The seismic force distribution assumption given in the 2005 NBCC equivalent static force procedure was used (Figure 3.15). Seismic mass was removed for this analysis, although P-Delta effects were included. The remaining factor, the fundamental period of the structure, T , was obtained from the RUAUMOKO results for each model (Table 3.6).

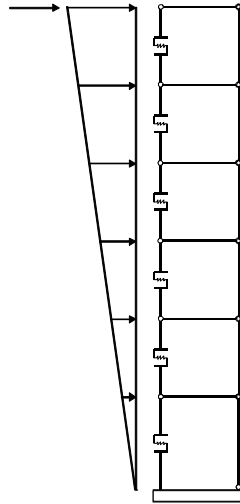

Figure 3.15: Schematic showing seismic load distribution for pushover analysis

3.5.2.2. Determination of Total System Collapse Uncertainty

The total system collapse uncertainty was calculated based on four uncertainty factors: record-to-record, design requirements, test data and modeling. These uncertainties were chosen based on the text provided within the ATC-63 procedure. Each factor is assessed as either superior ($\beta=0.20$), good ($\beta=0.30$), fair ($\beta=0.45$) or poor ($\beta=0.65$), and corresponding values assigned, with the exception of record-to-record uncertainty, which is always equal to 0.40 (Table 3.8).

The design requirements related collapse uncertainty, β_{DR} , was selected as good. Using Table 3-1 in ATC-63, the confidence in basis of design requirements was

chosen as high because evidence found through laboratory testing (Chapter 2.0) proved that the design requirements (AISI S213) lead to wall performance as intended. The completeness and robustness of medium was chosen because the design method has only been employed by this study and quality assurance requirements related to fabrication, erection and final construction with this SFRS are not fully addressed in any design documents.

Table 3.8: Determination of total system collapse uncertainty

Uncertainty factor			β
Record-to-record collapse uncertainty, β_{RTR}^a			0.40
Design requirements-related collapse uncertainty, β_{DR}			
Confidence in basis of design requirements	High	Good	0.30
Completeness and robustness	Medium		
Test data-related collapse uncertainty, β_{TD}			
Confidence in test results	High	Good	0.30
Completeness and robustness	Medium		
Modeling-related collapse uncertainty, β_{MDL}			
Accuracy and robustness of models	Medium	Fair	0.45
Structural behavioural characteristics	Moderate confidence		
Total system collapse uncertainty, β_{TOT}			0.75

^aRecord-to-record collapse uncertainty is always equal to 0.40

The test data related collapse uncertainty, β_{TD} , was selected as good (Table 3-2, ATC-63). The confidence in test results level was selected as high because it has now been well documented that if capacity design is followed and appropriate brace material is specified (as required by AISI S213), the desired behaviour of the SFRS can be achieved (*Al-Kharat & Rogers, 2006, 2007, 2008; Kim et al., 2006*). Completeness and robustness was chosen as medium because most, but not all of the general testing issues listed (ATC-63, Section 3.4.2) were adequately addressed in the test program. Deficiencies lie in the lack of inclusion of gravity loads in the test program, lack of shake table data and documented seismic event

performance. The reproducibility of construction quality in the field is also unknown because quality control measures are not part of the design requirements.

The modeling related collapse uncertainty, β_{MDL} , was selected as fair (Table 5-3, ATC-63). Structural behavioural characteristics were chosen to have a moderate confidence as the model accounts for wall performance; however it does not have collapse capabilities (drifts continue well past the failure criterion). Furthermore, modeling data from previous research with this type of system in a multi-storey setting is not available. Model accuracy and robustness was selected as medium because the model only accounts for brace yielding and does not include all wall components. A high confidence level is reserved for only the most complete and extensive models and medium is the norm.

Given the uncertainty levels for each uncertainty factor, the total system collapse uncertainty, β_{TOT} , is found (Table 7-2, ATC-63). β_{TOT} becomes the lognormal standard deviation of the uncertainty adjusted fragility curve (Figure 3.13).

Values of acceptable ACMR are given for different total system collapse uncertainties (Table 7-3, ATC-63) to compare with the analysis-found ACMR (Equation 3-15). Acceptable values of ACMR10% and ACMR20% range from 2.02 to 4.65 and 1.59 to 2.75 respectively and are based on total system collapse uncertainty and values of acceptable collapse probability of 10% and 20%. For a

given model group the acceptance criteria to evaluate the design R factor are as follows. The average ACMR must be greater than ACMR10%, and each individual model ACMR must be greater than ACMR20%.

3.6. Summary and Discussion of Analyses Results

3.6.1. Model Comparison

The six storey stick model and full brace/chord stud model were compared in order to validate the use of the stick models for the analyses. This was desired as the simpler (stick) model significantly decreases the required computing time. The seven preliminary analysis earthquake records (Section 3.4) were run on the stick model (6S R_dR_o2.6-minbrace) and three variations of the full brace/chord stud model. These variations include a model with rigid chords and a 20% reduction in design axial stiffness of the braces (most similar to the stick model, which uses a 20% reduction in shear stiffness that is based on the difference between predicted and laboratory results), and two models with sized chord studs. The first of these models included the reduced brace stiffness; the second did not. Model periods (Table 3.6, stick model and Table 3. 9, full brace/chord stud models) were close when sized chord studs were used in both the 1st and 2nd modes of vibration.

Table 3. 9: Periods of vibration for full brace/chord stud models

Model Name		Height, h (m)	NBCC T _a =0.025h _n (s)	NBCC 2T _a (s) (design period)	RUAUMOKO fundamental period, T (s)	RUAUMOKO 2 nd mode period (s)
6S	R _d R _o 2.6-minbrace full brace/chord stud model, rigid chords, 80%K	18.9	0.47	0.95	0.78	0.287
	R _d R _o 2.6-minbrace full brace/chord stud model, sized chords, 80%K				1.07	0.340
	R _d R _o 2.6-minbrace full brace/chord stud model, sized chords, 100%K				1.01	0.312

The pushover analysis (Figure 3.16 a)) showed similar stiffness and yield load between the four models. A slight decrease in overall building stiffness was seen when the sized chord studs were used, as was expected. Inter-storey drifts were also examined for comparison between the model types (Figure 3.16 b)). The conservative stick model generally provided the greatest drifts and can be considered as the worst case scenario. When sized chord studs were included in the model the result was lower drift levels. It is believed that this is caused by a combination of decreased force demand at each storey due to the presence of flexural displacements combined with the P-Delta effect, differences in the changing period of the non-linear model after yielding has taken place and differences in the Rayleigh damping coefficients associated with the more complex model.

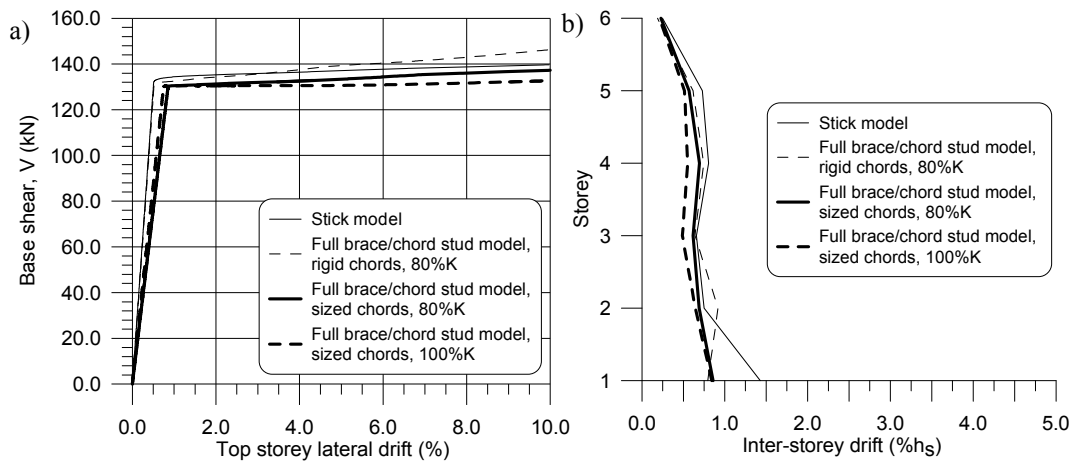

Figure 3.16: a) Pushover analysis and b) Mean Inter-storey drift comparison based on seven earthquake records for models 6S R₄R_{0.2.6}-minbrace and 6S full brace/chord stud

Example hystereses loops at each storey and time history results, and inter-storey drifts for the 45 earthquake records run on the full brace/chord stud model with sized chords and 100% of the design brace stiffness can be seen in Appendices H

and I respectively. These results show reasonable agreement between the two models and, for the most part, a conservative solution when the stick model was relied on for the analyses; therefore, the stick model was utilized to obtain the analysis results presented in Sections 3.6.2 and 3.6.3.

3.6.2. Preliminary Analyses

The preliminary analyses results, involving only 7 of the 45 ground motion records (Table 3.7), are shown in Figure 3.17 and Figure 3.18. In these plots the maximum inter-storey displacement recorded for each ground motion record are shown, expressed as percentage drift; the ratio of lateral displacement to storey height. The mean and mean plus one standard deviation (Mean+1 SD) drift levels are shown to provide an appreciation of drift variability. For these models the approximate drift at which strap yielding occurs is 0.5%, and as the plots show this is exceeded in most cases. Yielding was seen at all levels except the top storey for models 4S RdRo2.6-minbrace, 6S RdRo2.6-minbrace and 7S RdRo2.6-minbrace. This is valuable information when designing components other than the straps in the SFRS because the expected load is known (yield loads can be followed through the structure to design, for example, the first storey chord studs). Example time histories for each level in the model 6S RdRo2.6-minbrace are shown in Appendix H. Inter-storey drift plots similar to Figure 3.17 and Figure 3.18 for all six and seven storey models, using all 45 ground motion records, are presented in Appendix I. Here the result of changing design R values and brace selection criterion can be viewed. This is further discussed in Section 3.6.3.

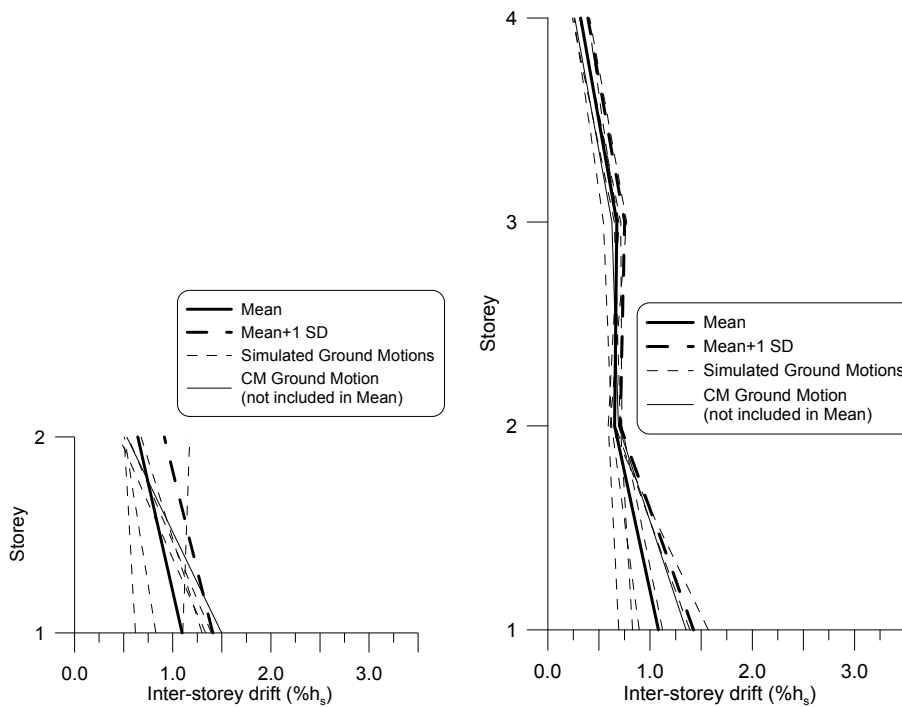

Figure 3.17: Storey height versus inter-storey drift for 2S $R_dR_o2.6$ -minbrace and 4S $R_dR_o2.6$ -minbrace models

Table 3.10 lists the maximum inelastic inter-storey drifts calculated through design and the maximum inter-storey drifts obtained from the non-linear dynamic analyses for the different height buildings. In addition, the average maximum drift for the seven earthquakes is provided. The dynamic analyses-obtained drifts were greater than the storey drifts calculated using the equivalent static force procedure ($R_dR_o\Delta_E$) (NRCC, 2005a) but still much less than the actual capability of this type of wall (approximately 6.0% drift) as seen though laboratory testing. There are two reasons for this difference.

Firstly, the design stiffness is based solely on the chosen strap size at each level, while the model stiffness has been multiplied by a factor of 0.8 (Section 3.3) to account for the lower stiffness measured during the braced wall tests. This

difference was not corrected for in the design of the buildings because an engineer would likely not be privy to the laboratory test results which were produced. This correction does, however, result in a more flexible model than the original design.

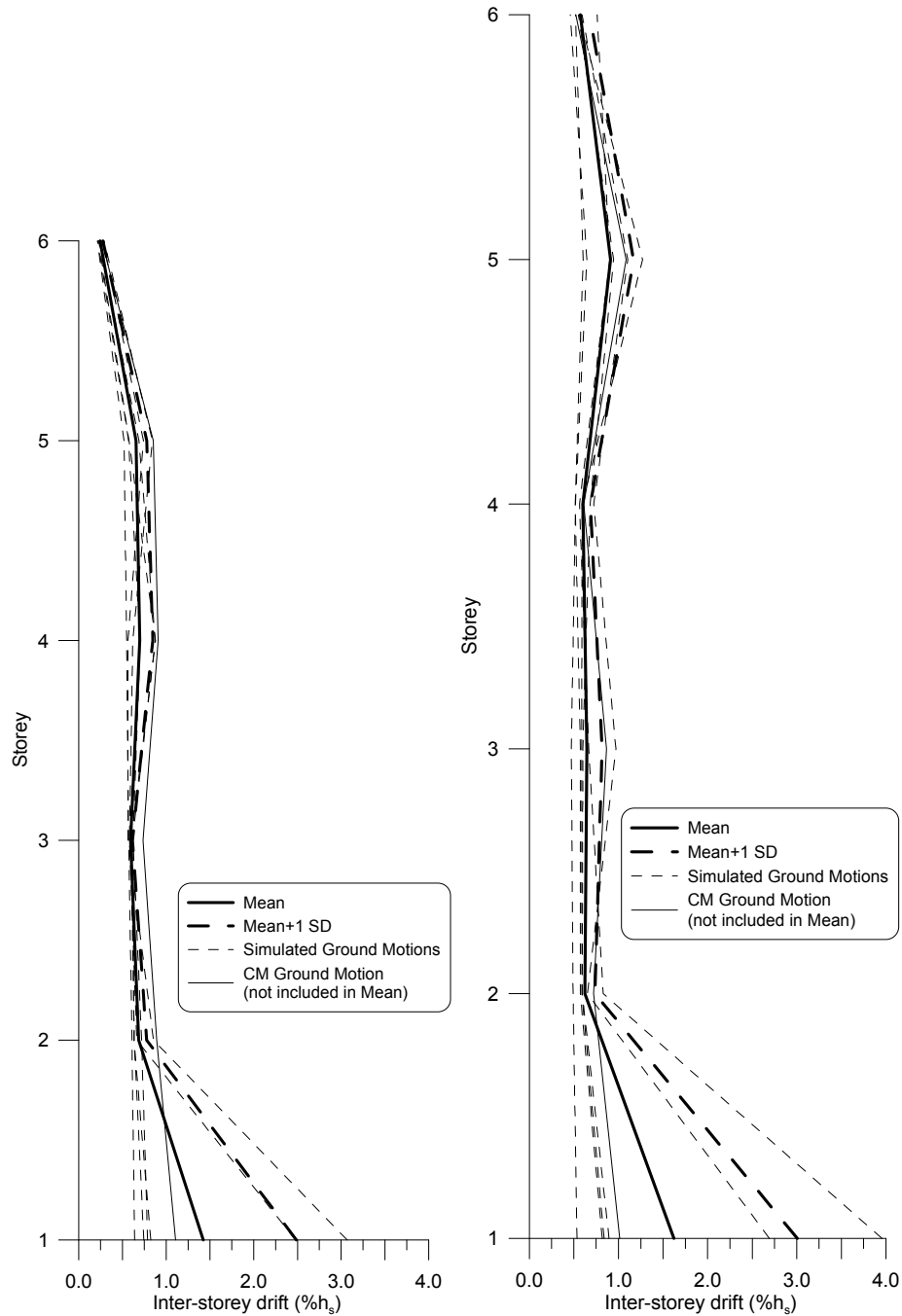

Figure 3.18: Storey height versus inter-storey drift for 6S $R_dR_o2.6$ -minbrace and 7S $R_dR_o2.6$ -minbrace models

The second reason relates to the non-linear analysis and the scaled ground motion records. During time history analysis the model period changes due to the induced non-linearity. Once first yielding has occurred the elastic period is no longer valid. The chosen earthquake records have been scaled to coincide with the elastic structure period at the design level UHS. Because the scaled earthquake records may not match the UHS at other periods, the structural response could be inadvertently amplified (the reverse is also true). These effects are difficult to quantify because the inelastic structure period changes at every time step when yielding is taking place.

Table 3.10: Inter-storey drift based on the seven earthquake records

Model Name		Height, h (m)	$R_d R_o \Delta_E$ design ^a (%)	Δ_{max} RUAUMOKO and corresponding EQ record (%)		$\Delta_{average}$ RUAUMOKO (%)
2S	$R_d R_o 2.6$ -minbrace	6.7	0.78	1.50	CM	1.16
4S	$R_d R_o 2.6$ -minbrace	12.8	0.81	1.57	V305	1.12
6S	$R_d R_o 2.6$ -minbrace	18.9	0.79	3.07	V305	1.40
7S	$R_d R_o 2.6$ -minbrace	22.0	0.80	3.96	V305	1.63

^a $R_d R_o \Delta_E$ design based on strap brace stiffness only, $R_d=2.0$, $R_o=1.3$

Models at the two and four storey height were not examined further as they performed within acceptable laboratory-based drifts. A more extensive analysis was done on the six and seven storey structures because their heights surround the AISI S213 height limit.

3.6.3. Final Analyses

The final analyses included the six and seven storey models and comprised over 8100 runs of the RUAUMOKO software. Median and maximum inter-storey drifts at each level are shown in Table 3.11 and Table 3.12. These numbers are

based on all 45 of the chosen ground motions and allow for comparison between models.

Table 3.11: Median and maximum inter-storey drifts for six storey models

Storey	Inter-storey drift (%)					
	R _d R _o 2.6-minbrace		R _d R _o 4-minbrace		R _d R _o 2.6-2brace	
	Median	Max	Median	Max	Median	Max
6	0.25	0.37	0.23	0.28	0.17	0.21
5	0.72	2.93	0.93	2.54	0.48	0.57
4	0.86	2.19	0.66	1.82	0.76	1.77
3	0.64	1.01	0.86	1.51	0.58	0.67
2	0.72	1.23	0.85	2.93	0.62	0.81
1	0.93	3.07	1.27	8.64	1.37	3.80

Table 3.12: Median and maximum inter-storey drifts for seven storey models

Storey	Inter-storey drift (%)					
	R _d R _o 2.6-minbrace		R _d R _o 4-minbrace		R _d R _o 2.6-2brace	
	Median	Max	Median	Max	Median	Max
7	0.16	0.18	0.22	0.25	0.16	0.21
6	0.55	1.97	0.73	2.22	0.46	0.56
5	1.40	3.64	1.42	3.06	0.75	2.50
4	0.51	0.90	0.60	0.89	0.51	0.61
3	0.63	2.28	0.65	1.29	0.57	0.78
2	0.65	2.91	0.60	0.88	0.59	0.70
1	0.91	5.10	1.62	- ^a	1.33	4.55

^a - indicates collapse

It can be seen that in all cases the R_dR_o = 4 design was more flexible than the R_dR_o = 2.6 models, allowing for higher inter-storey drifts under the same set of input earthquakes. For the two brace selection criteria, the contrast in drifts at levels where the brace size changes was apparent. The change in brace size at the fourth storey (six storey high model) and the fifth storey (seven storey high model) was clearly seen. It was concluded that changing stiffness creates a soft storey at the respective level resulting in much higher drift than the levels above or below. This effect is visible on the plots in Appendix I, where maximum inter-

storey drift is shown for each of the models, for each input ground motion, over model height. The soft storey effect did not allow for brace yielding and therefore energy dissipation at other storeys. Despite this, the system was able to handle concentrated yielding storeys. Median inter-storey drifts were all within the acceptable level (<6.0%) as based on analytical testing results (Chapter 2.0).

To assess the appropriateness of the R factors used in design collapse fragility curves were calculated (Figure 3.19) based on the IDA results (Appendix I). The median SFs are shown as a dashed line and correspond to the CMRs.

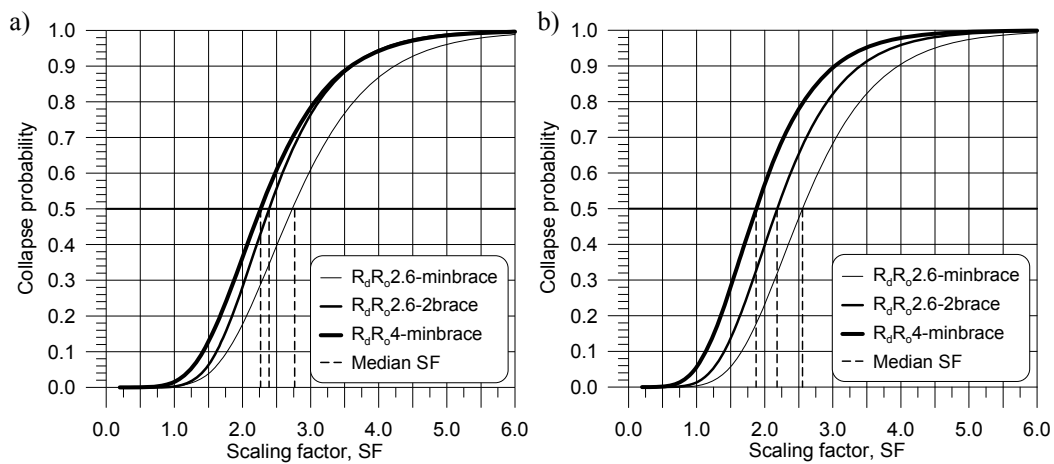

Figure 3.19: Fragility curves for a) six storey models, and b) seven storey models

Calculated structure ductility (Table 3.13) was found to be greater than 8.0, the largest value given in Table 7-1a (*ATC-63, 2008*) for choosing a SSF. It is also interesting to note that when ductility results from laboratory testing were calculated for 6.0% drift, they gave single storey ductilities greater than 8.0.

The uncertainty adjusted curves for ductility greater than 8.0 are shown in (Figure 3.20). Individual fragility curves with the adjusted fragility are shown in Appendix I.

Table 3.13: Parameters for determining model acceptance

Group No.	Model Name		Ductility, μ^a	SSP ^b	β_{TOT}^b	CMR	ACMR	Acceptable ACMR10% ^c	Acceptable ACMR20% ^c
1	6S	R _d R _o 2.6-minbrace	11.5	1.25	0.75	2.73	3.41	2.61	1.88
	7S	R _d R _o 2.6-minbrace	10.6	1.3		2.56	3.32		
2	6S	R _d R _o 2.6-2brace	13.2	1.25		2.39	2.99		
	7S	R _d R _o 2.6-2brace	12.0	1.3		2.18	2.84		
3	6S	R _d R _o 4-minbrace	13.4	1.3		2.27	2.95		
	7S	R _d R _o 4-minbrace	11.2	1.35		1.87	2.53		

^aCalculated based on pushover analysis results at 6.0% drift, $\mu = \Delta_{6.0\%} / \Delta_y$

^bCalculated as per Section 3.5.2

^cAcceptable ACMR values from Table 7-3 in ATC-63 document

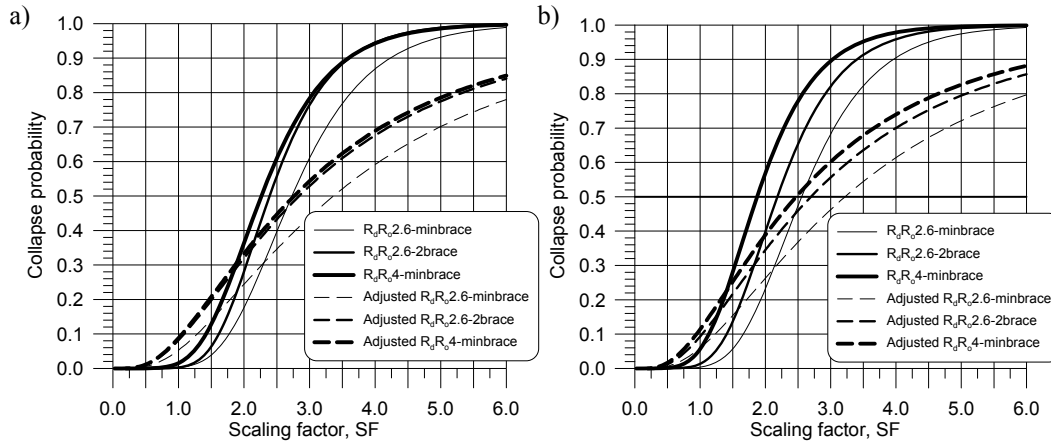

Figure 3.20: Uncertainty adjusted fragility curves for a) six storey models and b) seven storey models

Acceptance criteria for R values given in ATC-63 states that the average ACMR for the group of models must exceed the ACMR10% value and that individual models must exceed the ACMR20% (Table 3.13). The six models were divided into three groups according to the design R factor and the brace selection criterion, as shown in the table. It was found that all the models are satisfactory and R values of 2.6 and 4 are acceptable at the current building height limit of

20m listed in AISI S213. Group number 3 was very close to the limit, with an average ACMR of 2.74, slightly greater than the acceptable ACMR 10% (2.61). Further analysis is recommended, however, using more model variations to further prove the result. The ATC-63 recommends the use of twenty to thirty specific structural configurations per group and resources were not available to complete this volume of analyses.

Failure probabilities at the design level ground motion (SF=1.0) were also examined (Table 3.14, fragility curve plots in Appendix I). Similar to the ACMR comparison above, only the group 3 seven storey model had a failure probability greater than 10%, but again the group average is less than 10% (the lower limit used in ATC-63) and the design parameters are therefore adequate.

Table 3.14: Failure probabilities at design level ground motion

Group No.	Model Name		Failure probability at design level GM (%)	
			Analysis result	Adjusted for uncertainty
1	6S	R _d R _o 2.6-minbrace	0.2	5.1
	7S	R _d R _o 2.6-minbrace	0.4	5.4
2	6S	R _d R _o 2.6-2brace	0.2	7.2
	7S	R _d R _o 2.6-2brace	1.3	8.2
3	6S	R _d R _o 4-minbrace	1.5	7.5
	7S	R _d R _o 4-minbrace	5.7	10.8

3.6.4. General Discussion

Although the ATC-63 method recommends the use of more structural configurations, the results of the IDA analyses documented herein are encouraging. The AISI S213 R factor models (groups 1 and 2) calibrated to laboratory test results performed within acceptable limits as defined by the ATC-

63 thereby verifying the design method at the prescribed height limit. When the R factor was increased to 4.0 the models were also adequate.

The adjustments for uncertainties of the fragility curve (Section 3.5.2.2) are based on text given in ATC-63 and are subject to interpretation. Efforts to make conservative choices were made; however, it is possible that another user may come to a different result. This being said most of the models were well within the range of acceptable failure probabilities so some allowance for error is present.

Analysis results showed no presence of the concentration of demand in a single storey (soft storey effects) for the minimum brace size selection criterion. Soft storey effects were seen to limit inelastic behaviour to only two storeys when the two brace selection criterion was used. Despite this, the group two models were still able to dissipate energy with out collapse. Only a slight increase in failure probability was seen therefore this design criterion was also deemed valid.

4.0 CONCLUSIONS AND RECOMMENDATIONS

4.1. Conclusions

4.1.1. *Test Program*

During the summer of 2007 thirty tests of single storey weld connected strap braced cold-formed steel walls were carried out at McGill University. These tests were a continuation of previous research by Al-Kharat & Rogers (2006, 2008). Monotonic and reversed cyclic loading protocols were used to evaluate the AISI S213 (2007) proposed design method for limited ductility concentrically braced frames (capacity design, R_y and R_t factors) and overall seismic performance. Three design lateral load levels and three wall aspect ratios were examined.

It was found that the AISI S213 capacity design procedure and material requirements allowed for the desired ductile wall performance (yielding of the braces) to develop in the 1:1 and 1:2 aspect ratio walls. Walls with aspect ratios of 1:4 were observed to be significantly more flexible than the longer walls; furthermore, they were not able to maintain their yield capacity under lateral loading due to premature compression / flexure failure of the chord studs. At this stage, the use of strap braced walls with aspect ratios of 1:4 is not recommended. Welded connections performed as expected and are therefore verified for use as described in the AISI S213 capacity design procedure. The designer is cautioned, however, that care in the specification and implementation of the welding procedure must be taken because the strap connection is a critical part of the SFRS. The weld connections need to be properly designed and fabricated to

ensure ductile inelastic performance of the braced wall under seismic loading. The AISI S213 material specific R_y and R_t factors gave good estimates of the actual material strength for the two steel grades used and are recommended for use in capacity design. Screw holes through strap braces at interior stud locations had no effect on wall performance. The AISI S213 requirement for the ratio $F_u/F_y \geq 1.2$ of the brace is therefore adequate for this material.

4.1.2. *Dynamic Analysis*

Dynamic analysis was used to determine the appropriateness of the proposed AISI S213 Canadian adopted seismic force modification (R) factors ($R_d = 2.0$, $R_o = 1.3$) and building height limit of 20m for a limited ductility strap braced wall system. Initially, inter-storey drifts were examined, followed by the use of the ATC-63 (2008) procedure for determining the validity of R factors (incorporating IDA and collapse fragility curves). Various designs and configurations of the example structure located in Vancouver, BC, Canada (site class C) were modeled using a non-linear dynamic shear model with the RUAUMOKO software (Carr, 2000). This model was checked against a more complex version, which directly accounted for the braces and chord studs, and proved to be adequate. The input suite of earthquake records, scaled to the 2005 NBCC (NRCC, 2005a) UHS for this location, included 45 time histories comprising both synthetic and recorded ground motions. The structures were all designed using the 2005 NBCC equivalent static force procedure as per the procedure a practicing engineer would likely follow. Design variations included brace selection criteria as well as $R_d R_o$ factors.

When the minimum brace selection criterion was used (most economical brace size at each storey), no soft storey effects were seen; brace yielding was present at every storey except the roof. With the two-brace selection criterion (brace size changes only once over the height of the structure) concentration of inter-storey drifts was seen. In this case, the drifts did not exceed acceptable limits as defined by testing and adequate energy dissipation without collapse was still present.

The ATC-63 design procedure showed that each group (models above and below the AISI S213 height limit with different design criteria) was able to perform within acceptable failure probabilities given the input earthquake record set. This confirms that the AISI S213 height limit and R factors are valid for design of the limited ductility system. Models designed with combined $R_d R_o = 4.0$ also performed satisfactory under the ATC-63 method therefore confirming that a seismic force reduction factor of this magnitude may be acceptable for design.

4.2. Recommendations for Future Studies

Deficiencies from the laboratory testing section lie in the prediction of lateral wall stiffness and the 1:4 aspect ratio walls. Investigation is needed into the components which contribute to wall stiffness and how to best represent them for design purposes. The 1:4 aspect ratio walls need to be designed to avoid failure of the chord studs. End moments due to the stiff gusset plate connection, combined with wall flexibility may have contributed to a decrease in the axial/flexural capacity of the chord studs and their eventual premature failure.

Though the results show that the AISI S213 R_y and R_t factors work well together and are applicable for design, a material testing based study may be warranted to further verify their values. It was found that R_y may underestimate probable design forces when they are compared to dynamic test data, which could, though it did not in the case of these tests, lead to premature failure of a wall component under capacity design. Recommendations for a revised R_y factor based on this research were not possible as only three different braces were used (a very small sample size).

Dynamic shake table testing is needed to further assess wall performance. Kim et al. (2007) noted that the effect of impact loading due to the inherent slackness in the system between loading cycles after brace yielding cannot be quantified with displacement controlled tests. Although Filiatrault & Tremblay (1998) concluded that this effect was not of concern for hot rolled steel braced structures, it has not been assessed for CFS walls. Furthermore, dynamic shake table tests of multi-storey structures are needed to verify and further improve structural models used for dynamic analysis and to establish that this SFRS should be included in the seismic provisions of the NBCC.

The dynamic analysis documented herein used only a simple, symmetrical structure and shear model. Seismic risk was only assessed for one region of the country. In order to further confirm the findings, more complex designs and models should be evaluated for many regions of Canada. This is in keeping with the ATC-63 guidelines where it is recommended that twenty to thirty models be designed in each group. These further investigations should be completed before CFS shear force resisting systems are introduced into the NBCC.

REFERENCES

- Adham, S.A., Avanesian, V., Hart, G.C., Anderson R.W., Elmlinger, J., Gregory, J. (1990). "Shear Wall Resistance of Lightgauge Steel Stud Wall Systems", *Earthquake Spectra*, 6:1, 1-14.
- Al-Kharat, M., Rogers, C.A., (2008) "Inelastic Performance of Screw Connected Cold-Formed Steel Strap Braced Walls", *Canadian Journal of Civil Engineering*, Vol. 35 No. 1, 11-26.
- Al-Kharat, M., Rogers, C.A. (2007). "Inelastic Performance of Cold-Formed Steel Strap Braced Walls", *Journal of Constructional Steel Research*, Vol. 63 No. 4, 460-474.
- Al-Kharat, M., Rogers, C.A., (2006). "Inelastic Performance of Screw Connected Light Gauge Steel Strap Braced walls", Research Report, Dept. of Civil Engineering & Applied Mechanics, McGill University, Montreal, QC, Canada.
- Al-Kharat, M., Rogers, C.A. (2005). "Testing of Light Gauge Steel Strap Braced Walls", Research Report, Dept. of Civil Engineering & Applied Mechanics, McGill University, Montreal, QC, Canada.
- American Iron and Steel Institute (2007). "AISI S213-07, North American Standard for Cold-Formed Steel Framing – Lateral Design", Washington DC, USA.
- American Society of Civil Engineers ASCE/SEI 7-05 (2005). "Minimum Design Loads for Buildings and Other Structures", Reston, VA, USA.
- American Society for Testing and Materials A193/A193M (2006). "Standard Specification for Alloy-Steel and Stainless Steel Bolting Materials for High Temperature or High Pressure Service and Other Special Purpose Applications", West Conshohocken, PA, USA.
- American Society for Testing and Materials A325 (2002). "Standard Specification for Structural Bolts, Steel, Heat Treated 120/105 ksi Minimum Tensile Strength", West Conshohocken, PA, USA.
- American Society for Testing and Materials A370 (2002). "Standard Test Methods and Definitions for Mechanical Testing of Steel Products", West Conshohocken, PA, USA.
- American Society for Testing and Materials A653 (2002). "Standard Specification for Steel Sheet, Zinc-Coated (Galvanized) or Zinc-Iron Alloy-Coated (Galvannealed) by the Hot-Dip Process", West Conshohocken, PA, USA.
- American Society for Testing and Materials E2126 (2005). "Standard Test Methods for Cyclic (Reversed) Load Test for Shear Resistance of Framed Walls for Buildings" West Conshohocken, PA, USA.
- ANSYS (1994). Swanson Analysis Systems Inc. (SASI), Houston, PA, USA.

- Applied Technology Council (2008). “Quantification of Building Seismic Performance Factors, ATC-63 Project Report - 90% Draft” Redwood City, CA, USA.
- Atkinson, G. M. (2008). “Earthquake Time Histories Compatible with the 2005 NBCC Uniform Hazard Spectrum”, *Canadian Journal of Civil Engineering*, In press.
- Barton, A.D. (1997). “Performance of Steel Framed Domestic Structures Subject to Earthquake Loads”. PhD Thesis, Department of Civil and Environmental Engineering, University of Melbourne, Melbourne, Australia.
- Blais, C. (2006). “Testing and Analysis of Light Gauge Steel Frame / 9mm OSB Wood Panel Shear Walls”. M.Eng Thesis, Dept. of Civil Engineering & Applied Mechanics, McGill University, Montreal, QC, Canada.
- Boudreault, F.A., Blais, C., Rogers, C.A. (2007) "Seismic force modification factors for light-gauge steel-frame – wood structural panel shear walls", *Canadian Journal of Civil Engineering*, Vol. 34 No. 1, 56-65
- Branston, A.E., Chen, C.Y., Boudreault, F.A., Rogers, C.A. (2006) "Testing of Light-Gauge Steel-Frame – Wood Structural Panel Shear Walls", *Canadian Journal of Civil Engineering*, Vol. 33 No. 5, 561-572.
- Canadian Institute of Steel Construction (2004). “Handbook of Steel Construction”, 8th edition, Toronto, ON, Canada.
- Canadian Standards Association S16 (2005). “Limit States Design of Steel Structures”, Mississauga, ON, Canada.
- Canadian Standards Association S136 (2007). “North American Specification for the Design of Cold-Formed Steel Structural Members”, Mississauga, ON, Canada.
- Canadian Welding Bureau (2005). “Welding for Design Engineers”, Mississauga, ON, Canada.
- Canam Group (2004). “Hambro D500 floor system”, www.hambrosystems.com.
- Carr, A. J. (2000). “RUAUMOKO – Inelastic Dynamic Analysis, Version March 15th 2000”, Department of Civil Engineering, University of Canterbury, Christchurch, New Zealand.
- Casafont, M., Arnedo, A., Roure, F., Rodríguez-Ferran, A. (2006). “Experimental Testing of Joints for Seismic Design of Lightweight Structures. Part 1. Screwed Joints in Straps”, *Thin-Walled Structures*, 44, 197-210.
- Cobeen, K., Van de Lindt, J. W., Cronin, K. (2007). “Design of a Six-Story Woodframe Building based on the 2006 IBC Methodology”, NEESwood report NW-03, In press.

- Cronatron Welding Systems Inc. (2003) “Cromomig 321M Specifications” <http://webapp1.cronatronwelding.com/cronatron/homePage>. Accessed November, 2007.
- Della Corte, G., Landolfo, R., Fiorino, L. (2006). “Seismic Behaviour of Sheathed Cold-Formed Structures: Numerical Tests”, *Journal of Structural Engineering, ASCE*, 132:4, 558-569.
- Filiatrault, A., Tremblay, R. (1998). “Design of Tension-Only Concentrically Braced Steel Frames for Seismic Induced Impact Loading”, *Engineering Structures*, 20: 12, 1087-1096.
- Fülöp, L.A., Dubina, D. (2004a). “Performance of Wall-Stud Cold-Formed Shear Panels Under Monotonic and Cyclic Loading. Part I: Experimental Research”, *Thin-Walled Structures*, 42, 321-338.
- Fülöp, L. A., Dubina, D. (2004b). “Performance of Wall-Stud Cold-Formed Shear Panels Under Monotonic and Cyclic Loading. Part II: Numerical Modeling and Performance Analysis”, *Thin-Walled Structures*, 42, 339-349.
- Gad, E.F., Chandler, A.M., Duffield, C.F., Hutchinson, G.L. (1999a). “Earthquake Ductility and Overstrength in Residential Structures”, *Journal of Structural Engineering and Mechanics*, 8:4, 361-382.
- Gad, E.F., Duffield, C.F., Hutchinson, G.L, Mansell, D.S., Stark, G. (1999b). “Lateral Performance of Cold-Formed Steel-Framed Domestic Structures”, *Journal of Engineering Structures*, 21, 83-95.
- Gad, E.F., Chandler, A.M., Duffield, C.F., Stark, G. (1999c). “Lateral Behaviour of Plasterboard-Clad Residential Steel Frames”, *Journal of Structural Engineering, ASCE*, 125:1, 32-39.
- Golden Software, Inc. (2007). “Grapher – Version 7.0.1870” Golden, CO, USA
- Hatami, S., Ronagh, H. R., Azhari, M. (2008). “Behaviour of Thin Strap-Braced Cold-Formed Steel Frames Under Cyclic Loads”, *Fifth International Conference on Thin-Walled Structures*, Brisbane, Australia, Vol. 1, 363-370.
- Hikita, K. E. (2006). “Impact of Gravity Loads on the Lateral Performance of Light Gauge Steel Frame / Wood Panel Shear Walls”, M.Eng. Thesis, Dept. of Civil Engineering & Applied Mechanics, McGill University, Montreal, Canada.
- Kim, T.-W., Wilcoski, J., Foutch, D. A., (2007) “Analysis of Measured and Calculated Response of a Cold-formed Steel Shear Panel Structure”, *Journal of Earthquake Engineering*, 11:1, 67–85.
- Kim, T.-W., Wilcoski, J., Foutch, D. A., Sung Lee, M. (2006). “Shaketable tests of a cold-formed steel shear pane”, *Engineering Structures*, Vol. 28, No. 10, 1462-1470.

- Krawinkler, H., Parisi, F., Ibarra, L., Ayoub, A., Medina, R. (2000). “Development of a Testing Protocol for Woodframe Structures”, Report W-02 covering Task 1.3.2, CUREE/Caltech Woodframe Project. Consortium of Universities for Research in Earthquake Engineering (CUREE), Richmond, CA, USA.
- Léger, P., Tayebi, A. K., Paultre, P. (1993). “Spectrum-compatible Accelerograms for Inelastic Seismic Analysis of Short-period Structures located in eastern Canada”, *Canadian Journal of Civil Engineering*, Vol. 20, 951-968.
- McCreeless, D., Tarpy, T. S. (1978). “Experimental Investigation of Steel Stud Shear Wall Diaphragms”, *Proc., Fourth International Specialty Conference on Cold-Formed Steel Structures*, St-Louis, MO, USA, 647-672.
- Mitchell, D., Tremblay, R., Karacabeyli, E., Paultre, P., Saatcioglu, M., Anderson, D. L. (2003). “Seismic Force Modification Factors for the Proposed 2005 Edition of the National Building Code of Canada”, *Canadian Journal of Civil Engineering*, Vol. 30, No. 2, 308-327.
- National Research Council of Canada (2005a). “National Building Code of Canada 2005”, 12th Edition, Ottawa, On, Canada.
- National Research Council of Canada (2005b). “User’s Guide – NBC 2005 Structural Commentaries (Part 4 of Division B)”, 2nd Edition, Ottawa, On, Canada.
- Newmark, N. M., Hall, W. J. (1982). “Earthquake Spectra and Design”, Engineering Monograph MNO-3, Earthquake Engineering Research Institute, Berkeley, CA, USA.
- Park, R. (1989). “Evaluation of Ductility of Structures and Structural Assemblages from Laboratory Testing”. Bulletin of the New Zealand National Society for Earthquake Engineering, 22:3.
- Pastor, N., Rodríguez-Ferran, A. (2005). “Hysteretic Modelling of X-Braced Shear Walls”, *Thin-Walled Structures*, 43, 1567-1588.
- Pacific Earthquake Engineering Research Center (PEER) (2005). “PEER NGA database”, <http://peer.berkeley.edu/nga>. Accessed March, 2008.
- Prakash, V., Powell, G. H., Campbell, S. (1994) “DRAIN-3DX Base Program Description and User Guide”, Version 1.10. Department of Civil Engineering, University of California, Berkeley, CA, USA.
- Prakash, V., Powell, G. H., and Campbell, S. (1993) “DRAIN-2DX Base Program Description and User Guide”, Version 1.10, Report no. UCB/SEMM-93/17 and 93/18, Department of Civil Engineering, University of California, Berkeley, CA, USA.
- Serrette, R., Ogunfunmi, K. (1996) “Shear Resistance of Gypsum-Sheathed Light-Gauge Steel Stud Walls”, *Journal of Structural Engineering, ASCE*, 122:4, 383-389.

- Simpson Strong-Tie Co., Inc. (2005) "S/HDS & S/HDB Holdowns Specification"
Catalog C-CFS06, Pleasanton, CA, USA. 23.
- Tarpy, T. S., Hauenstein, S. F. (1978). "Effect of Construction Details on Shear Resistance of Steel-Stud Wall Panels", Project No. 1201-412 sponsored by AISI, Department of Civil Engineering, Vanderbilt University, Nashville, TN, USA
- TI 809-07 (2003), "Technical instructions : Design of cold-formed loadbearing steel systems and masonry veneer / steel stud walls", US Army Corps of Engineers, Engineering and Construction Division, Directorate of Civil Works, Washington DC, USA.
- Tian, Y.S., Wang, J., Lu, T.J. (2004) "Racking Strength and Stiffness of Cold-Formed Steel Wall Frames", *Journal of Constructional Steel Research*, 60, 1069-1093.
- Tremblay, R., Filiatrault, A. (1996). "Seismic impact loading in inelastic tension-only concentrically braced steel frames: myth or reality?", *Earthquake Engineering and Structural Dynamics*, 25: 1373-1389.
- Vamvatsikos D., Cornell, C. A. (2002) "Incremental Dynamic Analysis", *Earthquake Engineering and Structural Dynamics*, 31:4, 491-514.
- Whitmore, R.E. (1952) "Experimental Investigation of Stresses in Gusset Plates"
The University of Tennessee Engineering Experiment Station, Knoxville TN, Bulletin No. 16.

Appendix A

Individual Test Results Summaries

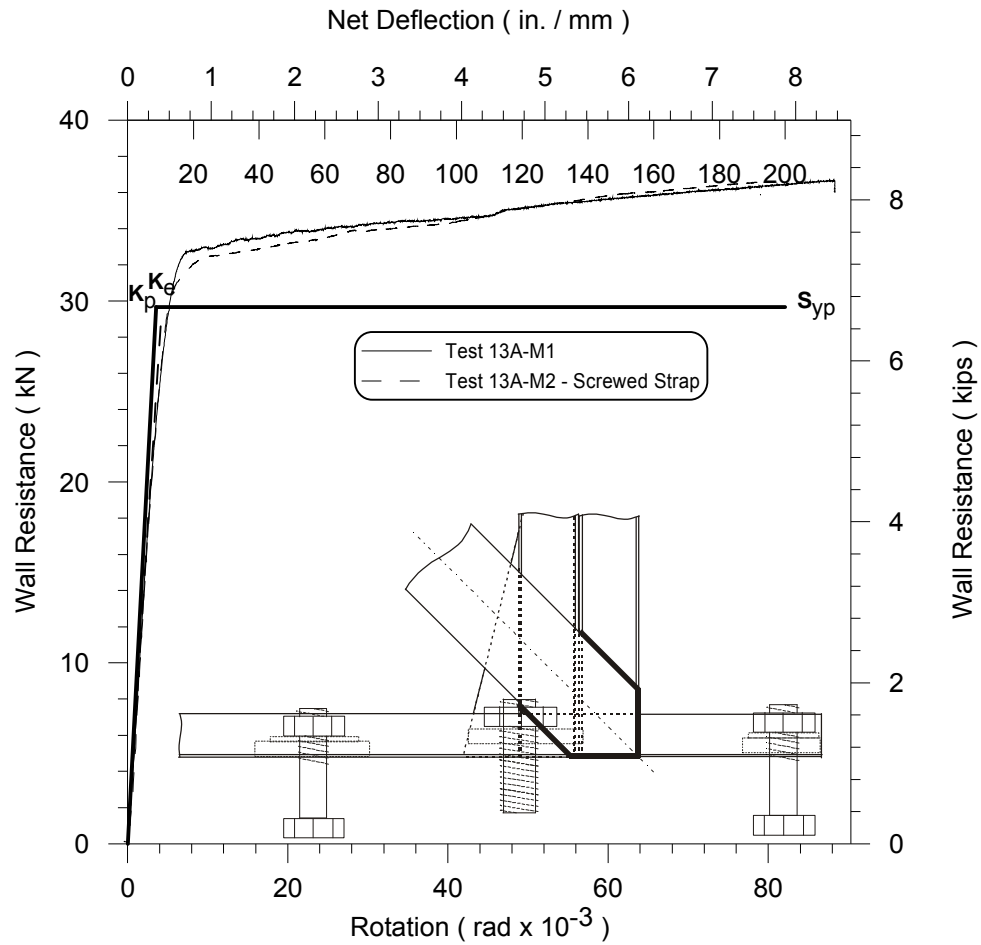

Figure A.1: Monotonic results for test 13A-M

Table A.1: Parameters for monotonic test 13A-M

Test Result	Test	13A-M1	13A-M2	Units
	S _{max}	36.46	36.56	kN
	Δ _{max}	215.10	192.55	mm
	S _v	32.98	32.51	kN
	S _{0.40}	14.58	14.63	kN
	Δ _{S0.40}	5.08	5.40	mm
	K _e	2.87	2.71	kN/mm
	Ductility, μ	18.71	16.03	mm/mm
Prediction (Actual Dimensions)	S _{vp}	29.67	30.18	kN
	K _p	3.44	3.48	kN/mm
Prediction (Nominal Dimensions)	S _{vn}	22.32		kN
	K _n	3.37		kN/mm
Strain Gauge Results		13A-M1		
Gauge	SG1	SG2	SG3	
Max Strain (mm/mm)	4075	16200	16260	
Yielding Strain (mm/mm)	1906	1906	1906	
Yielding Status	OK	OK	OK	

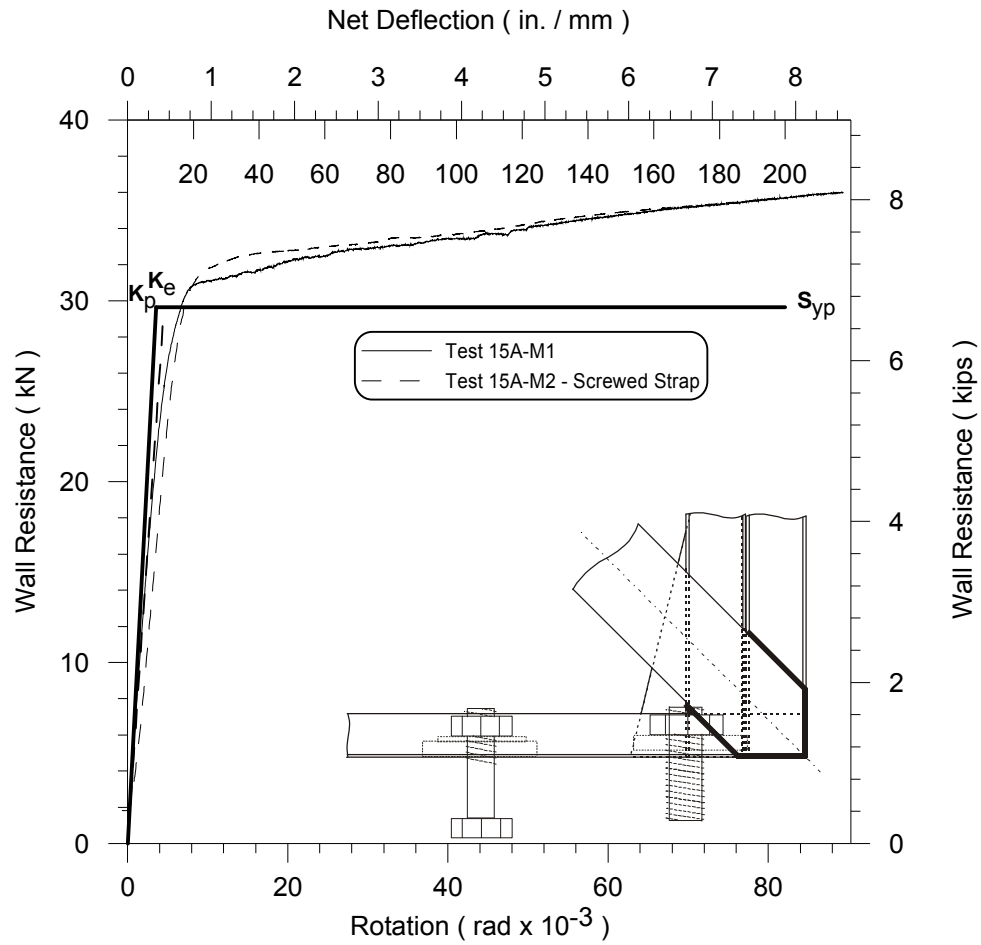

Figure A.2: Monotonic results for test 15A-M

Table A.2: Parameters for monotonic test 15A-M

Test Result	Test	15A-M1	15A-M2	Units
		S _{max}	35.74	35.53
	Δ _{max}	219.67	206.80	mm
	S _y	31.05	32.78	kN
	S _{0.40}	14.30	14.21	kN
	Δ _{S0.40}	5.33	6.53	mm
	K _e	2.68	2.18	kN/mm
	Ductility μ	18.97	13.74	mm/mm
Prediction (Actual Dimensions)	S _{yp}	29.65	29.59	kN
	K _p	3.43	3.43	kN/mm
Prediction (Actual Dimensions)	S _{vn}	22.32		kN
	K _n	3.37		kN/mm
Strain Gauge Results	15A-M1			
Gauge	SG1	SG2	SG3	
Max Strain (mm/mm)	9576	15915	16334	
Yielding Strain (mm/mm)	1906	1906	1906	
Yielding Status	OK	OK	OK	

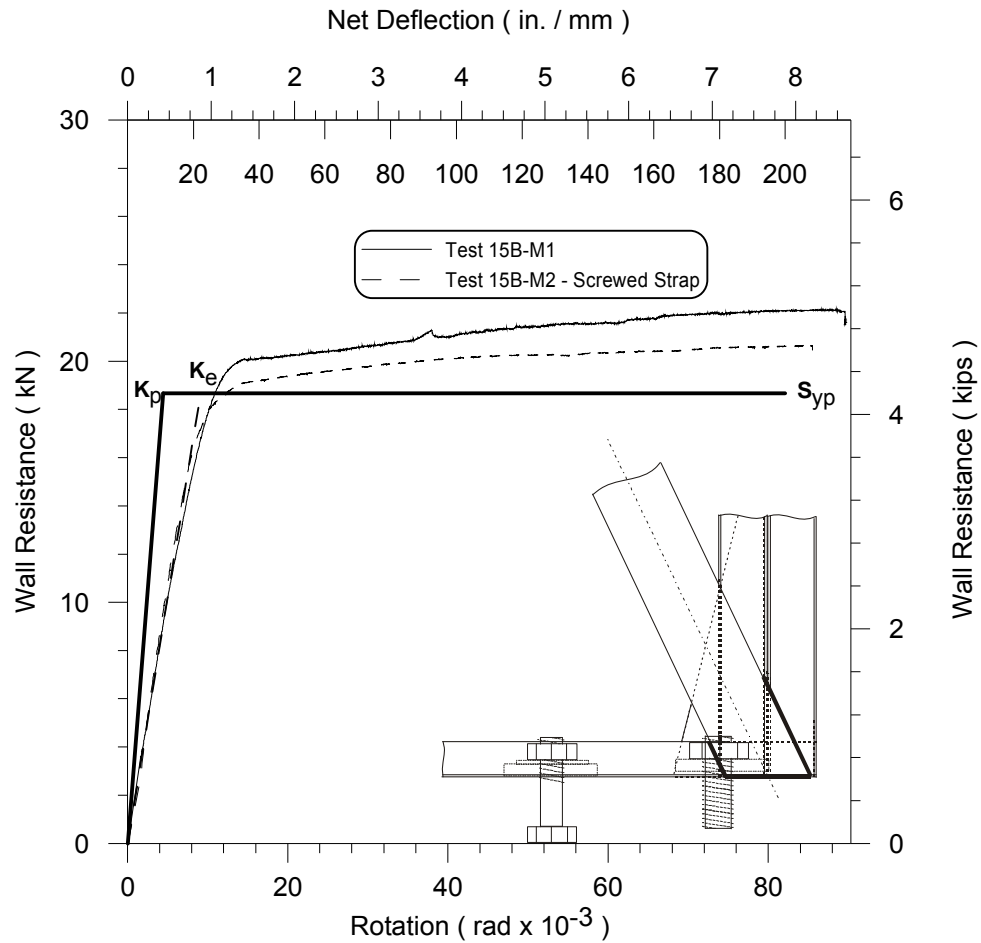

Figure A.3: Monotonic results for test 15B-M

Table A.3: Parameters for monotonic test 15B-M

Test Result	Test	15B-M1	15B-M2	Units
		S _{max}	22.12	20.61
	Δ _{max}	218.33	208.39	mm
	S _y	20.22	19.18	kN
	S _{0.40}	8.85	8.24	kN
	Δ _{S0.40}	10.51	9.31	mm
	K _e	0.84	0.89	kN/mm
	Ductility, μ	9.09	9.62	mm/mm
Prediction (Actual Dimensions)	S _{yp}	18.66	18.75	kN
	K _p	1.73	1.73	kN/mm
Prediction (Nominal Dimensions)	S _{vn}	14.12		kN
	K _n	1.70		kN/mm
Strain Gauge Results		15B-M1		
Gauge	SG1	SG2	SG3	
Max Strain (mm/mm)	16134	16248	16317	
Yielding Strain (mm/mm)	1906	1906	1906	
Yielding Status	OK	OK	OK	

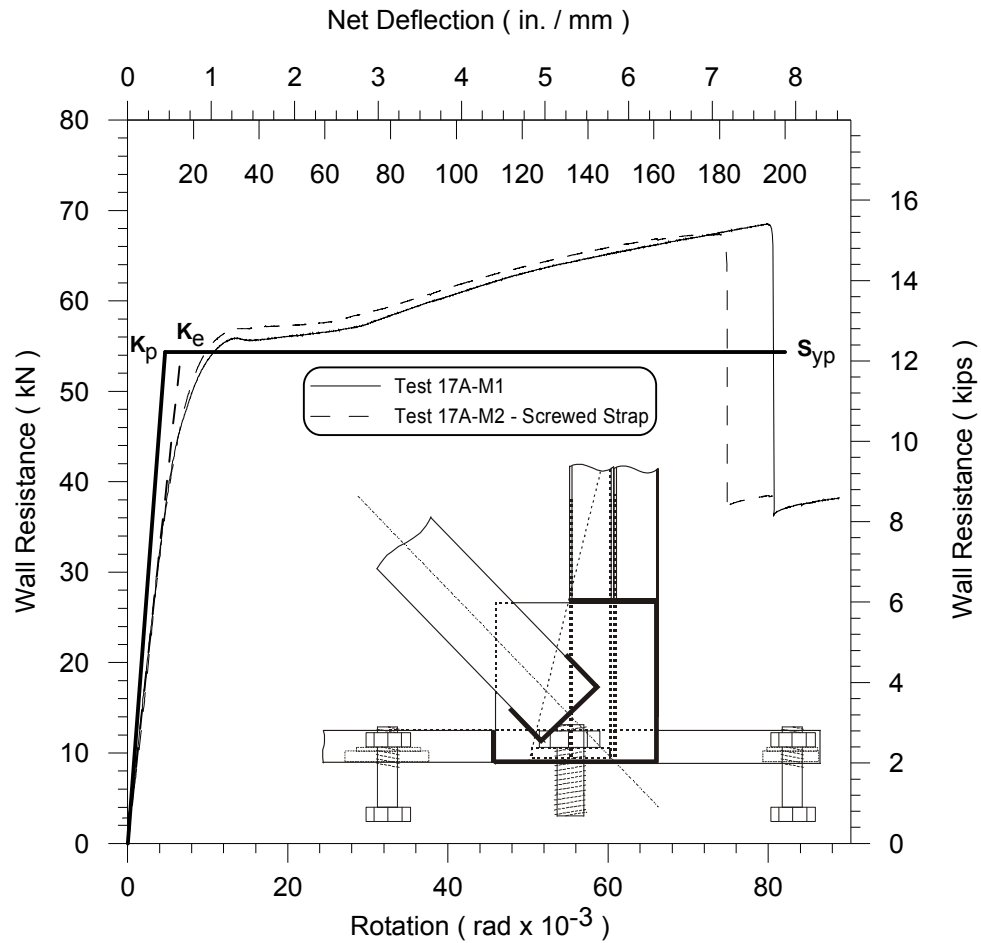

Figure A.4: Monotonic results for test 17A-M

Table A.4: Parameters for monotonic test 17A-M

Test Result	Test	17A-M1	17A-M2	Units
	S _{max}		68.50	67.35
Δ _{max}		196.67	182.18	mm
S _y		55.66	57.28	kN
S _{0.40}		27.40	26.94	kN
Δ _{S0.40}		8.18	8.38	mm
K _e		3.35	3.22	kN/mm
Ductility, μ		11.84	10.23	mm/mm
Prediction (Actual Dimensions)	S _{yp}	54.33	54.31	kN
	K _p	4.80	4.80	kN/mm
Prediction (Nominal Dimensions)	S _{vn}	46.76		kN
	K _n	4.66		kN/mm
Strain Gauge Results	17A-M1			
Gauge	SG1	SG2	SG3	
Max Strain (mm/mm)	2243	6342	16332	
Yielding Strain (mm/mm)	1457	1457	1457	
Yielding Status	OK	OK	OK	

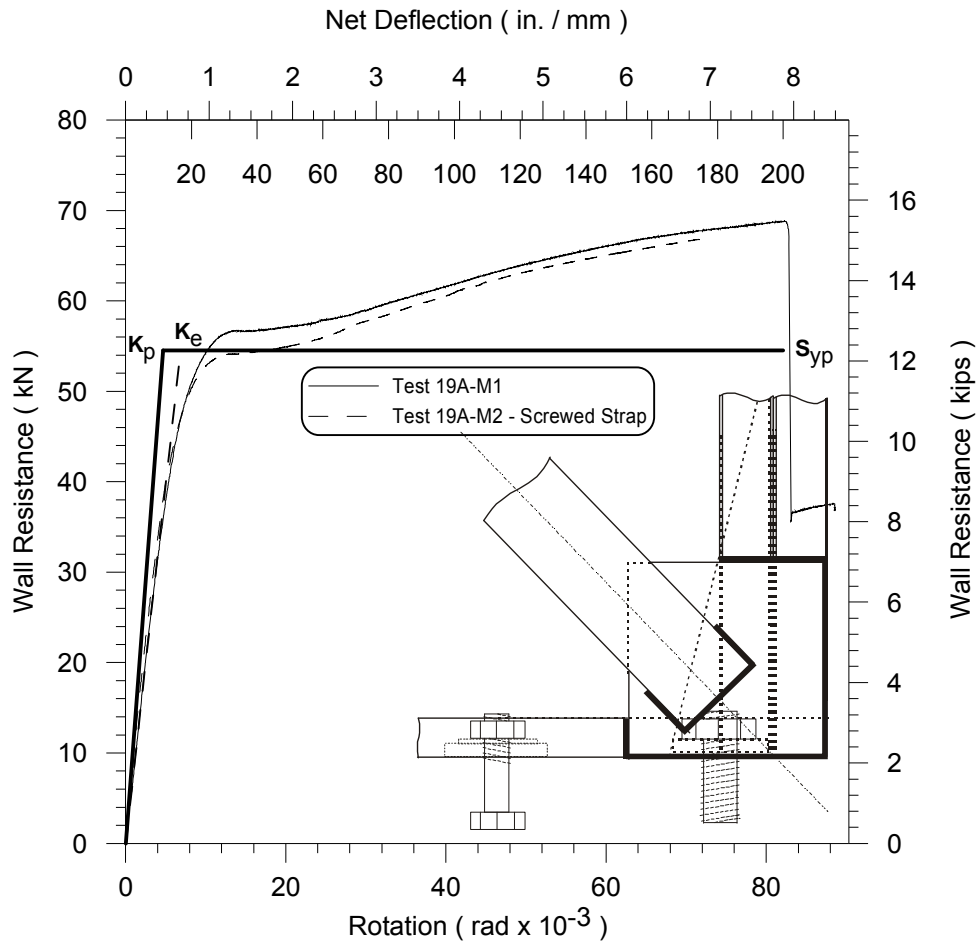

Figure A.5: Monotonic results for test 19A-M

Table A.5: Parameters for monotonic test 19A-M

Test Result	Test	19A-M1	19A-M2	Units
	S_{max}		68.78	66.86
Δ_{max}		215.68	175.83	mm
S_y		56.66	54.16	kN
$S_{0.40}$		27.51	26.74	kN
$\Delta_{S0.40}$		8.41	7.85	mm
K_e		3.27	3.41	kN/mm
Ductility, μ		11.69	11.06	mm/mm
Prediction (Actual Dimensions)	S_{yp}	54.53	54.43	kN
	K_p	4.81	4.81	kN/mm
Prediction (Nominal Dimensions)	S_{vn}	46.76		kN
	K_n	4.66		kN/mm
Strain Gauge Results	19A-M1			
Gauge	SG1	SG2	SG3	
Max Strain (mm/mm)	16055	16697	16799	
Yielding Strain (mm/mm)	1457	1457	1457	
Yielding Status	OK	OK	OK	

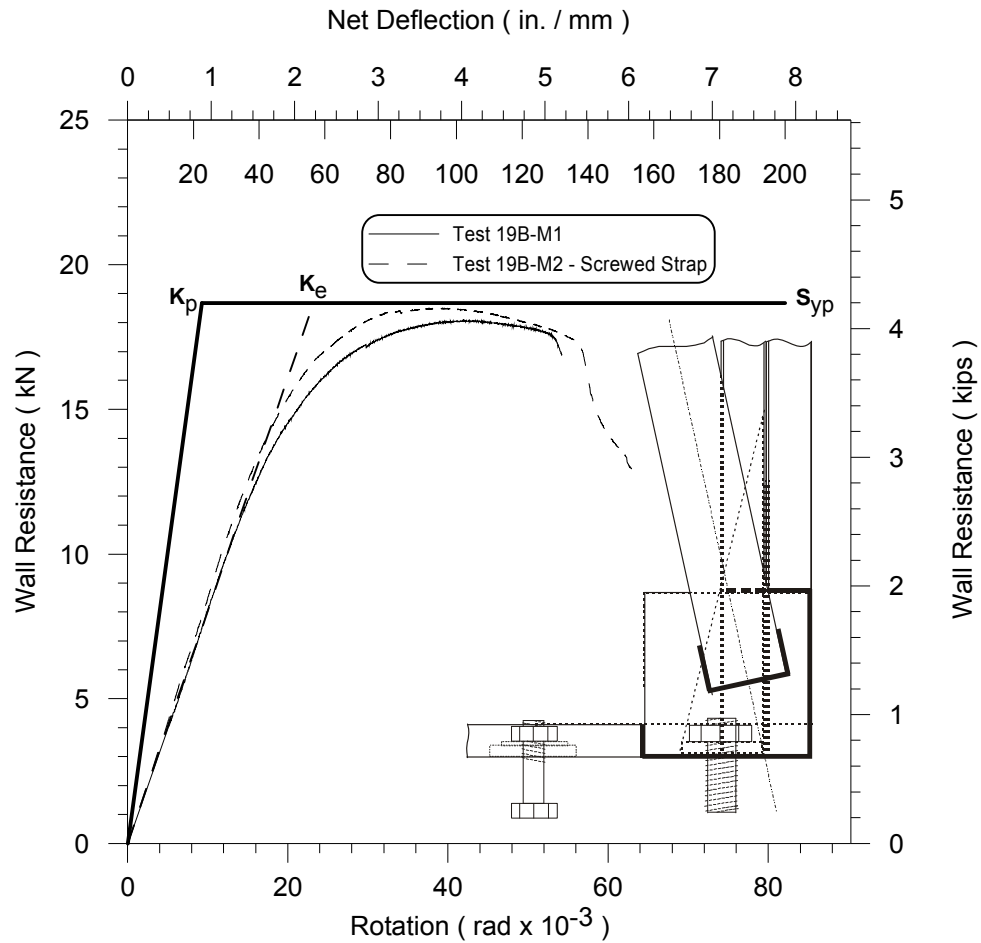

Figure A.6: Monotonic results for test 19B-M

Table A.6: Parameters for monotonic test 19B-M

Test Result	Test	19B-M1	19B-M2	Units
	S_{max}		18.11	18.49
Δ_{max}		132.15	156.98	mm
S_y		18.11	18.49	kN
$S_{0.40}$		7.24	7.40	kN
$\Delta_{S0.40}$		21.90	23.61	mm
K_e		0.33	0.31	kN/mm
Ductility, μ		2.41	2.66	mm/mm
Prediction (Actual Dimensions)	S_{yp}	18.68	18.68	kN
	K_p	0.83	0.83	kN/mm
Prediction (Nominal Dimensions)	S_{vn}	16.04		kN
	K_n	0.80		kN/mm
Strain Gauge Results		19B-M1		
Gauge	SG1	SG2	SG3	
Max Strain (mm/mm)	6493	8625	10575	
Yielding Strain (mm/mm)	1457	1457	1457	
Yielding Status	OK	OK	OK	

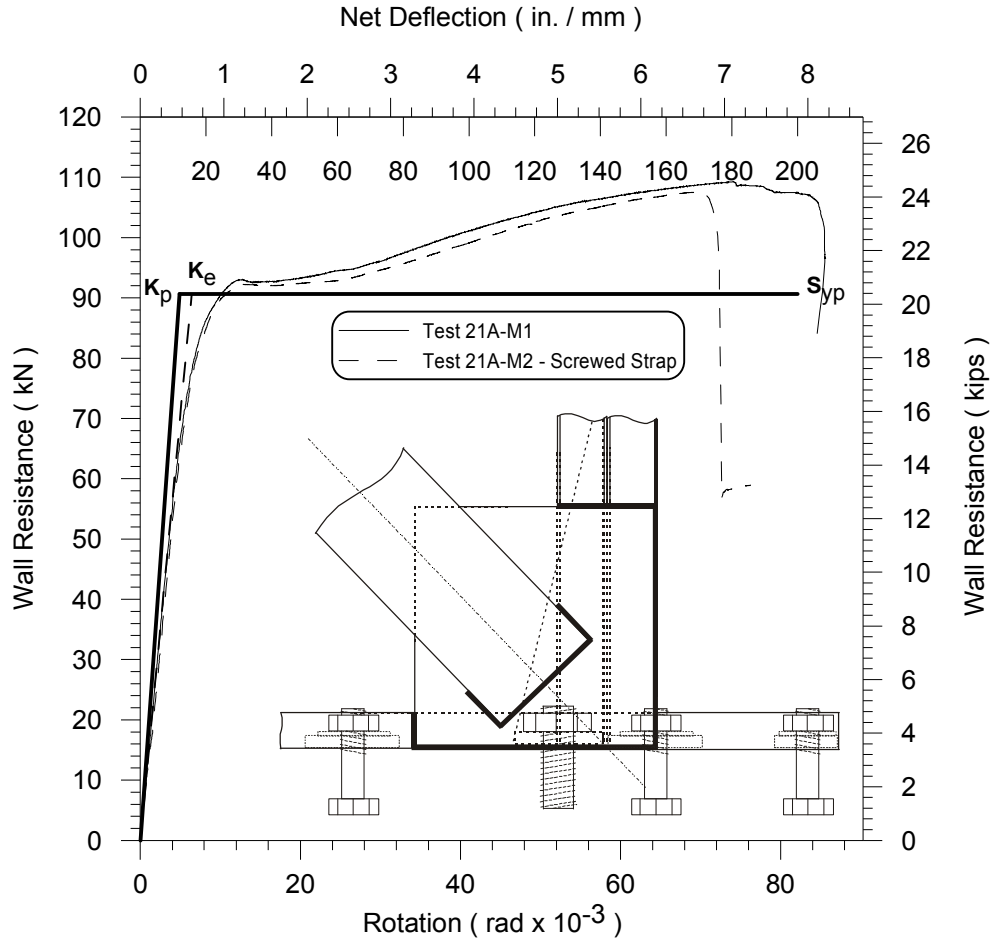

Figure A.7: Monotonic results for test 21A-M

Table A.7: Parameters for monotonic test 21A-M

Test Result	Test	21A-M1	21A-M2	Units
		S _{max}	109.27	107.53
	Δ _{max}	208.25	198.14	mm
	S _y	92.68	92.04	kN
	S _{0.40}	43.71	43.01	kN
	Δ _{S0.40}	7.50	8.01	mm
	K _e	5.83	5.37	kN/mm
	Ductility, μ	12.95	10.33	mm/mm
Prediction (Actual Dimensions)	S _{yp}	90.66	91.24	kN
	K _p	7.65	7.69	kN/mm
Prediction (Nominal Dimensions)	S _{vn}	85.61		kN
	K _n	7.47		kN/mm
Strain Gauge Results		21A-M1		
Gauge	SG4	SG5	SG3	
Max Strain (mm/mm)	16035	16335	16202	
Yielding Strain (mm/mm)	1737	1737	1737	
Yielding Status	OK	OK	OK	

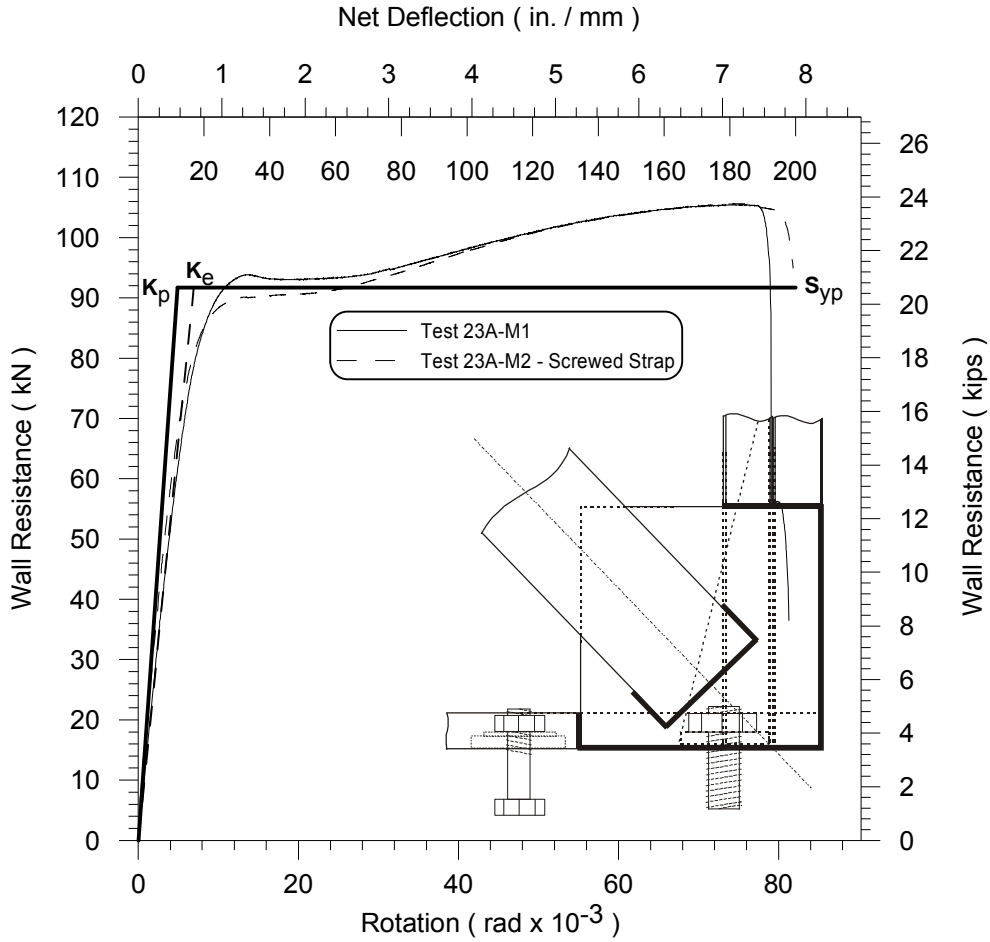

Figure A.8: Monotonic results for test 23A-M

Table A.8: Parameters for monotonic test 23A-M

Test Result	Test	23A-M1	23A-M2	Units
		S _{max}	105.46	105.65
	Δ _{max}	199.13	200.33	mm
	S _y	93.07	90.51	kN
	S _{0.40}	42.18	42.26	kN
	Δ _{S0.40}	7.74	7.69	mm
	K _e	5.45	5.50	kN/mm
	Ductility, μ	11.33	12.17	mm/mm
Prediction (Actual Dimensions)	S _{yp}	91.68	91.24	kN
	K _p	7.71	7.69	kN/mm
Prediction (Nominal Dimensions)	S _{vn}	85.61		kN
	K _n	7.47		kN/mm
Strain Gauge Results		23A-M1		
Gauge	SG1	SG2	SG3	
Max Strain (mm/mm)	14130	16307	16381	
Yielding Strain (mm/mm)	1737	1737	1737	
Yielding Status	OK	OK	OK	

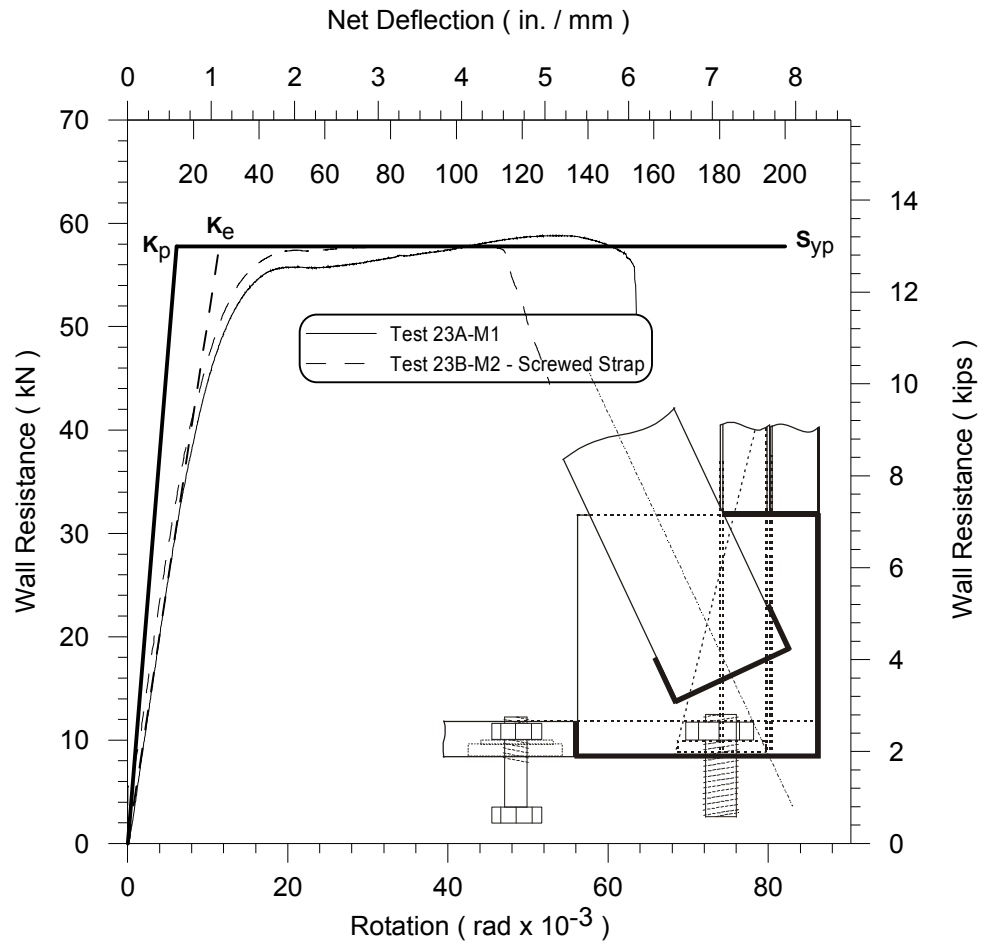

Figure A.9: Monotonic results for test 23B-M

Table A.9: Parameters for monotonic test 23B-M

Test Result	Test	23B-M1	23B-M2	Units
	S_{max}		58.85	57.85
Δ_{max}		156.00	132.72	mm
S_y		55.71	57.36	kN
$S_{0.40}$		23.54	23.14	kN
$\Delta_{S0.40}$		11.34	13.97	mm
K_e		2.08	1.66	kN/mm
Ductility, μ		5.81	3.78	mm/mm
Prediction (Actual Dimensions)	S_{yp}	57.76	57.70	kN
	K_p	3.88	3.88	kN/mm
Prediction (Nominal Dimensions)	S_{vn}	54.15		kN
	K_n	3.77		kN/mm
Strain Gauge Results	23B-M1			
Gauge	SG1	SG2	SG3	
Max Strain (mm/mm)	16132	16206	16335	
Yielding Strain (mm/mm)	1737	1737	1737	
Yielding Status	OK	OK	OK	

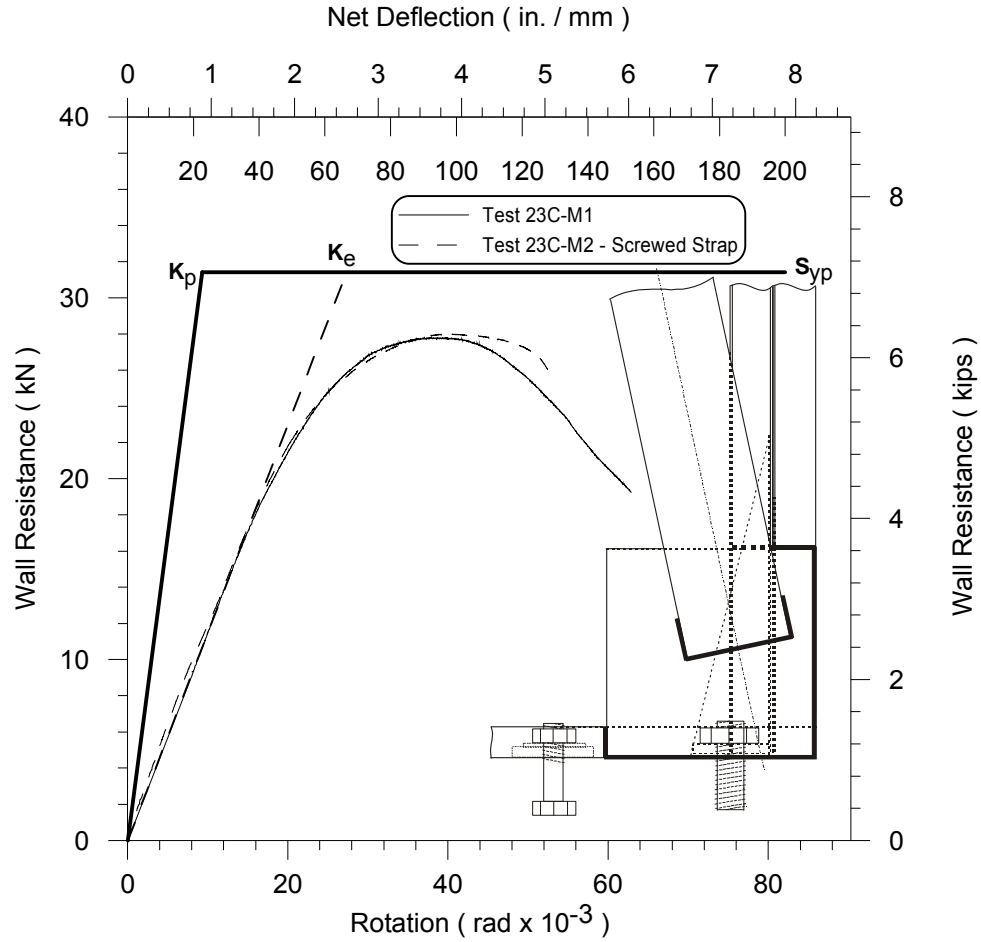

Figure A.10: Monotonic results for test 23C-M

Table A.10: Parameters for monotonic test 23C-M

Test Result	Test	23C-M1	23C-M2	Units
	S_{max}		27.83	28.00
Δ_{max}		153.14	127.73	mm
S_y		27.83	28.00	kN
$S_{0.40}$		11.13	11.20	kN
$\Delta_{S0.40}$		23.59	22.62	mm
K_e		0.47	0.50	kN/mm
Ductility, μ		2.34	2.26	mm/mm
Prediction (Actual Dimensions)	S_{yp}	31.42	31.28	kN
	K_p	1.39	1.38	kN/mm
Prediction (Nominal Dimensions)	S_{vn}	29.37		kN
	K_n	1.34		kN/mm
Strain Gauge Results	23C-M1			
Gauge	SG1	SG2	SG3	
Max Strain (mm/mm)	3993	3470	9796	
Yielding Strain (mm/mm)	1737	1737	1737	
Yielding Status	OK	OK	OK	

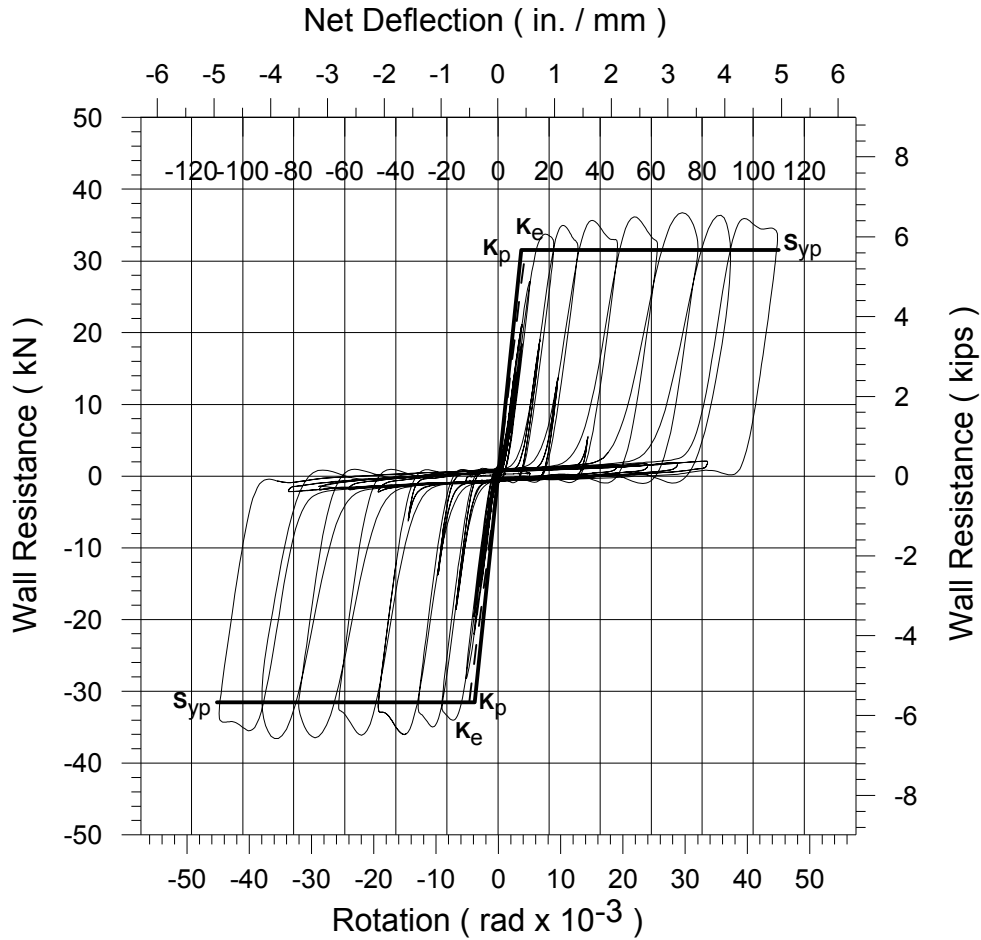

Figure A.11: Cyclic results for test 14A-C

Table A.11: Parameters for cyclic test 14A-C

Test Result	Parameters	Negative	Positive	Units		
	S_{max}	-36.59	36.72	kN		
	Δ_{max}	-109.27	109.46	mm		
	$S_{0.40}$	-14.63	14.69	kN		
	$\Delta_{0.40}$	-5.23	5.02	mm		
	K_e	2.80	2.93	kN/mm		
	Ductility, μ	8.35	8.73	mm/mm		
Prediction (Actual Dimensions)	S_{yp}	-31.52	31.52	kN		
	K_p	3.44	3.44	kN/mm		
Prediction (Nominal Dimensions)	S_{yn}	-22.32	22.32	kN		
	K_n	3.37	3.37	kN/mm		
Strain Gauge Results						
Gauge	SG1	SG2	SG3	SG4	SG5	SG6
Max Strain (mm/mm)	15753	16240	16194	16512	6327	16724
Yielding Strain (mm/mm)	1906	1906	1906	1906	1906	1906
Yielding Status	OK	OK	OK	OK	OK	OK

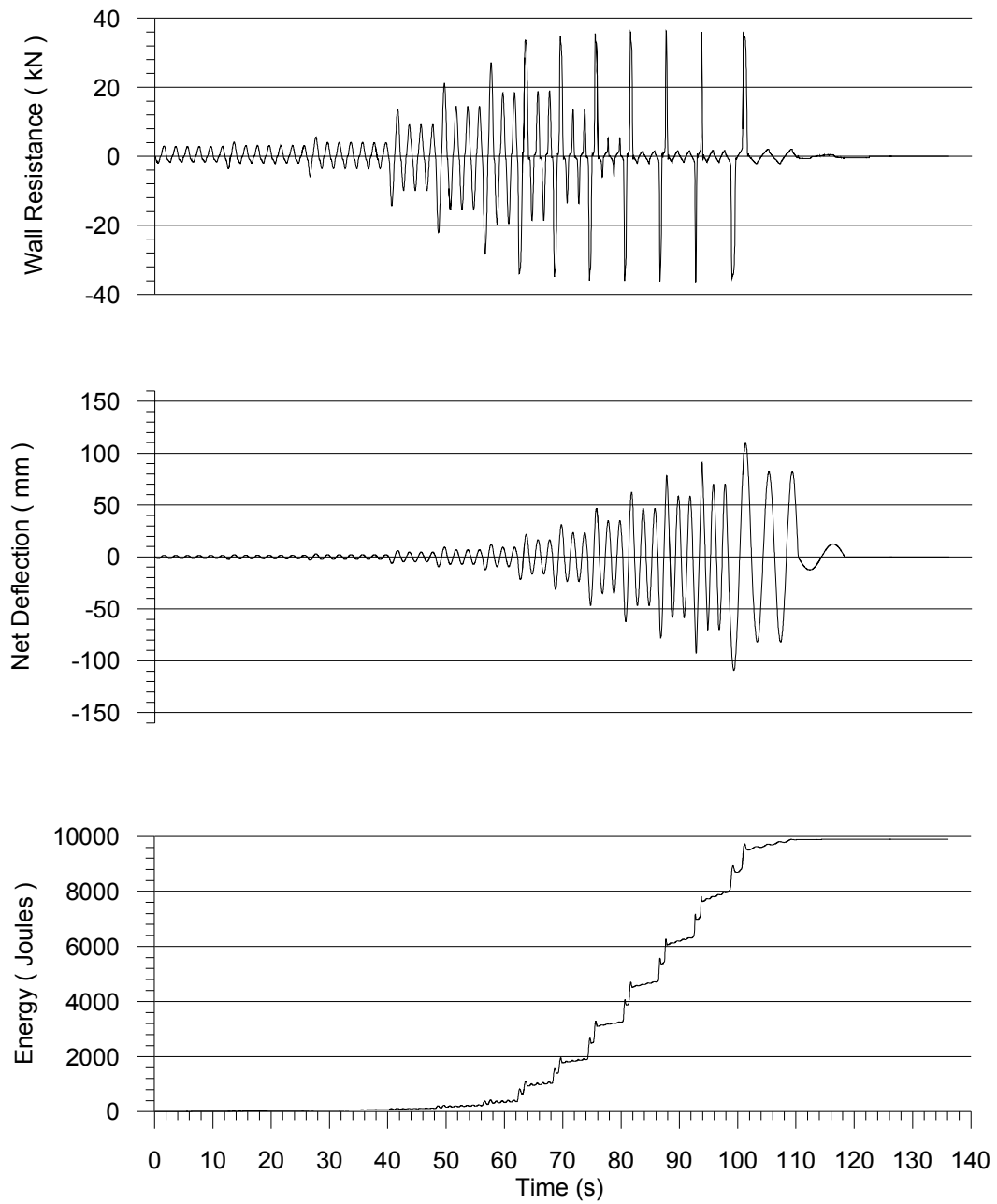

Figure A.12: Time history results for test 14A-C

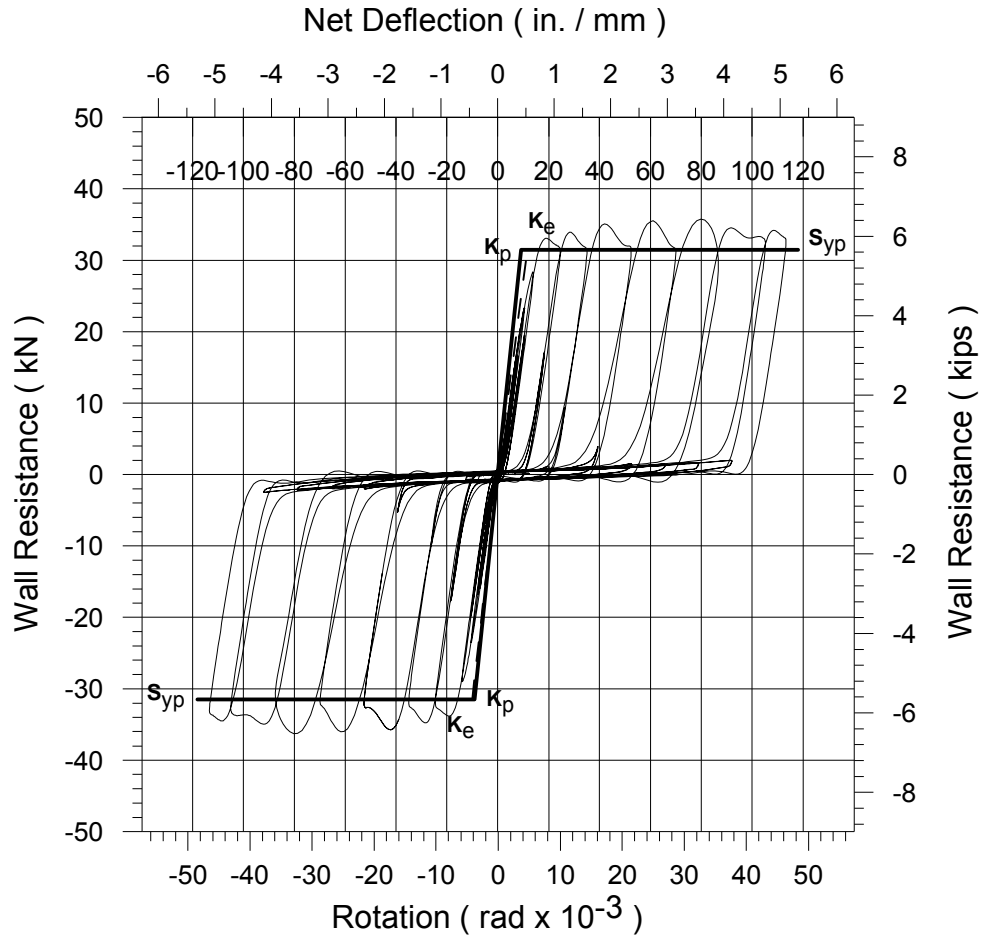

Figure A.13: Cyclic results for test 16A-C

Table A.12: Parameters for cyclic test 16A-C

Test Result	Parameters	Negative	Positive	Units		
	S_{max}	-36.29	35.79	kN		
Δ_{max}	-113.28	113.29	mm			
$S_{0.40}$	-14.52	14.31	kN			
$\Delta_{0.40}$	-4.66	5.28	mm			
K_e	3.11	2.71	kN/mm			
Ductility, μ	9.72	8.58	mm/mm			
Prediction (Actual Dimensions)	S_{yp}	-31.47	31.47	kN		
	K_p	3.44	3.44	kN/mm		
Prediction (Nominal Dimensions)	S_{yn}	-22.32	22.32	kN		
	K_n	3.37	3.37	kN/mm		
Strain Gauge Results						
Gauge	SG1	SG2	SG3	SG4	SG5	SG6
Max Strain (mm/mm)	15936	15900	16435	16503	16139	16716
Yielding Strain (mm/mm)	1906	1906	1906	1906	1906	1906
Yielding Status	OK	OK	OK	OK	OK	OK

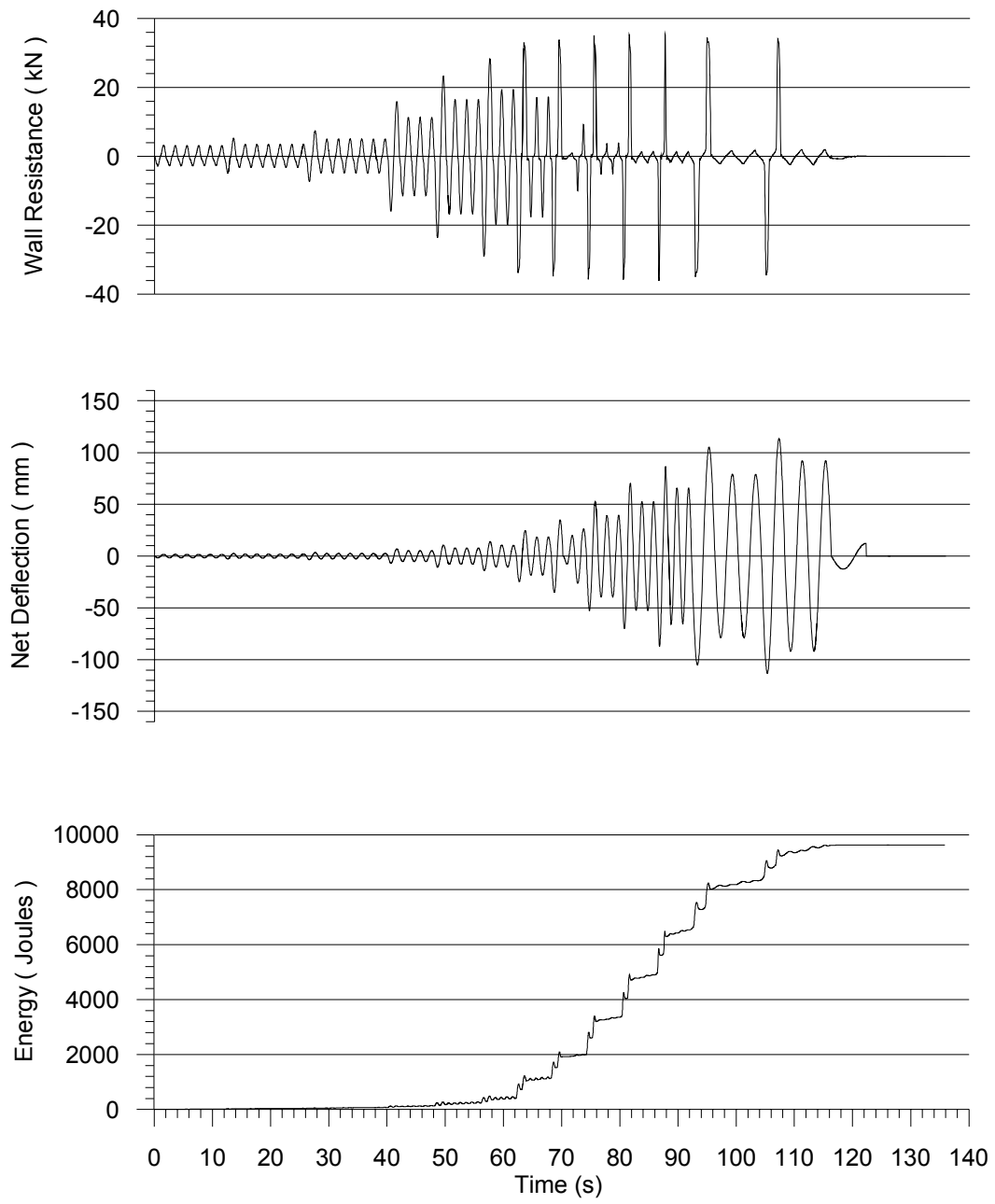

Figure A.14: Time history results for test 16A-C

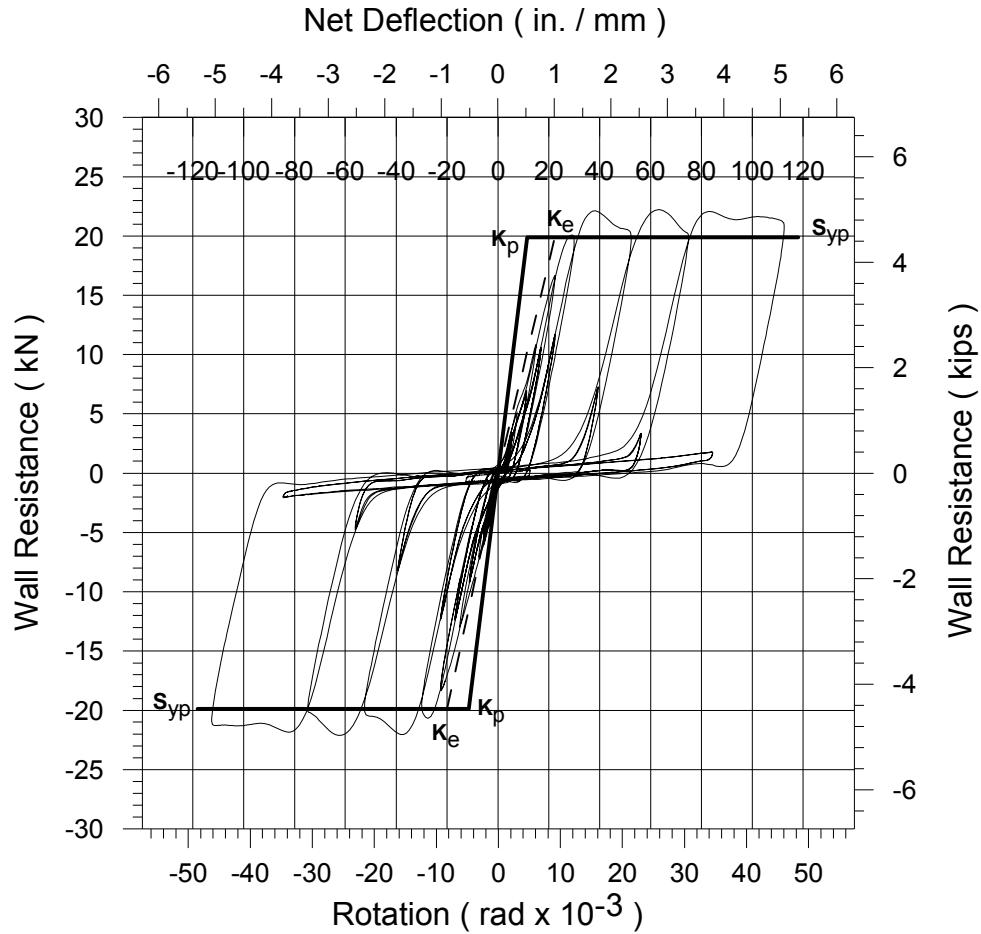

Figure A.15: Cyclic results for test 16B-C

Table A.13: Parameters for cyclic test 16B-C

Test Result	Parameters	Negative	Positive	Units		
	S_{max}	-22.11	22.22	kN		
	Δ_{max}	-112.49	112.57	mm		
	$S_{0.40}$	-8.84	8.89	kN		
	$\Delta_{0.40}$	-8.89	10.00	mm		
	K_e	0.99	0.89	kN/mm		
	Ductility, μ	5.06	4.50	mm/mm		
Prediction (Actual Dimensions)	S_{yp}	-19.88	19.88	kN		
	K_p	1.73	1.73	kN/mm		
Prediction (Nominal Dimensions)	S_{yn}	-14.12	14.12	kN		
	K_n	1.70	1.70	kN/mm		
Strain Gauge Results						
Gauge	SG1	SG2	SG3	SG4	SG5	SG6
Max Strain (mm/mm)	16119	11164	16779	16194	16311	16162
Yielding Strain (mm/mm)	1906	1906	1906	1906	1906	1906
Yielding Status	OK	OK	OK	OK	OK	OK

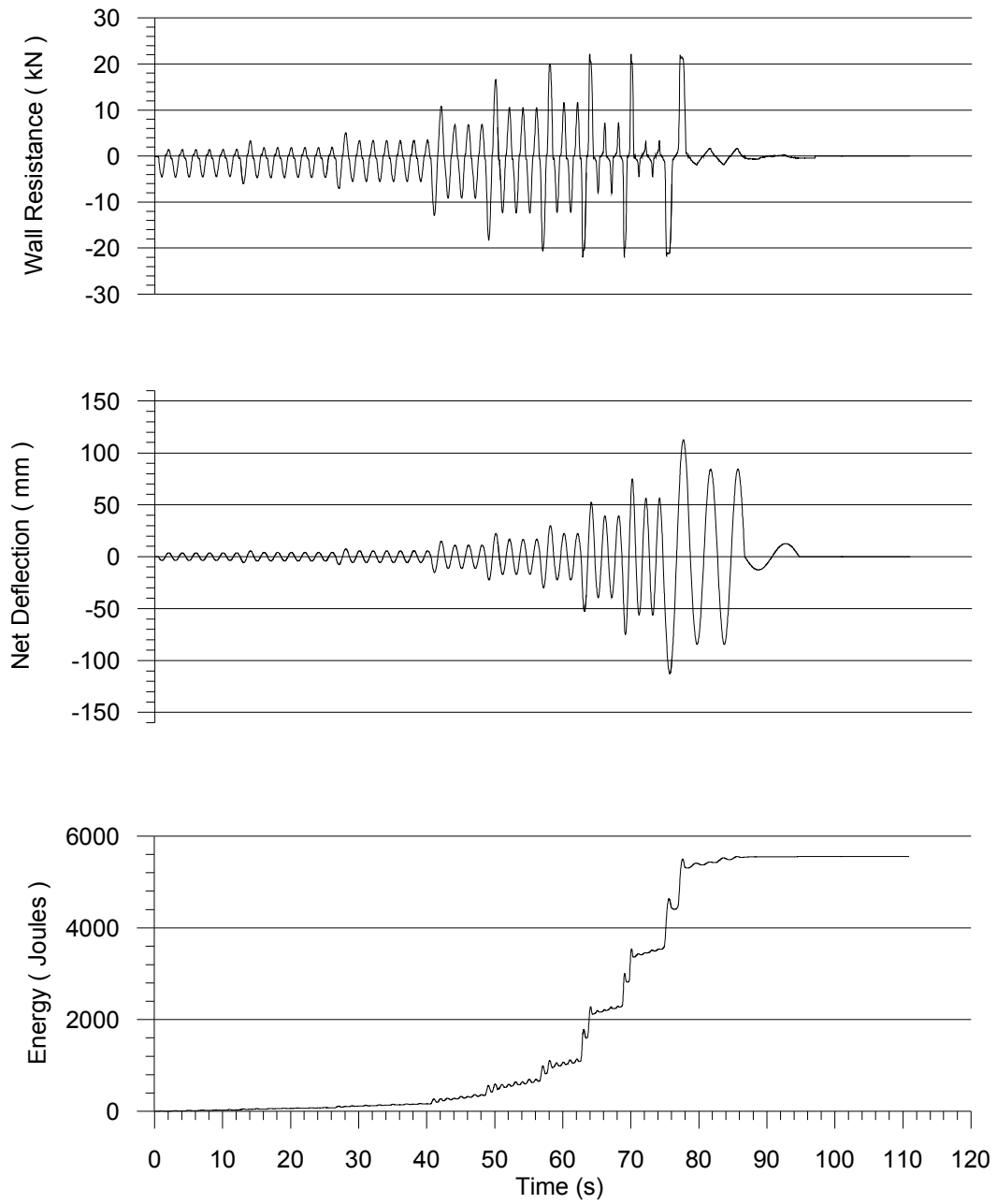

Figure A.16: Time history results for test 16B-C

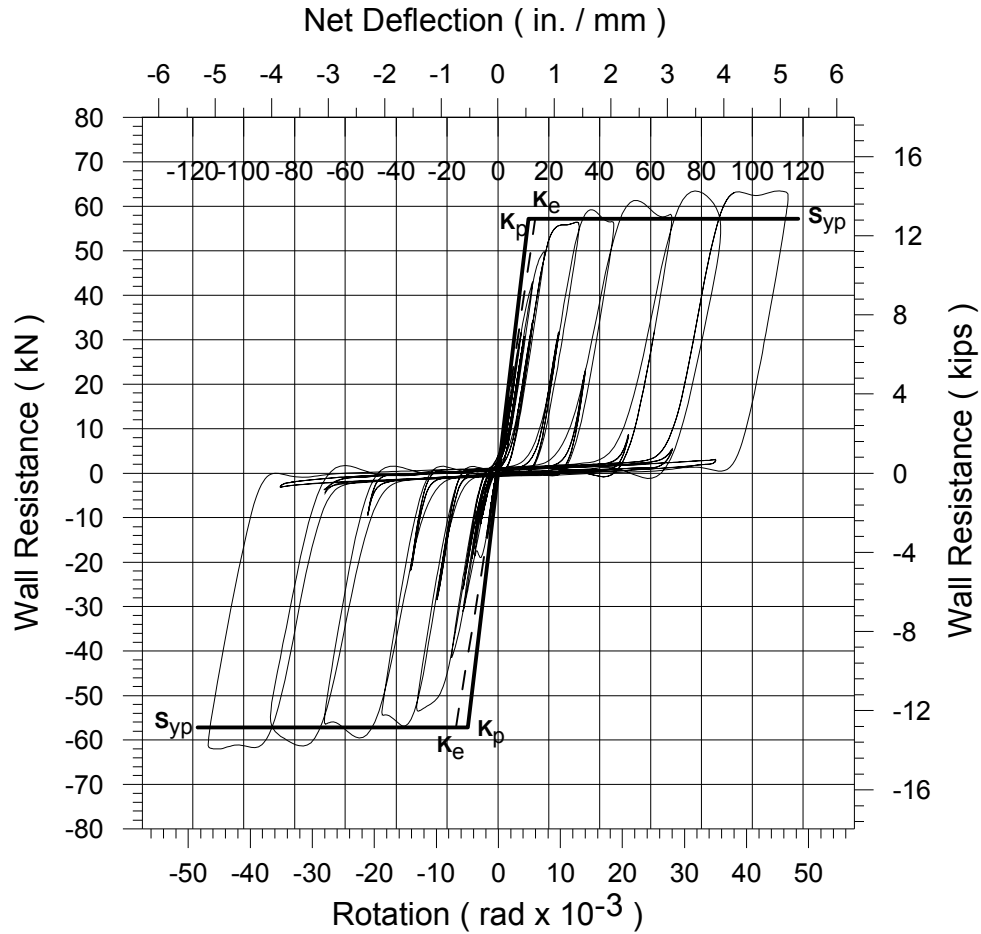

Figure A.17: Cyclic results for test 18A-C

Table A.14: Parameters for cyclic test 18A-C

Test Result	Parameters	Negative	Positive	Units		
	S_{max}		-62.04	63.48	kN	
Δ_{max}		-113.98	114.12	mm		
$S_{0.40}$		-24.82	25.39	kN		
$\Delta_{0.40}$		-7.17	6.50	mm		
K_e		3.46	3.91	kN/mm		
Ductility, μ		6.36	7.02	mm/mm		
Prediction (Actual Dimensions)	S_{yp}	-57.18	57.18	kN		
	K_p	4.79	4.79	kN/mm		
Prediction (Nominal Dimensions)	S_{yn}	-46.76	46.76	kN		
	K_n	4.66	4.66	kN/mm		
Strain Gauge Results						
Gauge	SG1	SG2	SG3	SG4	SG5	SG6
Max Strain (mm/mm)	16139	16236	16306	16472	16125	16728
Yielding Strain (mm/mm)	1906	1906	1906	1906	1906	1906
Yielding Status	OK	OK	OK	OK	OK	OK

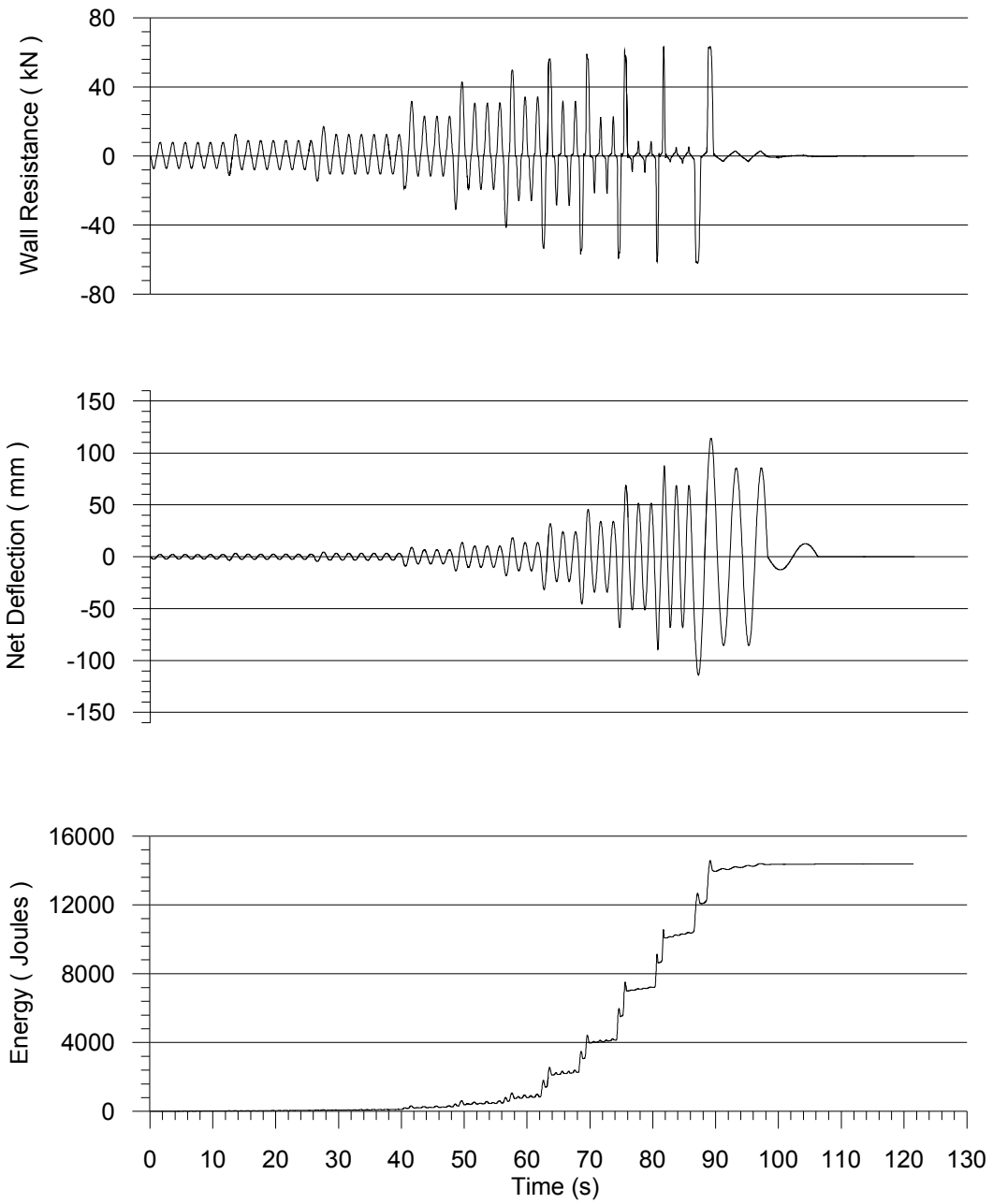

Figure A.18: Time history results for test 18A-C

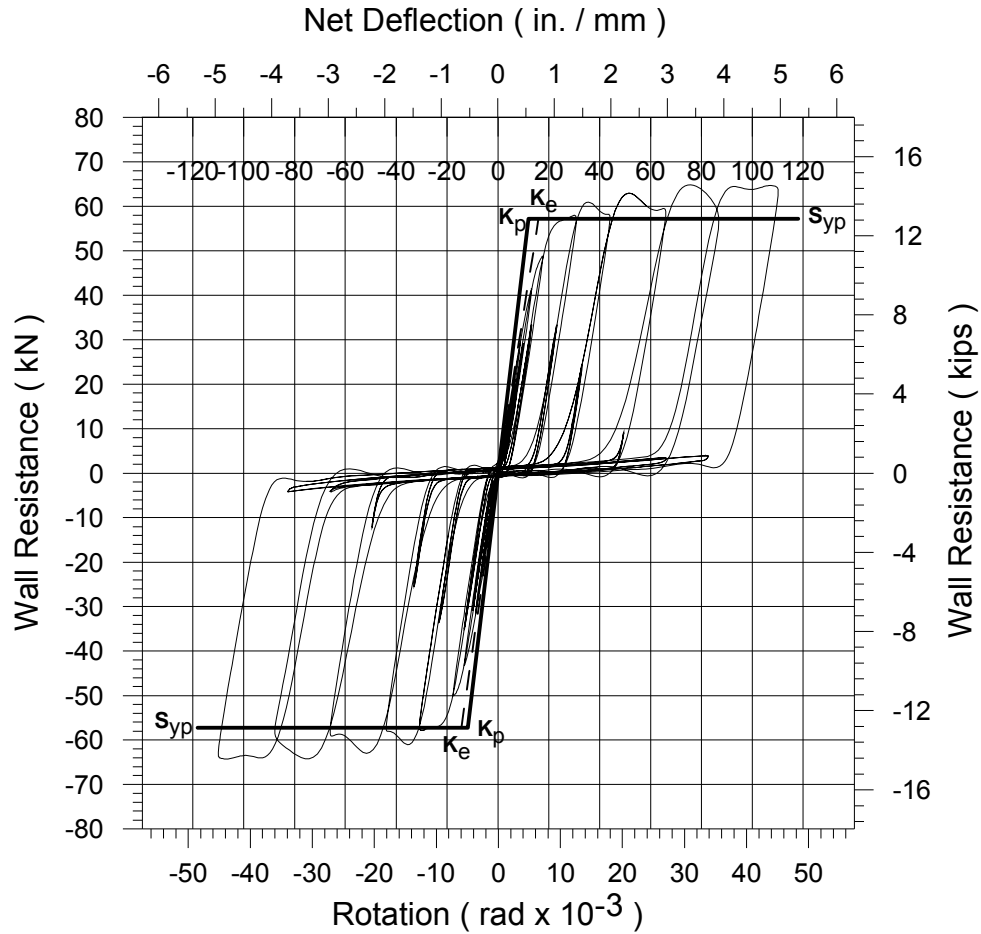

Figure A.19: Cyclic results for test 20A-C

Table A.15: Parameters for cyclic test 20A-C

Test Result	Parameters	Negative	Positive	Units		
	S_{max}	-64.27	64.86	kN		
	Δ_{max}	-109.98	110.19	mm		
	$S_{0.40}$	-25.71	25.94	kN		
	$\Delta_{0.40}$	-6.49	7.23	mm		
	K_e	3.96	3.59	kN/mm		
	Ductility, μ	6.78	6.10	mm/mm		
Prediction (Actual Dimensions)	S_{yp}	-57.25	57.25	kN		
	K_p	4.81	4.81	kN/mm		
Prediction (Nominal Dimensions)	S_{yn}	-46.76	46.76	kN		
	K_n	4.66	4.66	kN/mm		
Strain Gauge Results						
Gauge	SG1	SG2	SG3	SG4	SG5	SG6
Max Strain (mm/mm)	16123	16595	16643	16254	16349	16701
Yielding Strain (mm/mm)	1906	1906	1906	1906	1906	1906
Yielding Status	OK	OK	OK	OK	OK	OK

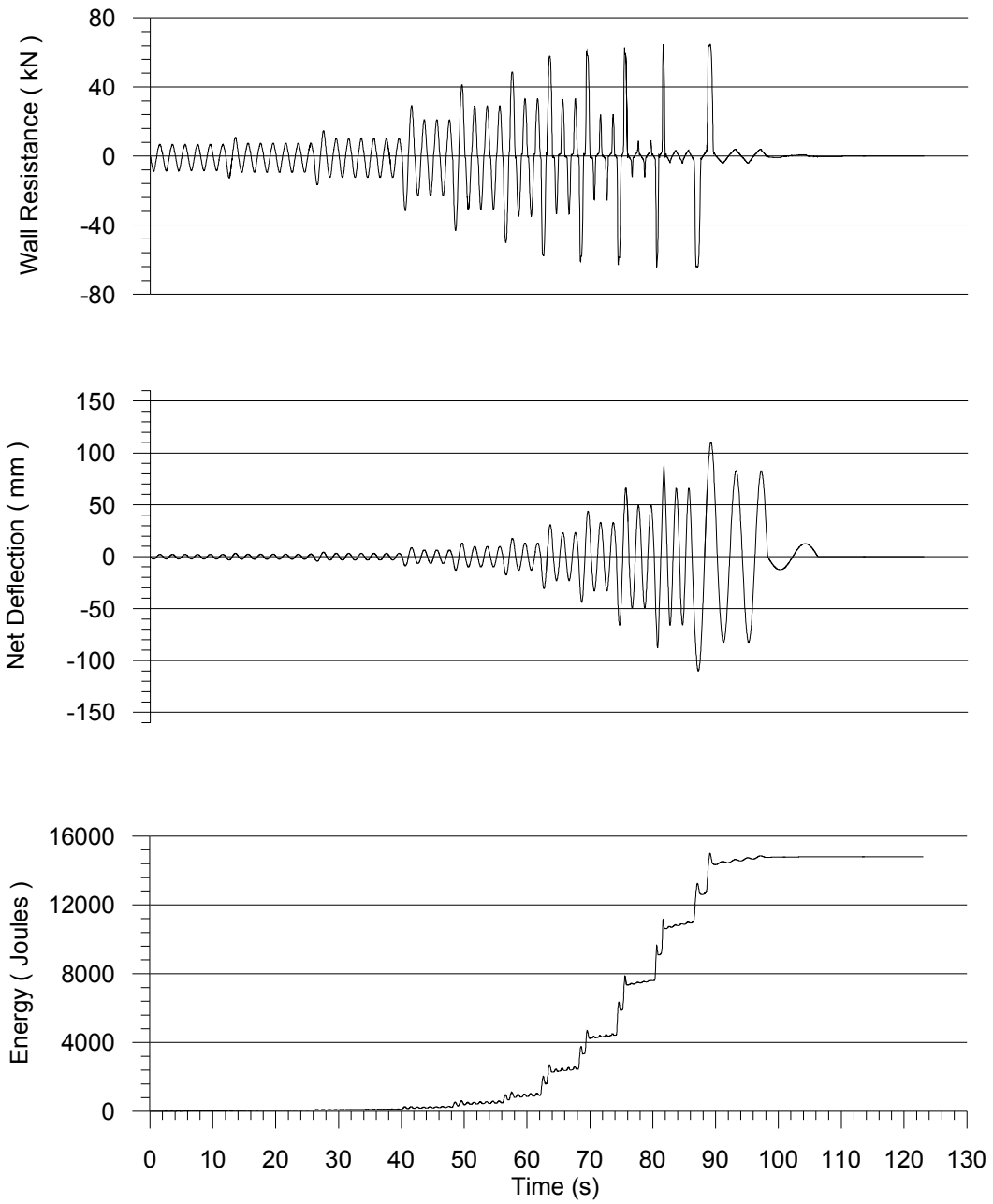

Figure A.20: Time history results for test 20A-C

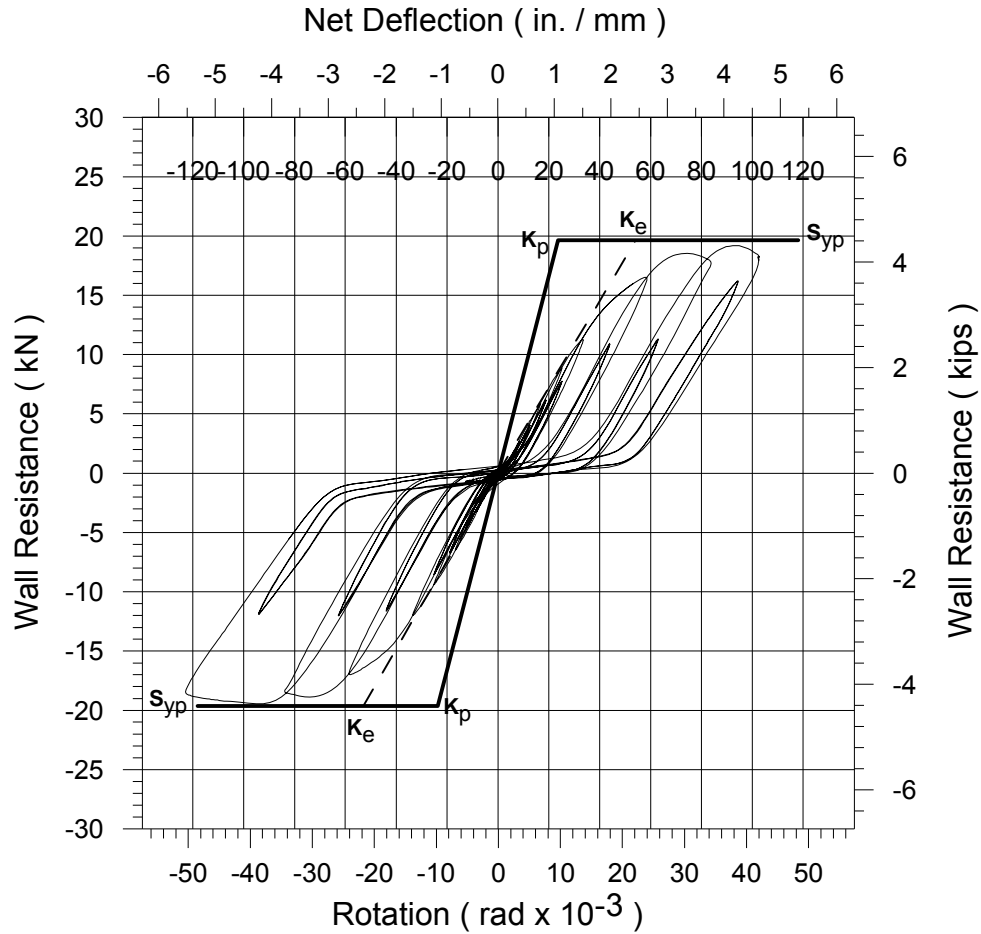

Figure A.21: Cyclic results for test 20B-C

Table A.16: Parameters for cyclic test 20B-C

Test Result	Parameters	Negative	Positive	Units		
	S _{max}	-19.46	19.20	kN		
	Δ _{max}	-122.87	102.75	mm		
	S _{0.40}	-7.78	7.68	kN		
	Δ _{0.40}	-21.00	21.17	mm		
	K _e	0.37	0.36	kN/mm		
	Ductility, μ	2.34	1.94	mm/mm		
Prediction (Actual Dimensions)	S _{yp}	-19.63	19.63	kN		
	K _p	0.83	0.83	kN/mm		
Prediction (Nominal Dimensions)	S _{yn}	-16.04	16.04	kN		
	K _n	0.80	0.80	kN/mm		
Strain Gauge Results						
Gauge	SG1	SG2	SG3	SG4	SG5	SG6
Max Strain (mm/mm)	9913	5178	11798	15301	5331	11800
Yielding Strain (mm/mm)	1906	1906	1906	1906	1906	1906
Yielding Status	OK	OK	OK	OK	OK	OK

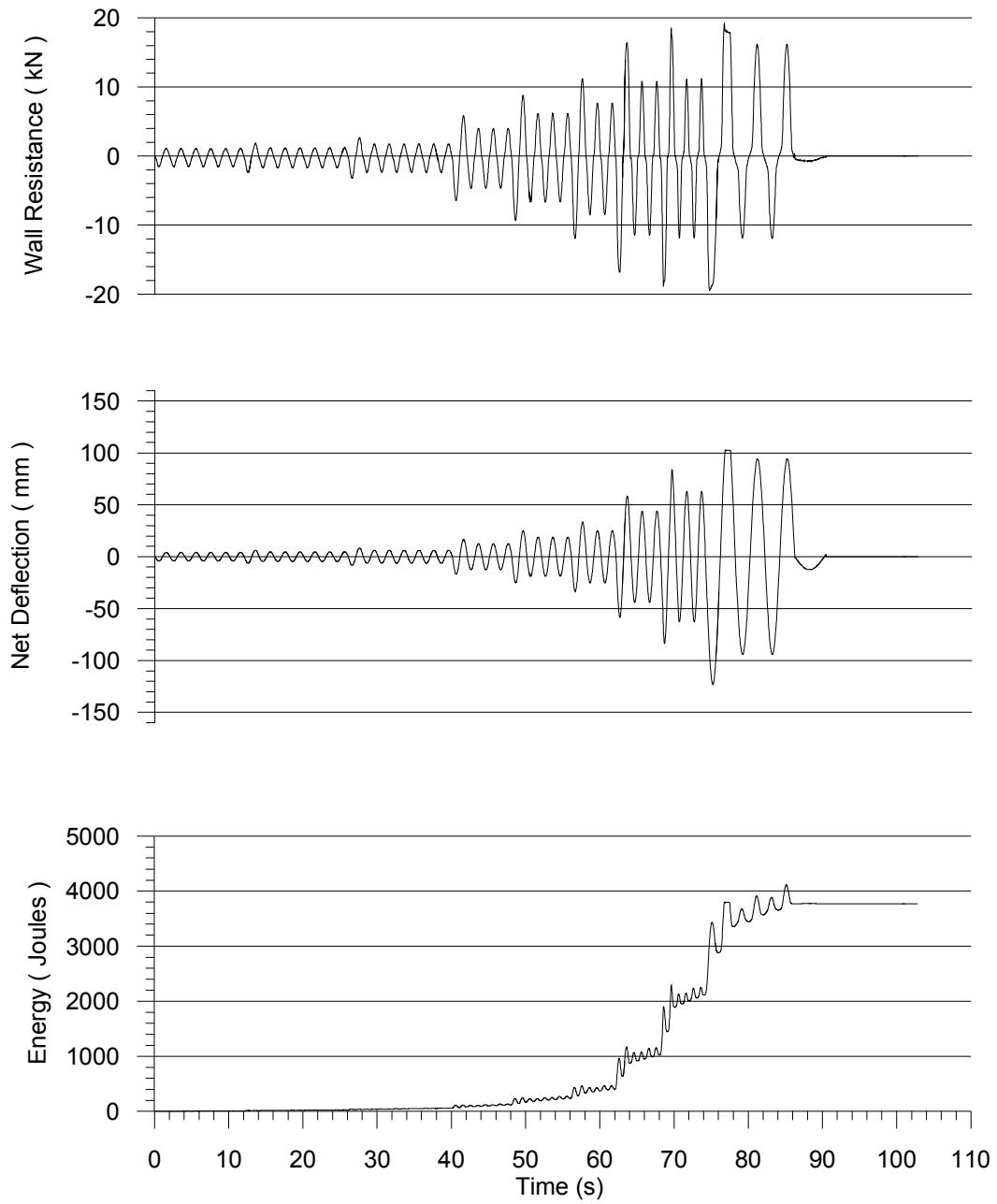

Figure A.22: Time history results for test 20B-C

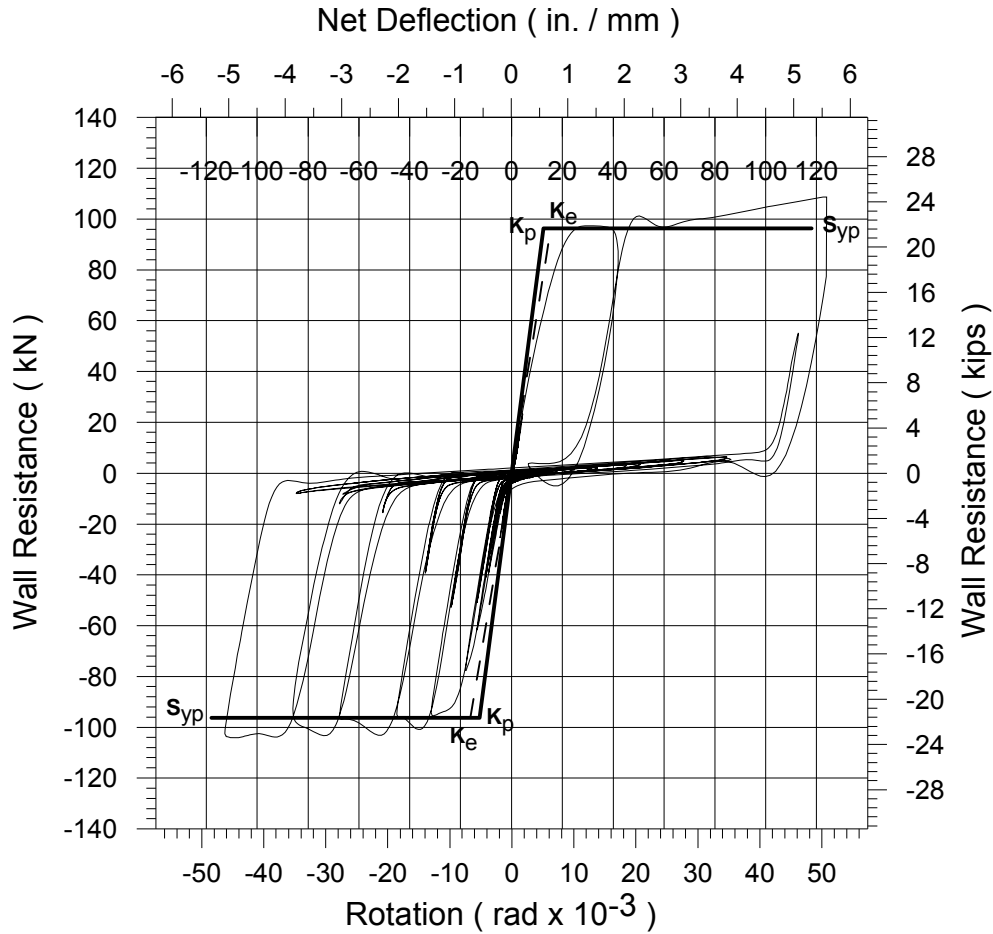

Figure A.23: Cyclic results for test 22A-C

Table A.17: Parameters for cyclic test 22A-C

Test Result	Parameters	Negative	Positive	Units		
	S_{max}	-104.12	108.72	kN		
	Δ_{max}	-112.67	123.92	mm		
	$S_{0.40}$	-41.65	43.49	kN		
	$\Delta_{0.40}$	-7.00	7.00	mm		
	K_e	5.95	6.21	kN/mm		
Ductility, μ	6.44	7.08	mm/mm			
Prediction (Actual Dimensions)	S_{yp}	-96.27	96.27	kN		
	K_p	7.68	7.68	kN/mm		
Prediction (Nominal Dimensions)	S_{yn}	-85.61	85.61	kN		
	K_n	7.47	7.47	kN/mm		
Strain Gauge Results						
Gauge	SG1	SG2	SG3	SG4	SG5	SG6
Max Strain (mm/mm)	15961	16480	13989	16547	15815	16723
Yielding Strain (mm/mm)	1906	1906	1906	1906	1906	1906
Yielding Status	OK	OK	OK	OK	OK	OK

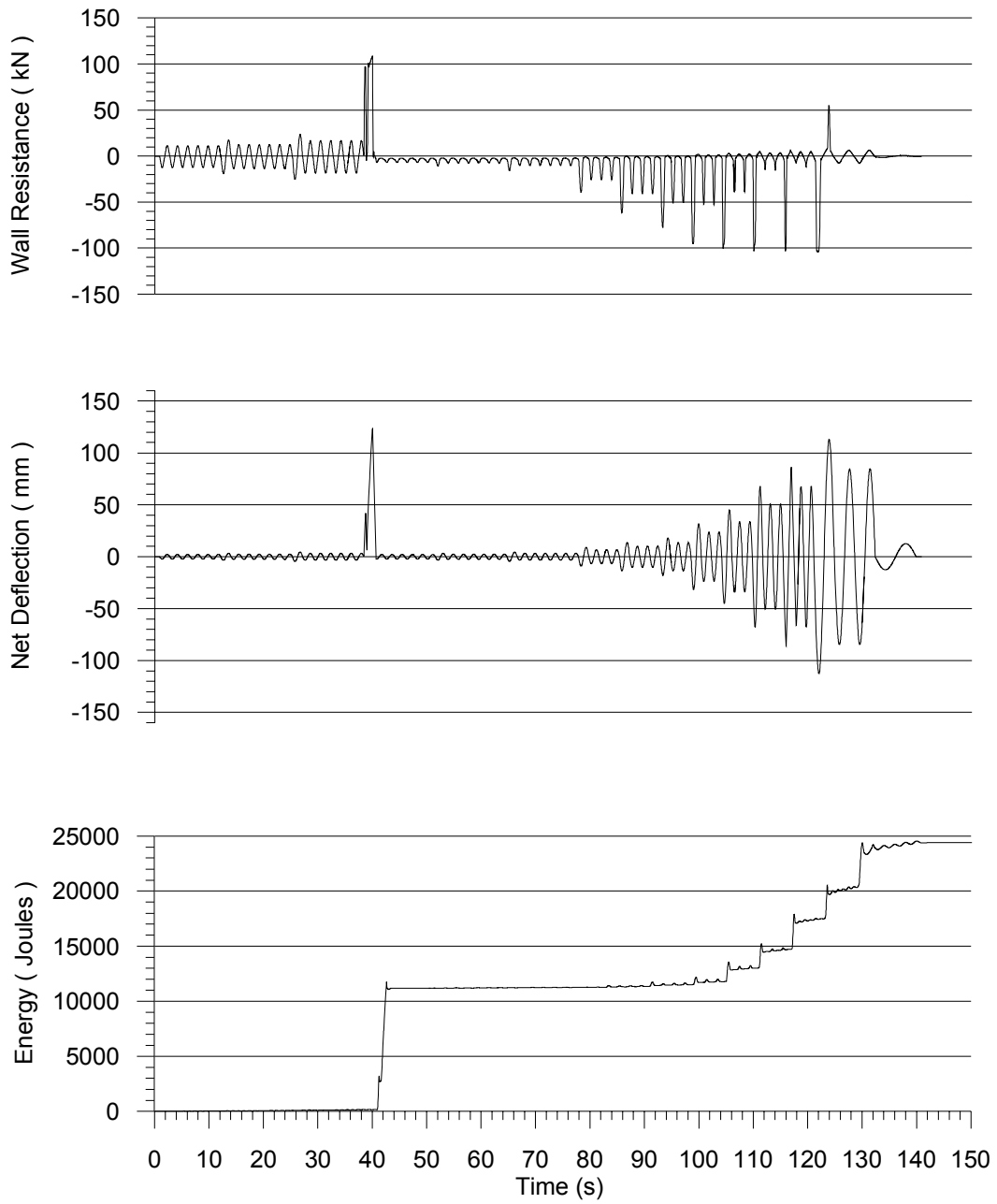

Figure A.24: Time history results for test 22A-C

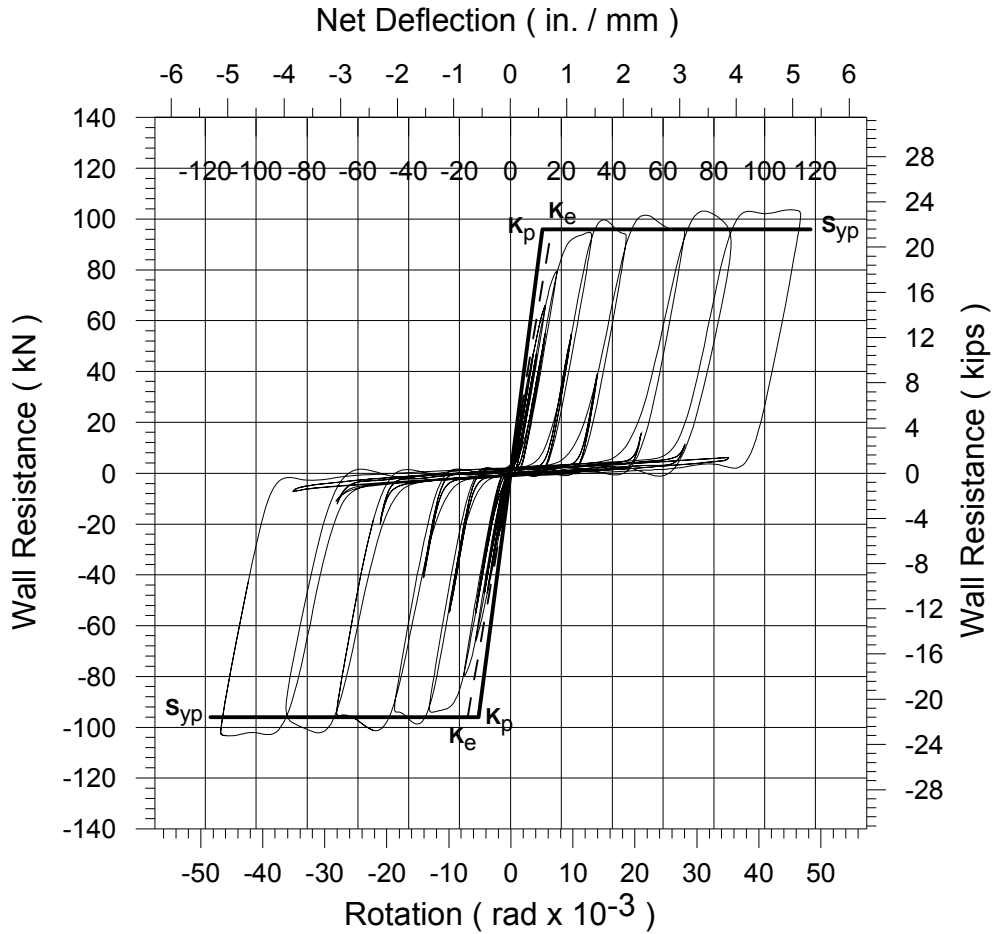

Figure A.25: Cyclic results for test 24A-C

Table A.18: Parameters for cyclic test 24A-C

Test Result	Parameters	Negative	Positive	Units		
	S_{max}	-103.38	103.66	kN		
Δ_{max}	-113.94	114.14	mm			
$S_{0.40}$	-41.35	41.46	kN			
$\Delta_{0.40}$	-7.26	7.00	mm			
K_e	5.70	5.92	kN/mm			
Ductility, μ	6.28	6.52	mm/mm			
Prediction (Actual Dimensions)	S_{yp}	-95.97	95.97	kN		
	K_p	7.67	7.67	kN/mm		
Prediction (Nominal Dimensions)	S_{yn}	-85.61	85.61	kN		
	K_n	7.47	7.47	kN/mm		
Strain Gauge Results						
Gauge	SG1	SG2	SG3	SG4	SG5	SG6
Max Strain (mm/mm)	16098	16063	16296	16133	16279	13397
Yielding Strain (mm/mm)	1906	1906	1906	1906	1906	1906
Yielding Status	OK	OK	OK	OK	OK	OK

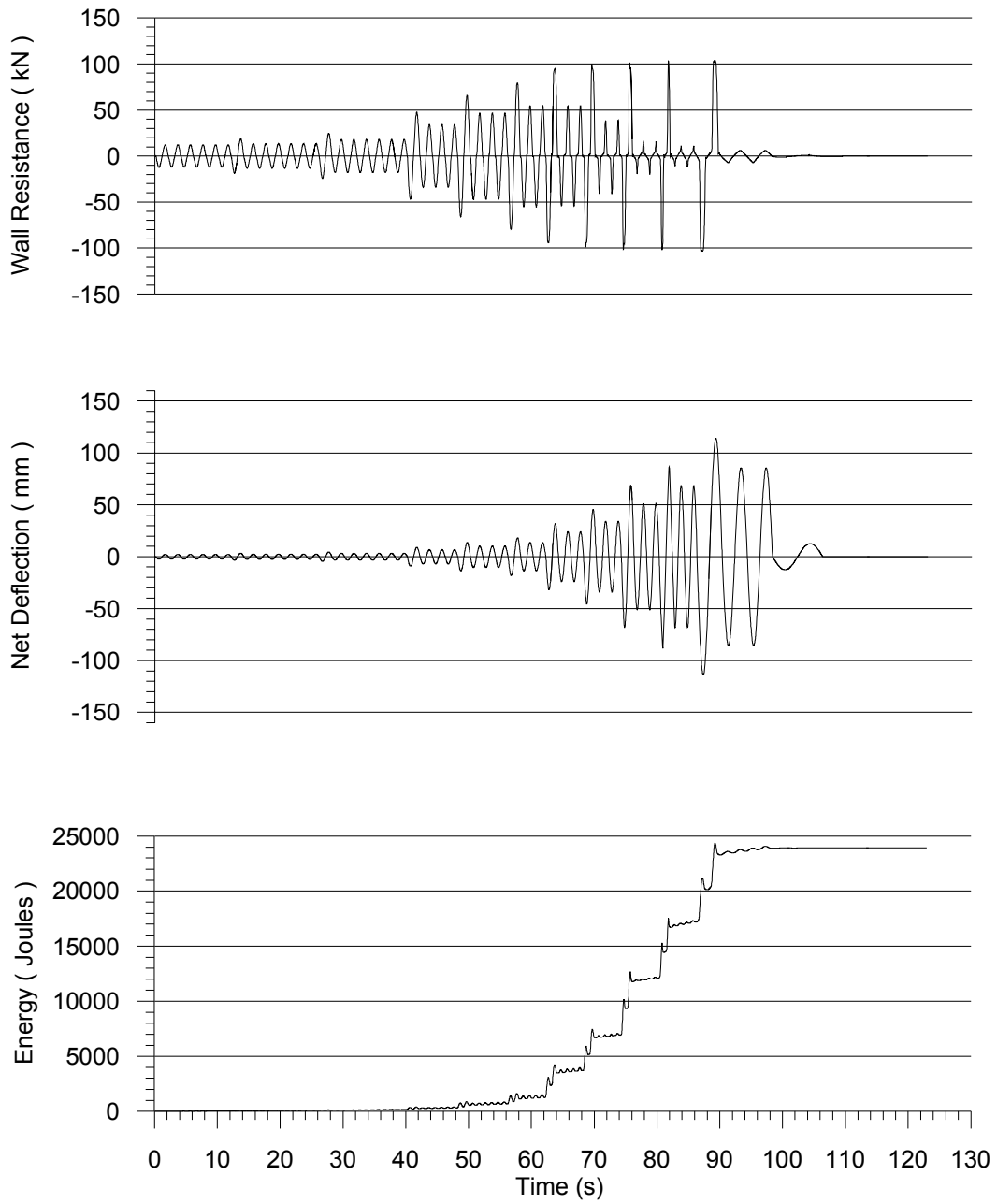

Figure A.26: Time history results for test 24A-C

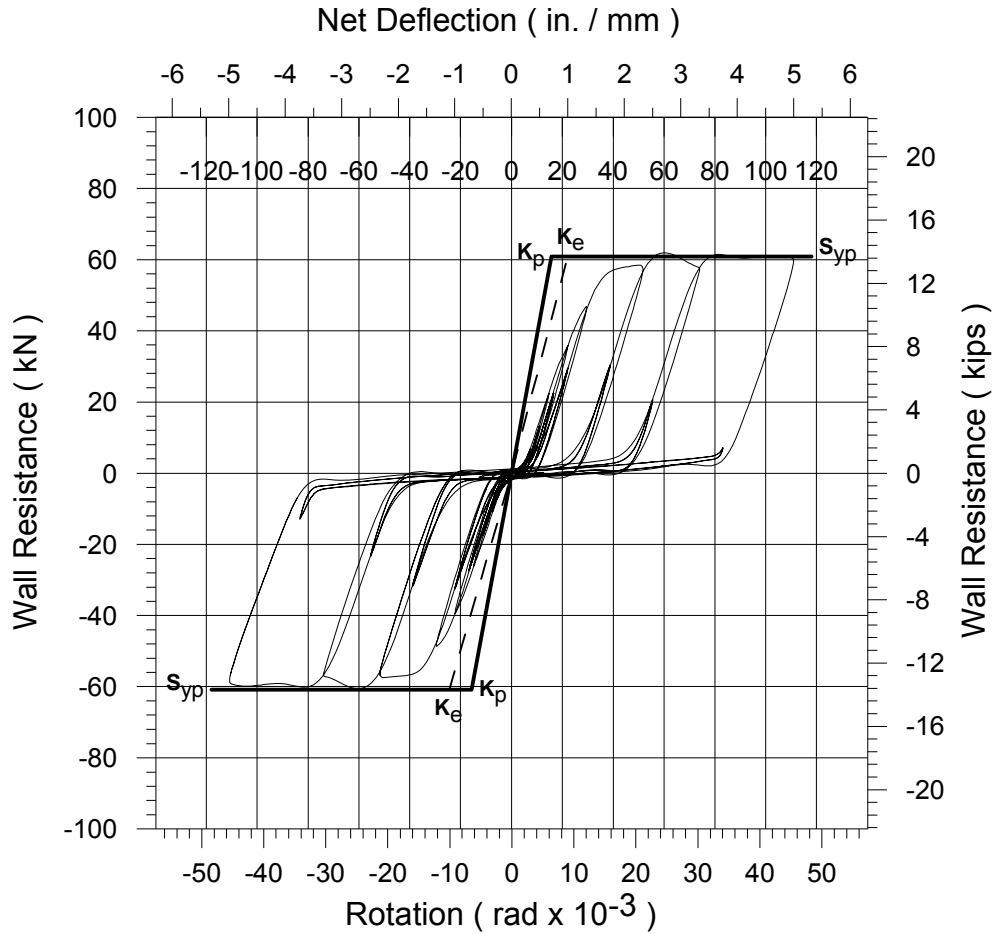

Figure A.27: Cyclic results for test 24B-C

Table A.19: Parameters for cyclic test 24B-C

Test Result	Parameters	Negative	Positive	Units		
	S_{max}		-60.57	61.97	kN	
Δ_{max}		-110.88	110.97	mm		
$S_{0.40}$		-23.62	24.79	kN		
$\Delta_{0.40}$		-9.50	9.00	mm		
K_e		2.49	2.75	kN/mm		
Ductility, μ		4.55	4.93	mm/mm		
Prediction (Actual Dimensions)	S_{yp}	-60.85	60.85	kN		
	K_p	3.87	3.87	kN/mm		
Prediction (Nominal Dimensions)	S_{yn}	-54.15	54.15	kN		
	K_n	3.77	3.77	kN/mm		
Strain Gauge Results						
Gauge	SG1	SG2	SG3	SG4	SG5	SG6
Max Strain (mm/mm)	15577	15430	12264	16170	13194	15787
Yielding Strain (mm/mm)	1906	1906	1906	1906	1906	1906
Yielding Status	OK	OK	OK	OK	OK	OK

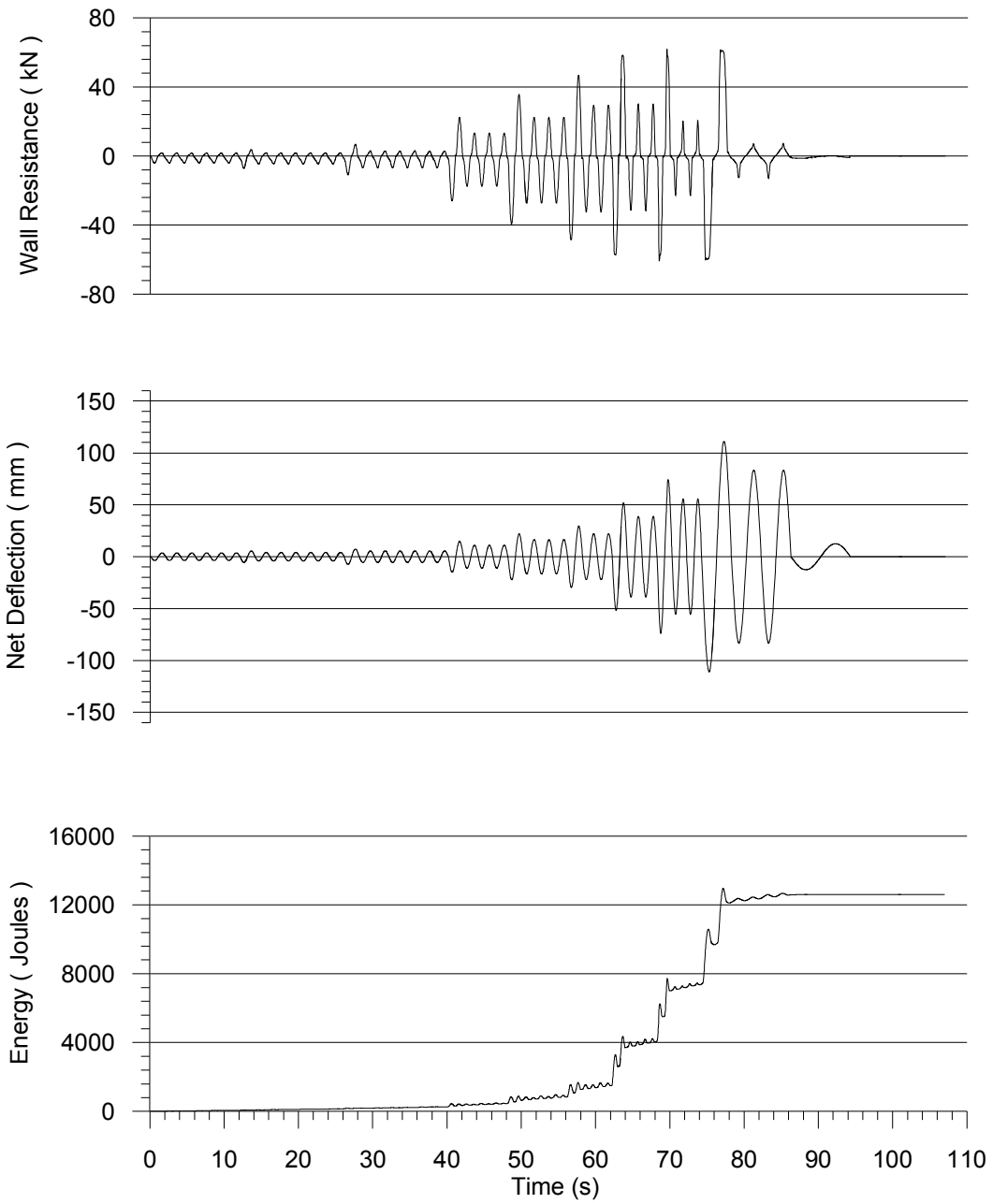

Figure A.28: Time history results for test 24B-C

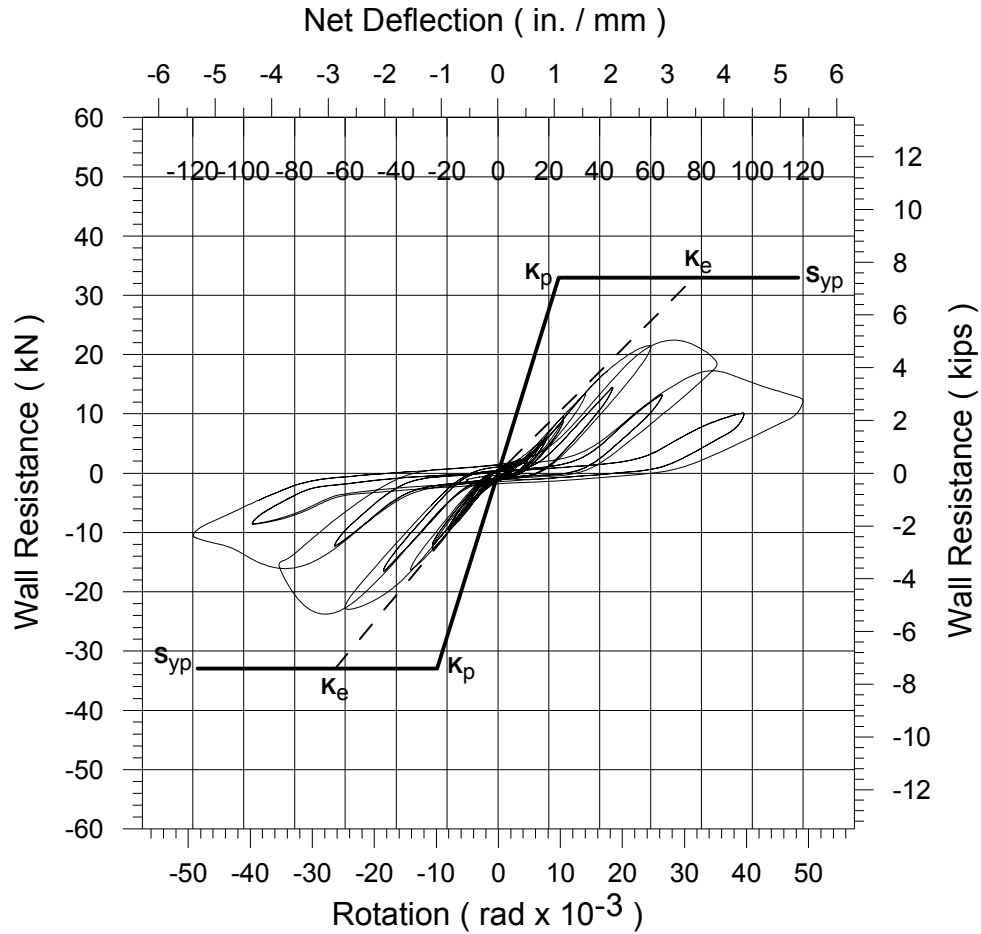

Figure A.29: Cyclic results for test 24C-C

Table A.20: Parameters for cyclic test 24C-C

Test Result	Parameters	Negative	Positive	Units		
	S_{max}	-23.76	22.44	kN		
Δ_{max}	-119.75	119.91	mm			
$S_{0.40}$	-9.27	8.98	kN			
$\Delta_{0.40}$	-18.00	21.00	mm			
K_e	0.51	0.43	kN/mm			
Ductility, μ	2.59	2.28	mm/mm			
Prediction (Actual Dimensions)	S_{yp}	-32.96	32.96	kN		
	K_p	1.38	1.38	kN/mm		
Prediction (Nominal Dimensions)	S_{yn}	-29.37	29.37	kN		
	K_n	1.34	1.34	kN/mm		
Strain Gauge Results						
Gauge	SG1	SG2	SG3	SG4	SG5	SG6
Max Strain (mm/mm)	1728	1675	1931	2082	2487	2541
Yielding Strain (mm/mm)	1906	1906	1906	1906	1906	1906
Yielding Status	NO YIELD	NO YIELD	OK	OK	OK	OK

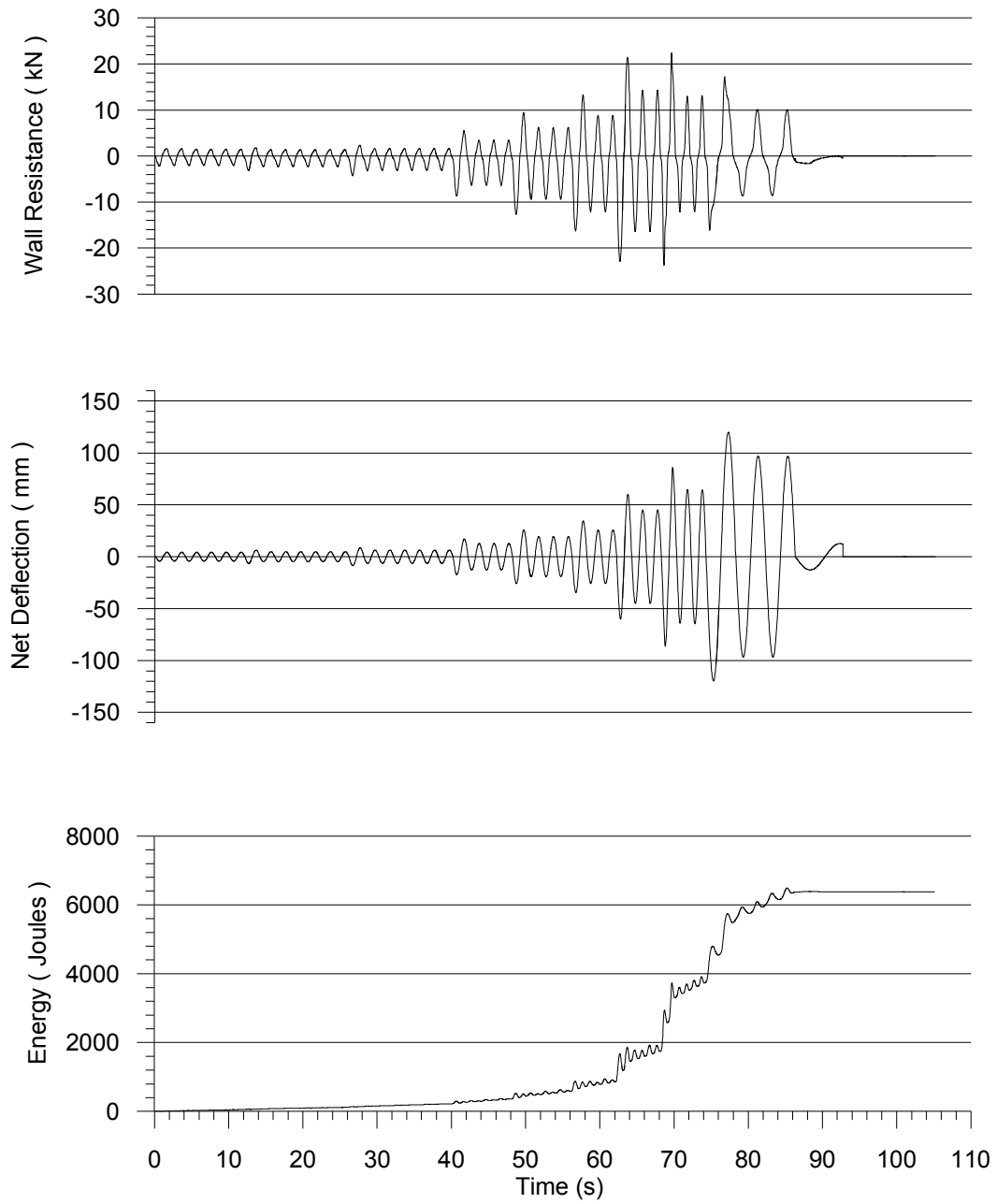

Figure A.30: Time history results for test 24C-C

Appendix B

Nominal Dimensions and Specifications of All Walls

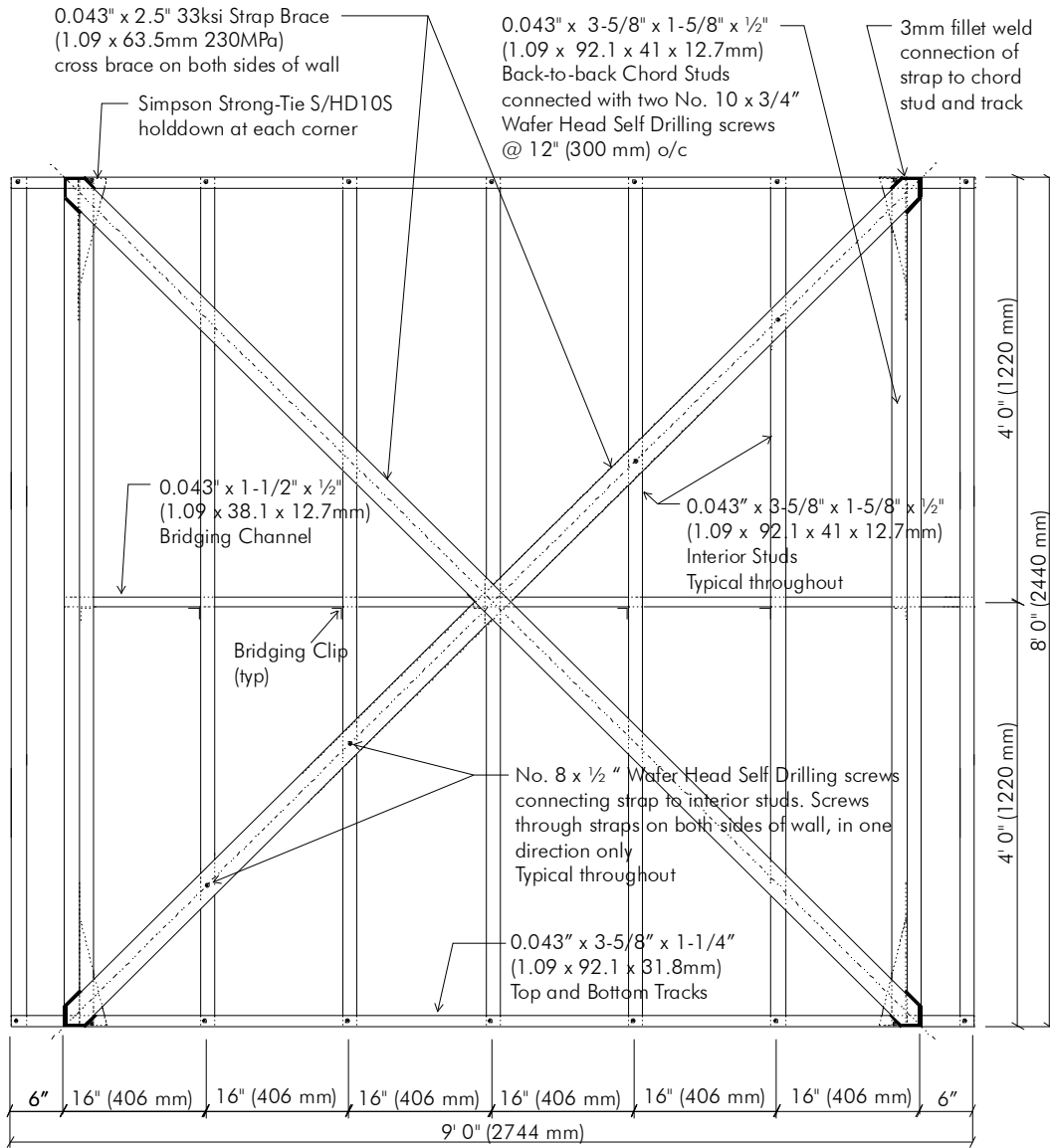

Figure B.31: Nominal dimensions and specifications of walls 13A-M and 14A-C

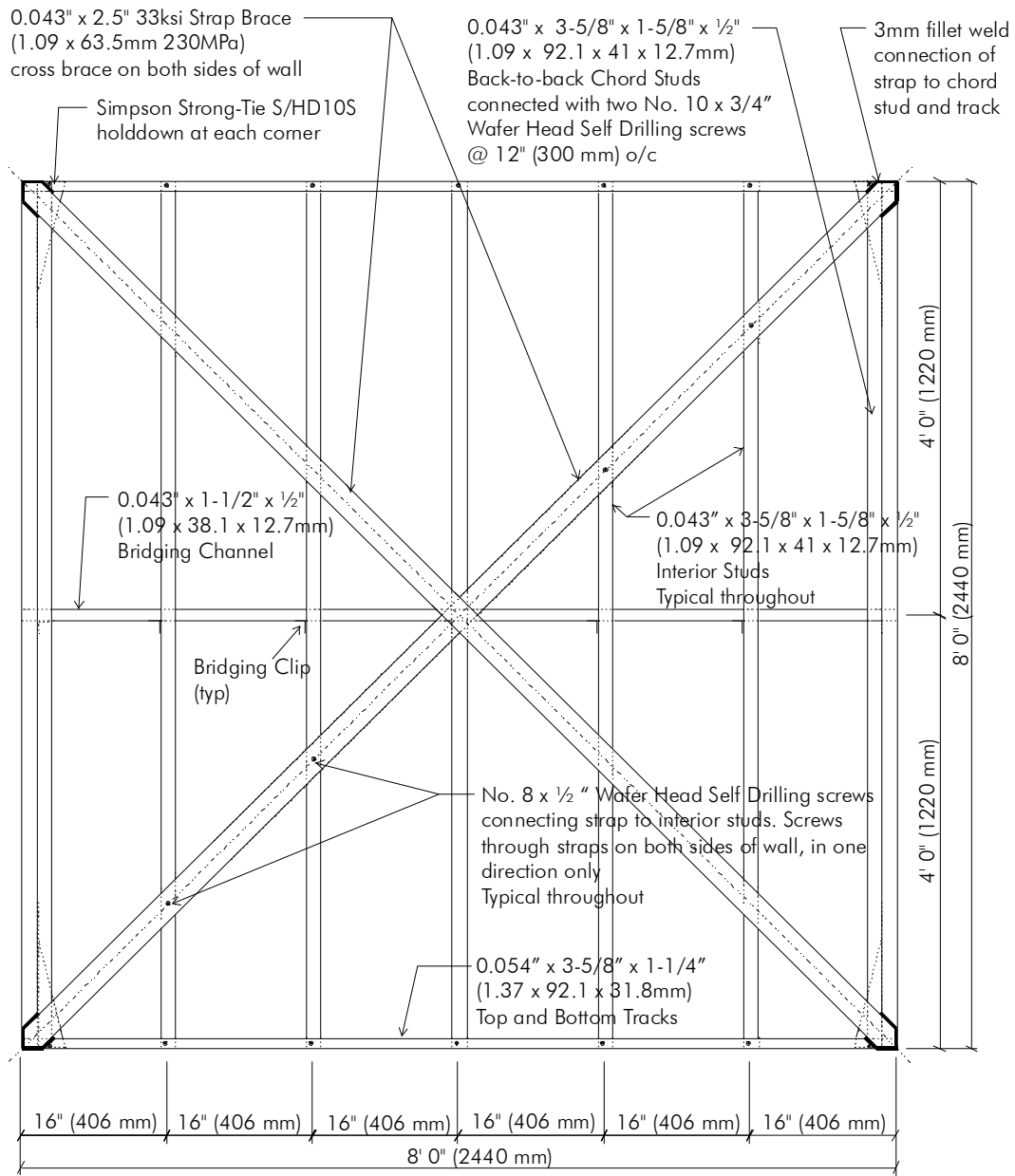

Figure B.32: Nominal dimensions and specifications of walls 15A-M and 16A-C

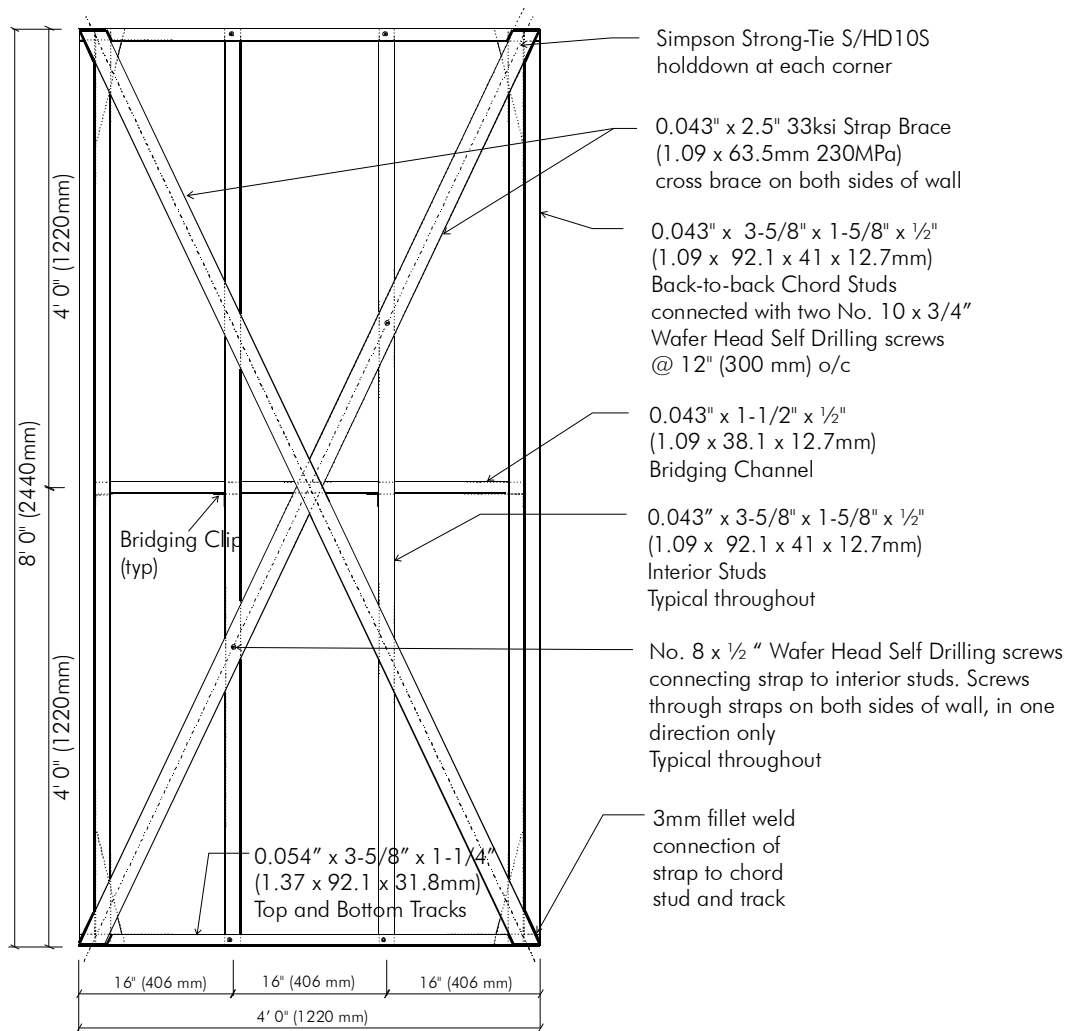

Figure B.33: Nominal dimensions and specifications for walls 15B-M and 16B-C

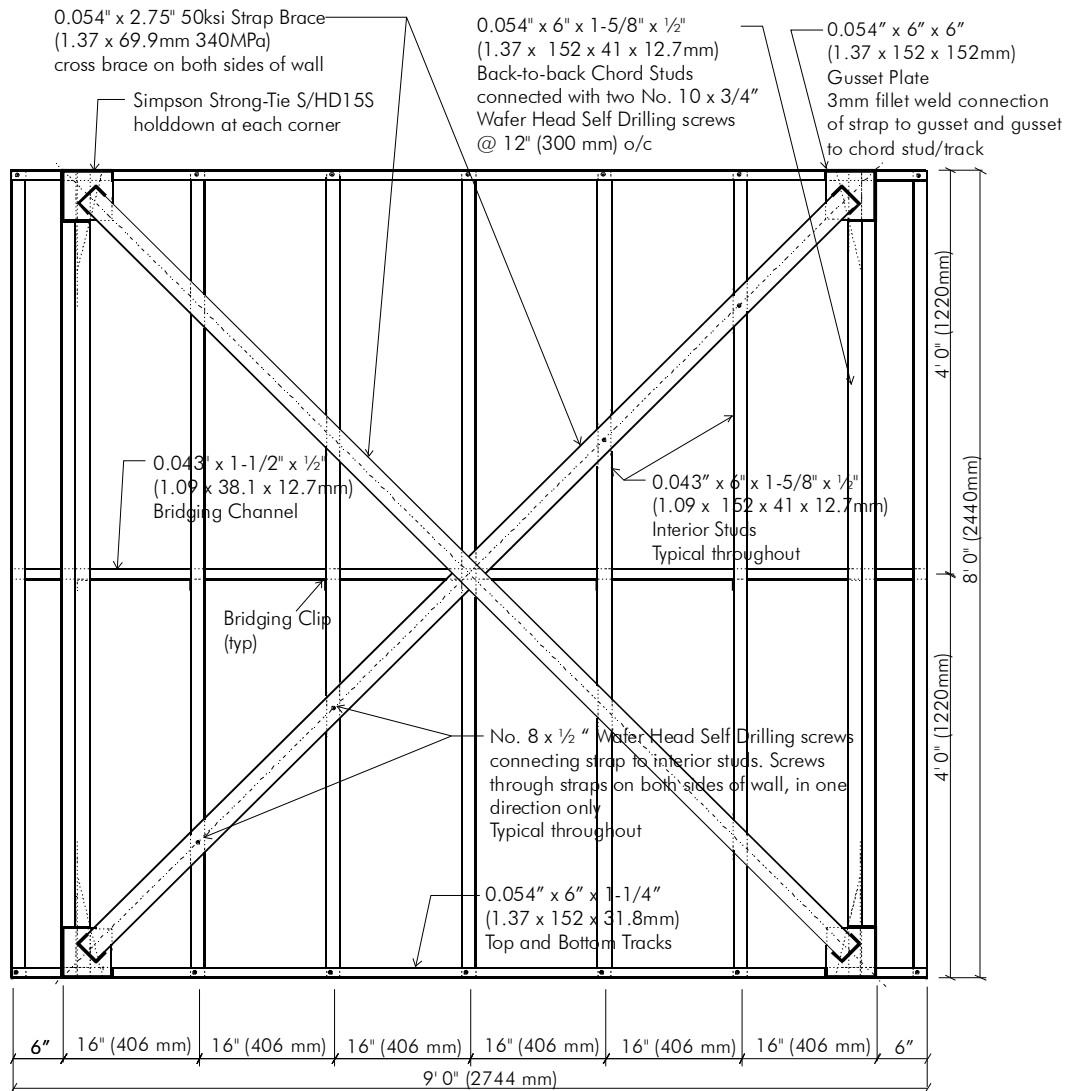

Figure B.34: Nominal dimensions and specifications for walls 17A-M and 18A-C

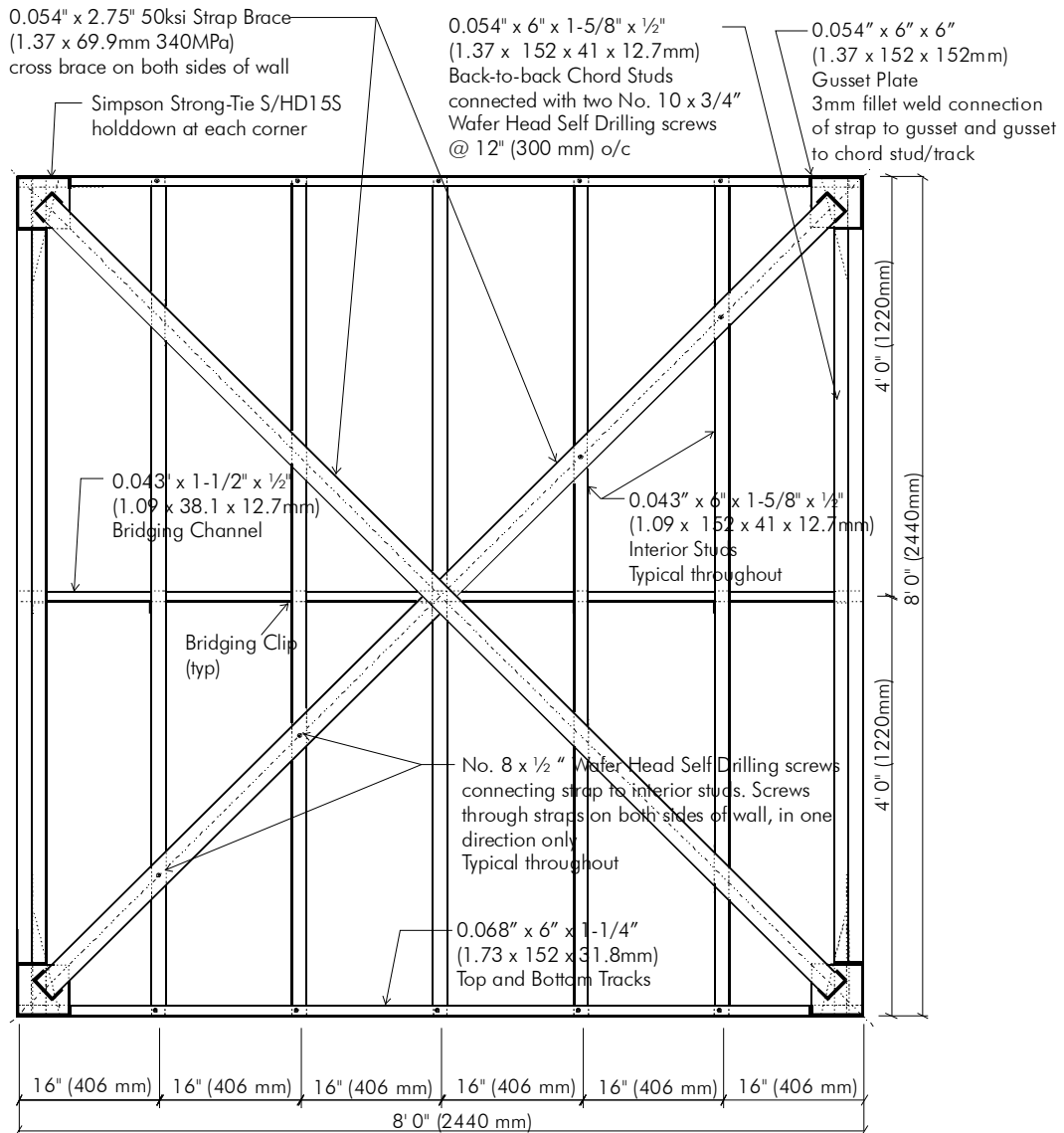

Figure B.35: Nominal dimensions and specifications for walls 19A-M and 20A-C

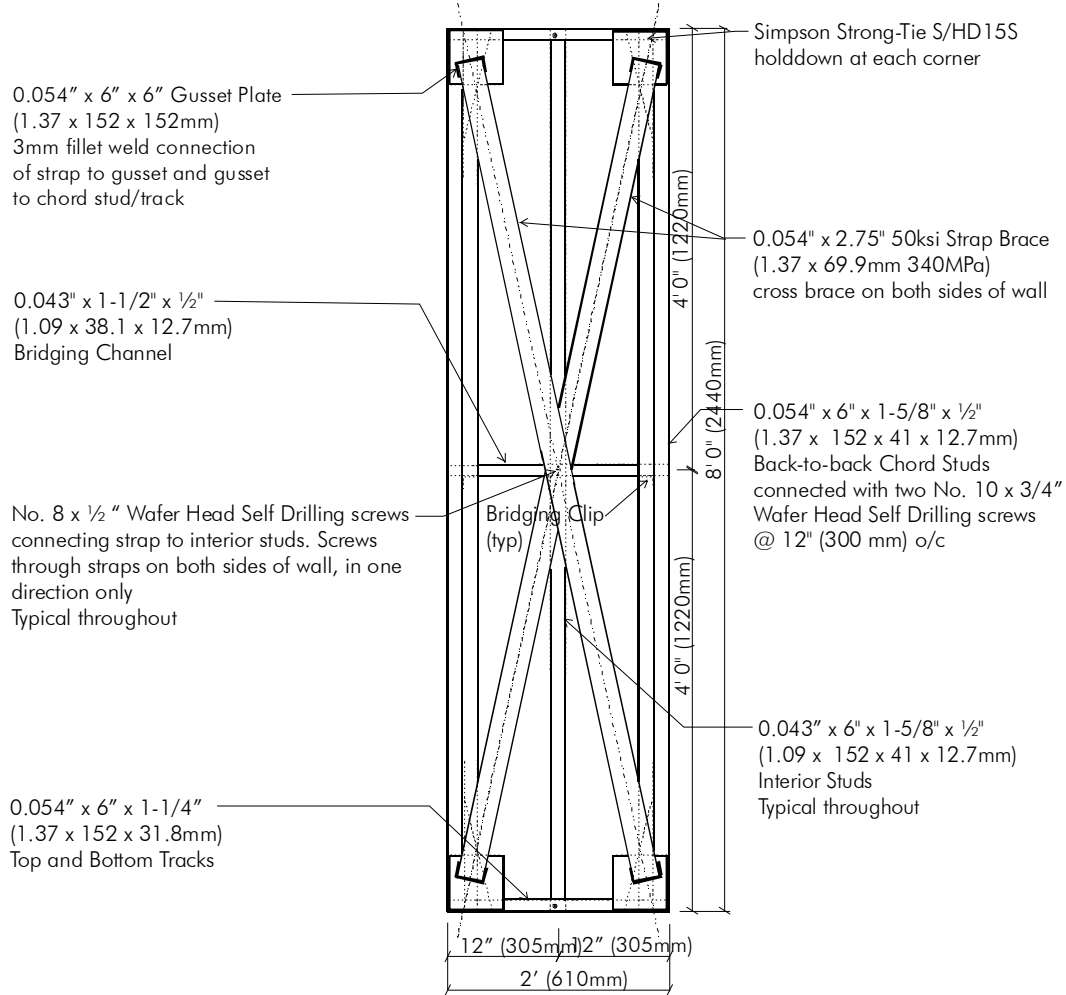

Figure B.36: Nominal dimensions and specifications for walls 19B-M and 20B-C

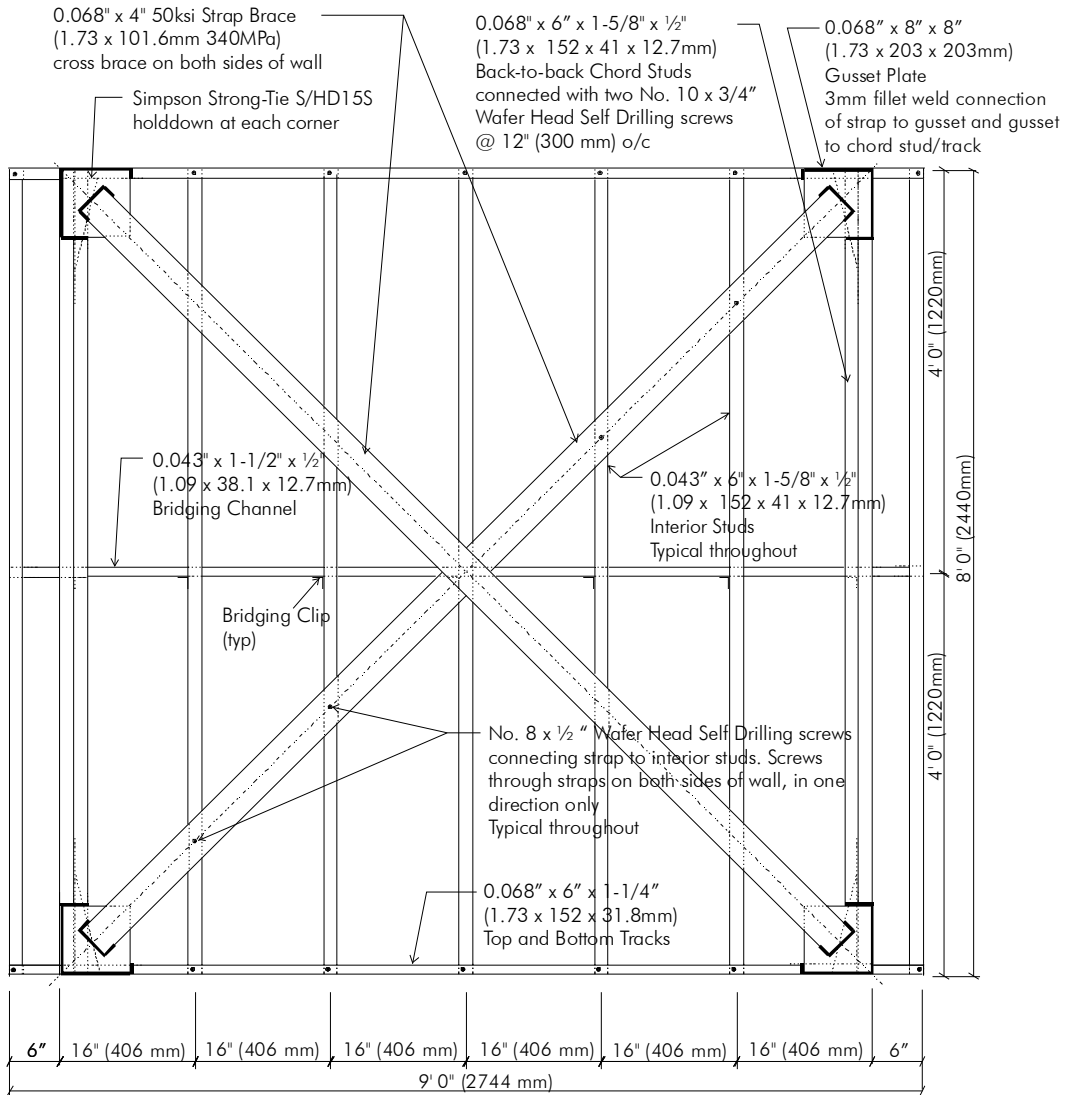

Figure B.37: Nominal dimensions and specifications for walls 21A-M and 22A-C

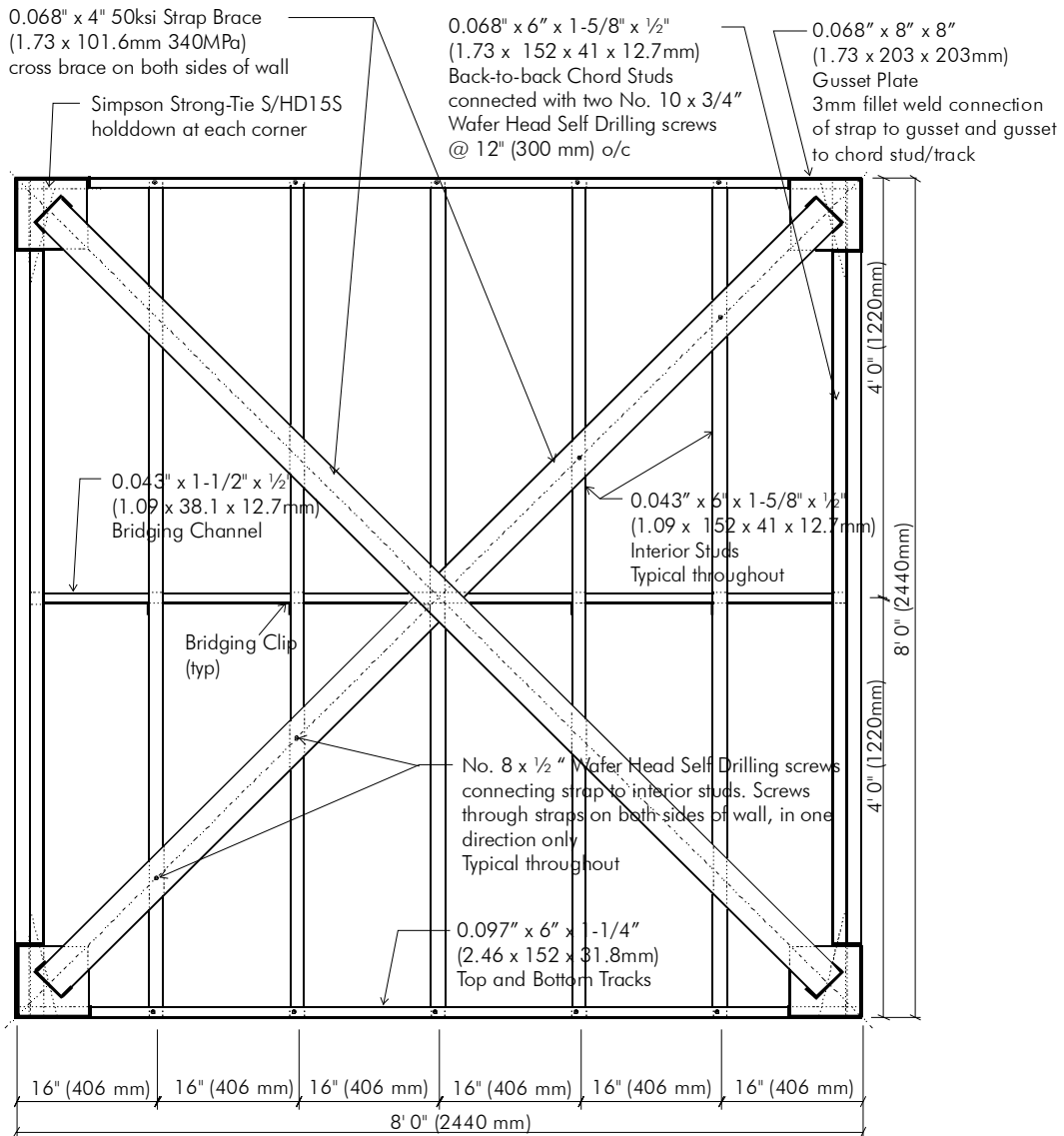

Figure B.38: Nominal dimensions and specifications for walls 23A-M and 24A-C

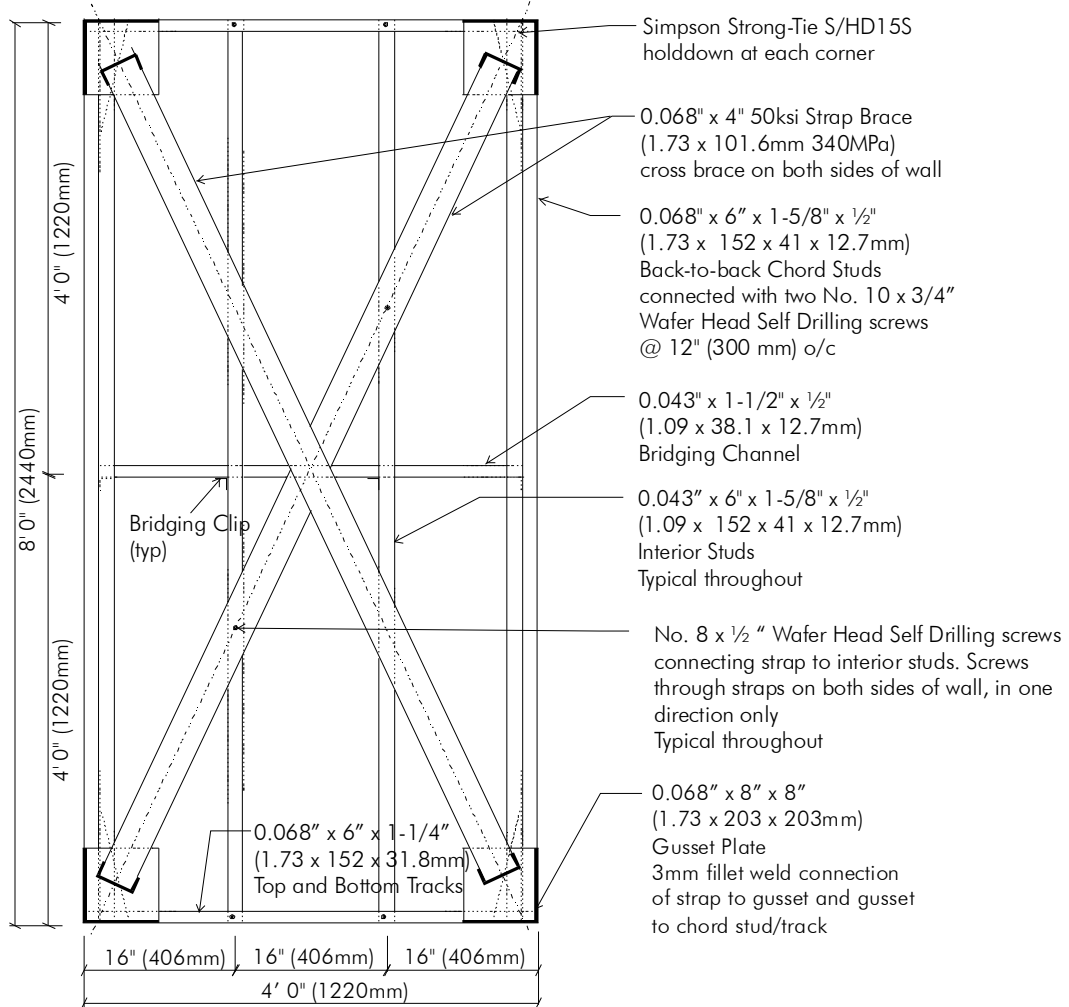

Figure B.39: Nominal dimensions and specifications for walls 23B-M and 24B-C

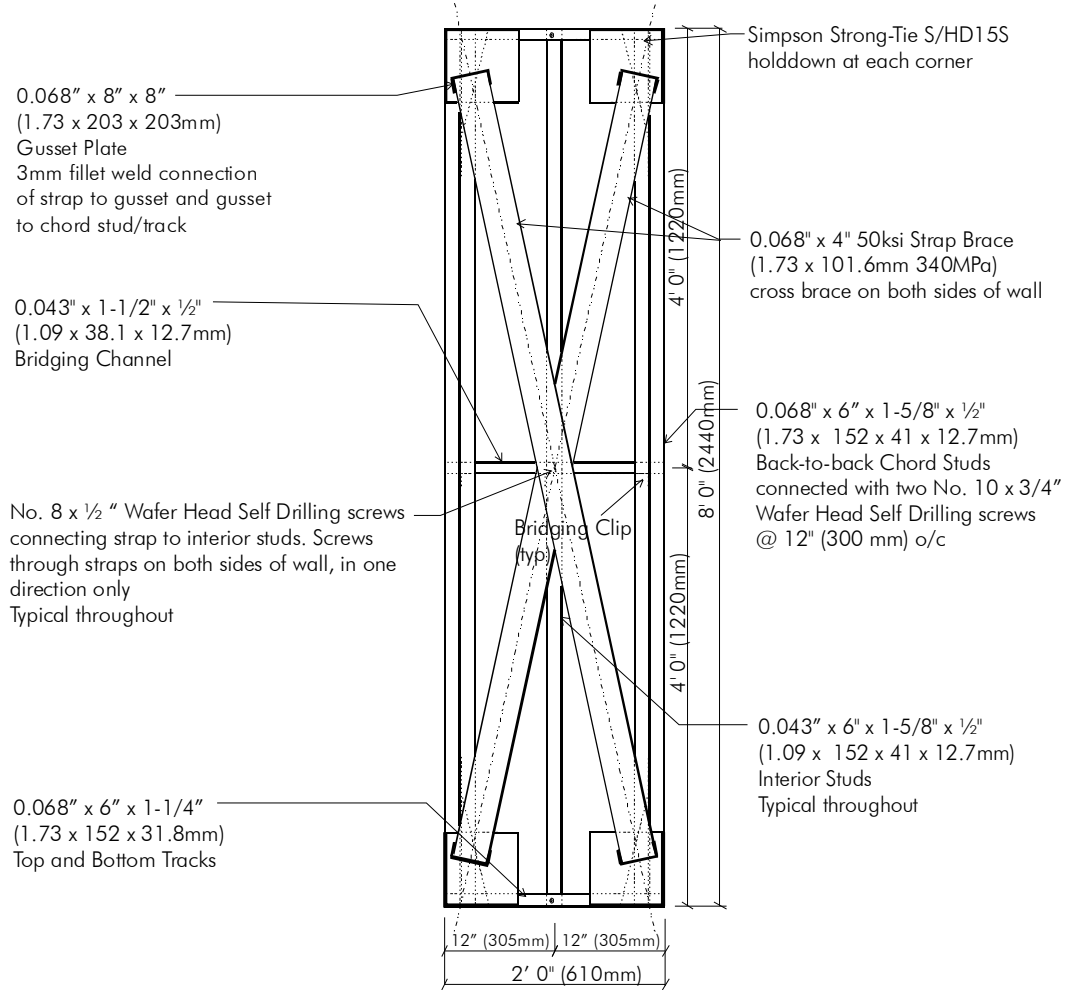

Figure B.40: Nominal dimensions and specifications for walls 23C-M and 24C-C

Appendix C

Strain Gauge Locations

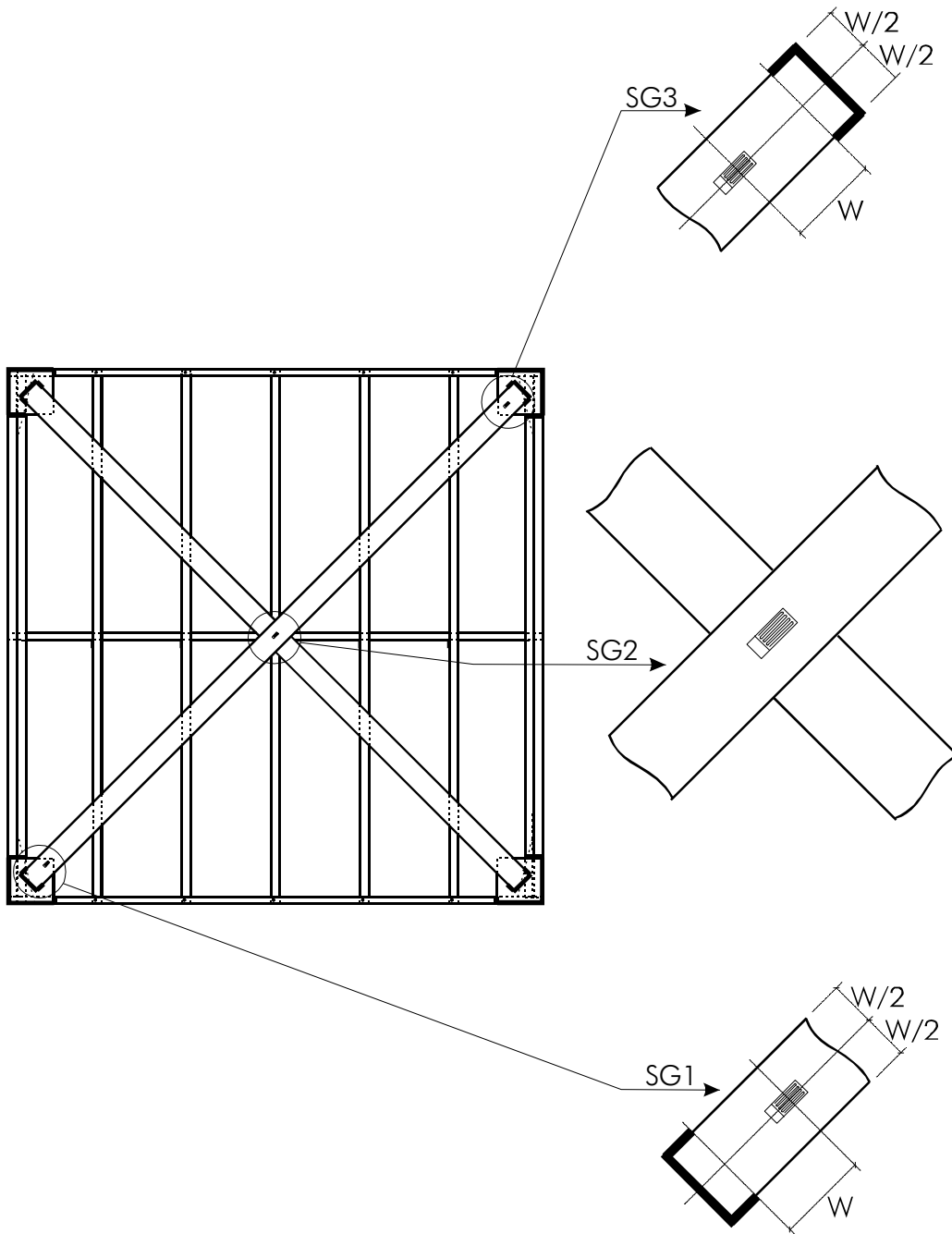

Figure C.1: Strain gauge locations for monotonic tests, 'pull' walls

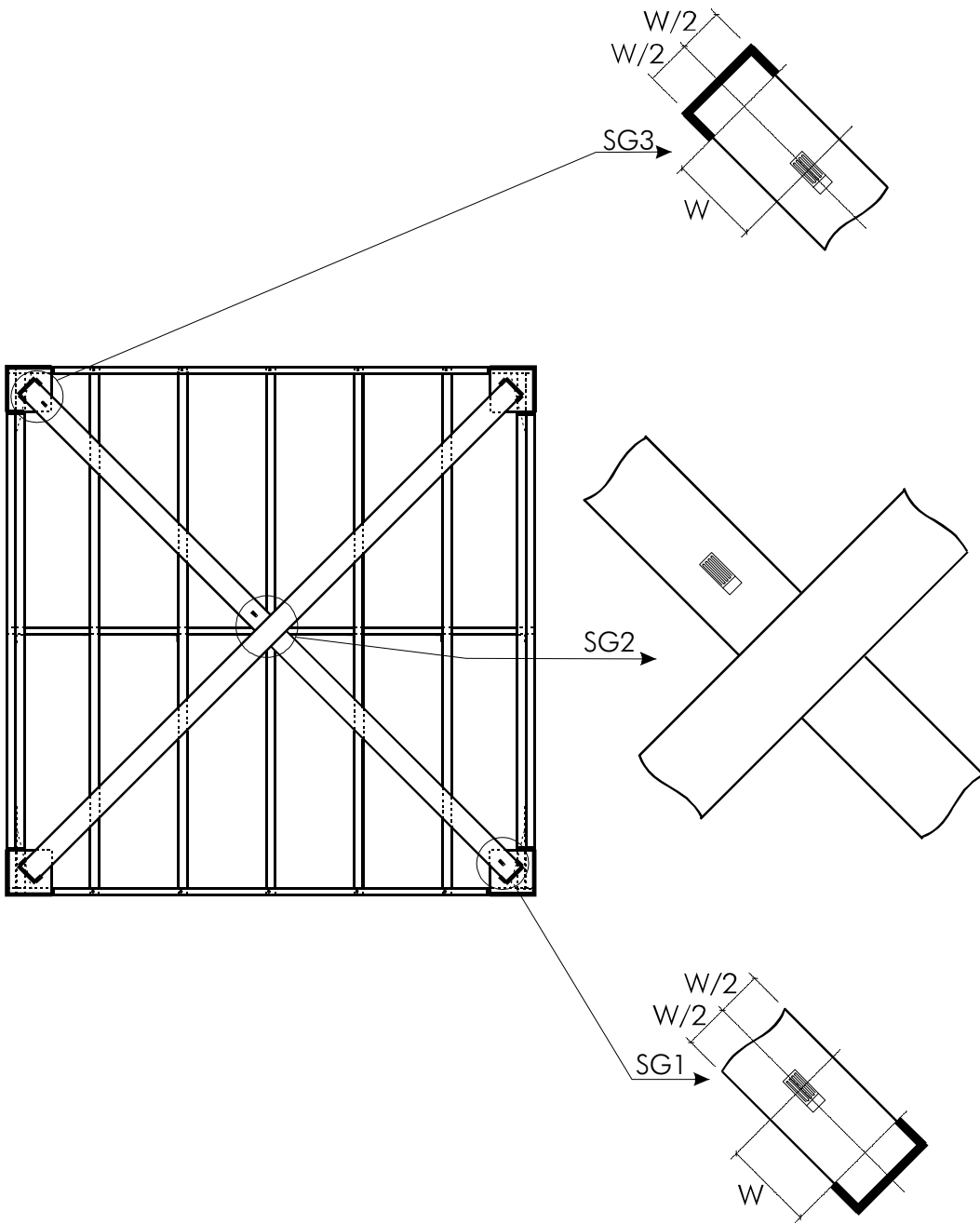

Figure C.2: Strain gauge locations for monotonic tests, 'push' walls

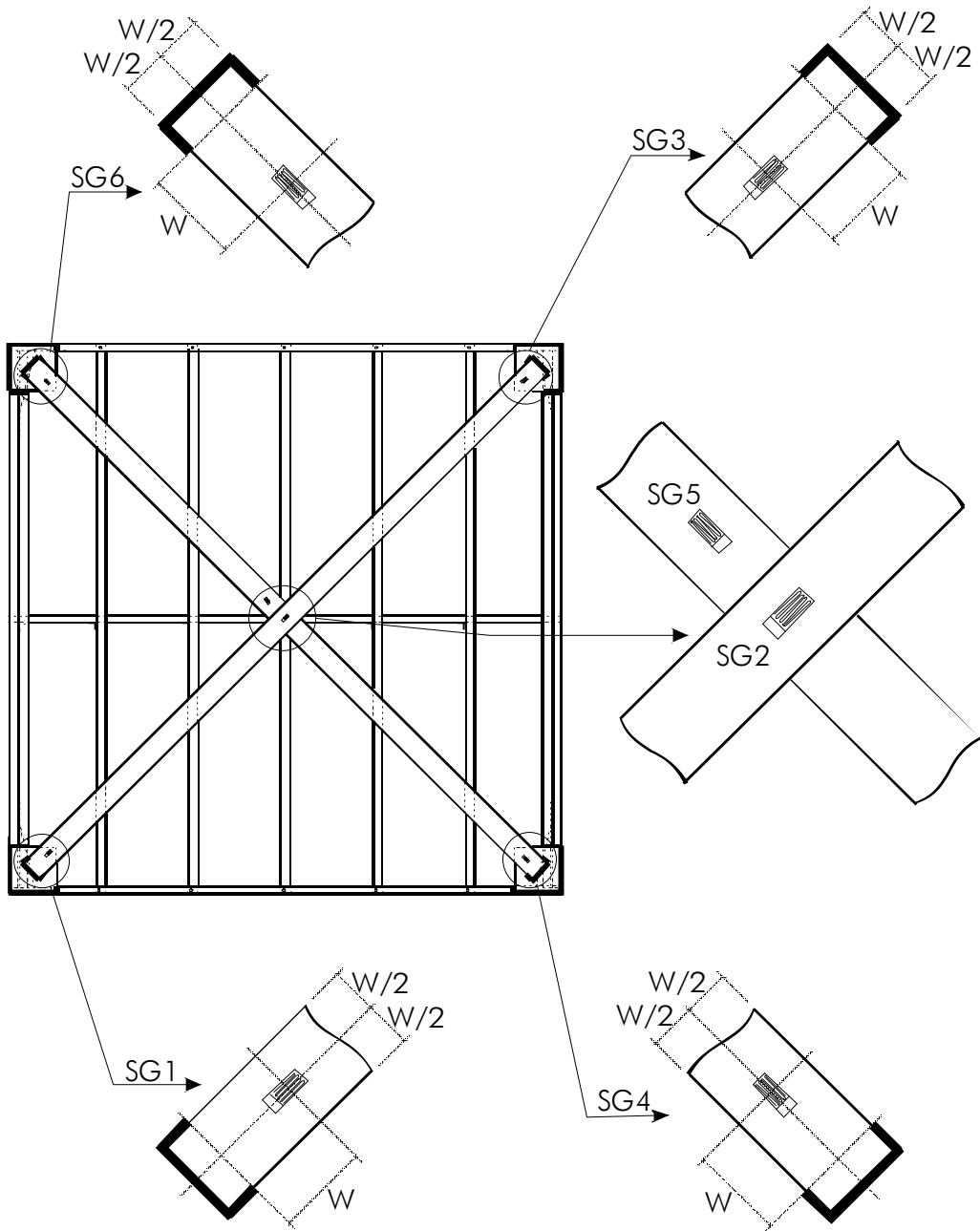

Figure C.3: Strain gauge locations for cyclic tests

Appendix D

Reversed Cyclic Test Protocols

Table D.1: CUREE reversed cyclic protocol for test 14A-C

Cycle Displacement	Number of Cycles	Target Displacement (mm)	Actuator Input (mm)	Frequency (Hz)
0.050 Δ	6	1.534	1.587	0.5 Hz
0.075 Δ	1	2.300	2.381	
0.056 Δ	6	1.718	1.778	
0.100 Δ	1	3.067	3.175	
0.075 Δ	6	2.300	2.381	
0.200 Δ	1	6.135	6.349	
0.150 Δ	3	4.601	4.762	
0.300 Δ	1	9.202	9.524	
0.225 Δ	3	6.901	7.143	
0.400 Δ	1	12.269	12.698	
0.300 Δ	2	9.202	9.524	
0.700 Δ	1	21.471	22.222	
0.525 Δ	2	16.103	16.667	
1.000 Δ	1	30.673	31.746	
0.750 Δ	2	23.005	23.810	
1.500 Δ	1	46.010	47.619	
1.125 Δ	2	34.507	35.714	
2.000 Δ	1	61.346	63.492	
1.500 Δ	2	46.010	47.619	
2.500 Δ	1	76.683	79.365	
1.875 Δ	2	57.512	59.524	
3.000 Δ	1	92.019	95.239	
2.250 Δ	2	69.015	71.429	
3.500 Δ	1	107.356	111.112	0.25 Hz
2.625 Δ	2	80.517	83.334	

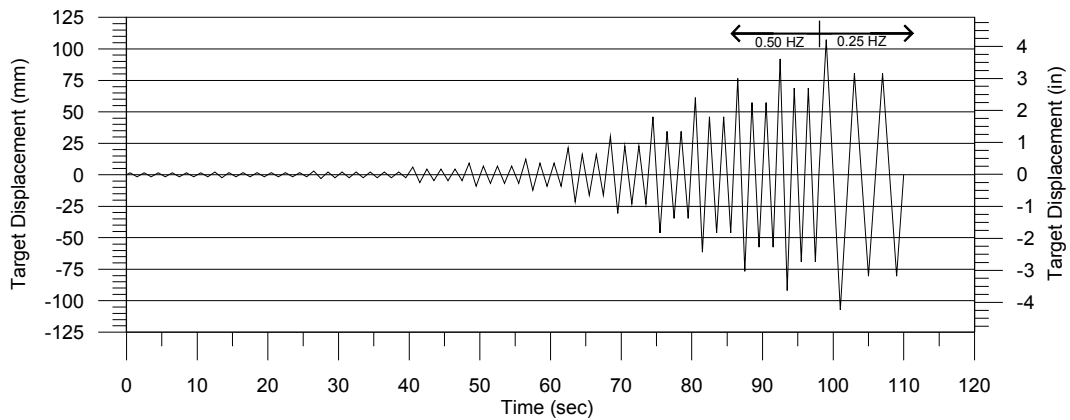

Figure D.1: CUREE reversed cyclic protocol for test 14A-C

Table D.2: CUREE reversed cyclic protocol for test 16A-C

Cycle Displacement	Number of Cycles	Target Displacement (mm)	Actuator Input (mm)	Frequency (Hz)
0.050 Δ	6	1.766	1.778	0.5 Hz
0.075 Δ	1	2.649	2.667	
0.056 Δ	6	1.978	1.991	
0.100 Δ	1	3.532	3.556	
0.075 Δ	6	2.649	2.667	
0.200 Δ	1	7.065	7.112	
0.150 Δ	3	5.298	5.334	
0.300 Δ	1	10.597	10.667	
0.225 Δ	3	7.948	8.000	
0.400 Δ	1	14.129	14.223	
0.300 Δ	2	10.597	10.667	
0.700 Δ	1	24.726	24.890	
0.525 Δ	2	18.544	18.668	
1.000 Δ	1	35.323	35.558	
0.750 Δ	2	26.492	26.668	
1.500 Δ	1	52.984	53.336	
1.125 Δ	2	39.738	40.002	
2.000 Δ	1	70.646	71.115	
1.500 Δ	2	52.984	53.336	
2.500 Δ	1	88.307	88.894	
1.875 Δ	2	66.230	66.670	
3.000 Δ	1	105.969	106.673	0.25 Hz
2.250 Δ	2	79.476	80.004	
3.500 Δ	1	123.630	124.451	
2.625 Δ	2	92.722	93.339	

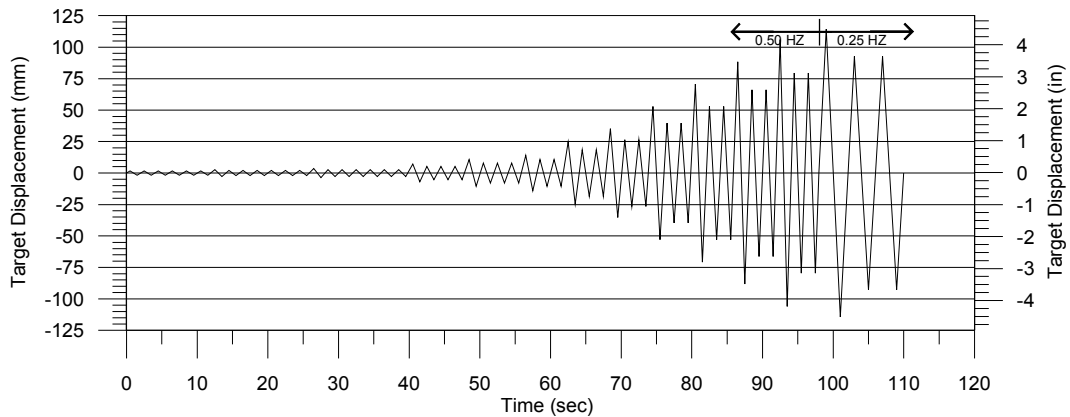

Figure D.2: CUREE reversed cyclic protocol for test 16A-C

Table D.3: CUREE reversed cyclic protocol for test 16B-C

Cycle Displacement	Number of Cycles	Target Displacement (mm)	Actuator Input (mm)	Frequency (Hz)
0.050 Δ	6	3.733	3.767	0.5 Hz
0.075 Δ	1	5.599	5.650	
0.056 Δ	6	4.181	4.219	
0.100 Δ	1	7.465	7.534	
0.075 Δ	6	5.599	5.650	
0.200 Δ	1	14.931	15.068	
0.150 Δ	3	11.198	11.301	
0.300 Δ	1	22.396	22.602	
0.225 Δ	3	16.797	16.951	
0.400 Δ	1	29.861	30.136	
0.300 Δ	2	22.396	22.602	
0.700 Δ	1	52.257	52.737	
0.525 Δ	2	39.193	39.553	
1.000 Δ	1	74.653	75.339	
0.750 Δ	2	55.990	56.504	
1.500 Δ	1	111.980	113.008	
1.125 Δ	2	83.985	84.756	

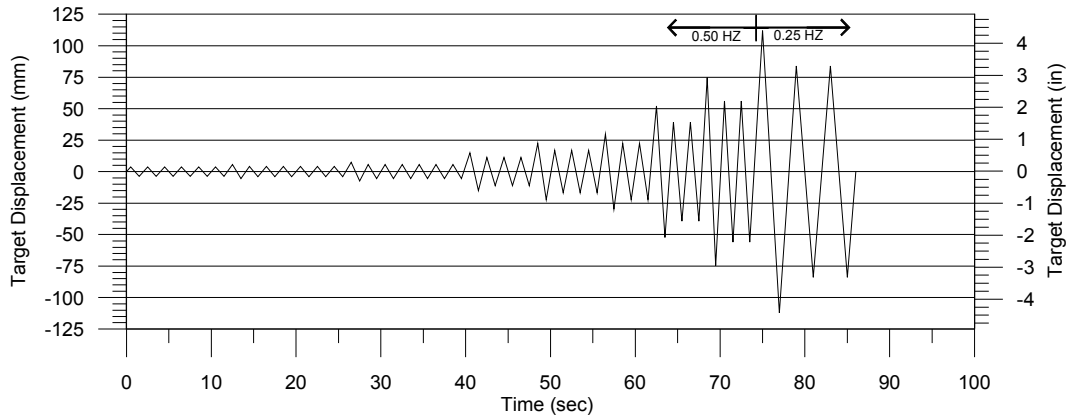

Figure D.3: CUREE reversed cyclic protocol for test 16B-C

Table D.4: CUREE reversed cyclic protocol for test 18A-C

Cycle Displacement	Number of Cycles	Target Displacement (mm)	Actuator Input (mm)	Frequency (Hz)
0.050 Δ	6	2.236	2.296	0.5 Hz
0.075 Δ	1	3.354	3.444	
0.056 Δ	6	2.505	2.571	
0.100 Δ	1	4.472	4.592	
0.075 Δ	6	3.354	3.444	
0.200 Δ	1	8.945	9.183	
0.150 Δ	3	6.709	6.888	
0.300 Δ	1	13.417	13.775	
0.225 Δ	3	10.063	10.331	
0.400 Δ	1	17.890	18.367	
0.300 Δ	2	13.417	13.775	
0.700 Δ	1	31.307	32.142	
0.525 Δ	2	23.480	24.107	
1.000 Δ	1	44.724	45.917	
0.750 Δ	2	33.543	34.438	
1.500 Δ	1	67.086	68.876	
1.125 Δ	2	50.314	51.657	
2.000 Δ	1	89.448	91.835	
1.500 Δ	2	67.086	68.876	0.25 Hz
2.500 Δ	1	111.810	114.793	
1.875 Δ	2	83.857	86.095	

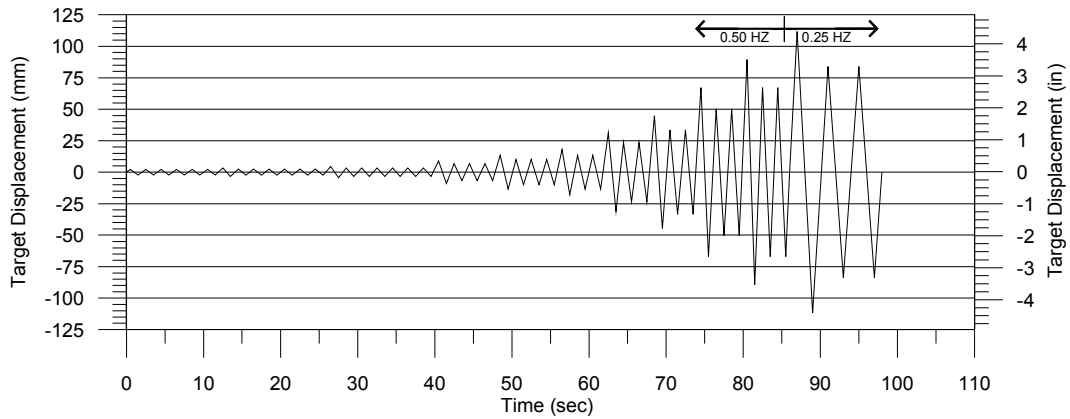

Figure D.4: CUREE reversed cyclic protocol for test 18A-C

Table D.5: CUREE reversed cyclic protocol for test 20A-C

Cycle Displacement	Number of Cycles	Target Displacement (mm)	Actuator Input (mm)	Frequency (Hz)
0.050 Δ	6	2.134	2.214	0.5 Hz
0.075 Δ	1	3.201	3.321	
0.056 Δ	6	2.390	2.480	
0.100 Δ	1	4.268	4.428	
0.075 Δ	6	3.201	3.321	
0.200 Δ	1	8.537	8.856	
0.150 Δ	3	6.402	6.642	
0.300 Δ	1	12.805	13.285	
0.225 Δ	3	9.604	9.963	
0.400 Δ	1	17.073	17.713	
0.300 Δ	2	12.805	13.285	
0.700 Δ	1	29.878	30.997	
0.525 Δ	2	22.409	23.248	
1.000 Δ	1	42.683	44.282	
0.750 Δ	2	32.012	33.211	
1.500 Δ	1	64.025	66.423	
1.125 Δ	2	48.019	49.817	
2.000 Δ	1	85.367	88.564	
1.500 Δ	2	64.025	66.423	0.25 Hz
2.500 Δ	1	106.708	110.705	
1.875 Δ	2	80.031	83.029	

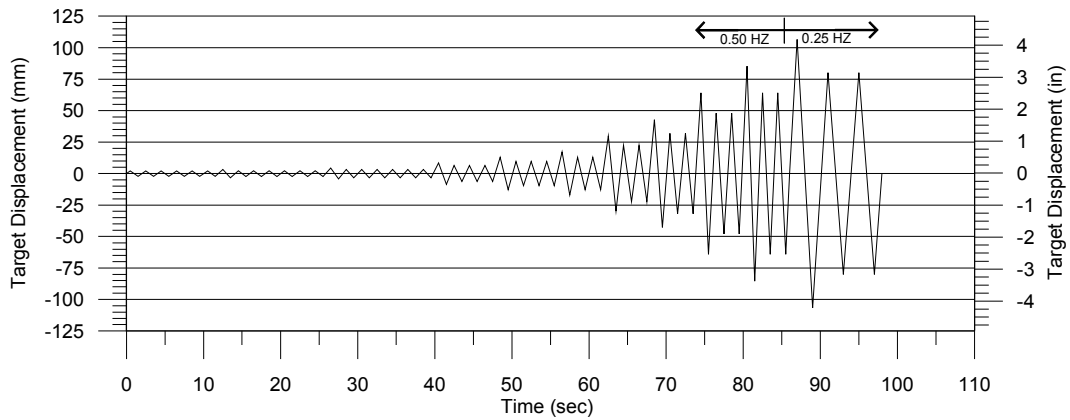

Figure D.5: CUREE reversed cyclic protocol for test 20A-C

Table D.6: CUREE reversed cyclic protocol for test 20B-C

Cycle Displacement	Number of Cycles	Target Displacement (mm)	Actuator Input (mm)	Frequency (Hz)
0.050 Δ	6	4.200	4.256	0.5 Hz
0.075 Δ	1	6.300	6.384	
0.056 Δ	6	4.704	4.767	
0.100 Δ	1	8.400	8.512	
0.075 Δ	6	6.300	6.384	
0.200 Δ	1	16.800	17.024	
0.150 Δ	3	12.600	12.768	
0.300 Δ	1	25.200	25.536	
0.225 Δ	3	18.900	19.152	
0.400 Δ	1	33.600	34.047	
0.300 Δ	2	25.200	25.536	
0.700 Δ	1	58.800	59.583	
0.525 Δ	2	44.100	44.687	
1.000 Δ	1	84.000	85.119	
0.750 Δ	2	63.000	63.839	0.25 Hz
1.500 Δ	1	123.357	125.000	
1.125 Δ	2	94.500	95.758	

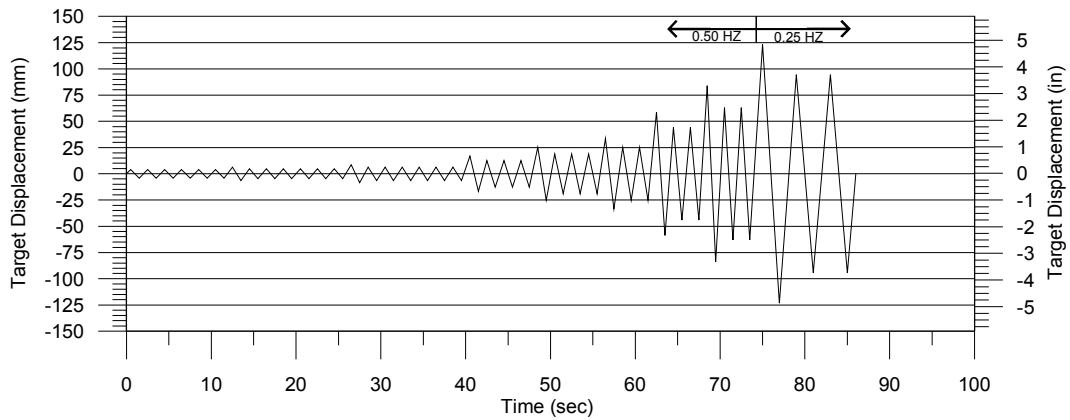

Figure D.6: CUREE reversed cyclic protocol for test 20B-C

Table D.7: CUREE reversed cyclic protocol for test 22A-C

Cycle Displacement	Number of Cycles	Target Displacement (mm)	Actuator Input (mm)	Frequency (Hz)
0.050 Δ	6	2.206	2.317	0.5 Hz
0.075 Δ	1	3.309	3.475	
0.056 Δ	6	2.471	2.595	
0.100 Δ	1	4.412	4.633	
0.075 Δ	6	3.309	3.475	
0.200 Δ	1	8.825	9.266	
0.150 Δ	3	6.619	6.950	
0.300 Δ	1	13.237	13.899	
0.225 Δ	3	9.928	10.424	
0.400 Δ	1	17.650	18.532	
0.300 Δ	2	13.237	13.899	
0.700 Δ	1	30.887	32.431	
0.525 Δ	2	23.165	24.324	
1.000 Δ	1	44.124	46.331	
0.750 Δ	2	33.093	34.748	
1.500 Δ	1	66.187	69.496	
1.125 Δ	2	49.640	52.122	
2.000 Δ	1	88.249	92.661	
1.500 Δ	2	66.187	69.496	0.25 Hz
2.500 Δ	1	110.311	115.000	
1.875 Δ	2	82.733	86.870	

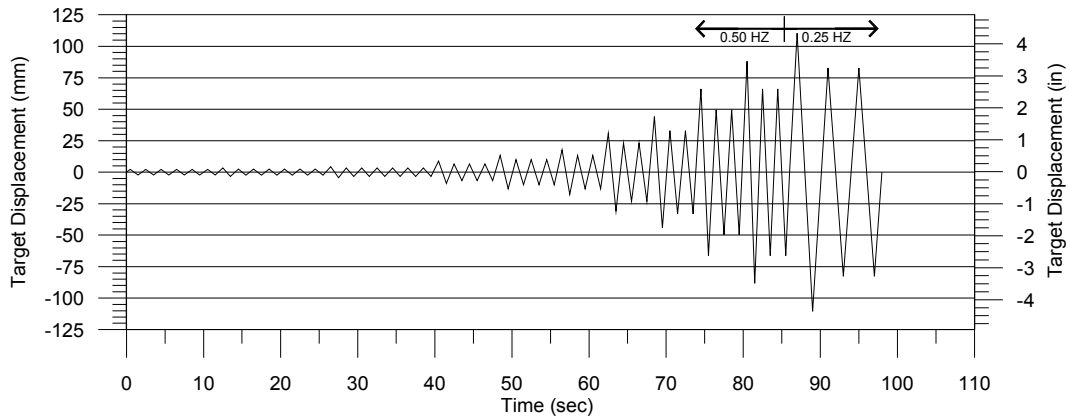

Figure D.7: CUREE reversed cyclic protocol for test 22A-C

Table D.8: CUREE reversed cyclic protocol for test 24A-C

Cycle Displacement	Number of Cycles	Target Displacement (mm)	Actuator Input (mm)	Frequency (Hz)
0.050 Δ	6	2.214	2.298	0.5 Hz
0.075 Δ	1	3.321	3.448	
0.056 Δ	6	2.480	2.574	
0.100 Δ	1	4.428	4.597	
0.075 Δ	6	3.321	3.448	
0.200 Δ	1	8.855	9.194	
0.150 Δ	3	6.642	6.895	
0.300 Δ	1	13.283	13.790	
0.225 Δ	3	9.962	10.343	
0.400 Δ	1	17.711	18.387	
0.300 Δ	2	13.283	13.790	
0.700 Δ	1	30.994	32.177	
0.525 Δ	2	23.245	24.133	
1.000 Δ	1	44.277	45.968	
0.750 Δ	2	33.208	34.476	
1.500 Δ	1	66.416	68.952	
1.125 Δ	2	49.812	51.714	
2.000 Δ	1	88.554	91.936	
1.500 Δ	2	66.416	68.952	0.25 Hz
2.500 Δ	1	110.693	114.920	
1.875 Δ	2	83.020	86.190	

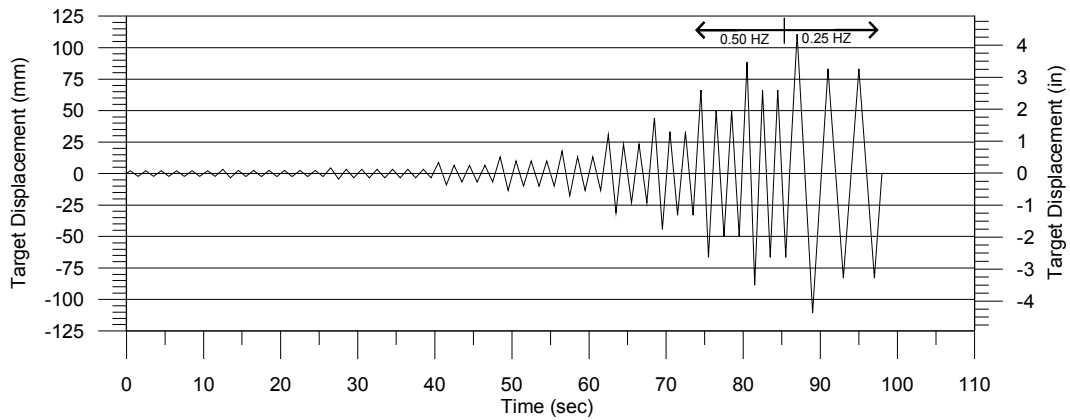

Figure D.8: CUREE reversed cyclic protocol for test 24A-C

Table D.9: CUREE reversed cyclic protocol for test 24B-C

Cycle Displacement	Number of Cycles	Target Displacement (mm)	Actuator Input (mm)	Frequency (Hz)
0.050 Δ	6	3.715	3.735	0.5 Hz
0.075 Δ	1	5.573	5.603	
0.056 Δ	6	4.161	4.183	
0.100 Δ	1	7.431	7.470	
0.075 Δ	6	5.573	5.603	
0.200 Δ	1	14.862	14.940	
0.150 Δ	3	11.146	11.205	
0.300 Δ	1	22.293	22.410	
0.225 Δ	3	16.719	16.808	
0.400 Δ	1	29.723	29.880	
0.300 Δ	2	22.293	22.410	
0.700 Δ	1	52.016	52.290	
0.525 Δ	2	39.012	39.218	
1.000 Δ	1	74.309	74.700	
0.750 Δ	2	55.732	56.025	
1.500 Δ	1	111.463	112.050	
1.125 Δ	2	83.597	84.038	

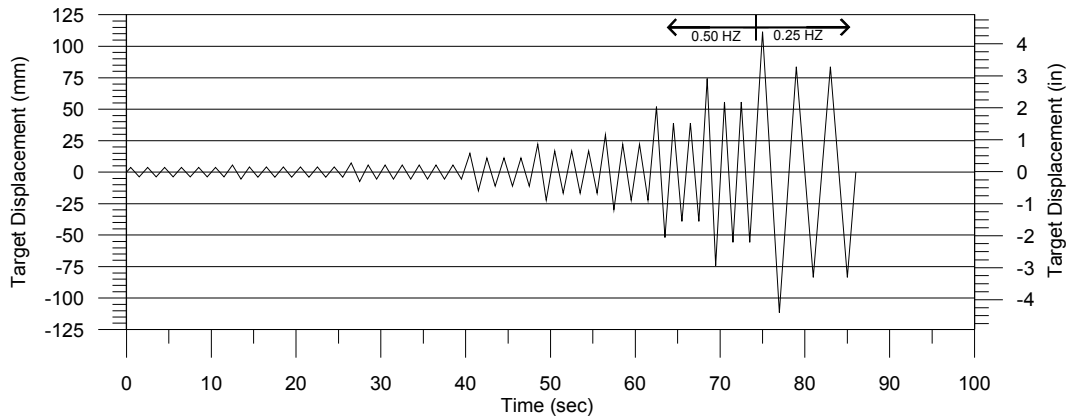

Figure D.9: CUREE reversed cyclic protocol for test 24B-C

Table D.10: CUREE reversed cyclic protocol for test 24C-C

Cycle Displacement	Number of Cycles	Target Displacement (mm)	Actuator Input (mm)	Frequency (Hz)
0.050 Δ	6	4.230	4.301	0.5 Hz
0.075 Δ	1	6.345	6.452	
0.056 Δ	6	4.738	4.817	
0.100 Δ	1	8.460	8.603	
0.075 Δ	6	6.345	6.452	
0.200 Δ	1	16.920	17.205	
0.150 Δ	3	12.690	12.904	
0.300 Δ	1	25.380	25.808	
0.225 Δ	3	19.035	19.356	
0.400 Δ	1	33.840	34.410	
0.300 Δ	2	25.380	25.808	
0.700 Δ	1	59.220	60.218	
0.525 Δ	2	44.415	45.164	
1.000 Δ	1	84.600	86.026	
0.750 Δ	2	63.450	64.519	0.25 Hz
1.500 Δ	1	118.011	120.000	
1.125 Δ	2	95.175	96.779	

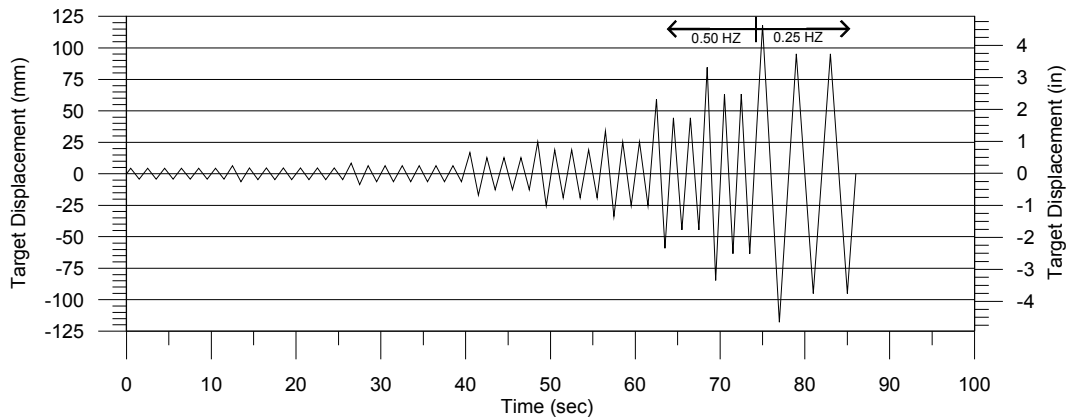

Figure D.10: CUREE reversed cyclic protocol for test 24C-C

Appendix E

Test Data Sheets and Observations

Cold Formed Steel Strap Braced Walls McGill University, Montreal												
TEST:		13 A-M										
RESEARCHER:		Gilles Comeau										
ASSISTANTS:		Kostadin Velchev, Nisreen Balh										
DATE:		9-Jul-07										
TIME:		11:00AM										
DIMENSIONS OF WALL:		8 FT X 8 FT X 3/8 IN.										
INITIAL STRAP SURVEY:		<table border="1" style="font-size: small;"> <tr><td>Front</td><td>Right</td><td>Left</td></tr> <tr><td>Back</td><td>Tight</td><td>Tight</td></tr> <tr><td></td><td>Tight</td><td>Tight</td></tr> </table>		Front	Right	Left	Back	Tight	Tight		Tight	Tight
Front	Right	Left										
Back	Tight	Tight										
	Tight	Tight										
STRAP FASTENER CONFIGURATION: MFR: McGill												
STRAP SIZE:												
<input checked="" type="checkbox"/>	2.5" 0.043" (1.09mm) 33 ksi (230 MPa)											
<input type="checkbox"/>	2.75" 0.054" (1.37mm) 50 ksi (340 MPa)											
<input type="checkbox"/>	4" 0.068" (1.73mm) 50 ksi (340 MPa)											
<input type="checkbox"/>	5" 0.043" (1.09) 33 ksi (230 MPa)											
<input type="checkbox"/>	Reduced section strap -- fuse = 2.5" wide x 30" long -- ends = 3.75" wide 0.043" (1.09mm) 33 ksi (230 MPa)											
<input type="checkbox"/>	Reduced section strap -- fuse = 2.75" wide x 30" long -- ends = 4.25" wide 0.054" (1.37mm) 50 ksi (340 MPa)											
<input type="checkbox"/>	Reduced section strap -- fuse = 4" wide x 30" long -- ends = 6" wide 0.068" (1.73mm) 50 ksi (340 MPa)											
<input type="checkbox"/>	Reduced section strap -- fuse = 2.5" wide x 60" long -- ends = 3.75" wide 0.043" (1.09mm) 33 ksi (230 MPa)											
<input type="checkbox"/>	Reduced section strap -- fuse = 4" wide x 60" long -- ends = 6" wide 0.068" (1.73mm) 50 ksi (340 MPa)											
INTERIOR STUDS:												
<input checked="" type="checkbox"/>	3-5/8"Wx1-5/8"Fx1/2"Lip 0.043" (1.09mm) 33ksi (230 Mpa)		STUD SPACING: <input checked="" type="checkbox"/> 16" O.C.									
<input type="checkbox"/>	6"Wx1-5/8"Fx1/2"Lip 0.043" (1.09mm) 33ksi (230 Mpa)		Other :									
BACK-TO-BACK CHORD STUDS:												
<input checked="" type="checkbox"/>	3-5/8"Wx1-5/8"Fx1/2"Lip 0.043" (1.09mm) 33ksi (230 Mpa)											
<input type="checkbox"/>	6"Wx1-5/8"Fx1/2"Lip 0.054" (1.37mm) 50ksi (345 Mpa)											
<input type="checkbox"/>	6"Wx1-5/8"Fx1/2"Lip 0.068" (1.73mm) 50ksi (345 Mpa)											
CONNECTIONS:												
<input checked="" type="checkbox"/>	No.10 gauge 0.75" self-drilling wafer head (mod. Truss) Phillips drive											
<input checked="" type="checkbox"/>	Framing: No.8 gauge 0.5" self-drilling wafer head (mod. Truss) Phillips drive											
<input checked="" type="checkbox"/>	Hold downs: No.14 gauge 0.1" self-drilling Hex washer head											
<input type="checkbox"/>	Back-to-Back											
<input checked="" type="checkbox"/>	Chord Studs: No.10 gauge 0.75" self-drilling Hex washer head											
<input checked="" type="checkbox"/>	Anchor Rods: 7/8" A193 Rod											
<input type="checkbox"/>	1" A193 Rod											
<input checked="" type="checkbox"/>	Loading Beam: A325 3/4" bolts											
<input checked="" type="checkbox"/>	Base: A325 3/4" bolts											
<input type="checkbox"/>	10 bolts	<input checked="" type="checkbox"/>	2 Anchor Rods <input checked="" type="checkbox"/>									
<input type="checkbox"/>	6 bolts	<input checked="" type="checkbox"/>	2 Anchor Rods <input checked="" type="checkbox"/>									
TRACK:												
<input type="checkbox"/>	Regular	<input type="checkbox"/>	6" web									
<input checked="" type="checkbox"/>	Extended	<input checked="" type="checkbox"/>	3 5/8" web									
<input type="checkbox"/>	Reinforced	<input type="checkbox"/>	1-1/4" flange									
<input checked="" type="checkbox"/>		<input checked="" type="checkbox"/>	0.043" (1.09mm) 33ksi (230 Mpa)									
<input type="checkbox"/>		<input type="checkbox"/>	0.054" (1.37mm) 50ksi (345 Mpa)									
<input type="checkbox"/>		<input type="checkbox"/>	0.068" (1.73mm) 50ksi (345 Mpa)									
HOLD DOWNS:												
<input checked="" type="checkbox"/>	S/HD10S Simpson		inside outside raised									
<input type="checkbox"/>	Fabricated U-shape		<input checked="" type="checkbox"/>									
<input type="checkbox"/>	6" x 6" 0.054" (1.37mm) 50 ksi (340 MPa) Gusset Plate w/ S/HD15SS Simpson											
<input type="checkbox"/>	7" x 9" 0.054" (1.37mm) 50 ksi (340 MPa) Gusset Plate w/ S/HD15SS Simpson											
<input type="checkbox"/>	8" x 8" 0.068" (1.73mm) 50 ksi (340 MPa) Gusset Plate w/ S/HD15SS Simpson											
<input type="checkbox"/>	8.5" x10" 0.068" (1.73mm) 50 ksi (340 MPa) Gusset Plate w/ S/HD15SS Simpson											
<input type="checkbox"/>	10" x10" 0.054" (1.37mm) 50 ksi (340 MPa) Gusset Plate w/ S/HD15SS Simpson											
TEST PROTOCOL AND DESCRIPTION:												
<input checked="" type="checkbox"/>	Monotonic (Rate of Loading 2.5 mm/min)											
<input type="checkbox"/>	Cyclic (CUREE cyclic protocol)											
DATA MEASUREMENTS:												
<input checked="" type="checkbox"/>	Actuator LVDT		<input checked="" type="checkbox"/> North Uplift									
<input checked="" type="checkbox"/>	North Slip		<input checked="" type="checkbox"/> South Uplift									
<input checked="" type="checkbox"/>	South Slip		<input checked="" type="checkbox"/> Top of Wall									
			TOTAL: <input type="text" value="6"/>									
STRAP WIDTH BEFORE TEST:												
	Front Right	Front Left, mm	Back Right, mm									
	<input type="text" value="65.98"/>	<input type="text" value="62.96"/>	<input type="text" value="64.07"/>									
	<input type="text" value="66.01"/>	<input type="text" value="64.08"/>	<input type="text" value="63.90"/>									
	<input type="text" value="64.75"/>	<input type="text" value="64.43"/>	<input type="text" value="63.02"/>									
	AVG <input type="text" value="65.58"/> mm	AVG <input type="text" value="63.82"/> mm	AVG <input type="text" value="63.66"/> mm									
			Back Left, mm									
			<input type="text" value="63.63"/>									
			<input type="text" value="64.29"/>									
			<input type="text" value="64.26"/>									
			AVG <input type="text" value="64.06"/> mm									
DATA ACQ. RECORD RATE: <input type="text" value="1 scan/sec"/> MONITOR RATE: <input type="text" value="10 scan/sec"/>												
COMMENTS:												
-Shear anchors torqued for 10 s with impact wrench												
-Hold down anchors 1/2 turn from finger tight (load cells used on both hold-downs)												
-Double chord studs used screwed back to back												
-Square plate washers (2.5"x2.5") used in all top track connections												
-Regular washers used in all bottom track connections												

Figure E.1: Data sheet for test 13A-M



Color Formed Steel Frame Strap Braced Shear Wall Testing

Test 13A-M (Pull)

↳ Notes in Pen

↳ Straps loose @ start of test

Test name: 13A-M 2.1 - Push

Date tested: 9 July 07

Wall Size: 8x9

Strap Size: 2.5"

Extended track: yes no

Holddown: Inside Outside

Test mode: Cyclic Monotonic

Front side notes:

Handwritten notes area for the front side, consisting of several horizontal lines.

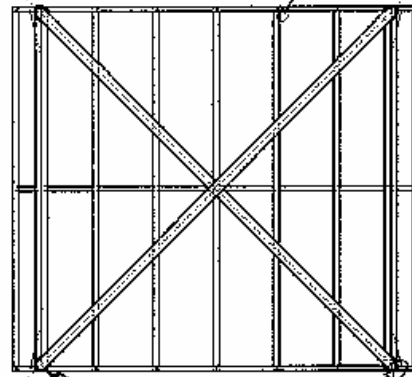

N

Front

S

S

Back

N

Back side notes:

Handwritten notes area for the back side, consisting of several horizontal lines.

Pull Test - track cracked @ weld, excessive uplift reading (A=160mm)

General notes:

Handwritten general notes: (W.A = 125mm, testing well. Brace fully yielded into strain hardening zone. some twisting of bottom track @, also some lifting at uplift anchor. visible distortion of chord studs from wall rotation.

Figure E.2: Observations for test 13A-M

Cold Formed Steel Strap Braced Walls McGill University, Montreal																																												
TEST:		15 A-M																																										
RESEARCHER:	Gilles Comeau	ASSISTANTS:	Kostadin Velchev, Nisreen Balh																																									
DATE:	9-Jul-07	TIME:	4:00PM																																									
DIMENSIONS OF WALL:	8 FT X 8 FT X 3 5/8 IN.	INITIAL STRAP SURVEY:	<table border="1" style="font-size: small;"> <tr><td>Front</td><td>Right</td><td>Left</td></tr> <tr><td>Back</td><td>Tight</td><td>Tight</td></tr> <tr><td></td><td>Tight</td><td>Loose</td></tr> </table>	Front	Right	Left	Back	Tight	Tight		Tight	Loose																																
Front	Right	Left																																										
Back	Tight	Tight																																										
	Tight	Loose																																										
STRAP FASTENER CONFIGURATION: MFR: McGill																																												
STRAP SIZE:	<table border="1" style="font-size: x-small;"> <tr><td><input checked="" type="checkbox"/></td><td>2.5" 0.043" (1.09mm) 33 ksi (230 MPa)</td></tr> <tr><td><input type="checkbox"/></td><td>2.75" 0.054" (1.37mm) 50 ksi (340 MPa)</td></tr> <tr><td><input type="checkbox"/></td><td>4" 0.068" (1.73mm) 50 ksi (340 MPa)</td></tr> <tr><td><input type="checkbox"/></td><td>5" 0.043" (1.09) 33 ksi (230 MPa)</td></tr> <tr><td><input type="checkbox"/></td><td>Reduced section strap -- fuse = 2.5" wide x 30" long -- ends = 3.75" wide 0.043" (1.09mm) 33 ksi (230 MPa)</td></tr> <tr><td><input type="checkbox"/></td><td>Reduced section strap -- fuse = 2.75" wide x 30" long -- ends = 4.25" wide 0.054" (1.37mm) 50 ksi (340 MPa)</td></tr> <tr><td><input type="checkbox"/></td><td>Reduced section strap -- fuse = 4" wide x 30" long -- ends = 6" wide 0.068" (1.73mm) 50 ksi (340 MPa)</td></tr> <tr><td><input type="checkbox"/></td><td>Reduced section strap -- fuse = 2.5" wide x 60" long -- ends = 3.75" wide 0.043" (1.09mm) 33 ksi (230 MPa)</td></tr> <tr><td><input type="checkbox"/></td><td>Reduced section strap -- fuse = 4" wide x 60" long -- ends = 6" wide 0.068" (1.73mm) 50 ksi (340 MPa)</td></tr> </table>			<input checked="" type="checkbox"/>	2.5" 0.043" (1.09mm) 33 ksi (230 MPa)	<input type="checkbox"/>	2.75" 0.054" (1.37mm) 50 ksi (340 MPa)	<input type="checkbox"/>	4" 0.068" (1.73mm) 50 ksi (340 MPa)	<input type="checkbox"/>	5" 0.043" (1.09) 33 ksi (230 MPa)	<input type="checkbox"/>	Reduced section strap -- fuse = 2.5" wide x 30" long -- ends = 3.75" wide 0.043" (1.09mm) 33 ksi (230 MPa)	<input type="checkbox"/>	Reduced section strap -- fuse = 2.75" wide x 30" long -- ends = 4.25" wide 0.054" (1.37mm) 50 ksi (340 MPa)	<input type="checkbox"/>	Reduced section strap -- fuse = 4" wide x 30" long -- ends = 6" wide 0.068" (1.73mm) 50 ksi (340 MPa)	<input type="checkbox"/>	Reduced section strap -- fuse = 2.5" wide x 60" long -- ends = 3.75" wide 0.043" (1.09mm) 33 ksi (230 MPa)	<input type="checkbox"/>	Reduced section strap -- fuse = 4" wide x 60" long -- ends = 6" wide 0.068" (1.73mm) 50 ksi (340 MPa)																							
<input checked="" type="checkbox"/>	2.5" 0.043" (1.09mm) 33 ksi (230 MPa)																																											
<input type="checkbox"/>	2.75" 0.054" (1.37mm) 50 ksi (340 MPa)																																											
<input type="checkbox"/>	4" 0.068" (1.73mm) 50 ksi (340 MPa)																																											
<input type="checkbox"/>	5" 0.043" (1.09) 33 ksi (230 MPa)																																											
<input type="checkbox"/>	Reduced section strap -- fuse = 2.5" wide x 30" long -- ends = 3.75" wide 0.043" (1.09mm) 33 ksi (230 MPa)																																											
<input type="checkbox"/>	Reduced section strap -- fuse = 2.75" wide x 30" long -- ends = 4.25" wide 0.054" (1.37mm) 50 ksi (340 MPa)																																											
<input type="checkbox"/>	Reduced section strap -- fuse = 4" wide x 30" long -- ends = 6" wide 0.068" (1.73mm) 50 ksi (340 MPa)																																											
<input type="checkbox"/>	Reduced section strap -- fuse = 2.5" wide x 60" long -- ends = 3.75" wide 0.043" (1.09mm) 33 ksi (230 MPa)																																											
<input type="checkbox"/>	Reduced section strap -- fuse = 4" wide x 60" long -- ends = 6" wide 0.068" (1.73mm) 50 ksi (340 MPa)																																											
INTERIOR STUDS:	<table border="1" style="font-size: x-small;"> <tr><td><input checked="" type="checkbox"/></td><td>3-5/8"Wx1-5/8"Fx1/2"Lip 0.043" (1.09mm) 33ksi (230 Mpa)</td></tr> <tr><td><input type="checkbox"/></td><td>6"Wx1-5/8"Fx1/2"Lip 0.043" (1.09mm) 33ksi (230 Mpa)</td></tr> </table>	<input checked="" type="checkbox"/>	3-5/8"Wx1-5/8"Fx1/2"Lip 0.043" (1.09mm) 33ksi (230 Mpa)	<input type="checkbox"/>	6"Wx1-5/8"Fx1/2"Lip 0.043" (1.09mm) 33ksi (230 Mpa)	STUD SPACING:	<table border="1" style="font-size: x-small;"> <tr><td><input checked="" type="checkbox"/></td><td>16" O.C.</td></tr> <tr><td><input type="checkbox"/></td><td>Other :</td></tr> </table>	<input checked="" type="checkbox"/>	16" O.C.	<input type="checkbox"/>	Other :																																	
<input checked="" type="checkbox"/>	3-5/8"Wx1-5/8"Fx1/2"Lip 0.043" (1.09mm) 33ksi (230 Mpa)																																											
<input type="checkbox"/>	6"Wx1-5/8"Fx1/2"Lip 0.043" (1.09mm) 33ksi (230 Mpa)																																											
<input checked="" type="checkbox"/>	16" O.C.																																											
<input type="checkbox"/>	Other :																																											
BACK-TO-BACK CHORD STUDS:	<table border="1" style="font-size: x-small;"> <tr><td><input checked="" type="checkbox"/></td><td>3-5/8"Wx1-5/8"Fx1/2"Lip 0.043" (1.09mm) 33ksi (230 Mpa)</td></tr> <tr><td><input type="checkbox"/></td><td>6"Wx1-5/8"Fx1/2"Lip 0.054" (1.37mm) 50ksi (345 Mpa)</td></tr> <tr><td><input type="checkbox"/></td><td>6"Wx1-5/8"Fx1/2"Lip 0.068" (1.73mm) 50ksi (345 Mpa)</td></tr> </table>			<input checked="" type="checkbox"/>	3-5/8"Wx1-5/8"Fx1/2"Lip 0.043" (1.09mm) 33ksi (230 Mpa)	<input type="checkbox"/>	6"Wx1-5/8"Fx1/2"Lip 0.054" (1.37mm) 50ksi (345 Mpa)	<input type="checkbox"/>	6"Wx1-5/8"Fx1/2"Lip 0.068" (1.73mm) 50ksi (345 Mpa)																																			
<input checked="" type="checkbox"/>	3-5/8"Wx1-5/8"Fx1/2"Lip 0.043" (1.09mm) 33ksi (230 Mpa)																																											
<input type="checkbox"/>	6"Wx1-5/8"Fx1/2"Lip 0.054" (1.37mm) 50ksi (345 Mpa)																																											
<input type="checkbox"/>	6"Wx1-5/8"Fx1/2"Lip 0.068" (1.73mm) 50ksi (345 Mpa)																																											
CONNECTIONS:	<table border="1" style="font-size: x-small;"> <tr><td>Straps</td><td><input checked="" type="checkbox"/></td><td>No.10 gauge 0.75" self-drilling wafer head (mod. Truss) Phillips drive</td></tr> <tr><td>Framing:</td><td><input checked="" type="checkbox"/></td><td>No.8 gauge 0.5" self-drilling wafer head (mod. Truss) Phillips drive</td></tr> <tr><td>Hold downs:</td><td><input checked="" type="checkbox"/></td><td>No.14 gauge 0.1" self-drilling Hex washer head</td></tr> <tr><td>Back-to-Back Chord Studs:</td><td><input checked="" type="checkbox"/></td><td>No.10 gauge 0.75" self-drilling Hex washer head</td></tr> <tr><td>Anchor Rods:</td><td><input type="checkbox"/></td><td>7/8" A193 Rod</td></tr> <tr><td></td><td><input type="checkbox"/></td><td>1" A193 Rod</td></tr> <tr><td>Loading Beam:</td><td><input checked="" type="checkbox"/></td><td>A325 3/4" bolts</td></tr> <tr><td>Base:</td><td><input checked="" type="checkbox"/></td><td>A325 3/4" bolts</td></tr> </table>			Straps	<input checked="" type="checkbox"/>	No.10 gauge 0.75" self-drilling wafer head (mod. Truss) Phillips drive	Framing:	<input checked="" type="checkbox"/>	No.8 gauge 0.5" self-drilling wafer head (mod. Truss) Phillips drive	Hold downs:	<input checked="" type="checkbox"/>	No.14 gauge 0.1" self-drilling Hex washer head	Back-to-Back Chord Studs:	<input checked="" type="checkbox"/>	No.10 gauge 0.75" self-drilling Hex washer head	Anchor Rods:	<input type="checkbox"/>	7/8" A193 Rod		<input type="checkbox"/>	1" A193 Rod	Loading Beam:	<input checked="" type="checkbox"/>	A325 3/4" bolts	Base:	<input checked="" type="checkbox"/>	A325 3/4" bolts																	
Straps	<input checked="" type="checkbox"/>	No.10 gauge 0.75" self-drilling wafer head (mod. Truss) Phillips drive																																										
Framing:	<input checked="" type="checkbox"/>	No.8 gauge 0.5" self-drilling wafer head (mod. Truss) Phillips drive																																										
Hold downs:	<input checked="" type="checkbox"/>	No.14 gauge 0.1" self-drilling Hex washer head																																										
Back-to-Back Chord Studs:	<input checked="" type="checkbox"/>	No.10 gauge 0.75" self-drilling Hex washer head																																										
Anchor Rods:	<input type="checkbox"/>	7/8" A193 Rod																																										
	<input type="checkbox"/>	1" A193 Rod																																										
Loading Beam:	<input checked="" type="checkbox"/>	A325 3/4" bolts																																										
Base:	<input checked="" type="checkbox"/>	A325 3/4" bolts																																										
TRACK:	<table border="1" style="font-size: x-small;"> <tr><td><input checked="" type="checkbox"/></td><td>Regular</td><td><input type="checkbox"/></td><td>6" web</td></tr> <tr><td><input type="checkbox"/></td><td>Extended</td><td><input checked="" type="checkbox"/></td><td>3 5/8" web</td></tr> <tr><td><input type="checkbox"/></td><td>Reinforced</td><td><input type="checkbox"/></td><td>1-1/4" flange</td></tr> </table>	<input checked="" type="checkbox"/>	Regular	<input type="checkbox"/>	6" web	<input type="checkbox"/>	Extended	<input checked="" type="checkbox"/>	3 5/8" web	<input type="checkbox"/>	Reinforced	<input type="checkbox"/>	1-1/4" flange	<table border="1" style="font-size: x-small;"> <tr><td><input type="checkbox"/></td><td>10 bolts</td><td><input checked="" type="checkbox"/></td><td>2 Anchor Rods</td></tr> <tr><td><input type="checkbox"/></td><td>6 bolts</td><td><input checked="" type="checkbox"/></td><td>2 Anchor Rods</td></tr> </table>	<input type="checkbox"/>	10 bolts	<input checked="" type="checkbox"/>	2 Anchor Rods	<input type="checkbox"/>	6 bolts	<input checked="" type="checkbox"/>	2 Anchor Rods																						
<input checked="" type="checkbox"/>	Regular	<input type="checkbox"/>	6" web																																									
<input type="checkbox"/>	Extended	<input checked="" type="checkbox"/>	3 5/8" web																																									
<input type="checkbox"/>	Reinforced	<input type="checkbox"/>	1-1/4" flange																																									
<input type="checkbox"/>	10 bolts	<input checked="" type="checkbox"/>	2 Anchor Rods																																									
<input type="checkbox"/>	6 bolts	<input checked="" type="checkbox"/>	2 Anchor Rods																																									
HOLD DOWNS:	<table border="1" style="font-size: x-small;"> <tr><td><input checked="" type="checkbox"/></td><td>S/HD10S Simpson</td></tr> <tr><td><input type="checkbox"/></td><td>Fabricated U-shape</td></tr> <tr><td><input type="checkbox"/></td><td>6" x 6" 0.054" (1.37mm) 50 ksi (340 MPa) Gusset Plate w/ S/HD15SS Simpson</td></tr> <tr><td><input type="checkbox"/></td><td>7" x 9" 0.054" (1.37mm) 50 ksi (340 MPa) Gusset Plate w/ S/HD15SS Simpson</td></tr> <tr><td><input type="checkbox"/></td><td>8" x 8" 0.068" (1.73mm) 50 ksi (340 MPa) Gusset Plate w/ S/HD15SS Simpson</td></tr> <tr><td><input type="checkbox"/></td><td>8.5" x10" 0.068" (1.73mm) 50 ksi (340 MPa) Gusset Plate w/ S/HD15SS Simpson</td></tr> <tr><td><input type="checkbox"/></td><td>10" x10" 0.054" (1.37mm) 50 ksi (340 MPa) Gusset Plate w/ S/HD15SS Simpson</td></tr> </table>	<input checked="" type="checkbox"/>	S/HD10S Simpson	<input type="checkbox"/>	Fabricated U-shape	<input type="checkbox"/>	6" x 6" 0.054" (1.37mm) 50 ksi (340 MPa) Gusset Plate w/ S/HD15SS Simpson	<input type="checkbox"/>	7" x 9" 0.054" (1.37mm) 50 ksi (340 MPa) Gusset Plate w/ S/HD15SS Simpson	<input type="checkbox"/>	8" x 8" 0.068" (1.73mm) 50 ksi (340 MPa) Gusset Plate w/ S/HD15SS Simpson	<input type="checkbox"/>	8.5" x10" 0.068" (1.73mm) 50 ksi (340 MPa) Gusset Plate w/ S/HD15SS Simpson	<input type="checkbox"/>	10" x10" 0.054" (1.37mm) 50 ksi (340 MPa) Gusset Plate w/ S/HD15SS Simpson	<table border="1" style="font-size: x-small;"> <thead> <tr><th></th><th>inside</th><th>outside</th><th>raised</th></tr> </thead> <tbody> <tr><td><input checked="" type="checkbox"/></td><td><input checked="" type="checkbox"/></td><td><input type="checkbox"/></td><td><input type="checkbox"/></td></tr> <tr><td><input type="checkbox"/></td><td><input type="checkbox"/></td><td><input type="checkbox"/></td><td><input type="checkbox"/></td></tr> <tr><td><input type="checkbox"/></td><td><input type="checkbox"/></td><td><input type="checkbox"/></td><td><input type="checkbox"/></td></tr> <tr><td><input type="checkbox"/></td><td><input type="checkbox"/></td><td><input type="checkbox"/></td><td><input type="checkbox"/></td></tr> <tr><td><input type="checkbox"/></td><td><input type="checkbox"/></td><td><input type="checkbox"/></td><td><input type="checkbox"/></td></tr> <tr><td><input type="checkbox"/></td><td><input type="checkbox"/></td><td><input type="checkbox"/></td><td><input type="checkbox"/></td></tr> </tbody> </table>		inside	outside	raised	<input checked="" type="checkbox"/>	<input checked="" type="checkbox"/>	<input type="checkbox"/>	<input type="checkbox"/>	<input type="checkbox"/>	<input type="checkbox"/>	<input type="checkbox"/>	<input type="checkbox"/>	<input type="checkbox"/>	<input type="checkbox"/>	<input type="checkbox"/>	<input type="checkbox"/>	<input type="checkbox"/>	<input type="checkbox"/>	<input type="checkbox"/>	<input type="checkbox"/>	<input type="checkbox"/>	<input type="checkbox"/>	<input type="checkbox"/>	<input type="checkbox"/>	<input type="checkbox"/>	<input type="checkbox"/>	<input type="checkbox"/>	<input type="checkbox"/>
<input checked="" type="checkbox"/>	S/HD10S Simpson																																											
<input type="checkbox"/>	Fabricated U-shape																																											
<input type="checkbox"/>	6" x 6" 0.054" (1.37mm) 50 ksi (340 MPa) Gusset Plate w/ S/HD15SS Simpson																																											
<input type="checkbox"/>	7" x 9" 0.054" (1.37mm) 50 ksi (340 MPa) Gusset Plate w/ S/HD15SS Simpson																																											
<input type="checkbox"/>	8" x 8" 0.068" (1.73mm) 50 ksi (340 MPa) Gusset Plate w/ S/HD15SS Simpson																																											
<input type="checkbox"/>	8.5" x10" 0.068" (1.73mm) 50 ksi (340 MPa) Gusset Plate w/ S/HD15SS Simpson																																											
<input type="checkbox"/>	10" x10" 0.054" (1.37mm) 50 ksi (340 MPa) Gusset Plate w/ S/HD15SS Simpson																																											
	inside	outside	raised																																									
<input checked="" type="checkbox"/>	<input checked="" type="checkbox"/>	<input type="checkbox"/>	<input type="checkbox"/>																																									
<input type="checkbox"/>	<input type="checkbox"/>	<input type="checkbox"/>	<input type="checkbox"/>																																									
<input type="checkbox"/>	<input type="checkbox"/>	<input type="checkbox"/>	<input type="checkbox"/>																																									
<input type="checkbox"/>	<input type="checkbox"/>	<input type="checkbox"/>	<input type="checkbox"/>																																									
<input type="checkbox"/>	<input type="checkbox"/>	<input type="checkbox"/>	<input type="checkbox"/>																																									
<input type="checkbox"/>	<input type="checkbox"/>	<input type="checkbox"/>	<input type="checkbox"/>																																									
TEST PROTOCOL AND DESCRIPTION:	<table border="1" style="font-size: x-small;"> <tr><td><input checked="" type="checkbox"/></td><td>Monotonic (Rate of Loading 2.5 mm/min)</td></tr> <tr><td><input type="checkbox"/></td><td>Cyclic (CUREE cyclic protocol)</td></tr> </table>			<input checked="" type="checkbox"/>	Monotonic (Rate of Loading 2.5 mm/min)	<input type="checkbox"/>	Cyclic (CUREE cyclic protocol)																																					
<input checked="" type="checkbox"/>	Monotonic (Rate of Loading 2.5 mm/min)																																											
<input type="checkbox"/>	Cyclic (CUREE cyclic protocol)																																											
DATA MEASUREMENTS:	<table border="1" style="font-size: x-small;"> <tr><td><input checked="" type="checkbox"/></td><td>Actuator LVDT</td></tr> <tr><td><input checked="" type="checkbox"/></td><td>North Slip</td></tr> <tr><td><input checked="" type="checkbox"/></td><td>South Slip</td></tr> </table>	<input checked="" type="checkbox"/>	Actuator LVDT	<input checked="" type="checkbox"/>	North Slip	<input checked="" type="checkbox"/>	South Slip	<table border="1" style="font-size: x-small;"> <tr><td><input checked="" type="checkbox"/></td><td>North Uplift</td></tr> <tr><td><input checked="" type="checkbox"/></td><td>South Uplift</td></tr> <tr><td><input checked="" type="checkbox"/></td><td>Top of Wall</td></tr> </table>	<input checked="" type="checkbox"/>	North Uplift	<input checked="" type="checkbox"/>	South Uplift	<input checked="" type="checkbox"/>	Top of Wall	TOTAL: <input type="text" value="6"/>																													
<input checked="" type="checkbox"/>	Actuator LVDT																																											
<input checked="" type="checkbox"/>	North Slip																																											
<input checked="" type="checkbox"/>	South Slip																																											
<input checked="" type="checkbox"/>	North Uplift																																											
<input checked="" type="checkbox"/>	South Uplift																																											
<input checked="" type="checkbox"/>	Top of Wall																																											
STRAP WIDTH BEFORE TEST:	<table border="1" style="font-size: x-small;"> <thead> <tr><th></th><th>Front Right</th><th>Front Left, mm</th><th>Back Right, mm</th><th>Back Left, mm</th></tr> </thead> <tbody> <tr><td></td><td>63.16</td><td>63.98</td><td>63.11</td><td>63.96</td></tr> <tr><td></td><td>63.35</td><td>64.02</td><td>63.92</td><td>63.76</td></tr> <tr><td></td><td>63.89</td><td>63.11</td><td>63.98</td><td>63.31</td></tr> <tr><td>AVG</td><td>63.47 mm</td><td>63.70 mm</td><td>63.67 mm</td><td>63.68 mm</td></tr> </tbody> </table>				Front Right	Front Left, mm	Back Right, mm	Back Left, mm		63.16	63.98	63.11	63.96		63.35	64.02	63.92	63.76		63.89	63.11	63.98	63.31	AVG	63.47 mm	63.70 mm	63.67 mm	63.68 mm																
	Front Right	Front Left, mm	Back Right, mm	Back Left, mm																																								
	63.16	63.98	63.11	63.96																																								
	63.35	64.02	63.92	63.76																																								
	63.89	63.11	63.98	63.31																																								
AVG	63.47 mm	63.70 mm	63.67 mm	63.68 mm																																								
DATA ACQ. RECORD RATE:	1 scan/sec	MONITOR RATE:	10 scan/sec																																									
COMMENTS:	<ul style="list-style-type: none"> -Shear anchors torqued for 10 s with impact wrench -Hold down anchors 1/2 turn from finger tight (load cells used on both hold-downs) -Double chord studs used screwed back to back -Square plate washers (2.5"x2.5") used in all top track connections -Regular washers used in all bottom track connections 																																											

Figure E.3: Data sheet for test 15A-M

Cold Formed Steel Strap Braced Walls McGill University, Montreal																																						
TEST:		15 B-M																																				
RESEARCHER:	Gilles Comeau		ASSISTANTS:	Kostadin Velchev, Nisreen Balh																																		
DATE:	16-Jul-07		TIME:	9:00AM																																		
DIMENSIONS OF WALL:	4 FT X	8 FT X	3 5/8 IN.	INITIAL STRAP SURVEY:	<table border="1" style="font-size: small;"> <tr><td>Right</td><td>Loose</td><td>Left</td><td>Loose</td></tr> <tr><td>Front</td><td>Loose</td><td>Back</td><td>Loose</td></tr> </table>	Right	Loose	Left	Loose	Front	Loose	Back	Loose																									
Right	Loose	Left	Loose																																			
Front	Loose	Back	Loose																																			
STRAP FASTENER CONFIGURATION: MFR: McGill																																						
STRAP SIZE:	<table border="1" style="font-size: x-small;"> <tr><td><input checked="" type="checkbox"/></td><td>2.5" 0.043" (1.09mm) 33 ksi (230 MPa)</td></tr> <tr><td><input type="checkbox"/></td><td>2.75" 0.054" (1.37mm) 50 ksi (340 MPa)</td></tr> <tr><td><input type="checkbox"/></td><td>4" 0.068" (1.73mm) 50 ksi (340 MPa)</td></tr> <tr><td><input type="checkbox"/></td><td>5" 0.043" (1.09) 33 ksi (230 MPa)</td></tr> <tr><td><input type="checkbox"/></td><td>Reduced section strap -- fuse = 2.5" wide x 30" long -- ends = 3.75" wide 0.043" (1.09mm) 33 ksi (230 MPa)</td></tr> <tr><td><input type="checkbox"/></td><td>Reduced section strap -- fuse = 2.75" wide x 30" long -- ends = 4.25" wide 0.054" (1.37mm) 50 ksi (340 MPa)</td></tr> <tr><td><input type="checkbox"/></td><td>Reduced section strap -- fuse = 4" wide x 30" long -- ends = 6" wide 0.068" (1.73mm) 50 ksi (340 MPa)</td></tr> <tr><td><input type="checkbox"/></td><td>Reduced section strap -- fuse = 2.5" wide x 60" long -- ends = 3.75" wide 0.043" (1.09mm) 33 ksi (230 MPa)</td></tr> <tr><td><input type="checkbox"/></td><td>Reduced section strap -- fuse = 4" wide x 60" long -- ends = 6" wide 0.068" (1.73mm) 50 ksi (340 MPa)</td></tr> </table>			<input checked="" type="checkbox"/>	2.5" 0.043" (1.09mm) 33 ksi (230 MPa)	<input type="checkbox"/>	2.75" 0.054" (1.37mm) 50 ksi (340 MPa)	<input type="checkbox"/>	4" 0.068" (1.73mm) 50 ksi (340 MPa)	<input type="checkbox"/>	5" 0.043" (1.09) 33 ksi (230 MPa)	<input type="checkbox"/>	Reduced section strap -- fuse = 2.5" wide x 30" long -- ends = 3.75" wide 0.043" (1.09mm) 33 ksi (230 MPa)	<input type="checkbox"/>	Reduced section strap -- fuse = 2.75" wide x 30" long -- ends = 4.25" wide 0.054" (1.37mm) 50 ksi (340 MPa)	<input type="checkbox"/>	Reduced section strap -- fuse = 4" wide x 30" long -- ends = 6" wide 0.068" (1.73mm) 50 ksi (340 MPa)	<input type="checkbox"/>	Reduced section strap -- fuse = 2.5" wide x 60" long -- ends = 3.75" wide 0.043" (1.09mm) 33 ksi (230 MPa)	<input type="checkbox"/>	Reduced section strap -- fuse = 4" wide x 60" long -- ends = 6" wide 0.068" (1.73mm) 50 ksi (340 MPa)																	
<input checked="" type="checkbox"/>	2.5" 0.043" (1.09mm) 33 ksi (230 MPa)																																					
<input type="checkbox"/>	2.75" 0.054" (1.37mm) 50 ksi (340 MPa)																																					
<input type="checkbox"/>	4" 0.068" (1.73mm) 50 ksi (340 MPa)																																					
<input type="checkbox"/>	5" 0.043" (1.09) 33 ksi (230 MPa)																																					
<input type="checkbox"/>	Reduced section strap -- fuse = 2.5" wide x 30" long -- ends = 3.75" wide 0.043" (1.09mm) 33 ksi (230 MPa)																																					
<input type="checkbox"/>	Reduced section strap -- fuse = 2.75" wide x 30" long -- ends = 4.25" wide 0.054" (1.37mm) 50 ksi (340 MPa)																																					
<input type="checkbox"/>	Reduced section strap -- fuse = 4" wide x 30" long -- ends = 6" wide 0.068" (1.73mm) 50 ksi (340 MPa)																																					
<input type="checkbox"/>	Reduced section strap -- fuse = 2.5" wide x 60" long -- ends = 3.75" wide 0.043" (1.09mm) 33 ksi (230 MPa)																																					
<input type="checkbox"/>	Reduced section strap -- fuse = 4" wide x 60" long -- ends = 6" wide 0.068" (1.73mm) 50 ksi (340 MPa)																																					
INTERIOR STUDS:	<table border="1" style="font-size: x-small;"> <tr><td><input checked="" type="checkbox"/></td><td>3-5/8"Wx1-5/8"Fx1/2"Lip 0.043" (1.09mm) 33ksi (230 Mpa)</td></tr> <tr><td><input type="checkbox"/></td><td>6"Wx1-5/8"Fx1/2"Lip 0.043" (1.09mm) 33ksi (230 Mpa)</td></tr> </table>		<input checked="" type="checkbox"/>	3-5/8"Wx1-5/8"Fx1/2"Lip 0.043" (1.09mm) 33ksi (230 Mpa)	<input type="checkbox"/>	6"Wx1-5/8"Fx1/2"Lip 0.043" (1.09mm) 33ksi (230 Mpa)	STUD SPACING:	<table border="1" style="font-size: x-small;"> <tr><td><input checked="" type="checkbox"/></td><td>16" O.C.</td></tr> <tr><td><input type="checkbox"/></td><td>Other :</td></tr> </table>	<input checked="" type="checkbox"/>	16" O.C.	<input type="checkbox"/>	Other :																										
<input checked="" type="checkbox"/>	3-5/8"Wx1-5/8"Fx1/2"Lip 0.043" (1.09mm) 33ksi (230 Mpa)																																					
<input type="checkbox"/>	6"Wx1-5/8"Fx1/2"Lip 0.043" (1.09mm) 33ksi (230 Mpa)																																					
<input checked="" type="checkbox"/>	16" O.C.																																					
<input type="checkbox"/>	Other :																																					
BACK-TO-BACK CHORD STUDS:	<table border="1" style="font-size: x-small;"> <tr><td><input checked="" type="checkbox"/></td><td>3-5/8"Wx1-5/8"Fx1/2"Lip 0.043" (1.09mm) 33ksi (230 Mpa)</td></tr> <tr><td><input type="checkbox"/></td><td>6"Wx1-5/8"Fx1/2"Lip 0.054" (1.37mm) 50ksi (345 Mpa)</td></tr> <tr><td><input type="checkbox"/></td><td>6"Wx1-5/8"Fx1/2"Lip 0.068" (1.73mm) 50ksi (345 Mpa)</td></tr> </table>			<input checked="" type="checkbox"/>	3-5/8"Wx1-5/8"Fx1/2"Lip 0.043" (1.09mm) 33ksi (230 Mpa)	<input type="checkbox"/>	6"Wx1-5/8"Fx1/2"Lip 0.054" (1.37mm) 50ksi (345 Mpa)	<input type="checkbox"/>	6"Wx1-5/8"Fx1/2"Lip 0.068" (1.73mm) 50ksi (345 Mpa)																													
<input checked="" type="checkbox"/>	3-5/8"Wx1-5/8"Fx1/2"Lip 0.043" (1.09mm) 33ksi (230 Mpa)																																					
<input type="checkbox"/>	6"Wx1-5/8"Fx1/2"Lip 0.054" (1.37mm) 50ksi (345 Mpa)																																					
<input type="checkbox"/>	6"Wx1-5/8"Fx1/2"Lip 0.068" (1.73mm) 50ksi (345 Mpa)																																					
CONNECTIONS:	<table border="1" style="font-size: x-small;"> <tr><td>Straps</td><td><input checked="" type="checkbox"/></td><td>No.10 gauge 0.75" self-drilling wafer head (mod. Truss) Phillips drive</td></tr> <tr><td>Framing:</td><td><input checked="" type="checkbox"/></td><td>No.8 gauge 0.5" self-drilling wafer head (mod. Truss) Phillips drive</td></tr> <tr><td>Hold downs:</td><td><input checked="" type="checkbox"/></td><td>No.14 gauge 0.1" self-drilling Hex washer head</td></tr> <tr><td>Back-to-Back Chord Studs:</td><td><input checked="" type="checkbox"/></td><td>No.10 gauge 0.75" self-drilling Hex washer head</td></tr> <tr><td>Anchor Rods</td><td><input checked="" type="checkbox"/></td><td>7/8" A193 Rod</td></tr> <tr><td></td><td><input checked="" type="checkbox"/></td><td>1" A193 Rod</td></tr> <tr><td>Loading Beam:</td><td><input checked="" type="checkbox"/></td><td>A325 3/4" bolts</td></tr> <tr><td>Base</td><td><input checked="" type="checkbox"/></td><td>A325 3/4" bolts</td></tr> </table>			Straps	<input checked="" type="checkbox"/>	No.10 gauge 0.75" self-drilling wafer head (mod. Truss) Phillips drive	Framing:	<input checked="" type="checkbox"/>	No.8 gauge 0.5" self-drilling wafer head (mod. Truss) Phillips drive	Hold downs:	<input checked="" type="checkbox"/>	No.14 gauge 0.1" self-drilling Hex washer head	Back-to-Back Chord Studs:	<input checked="" type="checkbox"/>	No.10 gauge 0.75" self-drilling Hex washer head	Anchor Rods	<input checked="" type="checkbox"/>	7/8" A193 Rod		<input checked="" type="checkbox"/>	1" A193 Rod	Loading Beam:	<input checked="" type="checkbox"/>	A325 3/4" bolts	Base	<input checked="" type="checkbox"/>	A325 3/4" bolts											
Straps	<input checked="" type="checkbox"/>	No.10 gauge 0.75" self-drilling wafer head (mod. Truss) Phillips drive																																				
Framing:	<input checked="" type="checkbox"/>	No.8 gauge 0.5" self-drilling wafer head (mod. Truss) Phillips drive																																				
Hold downs:	<input checked="" type="checkbox"/>	No.14 gauge 0.1" self-drilling Hex washer head																																				
Back-to-Back Chord Studs:	<input checked="" type="checkbox"/>	No.10 gauge 0.75" self-drilling Hex washer head																																				
Anchor Rods	<input checked="" type="checkbox"/>	7/8" A193 Rod																																				
	<input checked="" type="checkbox"/>	1" A193 Rod																																				
Loading Beam:	<input checked="" type="checkbox"/>	A325 3/4" bolts																																				
Base	<input checked="" type="checkbox"/>	A325 3/4" bolts																																				
TRACK:	<table border="1" style="font-size: x-small;"> <tr><td><input checked="" type="checkbox"/></td><td>Regular</td><td><input type="checkbox"/></td><td>6" web</td><td><input type="checkbox"/></td><td>0.043" (1.09mm) 33ksi (230 Mpa)</td></tr> <tr><td><input type="checkbox"/></td><td>Extended</td><td><input checked="" type="checkbox"/></td><td>3 5/8" web</td><td><input checked="" type="checkbox"/></td><td>0.054" (1.37mm) 50ksi (345 Mpa)</td></tr> <tr><td><input type="checkbox"/></td><td>Reinforced</td><td><input type="checkbox"/></td><td>1-1/4" flange</td><td><input type="checkbox"/></td><td>0.068" (1.73mm) 50ksi (345 Mpa)</td></tr> </table>			<input checked="" type="checkbox"/>	Regular	<input type="checkbox"/>	6" web	<input type="checkbox"/>	0.043" (1.09mm) 33ksi (230 Mpa)	<input type="checkbox"/>	Extended	<input checked="" type="checkbox"/>	3 5/8" web	<input checked="" type="checkbox"/>	0.054" (1.37mm) 50ksi (345 Mpa)	<input type="checkbox"/>	Reinforced	<input type="checkbox"/>	1-1/4" flange	<input type="checkbox"/>	0.068" (1.73mm) 50ksi (345 Mpa)																	
<input checked="" type="checkbox"/>	Regular	<input type="checkbox"/>	6" web	<input type="checkbox"/>	0.043" (1.09mm) 33ksi (230 Mpa)																																	
<input type="checkbox"/>	Extended	<input checked="" type="checkbox"/>	3 5/8" web	<input checked="" type="checkbox"/>	0.054" (1.37mm) 50ksi (345 Mpa)																																	
<input type="checkbox"/>	Reinforced	<input type="checkbox"/>	1-1/4" flange	<input type="checkbox"/>	0.068" (1.73mm) 50ksi (345 Mpa)																																	
HOLD DOWNS:	<table border="1" style="font-size: x-small;"> <tr><td><input checked="" type="checkbox"/></td><td>S/HD10S Simpson</td><td>inside</td><td>outside</td><td>raised</td></tr> <tr><td><input type="checkbox"/></td><td>Fabricated U-shape</td><td><input type="checkbox"/></td><td><input type="checkbox"/></td><td><input type="checkbox"/></td></tr> <tr><td><input type="checkbox"/></td><td>6" x 6" 0.054" (1.37mm) 50 ksi (340 MPa) Gusset Plate w/ S/HD15SS Simpson</td><td><input type="checkbox"/></td><td><input type="checkbox"/></td><td><input type="checkbox"/></td></tr> <tr><td><input type="checkbox"/></td><td>7" x 9" 0.054" (1.37mm) 50 ksi (340 MPa) Gusset Plate w/ S/HD15SS Simpson</td><td><input type="checkbox"/></td><td><input type="checkbox"/></td><td><input type="checkbox"/></td></tr> <tr><td><input type="checkbox"/></td><td>8" x 8" 0.068" (1.73mm) 50 ksi (340 MPa) Gusset Plate w/ S/HD15SS Simpson</td><td><input type="checkbox"/></td><td><input type="checkbox"/></td><td><input type="checkbox"/></td></tr> <tr><td><input type="checkbox"/></td><td>8.5" x 10" 0.068" (1.73mm) 50 ksi (340 MPa) Gusset Plate w/ S/HD15SS Simpson</td><td><input type="checkbox"/></td><td><input type="checkbox"/></td><td><input type="checkbox"/></td></tr> <tr><td><input type="checkbox"/></td><td>10" x 10" 0.054" (1.37mm) 50 ksi (340 MPa) Gusset Plate w/ S/HD15SS Simpson</td><td><input type="checkbox"/></td><td><input type="checkbox"/></td><td><input type="checkbox"/></td></tr> </table>			<input checked="" type="checkbox"/>	S/HD10S Simpson	inside	outside	raised	<input type="checkbox"/>	Fabricated U-shape	<input type="checkbox"/>	<input type="checkbox"/>	<input type="checkbox"/>	<input type="checkbox"/>	6" x 6" 0.054" (1.37mm) 50 ksi (340 MPa) Gusset Plate w/ S/HD15SS Simpson	<input type="checkbox"/>	<input type="checkbox"/>	<input type="checkbox"/>	<input type="checkbox"/>	7" x 9" 0.054" (1.37mm) 50 ksi (340 MPa) Gusset Plate w/ S/HD15SS Simpson	<input type="checkbox"/>	<input type="checkbox"/>	<input type="checkbox"/>	<input type="checkbox"/>	8" x 8" 0.068" (1.73mm) 50 ksi (340 MPa) Gusset Plate w/ S/HD15SS Simpson	<input type="checkbox"/>	<input type="checkbox"/>	<input type="checkbox"/>	<input type="checkbox"/>	8.5" x 10" 0.068" (1.73mm) 50 ksi (340 MPa) Gusset Plate w/ S/HD15SS Simpson	<input type="checkbox"/>	<input type="checkbox"/>	<input type="checkbox"/>	<input type="checkbox"/>	10" x 10" 0.054" (1.37mm) 50 ksi (340 MPa) Gusset Plate w/ S/HD15SS Simpson	<input type="checkbox"/>	<input type="checkbox"/>	<input type="checkbox"/>
<input checked="" type="checkbox"/>	S/HD10S Simpson	inside	outside	raised																																		
<input type="checkbox"/>	Fabricated U-shape	<input type="checkbox"/>	<input type="checkbox"/>	<input type="checkbox"/>																																		
<input type="checkbox"/>	6" x 6" 0.054" (1.37mm) 50 ksi (340 MPa) Gusset Plate w/ S/HD15SS Simpson	<input type="checkbox"/>	<input type="checkbox"/>	<input type="checkbox"/>																																		
<input type="checkbox"/>	7" x 9" 0.054" (1.37mm) 50 ksi (340 MPa) Gusset Plate w/ S/HD15SS Simpson	<input type="checkbox"/>	<input type="checkbox"/>	<input type="checkbox"/>																																		
<input type="checkbox"/>	8" x 8" 0.068" (1.73mm) 50 ksi (340 MPa) Gusset Plate w/ S/HD15SS Simpson	<input type="checkbox"/>	<input type="checkbox"/>	<input type="checkbox"/>																																		
<input type="checkbox"/>	8.5" x 10" 0.068" (1.73mm) 50 ksi (340 MPa) Gusset Plate w/ S/HD15SS Simpson	<input type="checkbox"/>	<input type="checkbox"/>	<input type="checkbox"/>																																		
<input type="checkbox"/>	10" x 10" 0.054" (1.37mm) 50 ksi (340 MPa) Gusset Plate w/ S/HD15SS Simpson	<input type="checkbox"/>	<input type="checkbox"/>	<input type="checkbox"/>																																		
TEST PROTOCOL AND DESCRIPTION:	<table border="1" style="font-size: x-small;"> <tr><td><input checked="" type="checkbox"/></td><td>Monotonic (Rate of Loading 2.5 mm/min)</td></tr> <tr><td><input type="checkbox"/></td><td>Cyclic (CUREE cyclic protocol)</td></tr> </table>			<input checked="" type="checkbox"/>	Monotonic (Rate of Loading 2.5 mm/min)	<input type="checkbox"/>	Cyclic (CUREE cyclic protocol)																															
<input checked="" type="checkbox"/>	Monotonic (Rate of Loading 2.5 mm/min)																																					
<input type="checkbox"/>	Cyclic (CUREE cyclic protocol)																																					
DATA MEASUREMENTS:	<table border="1" style="font-size: x-small;"> <tr><td><input checked="" type="checkbox"/></td><td>Actuator LVDT</td><td><input checked="" type="checkbox"/></td><td>North Uplift</td></tr> <tr><td><input checked="" type="checkbox"/></td><td>North Slip</td><td><input checked="" type="checkbox"/></td><td>South Uplift</td></tr> <tr><td><input checked="" type="checkbox"/></td><td>South Slip</td><td><input checked="" type="checkbox"/></td><td>Top of Wall</td></tr> </table>			<input checked="" type="checkbox"/>	Actuator LVDT	<input checked="" type="checkbox"/>	North Uplift	<input checked="" type="checkbox"/>	North Slip	<input checked="" type="checkbox"/>	South Uplift	<input checked="" type="checkbox"/>	South Slip	<input checked="" type="checkbox"/>	Top of Wall																							
<input checked="" type="checkbox"/>	Actuator LVDT	<input checked="" type="checkbox"/>	North Uplift																																			
<input checked="" type="checkbox"/>	North Slip	<input checked="" type="checkbox"/>	South Uplift																																			
<input checked="" type="checkbox"/>	South Slip	<input checked="" type="checkbox"/>	Top of Wall																																			
			TOTAL: <input type="text" value="6"/>																																			
STRAP WIDTH BEFORE TEST:	<table border="1" style="font-size: x-small; width: 100%;"> <tr><td>Front Right</td><td>Front Left, mm</td><td>Back Right, mm</td><td>Back Left, mm</td></tr> <tr><td>63.63</td><td>63.60</td><td>63.48</td><td>63.70</td></tr> <tr><td>63.4</td><td>63.37</td><td>63.24</td><td>63.96</td></tr> <tr><td>63.46</td><td>63.36</td><td>63.23</td><td>63.96</td></tr> <tr><td>AVG</td><td>63.50 mm</td><td>AVG</td><td>63.32 mm</td></tr> <tr><td></td><td></td><td>AVG</td><td>63.87 mm</td></tr> </table>			Front Right	Front Left, mm	Back Right, mm	Back Left, mm	63.63	63.60	63.48	63.70	63.4	63.37	63.24	63.96	63.46	63.36	63.23	63.96	AVG	63.50 mm	AVG	63.32 mm			AVG	63.87 mm											
Front Right	Front Left, mm	Back Right, mm	Back Left, mm																																			
63.63	63.60	63.48	63.70																																			
63.4	63.37	63.24	63.96																																			
63.46	63.36	63.23	63.96																																			
AVG	63.50 mm	AVG	63.32 mm																																			
		AVG	63.87 mm																																			
DATA ACQ. RECORD RATE:	1 scan/sec		MONITOR RATE:	10 scan/sec																																		
COMMENTS:	<ul style="list-style-type: none"> -Shear anchors torqued for 10 s with impact wrench -Hold down anchors 1/2 turn from finger tight (load cells used on both hold-downs) -Double chord studs used screwed back to back -Square plate washers (2.5"x2.5") used in all top track connections -Regular washers used in all bottom track connections 																																					

Figure E.5: Data sheet for test 15B-M

Test name : 15B-M
 Date tested : _____
 Wall Size : 4' x 8'
 Strap Size : 2.5"
 Extended Track : yes no
 Holddown : Inside Outside
 Test mode : Cyclic Monotonic

15B-M2 (Run 1st)
 Front-side notes:
 - screws @ Each Stud (interior)
 - upl. Pf + Rotation @ bottom
 - 1st corner:
 * 5 straps yielding @ 19 kN lateral load.
 * 2nd upl. Pf reading never so high due to rotation
 - F LVDT support brackets

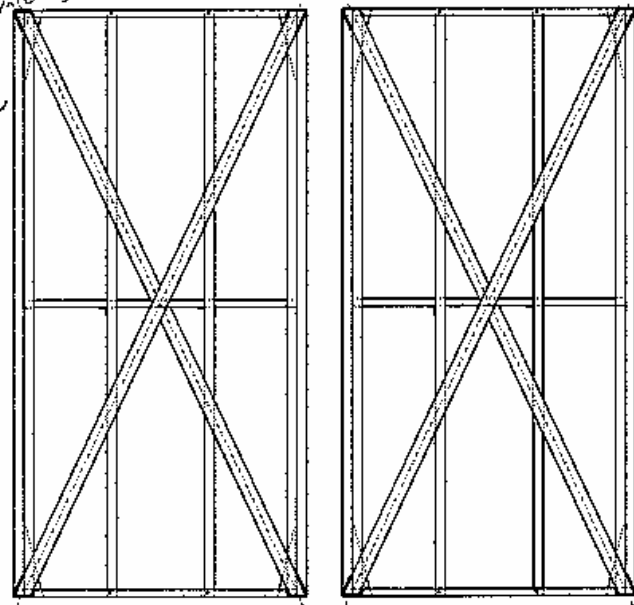

Back-side notes: 15B-M
 - wall working as plan
 - no strap/stud/brace failure recorded @ $\Delta = 2.10$
 - same lifting/rotation at bottom @ corner as in other tests.
 - test stopped @ $\Delta = 2.16$ because actuator ran out of stroke.

(N) Front (S) (S) Back (N)

Figure E.6: Observations for test 15B-M

Cold Formed Steel Strap Braced Walls																																
McGill University, Montreal																																
TEST:		17 A-M																														
RESEARCHER:		Gilles Comeau																														
ASSISTANTS:		Kostadin Velchev, Nisreen Balh																														
DATE:		11-Jul-07																														
TIME:		10:15AM																														
DIMENSIONS OF WALL:		8 FT X 8 FT X 6 IN.																														
INITIAL STRAP SURVEY:		<table style="width: 100%; border-collapse: collapse;"> <tr> <td style="width: 50%;"></td> <td style="width: 25%; text-align: center;">Right</td> <td style="width: 25%; text-align: center;">Left</td> </tr> <tr> <td style="text-align: center;">Front</td> <td style="text-align: center;">Tight</td> <td style="text-align: center;">Tight</td> </tr> <tr> <td style="text-align: center;">Back</td> <td style="text-align: center;">Loose</td> <td style="text-align: center;">Tight</td> </tr> </table>			Right	Left	Front	Tight	Tight	Back	Loose	Tight																				
	Right	Left																														
Front	Tight	Tight																														
Back	Loose	Tight																														
STRAP FASTENER CONFIGURATION:																																
MFR: McGill																																
STRAP SIZE:	<table style="width: 100%; border-collapse: collapse;"> <tr><td><input type="checkbox"/></td><td>2.5" 0.043" (1.09mm) 33 ksi (230 MPa)</td></tr> <tr><td><input checked="" type="checkbox"/></td><td>2.75" 0.054" (1.37mm) 50 ksi (340 MPa)</td></tr> <tr><td><input type="checkbox"/></td><td>4" 0.068" (1.73mm) 50 ksi (340 MPa)</td></tr> <tr><td><input type="checkbox"/></td><td>5" 0.043" (1.09) 33 ksi (230 MPa)</td></tr> <tr><td><input type="checkbox"/></td><td>Reduced section strap -- fuse = 2.5" wide x 30" long -- ends = 3.75" wide 0.043" (1.09mm) 33 ksi (230 MPa)</td></tr> <tr><td><input type="checkbox"/></td><td>Reduced section strap -- fuse = 2.75" wide x 30" long -- ends = 4.25" wide 0.054" (1.37mm) 50 ksi (340 MPa)</td></tr> <tr><td><input type="checkbox"/></td><td>Reduced section strap -- fuse = 4" wide x 30" long -- ends = 6" wide 0.068" (1.73mm) 50 ksi (340 MPa)</td></tr> <tr><td><input type="checkbox"/></td><td>Reduced section strap -- fuse = 2.5" wide x 60" long -- ends = 3.75" wide 0.043" (1.09mm) 33 ksi (230 MPa)</td></tr> <tr><td><input type="checkbox"/></td><td>Reduced section strap -- fuse = 4" wide x 60" long -- ends = 6" wide 0.068" (1.73mm) 50 ksi (340 MPa)</td></tr> </table>			<input type="checkbox"/>	2.5" 0.043" (1.09mm) 33 ksi (230 MPa)	<input checked="" type="checkbox"/>	2.75" 0.054" (1.37mm) 50 ksi (340 MPa)	<input type="checkbox"/>	4" 0.068" (1.73mm) 50 ksi (340 MPa)	<input type="checkbox"/>	5" 0.043" (1.09) 33 ksi (230 MPa)	<input type="checkbox"/>	Reduced section strap -- fuse = 2.5" wide x 30" long -- ends = 3.75" wide 0.043" (1.09mm) 33 ksi (230 MPa)	<input type="checkbox"/>	Reduced section strap -- fuse = 2.75" wide x 30" long -- ends = 4.25" wide 0.054" (1.37mm) 50 ksi (340 MPa)	<input type="checkbox"/>	Reduced section strap -- fuse = 4" wide x 30" long -- ends = 6" wide 0.068" (1.73mm) 50 ksi (340 MPa)	<input type="checkbox"/>	Reduced section strap -- fuse = 2.5" wide x 60" long -- ends = 3.75" wide 0.043" (1.09mm) 33 ksi (230 MPa)	<input type="checkbox"/>	Reduced section strap -- fuse = 4" wide x 60" long -- ends = 6" wide 0.068" (1.73mm) 50 ksi (340 MPa)											
<input type="checkbox"/>	2.5" 0.043" (1.09mm) 33 ksi (230 MPa)																															
<input checked="" type="checkbox"/>	2.75" 0.054" (1.37mm) 50 ksi (340 MPa)																															
<input type="checkbox"/>	4" 0.068" (1.73mm) 50 ksi (340 MPa)																															
<input type="checkbox"/>	5" 0.043" (1.09) 33 ksi (230 MPa)																															
<input type="checkbox"/>	Reduced section strap -- fuse = 2.5" wide x 30" long -- ends = 3.75" wide 0.043" (1.09mm) 33 ksi (230 MPa)																															
<input type="checkbox"/>	Reduced section strap -- fuse = 2.75" wide x 30" long -- ends = 4.25" wide 0.054" (1.37mm) 50 ksi (340 MPa)																															
<input type="checkbox"/>	Reduced section strap -- fuse = 4" wide x 30" long -- ends = 6" wide 0.068" (1.73mm) 50 ksi (340 MPa)																															
<input type="checkbox"/>	Reduced section strap -- fuse = 2.5" wide x 60" long -- ends = 3.75" wide 0.043" (1.09mm) 33 ksi (230 MPa)																															
<input type="checkbox"/>	Reduced section strap -- fuse = 4" wide x 60" long -- ends = 6" wide 0.068" (1.73mm) 50 ksi (340 MPa)																															
INTERIOR STUDS:	<table style="width: 100%; border-collapse: collapse;"> <tr><td><input type="checkbox"/></td><td>3-5/8"Wx1-5/8"Fx1/2"Lip 0.043" (1.09mm) 33ksi (230 Mpa)</td></tr> <tr><td><input checked="" type="checkbox"/></td><td>6"Wx1-5/8"Fx1/2"Lip 0.043" (1.09mm) 33ksi (230 Mpa)</td></tr> </table>		<input type="checkbox"/>	3-5/8"Wx1-5/8"Fx1/2"Lip 0.043" (1.09mm) 33ksi (230 Mpa)	<input checked="" type="checkbox"/>	6"Wx1-5/8"Fx1/2"Lip 0.043" (1.09mm) 33ksi (230 Mpa)	STUD SPACING:	<table style="width: 100%; border-collapse: collapse;"> <tr><td><input checked="" type="checkbox"/></td><td>16" O.C.</td></tr> <tr><td><input type="checkbox"/></td><td>Other: _____</td></tr> </table>	<input checked="" type="checkbox"/>	16" O.C.	<input type="checkbox"/>	Other: _____																				
<input type="checkbox"/>	3-5/8"Wx1-5/8"Fx1/2"Lip 0.043" (1.09mm) 33ksi (230 Mpa)																															
<input checked="" type="checkbox"/>	6"Wx1-5/8"Fx1/2"Lip 0.043" (1.09mm) 33ksi (230 Mpa)																															
<input checked="" type="checkbox"/>	16" O.C.																															
<input type="checkbox"/>	Other: _____																															
BACK-TO-BACK CHORD STUDS:	<table style="width: 100%; border-collapse: collapse;"> <tr><td><input type="checkbox"/></td><td>3-5/8"Wx1-5/8"Fx1/2"Lip 0.043" (1.09mm) 33ksi (230 Mpa)</td></tr> <tr><td><input checked="" type="checkbox"/></td><td>6"Wx1-5/8"Fx1/2"Lip 0.054" (1.37mm) 50ksi (345 Mpa)</td></tr> <tr><td><input type="checkbox"/></td><td>6"Wx1-5/8"Fx1/2"Lip 0.068" (1.73mm) 50ksi (345 Mpa)</td></tr> </table>			<input type="checkbox"/>	3-5/8"Wx1-5/8"Fx1/2"Lip 0.043" (1.09mm) 33ksi (230 Mpa)	<input checked="" type="checkbox"/>	6"Wx1-5/8"Fx1/2"Lip 0.054" (1.37mm) 50ksi (345 Mpa)	<input type="checkbox"/>	6"Wx1-5/8"Fx1/2"Lip 0.068" (1.73mm) 50ksi (345 Mpa)																							
<input type="checkbox"/>	3-5/8"Wx1-5/8"Fx1/2"Lip 0.043" (1.09mm) 33ksi (230 Mpa)																															
<input checked="" type="checkbox"/>	6"Wx1-5/8"Fx1/2"Lip 0.054" (1.37mm) 50ksi (345 Mpa)																															
<input type="checkbox"/>	6"Wx1-5/8"Fx1/2"Lip 0.068" (1.73mm) 50ksi (345 Mpa)																															
CONNECTIONS:	<table style="width: 100%; border-collapse: collapse;"> <tr><td><input checked="" type="checkbox"/></td><td>No.10 gauge 0.75" self-drilling wafer head (mod. Truss) Phillips drive</td></tr> <tr><td><input checked="" type="checkbox"/></td><td>No.8 gauge 0.5" self-drilling wafer head (mod. Truss) Phillips drive</td></tr> <tr><td><input checked="" type="checkbox"/></td><td>No.14 gauge 0.1" self-drilling Hex washer head</td></tr> <tr><td><input type="checkbox"/></td><td>Back-to-Back</td></tr> <tr><td><input checked="" type="checkbox"/></td><td>No.10 gauge 0.75" self-drilling Hex washer head</td></tr> <tr><td><input type="checkbox"/></td><td>Anchor Rods</td></tr> <tr><td><input type="checkbox"/></td><td>7/8" A193 Rod</td></tr> <tr><td><input checked="" type="checkbox"/></td><td>1" A193 Rod</td></tr> <tr><td><input checked="" type="checkbox"/></td><td>Loading Beam: A325 3/4" bolts</td></tr> <tr><td><input checked="" type="checkbox"/></td><td>Base: A325 3/4" bolts</td></tr> </table>			<input checked="" type="checkbox"/>	No.10 gauge 0.75" self-drilling wafer head (mod. Truss) Phillips drive	<input checked="" type="checkbox"/>	No.8 gauge 0.5" self-drilling wafer head (mod. Truss) Phillips drive	<input checked="" type="checkbox"/>	No.14 gauge 0.1" self-drilling Hex washer head	<input type="checkbox"/>	Back-to-Back	<input checked="" type="checkbox"/>	No.10 gauge 0.75" self-drilling Hex washer head	<input type="checkbox"/>	Anchor Rods	<input type="checkbox"/>	7/8" A193 Rod	<input checked="" type="checkbox"/>	1" A193 Rod	<input checked="" type="checkbox"/>	Loading Beam: A325 3/4" bolts	<input checked="" type="checkbox"/>	Base: A325 3/4" bolts									
<input checked="" type="checkbox"/>	No.10 gauge 0.75" self-drilling wafer head (mod. Truss) Phillips drive																															
<input checked="" type="checkbox"/>	No.8 gauge 0.5" self-drilling wafer head (mod. Truss) Phillips drive																															
<input checked="" type="checkbox"/>	No.14 gauge 0.1" self-drilling Hex washer head																															
<input type="checkbox"/>	Back-to-Back																															
<input checked="" type="checkbox"/>	No.10 gauge 0.75" self-drilling Hex washer head																															
<input type="checkbox"/>	Anchor Rods																															
<input type="checkbox"/>	7/8" A193 Rod																															
<input checked="" type="checkbox"/>	1" A193 Rod																															
<input checked="" type="checkbox"/>	Loading Beam: A325 3/4" bolts																															
<input checked="" type="checkbox"/>	Base: A325 3/4" bolts																															
TRACK:	<table style="width: 100%; border-collapse: collapse;"> <tr><td><input type="checkbox"/></td><td>Regular</td><td><input checked="" type="checkbox"/></td><td>6" web</td></tr> <tr><td><input checked="" type="checkbox"/></td><td>Extended</td><td><input type="checkbox"/></td><td>3 5/8" web</td></tr> <tr><td><input type="checkbox"/></td><td>Reinforced</td><td><input type="checkbox"/></td><td>1-1/4" flange</td></tr> </table>		<input type="checkbox"/>	Regular	<input checked="" type="checkbox"/>	6" web	<input checked="" type="checkbox"/>	Extended	<input type="checkbox"/>	3 5/8" web	<input type="checkbox"/>	Reinforced	<input type="checkbox"/>	1-1/4" flange	<table style="width: 100%; border-collapse: collapse;"> <tr><td><input type="checkbox"/></td><td>10 bolts</td><td><input checked="" type="checkbox"/></td><td>2 Anchor Rods</td></tr> <tr><td><input type="checkbox"/></td><td>6 bolts</td><td><input checked="" type="checkbox"/></td><td>2 Anchor Rods</td></tr> </table>	<input type="checkbox"/>	10 bolts	<input checked="" type="checkbox"/>	2 Anchor Rods	<input type="checkbox"/>	6 bolts	<input checked="" type="checkbox"/>	2 Anchor Rods									
<input type="checkbox"/>	Regular	<input checked="" type="checkbox"/>	6" web																													
<input checked="" type="checkbox"/>	Extended	<input type="checkbox"/>	3 5/8" web																													
<input type="checkbox"/>	Reinforced	<input type="checkbox"/>	1-1/4" flange																													
<input type="checkbox"/>	10 bolts	<input checked="" type="checkbox"/>	2 Anchor Rods																													
<input type="checkbox"/>	6 bolts	<input checked="" type="checkbox"/>	2 Anchor Rods																													
HOLD DOWNS:	<table style="width: 100%; border-collapse: collapse;"> <tr><td><input type="checkbox"/></td><td>S/HD10S Simpson</td></tr> <tr><td><input type="checkbox"/></td><td>Fabricated U-shape</td></tr> <tr><td><input checked="" type="checkbox"/></td><td>6" x 6" 0.054" (1.37mm) 50 ksi (340 MPa) Gusset Plate w/ S/HD15SS Simpson</td></tr> <tr><td><input type="checkbox"/></td><td>7" x 9" 0.054" (1.37mm) 50 ksi (340 MPa) Gusset Plate w/ S/HD15SS Simpson</td></tr> <tr><td><input type="checkbox"/></td><td>8" x 8" 0.068" (1.73mm) 50 ksi (340 MPa) Gusset Plate w/ S/HD15SS Simpson</td></tr> <tr><td><input type="checkbox"/></td><td>8.5" x10" 0.068" (1.73mm) 50 ksi (340 MPa) Gusset Plate w/ S/HD15SS Simpson</td></tr> <tr><td><input type="checkbox"/></td><td>10" x10" 0.054" (1.37mm) 50 ksi (340 MPa) Gusset Plate w/ S/HD15SS Simpson</td></tr> </table>			<input type="checkbox"/>	S/HD10S Simpson	<input type="checkbox"/>	Fabricated U-shape	<input checked="" type="checkbox"/>	6" x 6" 0.054" (1.37mm) 50 ksi (340 MPa) Gusset Plate w/ S/HD15SS Simpson	<input type="checkbox"/>	7" x 9" 0.054" (1.37mm) 50 ksi (340 MPa) Gusset Plate w/ S/HD15SS Simpson	<input type="checkbox"/>	8" x 8" 0.068" (1.73mm) 50 ksi (340 MPa) Gusset Plate w/ S/HD15SS Simpson	<input type="checkbox"/>	8.5" x10" 0.068" (1.73mm) 50 ksi (340 MPa) Gusset Plate w/ S/HD15SS Simpson	<input type="checkbox"/>	10" x10" 0.054" (1.37mm) 50 ksi (340 MPa) Gusset Plate w/ S/HD15SS Simpson															
<input type="checkbox"/>	S/HD10S Simpson																															
<input type="checkbox"/>	Fabricated U-shape																															
<input checked="" type="checkbox"/>	6" x 6" 0.054" (1.37mm) 50 ksi (340 MPa) Gusset Plate w/ S/HD15SS Simpson																															
<input type="checkbox"/>	7" x 9" 0.054" (1.37mm) 50 ksi (340 MPa) Gusset Plate w/ S/HD15SS Simpson																															
<input type="checkbox"/>	8" x 8" 0.068" (1.73mm) 50 ksi (340 MPa) Gusset Plate w/ S/HD15SS Simpson																															
<input type="checkbox"/>	8.5" x10" 0.068" (1.73mm) 50 ksi (340 MPa) Gusset Plate w/ S/HD15SS Simpson																															
<input type="checkbox"/>	10" x10" 0.054" (1.37mm) 50 ksi (340 MPa) Gusset Plate w/ S/HD15SS Simpson																															
TEST PROTOCOL AND DESCRIPTION:	<table style="width: 100%; border-collapse: collapse;"> <tr><td><input checked="" type="checkbox"/></td><td>Monotonic (Rate of Loading 2.5 mm/min)</td></tr> <tr><td><input type="checkbox"/></td><td>Cyclic (CUREE cyclic protocol)</td></tr> </table>			<input checked="" type="checkbox"/>	Monotonic (Rate of Loading 2.5 mm/min)	<input type="checkbox"/>	Cyclic (CUREE cyclic protocol)																									
<input checked="" type="checkbox"/>	Monotonic (Rate of Loading 2.5 mm/min)																															
<input type="checkbox"/>	Cyclic (CUREE cyclic protocol)																															
DATA MEASUREMENTS:	<table style="width: 100%; border-collapse: collapse;"> <tr><td><input checked="" type="checkbox"/></td><td>Actuator LVDT</td><td><input checked="" type="checkbox"/></td><td>North Uplift</td></tr> <tr><td><input checked="" type="checkbox"/></td><td>North Slip</td><td><input checked="" type="checkbox"/></td><td>South Uplift</td></tr> <tr><td><input checked="" type="checkbox"/></td><td>South Slip</td><td><input checked="" type="checkbox"/></td><td>Top of Wall</td></tr> </table>			<input checked="" type="checkbox"/>	Actuator LVDT	<input checked="" type="checkbox"/>	North Uplift	<input checked="" type="checkbox"/>	North Slip	<input checked="" type="checkbox"/>	South Uplift	<input checked="" type="checkbox"/>	South Slip	<input checked="" type="checkbox"/>	Top of Wall																	
<input checked="" type="checkbox"/>	Actuator LVDT	<input checked="" type="checkbox"/>	North Uplift																													
<input checked="" type="checkbox"/>	North Slip	<input checked="" type="checkbox"/>	South Uplift																													
<input checked="" type="checkbox"/>	South Slip	<input checked="" type="checkbox"/>	Top of Wall																													
			TOTAL: <input type="text" value="6"/>																													
STRAP WIDTH BEFORE TEST:	<table style="width: 100%; border-collapse: collapse;"> <tr> <td style="width: 25%; text-align: center;"> <table style="width: 100%; border-collapse: collapse;"> <tr><td style="text-align: center;">Front Right</td></tr> <tr><td style="text-align: center;">70.32</td></tr> <tr><td style="text-align: center;">70.06</td></tr> <tr><td style="text-align: center;">70.18</td></tr> <tr><td style="text-align: center;">AVG</td></tr> </table> </td> <td style="width: 25%; text-align: center;"> <table style="width: 100%; border-collapse: collapse;"> <tr><td style="text-align: center;">Front Left, mm</td></tr> <tr><td style="text-align: center;">70.35</td></tr> <tr><td style="text-align: center;">70.30</td></tr> <tr><td style="text-align: center;">70.37</td></tr> <tr><td style="text-align: center;">AVG</td></tr> </table> </td> <td style="width: 25%; text-align: center;"> <table style="width: 100%; border-collapse: collapse;"> <tr><td style="text-align: center;">Back Right, mm</td></tr> <tr><td style="text-align: center;">70.32</td></tr> <tr><td style="text-align: center;">69.96</td></tr> <tr><td style="text-align: center;">70.14</td></tr> <tr><td style="text-align: center;">AVG</td></tr> </table> </td> <td style="width: 25%; text-align: center;"> <table style="width: 100%; border-collapse: collapse;"> <tr><td style="text-align: center;">Back Left, mm</td></tr> <tr><td style="text-align: center;">70.17</td></tr> <tr><td style="text-align: center;">70.13</td></tr> <tr><td style="text-align: center;">70.39</td></tr> <tr><td style="text-align: center;">AVG</td></tr> </table> </td> </tr> <tr> <td style="text-align: center;">AVG</td> <td style="text-align: center;">70.19 mm</td> <td style="text-align: center;">70.34 mm</td> <td style="text-align: center;">70.14 mm</td> <td style="text-align: center;">70.23 mm</td> </tr> </table>			<table style="width: 100%; border-collapse: collapse;"> <tr><td style="text-align: center;">Front Right</td></tr> <tr><td style="text-align: center;">70.32</td></tr> <tr><td style="text-align: center;">70.06</td></tr> <tr><td style="text-align: center;">70.18</td></tr> <tr><td style="text-align: center;">AVG</td></tr> </table>	Front Right	70.32	70.06	70.18	AVG	<table style="width: 100%; border-collapse: collapse;"> <tr><td style="text-align: center;">Front Left, mm</td></tr> <tr><td style="text-align: center;">70.35</td></tr> <tr><td style="text-align: center;">70.30</td></tr> <tr><td style="text-align: center;">70.37</td></tr> <tr><td style="text-align: center;">AVG</td></tr> </table>	Front Left, mm	70.35	70.30	70.37	AVG	<table style="width: 100%; border-collapse: collapse;"> <tr><td style="text-align: center;">Back Right, mm</td></tr> <tr><td style="text-align: center;">70.32</td></tr> <tr><td style="text-align: center;">69.96</td></tr> <tr><td style="text-align: center;">70.14</td></tr> <tr><td style="text-align: center;">AVG</td></tr> </table>	Back Right, mm	70.32	69.96	70.14	AVG	<table style="width: 100%; border-collapse: collapse;"> <tr><td style="text-align: center;">Back Left, mm</td></tr> <tr><td style="text-align: center;">70.17</td></tr> <tr><td style="text-align: center;">70.13</td></tr> <tr><td style="text-align: center;">70.39</td></tr> <tr><td style="text-align: center;">AVG</td></tr> </table>	Back Left, mm	70.17	70.13	70.39	AVG	AVG	70.19 mm	70.34 mm	70.14 mm	70.23 mm
<table style="width: 100%; border-collapse: collapse;"> <tr><td style="text-align: center;">Front Right</td></tr> <tr><td style="text-align: center;">70.32</td></tr> <tr><td style="text-align: center;">70.06</td></tr> <tr><td style="text-align: center;">70.18</td></tr> <tr><td style="text-align: center;">AVG</td></tr> </table>	Front Right	70.32	70.06	70.18	AVG	<table style="width: 100%; border-collapse: collapse;"> <tr><td style="text-align: center;">Front Left, mm</td></tr> <tr><td style="text-align: center;">70.35</td></tr> <tr><td style="text-align: center;">70.30</td></tr> <tr><td style="text-align: center;">70.37</td></tr> <tr><td style="text-align: center;">AVG</td></tr> </table>	Front Left, mm	70.35	70.30	70.37	AVG	<table style="width: 100%; border-collapse: collapse;"> <tr><td style="text-align: center;">Back Right, mm</td></tr> <tr><td style="text-align: center;">70.32</td></tr> <tr><td style="text-align: center;">69.96</td></tr> <tr><td style="text-align: center;">70.14</td></tr> <tr><td style="text-align: center;">AVG</td></tr> </table>	Back Right, mm	70.32	69.96	70.14	AVG	<table style="width: 100%; border-collapse: collapse;"> <tr><td style="text-align: center;">Back Left, mm</td></tr> <tr><td style="text-align: center;">70.17</td></tr> <tr><td style="text-align: center;">70.13</td></tr> <tr><td style="text-align: center;">70.39</td></tr> <tr><td style="text-align: center;">AVG</td></tr> </table>	Back Left, mm	70.17	70.13	70.39	AVG									
Front Right																																
70.32																																
70.06																																
70.18																																
AVG																																
Front Left, mm																																
70.35																																
70.30																																
70.37																																
AVG																																
Back Right, mm																																
70.32																																
69.96																																
70.14																																
AVG																																
Back Left, mm																																
70.17																																
70.13																																
70.39																																
AVG																																
AVG	70.19 mm	70.34 mm	70.14 mm	70.23 mm																												
DATA ACQ. RECORD RATE:	1 scan/sec																															
MONITOR RATE:	10 scan/sec																															
COMMENTS:	<ul style="list-style-type: none"> -Shear anchors torqued for 10 s with impact wrench -Hold down anchors 1/2 turn from finger tight (load cells used on both hold-downs) -Double chord studs used screwed back to back -Square plate washers (2.5"x2.5") used in all top track connections -Regular washers used in all bottom track connections 																															

Figure E.7: Data sheet for test 17A-M

Test name : 17A-M
 Date tested : 11-7-06 - Rec7
 Wall Size : 8' x 9'
 Strap Size : 2.75"
 Extended Track : yes no
 Holddown : Inside Outside
 Test made : Cyclic Monotonic

 front side notes: _____

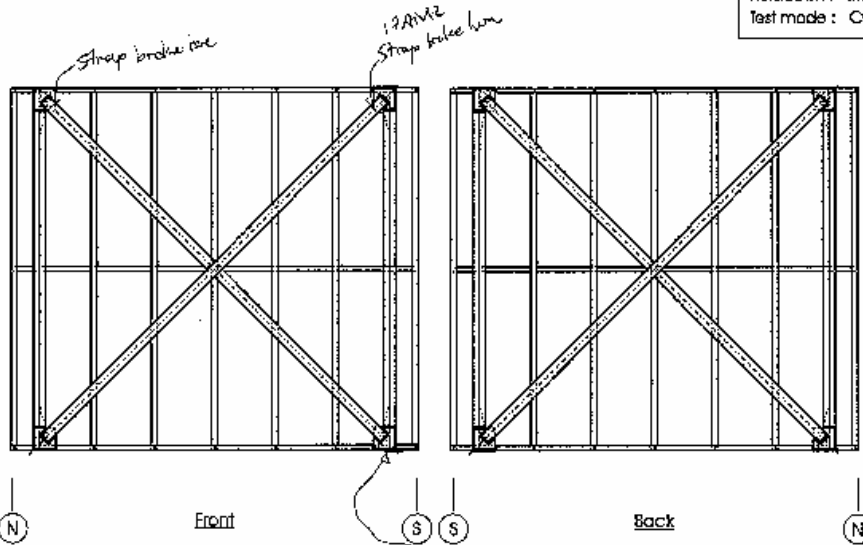
 Back side notes: _____

General notes: 1st Run 17A-M1 → Touch readily under ② anchor Rod → see pics.
 → Strap broke @ A=197mm
 → other strap held until 220mm
 2nd Run 17A-M2 front strap broke @ A=190mm

Figure E.8: Observations for test 17A-M

Cold Formed Steel Strap Braced Walls McGill University, Montreal																																						
TEST:		19 A-M																																				
RESEARCHER:	Gilles Comeau		ASSISTANTS:																																			
		Kostadin Velchev, Nisreen Balh																																				
DATE:	18-Jun-07		TIME:																																			
		9:00AM																																				
DIMENSIONS OF WALL:	8 FT X	8 FT X	6 IN.																																			
INITIAL STRAP SURVEY:	Front	Right	Left																																			
	Back	Tight	Tight																																			
		Loose	Tight																																			
STRAP FASTENER CONFIGURATION: MFR: McGill																																						
STRAP SIZE:	<table border="1" style="width:100%; border-collapse: collapse;"> <tr><td><input type="checkbox"/></td><td>2.5" 0.043" (1.09mm) 33 ksi (230 MPa)</td></tr> <tr><td><input checked="" type="checkbox"/></td><td>2.75" 0.054" (1.37mm) 50 ksi (340 MPa)</td></tr> <tr><td><input type="checkbox"/></td><td>4" 0.068" (1.73mm) 50 ksi (340 MPa)</td></tr> <tr><td><input type="checkbox"/></td><td>5" 0.043" (1.09) 33 ksi (230 MPa)</td></tr> <tr><td><input type="checkbox"/></td><td>Reduced section strap -- fuse = 2.5" wide x 30" long -- ends = 3.75" wide 0.043" (1.09mm) 33 ksi (230 MPa)</td></tr> <tr><td><input type="checkbox"/></td><td>Reduced section strap -- fuse = 2.75" wide x 30" long -- ends = 4.25" wide 0.054" (1.37mm) 50 ksi (340 MPa)</td></tr> <tr><td><input type="checkbox"/></td><td>Reduced section strap -- fuse = 4" wide x 30" long -- ends = 6" wide 0.068" (1.73mm) 50 ksi (340 MPa)</td></tr> <tr><td><input type="checkbox"/></td><td>Reduced section strap -- fuse = 2.5" wide x 60" long -- ends = 3.75" wide 0.043" (1.09mm) 33 ksi (230 MPa)</td></tr> <tr><td><input type="checkbox"/></td><td>Reduced section strap -- fuse = 4" wide x 60" long -- ends = 6" wide 0.068" (1.73mm) 50 ksi (340 MPa)</td></tr> </table>			<input type="checkbox"/>	2.5" 0.043" (1.09mm) 33 ksi (230 MPa)	<input checked="" type="checkbox"/>	2.75" 0.054" (1.37mm) 50 ksi (340 MPa)	<input type="checkbox"/>	4" 0.068" (1.73mm) 50 ksi (340 MPa)	<input type="checkbox"/>	5" 0.043" (1.09) 33 ksi (230 MPa)	<input type="checkbox"/>	Reduced section strap -- fuse = 2.5" wide x 30" long -- ends = 3.75" wide 0.043" (1.09mm) 33 ksi (230 MPa)	<input type="checkbox"/>	Reduced section strap -- fuse = 2.75" wide x 30" long -- ends = 4.25" wide 0.054" (1.37mm) 50 ksi (340 MPa)	<input type="checkbox"/>	Reduced section strap -- fuse = 4" wide x 30" long -- ends = 6" wide 0.068" (1.73mm) 50 ksi (340 MPa)	<input type="checkbox"/>	Reduced section strap -- fuse = 2.5" wide x 60" long -- ends = 3.75" wide 0.043" (1.09mm) 33 ksi (230 MPa)	<input type="checkbox"/>	Reduced section strap -- fuse = 4" wide x 60" long -- ends = 6" wide 0.068" (1.73mm) 50 ksi (340 MPa)																	
<input type="checkbox"/>	2.5" 0.043" (1.09mm) 33 ksi (230 MPa)																																					
<input checked="" type="checkbox"/>	2.75" 0.054" (1.37mm) 50 ksi (340 MPa)																																					
<input type="checkbox"/>	4" 0.068" (1.73mm) 50 ksi (340 MPa)																																					
<input type="checkbox"/>	5" 0.043" (1.09) 33 ksi (230 MPa)																																					
<input type="checkbox"/>	Reduced section strap -- fuse = 2.5" wide x 30" long -- ends = 3.75" wide 0.043" (1.09mm) 33 ksi (230 MPa)																																					
<input type="checkbox"/>	Reduced section strap -- fuse = 2.75" wide x 30" long -- ends = 4.25" wide 0.054" (1.37mm) 50 ksi (340 MPa)																																					
<input type="checkbox"/>	Reduced section strap -- fuse = 4" wide x 30" long -- ends = 6" wide 0.068" (1.73mm) 50 ksi (340 MPa)																																					
<input type="checkbox"/>	Reduced section strap -- fuse = 2.5" wide x 60" long -- ends = 3.75" wide 0.043" (1.09mm) 33 ksi (230 MPa)																																					
<input type="checkbox"/>	Reduced section strap -- fuse = 4" wide x 60" long -- ends = 6" wide 0.068" (1.73mm) 50 ksi (340 MPa)																																					
INTERIOR STUDS:	<table border="1" style="width:100%; border-collapse: collapse;"> <tr><td><input type="checkbox"/></td><td>3-5/8"Wx1-5/8"Fx1/2"Lip 0.043" (1.09mm) 33ksi (230 Mpa)</td></tr> <tr><td><input checked="" type="checkbox"/></td><td>6"Wx1-5/8"Fx1/2"Lip 0.043" (1.09mm) 33ksi (230 Mpa)</td></tr> </table>		<input type="checkbox"/>	3-5/8"Wx1-5/8"Fx1/2"Lip 0.043" (1.09mm) 33ksi (230 Mpa)	<input checked="" type="checkbox"/>	6"Wx1-5/8"Fx1/2"Lip 0.043" (1.09mm) 33ksi (230 Mpa)	STUD SPACING:																															
<input type="checkbox"/>	3-5/8"Wx1-5/8"Fx1/2"Lip 0.043" (1.09mm) 33ksi (230 Mpa)																																					
<input checked="" type="checkbox"/>	6"Wx1-5/8"Fx1/2"Lip 0.043" (1.09mm) 33ksi (230 Mpa)																																					
		<input checked="" type="checkbox"/>	16" O.C.																																			
		<input type="checkbox"/>	Other :																																			
BACK-TO-BACK CHORD STUDS:	<table border="1" style="width:100%; border-collapse: collapse;"> <tr><td><input type="checkbox"/></td><td>3-5/8"Wx1-5/8"Fx1/2"Lip 0.043" (1.09mm) 33ksi (230 Mpa)</td></tr> <tr><td><input checked="" type="checkbox"/></td><td>6"Wx1-5/8"Fx1/2"Lip 0.054" (1.37mm) 50ksi (345 Mpa)</td></tr> <tr><td><input type="checkbox"/></td><td>6"Wx1-5/8"Fx1/2"Lip 0.068" (1.73mm) 50ksi (345 Mpa)</td></tr> </table>			<input type="checkbox"/>	3-5/8"Wx1-5/8"Fx1/2"Lip 0.043" (1.09mm) 33ksi (230 Mpa)	<input checked="" type="checkbox"/>	6"Wx1-5/8"Fx1/2"Lip 0.054" (1.37mm) 50ksi (345 Mpa)	<input type="checkbox"/>	6"Wx1-5/8"Fx1/2"Lip 0.068" (1.73mm) 50ksi (345 Mpa)																													
<input type="checkbox"/>	3-5/8"Wx1-5/8"Fx1/2"Lip 0.043" (1.09mm) 33ksi (230 Mpa)																																					
<input checked="" type="checkbox"/>	6"Wx1-5/8"Fx1/2"Lip 0.054" (1.37mm) 50ksi (345 Mpa)																																					
<input type="checkbox"/>	6"Wx1-5/8"Fx1/2"Lip 0.068" (1.73mm) 50ksi (345 Mpa)																																					
CONNECTIONS:	<table border="1" style="width:100%; border-collapse: collapse;"> <tr><td><input type="checkbox"/></td><td>Straps</td><td>No.10 gauge 0.75" self-drilling wafer head (mod. Truss) Phillips drive</td></tr> <tr><td><input checked="" type="checkbox"/></td><td></td><td>1/8" fillet weld</td></tr> <tr><td><input type="checkbox"/></td><td>Framing:</td><td>No.8 gauge 0.5" self-drilling wafer head (mod. Truss) Phillips drive</td></tr> <tr><td><input checked="" type="checkbox"/></td><td>Hold downs:</td><td>No.14 gauge 1" self-drilling Hex washer head</td></tr> <tr><td><input type="checkbox"/></td><td>Back-to-Back</td><td></td></tr> <tr><td><input checked="" type="checkbox"/></td><td>Chord Studs:</td><td>No.10 gauge 0.75" self-drilling wafer head (mod. Truss) Phillips drive</td></tr> <tr><td><input type="checkbox"/></td><td>Anchor Rods</td><td>7/8" A193 Rod</td></tr> <tr><td><input checked="" type="checkbox"/></td><td></td><td>1" A193 Rod</td></tr> <tr><td><input type="checkbox"/></td><td>Loading Beam:</td><td>A325 3/4" bolts</td></tr> <tr><td><input checked="" type="checkbox"/></td><td>Base</td><td>A325 3/4" bolts</td></tr> </table>			<input type="checkbox"/>	Straps	No.10 gauge 0.75" self-drilling wafer head (mod. Truss) Phillips drive	<input checked="" type="checkbox"/>		1/8" fillet weld	<input type="checkbox"/>	Framing:	No.8 gauge 0.5" self-drilling wafer head (mod. Truss) Phillips drive	<input checked="" type="checkbox"/>	Hold downs:	No.14 gauge 1" self-drilling Hex washer head	<input type="checkbox"/>	Back-to-Back		<input checked="" type="checkbox"/>	Chord Studs:	No.10 gauge 0.75" self-drilling wafer head (mod. Truss) Phillips drive	<input type="checkbox"/>	Anchor Rods	7/8" A193 Rod	<input checked="" type="checkbox"/>		1" A193 Rod	<input type="checkbox"/>	Loading Beam:	A325 3/4" bolts	<input checked="" type="checkbox"/>	Base	A325 3/4" bolts					
<input type="checkbox"/>	Straps	No.10 gauge 0.75" self-drilling wafer head (mod. Truss) Phillips drive																																				
<input checked="" type="checkbox"/>		1/8" fillet weld																																				
<input type="checkbox"/>	Framing:	No.8 gauge 0.5" self-drilling wafer head (mod. Truss) Phillips drive																																				
<input checked="" type="checkbox"/>	Hold downs:	No.14 gauge 1" self-drilling Hex washer head																																				
<input type="checkbox"/>	Back-to-Back																																					
<input checked="" type="checkbox"/>	Chord Studs:	No.10 gauge 0.75" self-drilling wafer head (mod. Truss) Phillips drive																																				
<input type="checkbox"/>	Anchor Rods	7/8" A193 Rod																																				
<input checked="" type="checkbox"/>		1" A193 Rod																																				
<input type="checkbox"/>	Loading Beam:	A325 3/4" bolts																																				
<input checked="" type="checkbox"/>	Base	A325 3/4" bolts																																				
	10 bolts	<input checked="" type="checkbox"/>	2 Anchor Rods																																			
	6 bolts	<input checked="" type="checkbox"/>	2 Anchor Rods																																			
TRACK:	<table border="1" style="width:100%; border-collapse: collapse;"> <tr><td><input checked="" type="checkbox"/></td><td>Regular</td><td><input checked="" type="checkbox"/></td><td>6" web</td><td><input type="checkbox"/></td><td>0.043" (1.09mm) 33ksi (230 Mpa)</td></tr> <tr><td><input type="checkbox"/></td><td>Extended</td><td><input type="checkbox"/></td><td>3 5/8" web</td><td><input type="checkbox"/></td><td>0.054" (1.37mm) 50ksi (345 Mpa)</td></tr> <tr><td><input type="checkbox"/></td><td>Reinforced</td><td><input type="checkbox"/></td><td>1-1/4" flange</td><td><input checked="" type="checkbox"/></td><td>0.068" (1.73mm) 50ksi (345 Mpa)</td></tr> </table>			<input checked="" type="checkbox"/>	Regular	<input checked="" type="checkbox"/>	6" web	<input type="checkbox"/>	0.043" (1.09mm) 33ksi (230 Mpa)	<input type="checkbox"/>	Extended	<input type="checkbox"/>	3 5/8" web	<input type="checkbox"/>	0.054" (1.37mm) 50ksi (345 Mpa)	<input type="checkbox"/>	Reinforced	<input type="checkbox"/>	1-1/4" flange	<input checked="" type="checkbox"/>	0.068" (1.73mm) 50ksi (345 Mpa)																	
<input checked="" type="checkbox"/>	Regular	<input checked="" type="checkbox"/>	6" web	<input type="checkbox"/>	0.043" (1.09mm) 33ksi (230 Mpa)																																	
<input type="checkbox"/>	Extended	<input type="checkbox"/>	3 5/8" web	<input type="checkbox"/>	0.054" (1.37mm) 50ksi (345 Mpa)																																	
<input type="checkbox"/>	Reinforced	<input type="checkbox"/>	1-1/4" flange	<input checked="" type="checkbox"/>	0.068" (1.73mm) 50ksi (345 Mpa)																																	
HOLD DOWNS:	<table border="1" style="width:100%; border-collapse: collapse;"> <tr><td><input type="checkbox"/></td><td>S/HD10S Simpson</td><td>inside</td><td>outside</td><td>raised</td></tr> <tr><td><input type="checkbox"/></td><td>Fabricated U-shape</td><td></td><td></td><td></td></tr> <tr><td><input checked="" type="checkbox"/></td><td>6" x 6" 0.054" (1.37mm) 50 ksi (340 MPa) Gusset Plate w/ S/HD15S Simpson</td><td><input checked="" type="checkbox"/></td><td></td><td></td></tr> <tr><td><input type="checkbox"/></td><td>7" x 9" 0.054" (1.37mm) 50 ksi (340 MPa) Gusset Plate w/ S/HD15S Simpson</td><td></td><td></td><td></td></tr> <tr><td><input type="checkbox"/></td><td>8" x 8" 0.068" (1.73mm) 50 ksi (340 MPa) Gusset Plate w/ S/HD15S Simpson</td><td></td><td></td><td></td></tr> <tr><td><input type="checkbox"/></td><td>8.5" x10" 0.068" (1.73mm) 50 ksi (340 MPa) Gusset Plate w/ S/HD15S Simpson</td><td></td><td></td><td></td></tr> <tr><td><input type="checkbox"/></td><td>10" x10" 0.054" (1.37mm) 50 ksi (340 MPa) Gusset Plate w/ S/HD15S Simpson</td><td></td><td></td><td></td></tr> </table>			<input type="checkbox"/>	S/HD10S Simpson	inside	outside	raised	<input type="checkbox"/>	Fabricated U-shape				<input checked="" type="checkbox"/>	6" x 6" 0.054" (1.37mm) 50 ksi (340 MPa) Gusset Plate w/ S/HD15S Simpson	<input checked="" type="checkbox"/>			<input type="checkbox"/>	7" x 9" 0.054" (1.37mm) 50 ksi (340 MPa) Gusset Plate w/ S/HD15S Simpson				<input type="checkbox"/>	8" x 8" 0.068" (1.73mm) 50 ksi (340 MPa) Gusset Plate w/ S/HD15S Simpson				<input type="checkbox"/>	8.5" x10" 0.068" (1.73mm) 50 ksi (340 MPa) Gusset Plate w/ S/HD15S Simpson				<input type="checkbox"/>	10" x10" 0.054" (1.37mm) 50 ksi (340 MPa) Gusset Plate w/ S/HD15S Simpson			
<input type="checkbox"/>	S/HD10S Simpson	inside	outside	raised																																		
<input type="checkbox"/>	Fabricated U-shape																																					
<input checked="" type="checkbox"/>	6" x 6" 0.054" (1.37mm) 50 ksi (340 MPa) Gusset Plate w/ S/HD15S Simpson	<input checked="" type="checkbox"/>																																				
<input type="checkbox"/>	7" x 9" 0.054" (1.37mm) 50 ksi (340 MPa) Gusset Plate w/ S/HD15S Simpson																																					
<input type="checkbox"/>	8" x 8" 0.068" (1.73mm) 50 ksi (340 MPa) Gusset Plate w/ S/HD15S Simpson																																					
<input type="checkbox"/>	8.5" x10" 0.068" (1.73mm) 50 ksi (340 MPa) Gusset Plate w/ S/HD15S Simpson																																					
<input type="checkbox"/>	10" x10" 0.054" (1.37mm) 50 ksi (340 MPa) Gusset Plate w/ S/HD15S Simpson																																					
TEST PROTOCOL AND DESCRIPTION:	<table border="1" style="width:100%; border-collapse: collapse;"> <tr><td><input checked="" type="checkbox"/></td><td>Monotonic (Rate of Loading 2.5 mm/min)</td></tr> <tr><td><input type="checkbox"/></td><td>Cyclic (CUREE cyclic protocol)</td></tr> </table>			<input checked="" type="checkbox"/>	Monotonic (Rate of Loading 2.5 mm/min)	<input type="checkbox"/>	Cyclic (CUREE cyclic protocol)																															
<input checked="" type="checkbox"/>	Monotonic (Rate of Loading 2.5 mm/min)																																					
<input type="checkbox"/>	Cyclic (CUREE cyclic protocol)																																					
LVDT MEASUREMENTS:	<table border="1" style="width:100%; border-collapse: collapse;"> <tr><td><input checked="" type="checkbox"/></td><td>Actuator LVDT</td><td><input checked="" type="checkbox"/></td><td>North Uplift</td></tr> <tr><td><input checked="" type="checkbox"/></td><td>North Slip</td><td><input checked="" type="checkbox"/></td><td>South Uplift</td></tr> <tr><td><input checked="" type="checkbox"/></td><td>South Slip</td><td><input checked="" type="checkbox"/></td><td>Top of Wall</td></tr> </table>			<input checked="" type="checkbox"/>	Actuator LVDT	<input checked="" type="checkbox"/>	North Uplift	<input checked="" type="checkbox"/>	North Slip	<input checked="" type="checkbox"/>	South Uplift	<input checked="" type="checkbox"/>	South Slip	<input checked="" type="checkbox"/>	Top of Wall																							
<input checked="" type="checkbox"/>	Actuator LVDT	<input checked="" type="checkbox"/>	North Uplift																																			
<input checked="" type="checkbox"/>	North Slip	<input checked="" type="checkbox"/>	South Uplift																																			
<input checked="" type="checkbox"/>	South Slip	<input checked="" type="checkbox"/>	Top of Wall																																			
TOTAL: <input type="text" value="6"/>																																						
STRAP WIDTH BEFORE TEST:	<table border="1" style="width:100%; border-collapse: collapse;"> <tr><td>Front Right</td><td>Front Left, mm</td><td>Back Right, mm</td><td>Back Left, mm</td></tr> <tr><td>70.53</td><td>70.83</td><td>69.41</td><td>70.61</td></tr> <tr><td>70.67</td><td>70.07</td><td>70.50</td><td>69.50</td></tr> <tr><td>70.86</td><td>71.53</td><td>70.65</td><td>70.01</td></tr> <tr><td>AVG</td><td>70.69 mm</td><td>AVG</td><td>70.19 mm</td></tr> <tr><td></td><td></td><td>AVG</td><td>70.04 mm</td></tr> </table>			Front Right	Front Left, mm	Back Right, mm	Back Left, mm	70.53	70.83	69.41	70.61	70.67	70.07	70.50	69.50	70.86	71.53	70.65	70.01	AVG	70.69 mm	AVG	70.19 mm			AVG	70.04 mm											
Front Right	Front Left, mm	Back Right, mm	Back Left, mm																																			
70.53	70.83	69.41	70.61																																			
70.67	70.07	70.50	69.50																																			
70.86	71.53	70.65	70.01																																			
AVG	70.69 mm	AVG	70.19 mm																																			
		AVG	70.04 mm																																			
DATA ACQ. RECORD RATE:	1 scan/sec		MONITOR RATE:																																			
		10 scan/sec																																				
COMMENTS:	<ul style="list-style-type: none"> -Shear anchors torqued for 10 s with impact wrench -Hold down anchors 1/2 turn from finger tight(top), load cells used on both bottom hold-downs -Double chord studs used screwed back to back -Square plate washers (2.5"x2.5") used in all top track connections -Regular washers used in all bottom track connections 																																					

Figure E.9: Data sheet for test 19A-M

Cold Formed Steel Strap Braced Walls McGill University, Montreal																																																							
TEST:		19 B-M																																																					
RESEARCHER:	Gilles Comeau		ASSISTANTS:																																																				
		Kostadin Velchev, Nisreen Balh																																																					
DATE:	17-Jul-07		TIME:																																																				
		4:00PM																																																					
DIMENSIONS OF WALL:	2 FT X	8 FT X	6 IN.																																																				
INITIAL STRAP SURVEY:	Front	Right	Left																																																				
	Back	Tight	Loose																																																				
		Tight	Loose																																																				
STRAP FASTENER CONFIGURATION: MFR: McGill																																																							
STRAP SIZE:	<table border="1" style="width:100%; border-collapse: collapse;"> <tr><td><input type="checkbox"/></td><td>2.5" 0.043" (1.09mm) 33 ksi (230 MPa)</td></tr> <tr><td><input checked="" type="checkbox"/></td><td>2.75" 0.054" (1.37mm) 50 ksi (340 MPa)</td></tr> <tr><td><input type="checkbox"/></td><td>4" 0.068" (1.73mm) 50 ksi (340 MPa)</td></tr> <tr><td><input type="checkbox"/></td><td>5" 0.043" (1.09) 33 ksi (230 MPa)</td></tr> <tr><td><input type="checkbox"/></td><td>Reduced section strap -- fuse = 2.5" wide x 30" long -- ends = 3.75" wide 0.043" (1.09mm) 33 ksi (230 MPa)</td></tr> <tr><td><input type="checkbox"/></td><td>Reduced section strap -- fuse = 2.75" wide x 30" long -- ends = 4.25" wide 0.054" (1.37mm) 50 ksi (340 MPa)</td></tr> <tr><td><input type="checkbox"/></td><td>Reduced section strap -- fuse = 4" wide x 30" long -- ends = 6" wide 0.068" (1.73mm) 50 ksi (340 MPa)</td></tr> <tr><td><input type="checkbox"/></td><td>Reduced section strap -- fuse = 2.5" wide x 60" long -- ends = 3.75" wide 0.043" (1.09mm) 33 ksi (230 MPa)</td></tr> <tr><td><input type="checkbox"/></td><td>Reduced section strap -- fuse = 4" wide x 60" long -- ends = 6" wide 0.068" (1.73mm) 50 ksi (340 MPa)</td></tr> </table>			<input type="checkbox"/>	2.5" 0.043" (1.09mm) 33 ksi (230 MPa)	<input checked="" type="checkbox"/>	2.75" 0.054" (1.37mm) 50 ksi (340 MPa)	<input type="checkbox"/>	4" 0.068" (1.73mm) 50 ksi (340 MPa)	<input type="checkbox"/>	5" 0.043" (1.09) 33 ksi (230 MPa)	<input type="checkbox"/>	Reduced section strap -- fuse = 2.5" wide x 30" long -- ends = 3.75" wide 0.043" (1.09mm) 33 ksi (230 MPa)	<input type="checkbox"/>	Reduced section strap -- fuse = 2.75" wide x 30" long -- ends = 4.25" wide 0.054" (1.37mm) 50 ksi (340 MPa)	<input type="checkbox"/>	Reduced section strap -- fuse = 4" wide x 30" long -- ends = 6" wide 0.068" (1.73mm) 50 ksi (340 MPa)	<input type="checkbox"/>	Reduced section strap -- fuse = 2.5" wide x 60" long -- ends = 3.75" wide 0.043" (1.09mm) 33 ksi (230 MPa)	<input type="checkbox"/>	Reduced section strap -- fuse = 4" wide x 60" long -- ends = 6" wide 0.068" (1.73mm) 50 ksi (340 MPa)																																		
<input type="checkbox"/>	2.5" 0.043" (1.09mm) 33 ksi (230 MPa)																																																						
<input checked="" type="checkbox"/>	2.75" 0.054" (1.37mm) 50 ksi (340 MPa)																																																						
<input type="checkbox"/>	4" 0.068" (1.73mm) 50 ksi (340 MPa)																																																						
<input type="checkbox"/>	5" 0.043" (1.09) 33 ksi (230 MPa)																																																						
<input type="checkbox"/>	Reduced section strap -- fuse = 2.5" wide x 30" long -- ends = 3.75" wide 0.043" (1.09mm) 33 ksi (230 MPa)																																																						
<input type="checkbox"/>	Reduced section strap -- fuse = 2.75" wide x 30" long -- ends = 4.25" wide 0.054" (1.37mm) 50 ksi (340 MPa)																																																						
<input type="checkbox"/>	Reduced section strap -- fuse = 4" wide x 30" long -- ends = 6" wide 0.068" (1.73mm) 50 ksi (340 MPa)																																																						
<input type="checkbox"/>	Reduced section strap -- fuse = 2.5" wide x 60" long -- ends = 3.75" wide 0.043" (1.09mm) 33 ksi (230 MPa)																																																						
<input type="checkbox"/>	Reduced section strap -- fuse = 4" wide x 60" long -- ends = 6" wide 0.068" (1.73mm) 50 ksi (340 MPa)																																																						
INTERIOR STUDS:	<table border="1" style="width:100%; border-collapse: collapse;"> <tr><td><input type="checkbox"/></td><td>3-5/8"Wx1-5/8"Fx1/2"Lip 0.043" (1.09mm) 33ksi (230 Mpa)</td></tr> <tr><td><input checked="" type="checkbox"/></td><td>6"Wx1-5/8"Fx1/2"Lip 0.043" (1.09mm) 33ksi (230 Mpa)</td></tr> </table>		<input type="checkbox"/>	3-5/8"Wx1-5/8"Fx1/2"Lip 0.043" (1.09mm) 33ksi (230 Mpa)	<input checked="" type="checkbox"/>	6"Wx1-5/8"Fx1/2"Lip 0.043" (1.09mm) 33ksi (230 Mpa)	STUD SPACING:																																																
<input type="checkbox"/>	3-5/8"Wx1-5/8"Fx1/2"Lip 0.043" (1.09mm) 33ksi (230 Mpa)																																																						
<input checked="" type="checkbox"/>	6"Wx1-5/8"Fx1/2"Lip 0.043" (1.09mm) 33ksi (230 Mpa)																																																						
		<input checked="" type="checkbox"/>	16" O.C.																																																				
		<input type="checkbox"/>	Other :																																																				
BACK-TO-BACK CHORD STUDS:	<table border="1" style="width:100%; border-collapse: collapse;"> <tr><td><input type="checkbox"/></td><td>3-5/8"Wx1-5/8"Fx1/2"Lip 0.043" (1.09mm) 33ksi (230 Mpa)</td></tr> <tr><td><input checked="" type="checkbox"/></td><td>6"Wx1-5/8"Fx1/2"Lip 0.054" (1.37mm) 50ksi (345 Mpa)</td></tr> <tr><td><input type="checkbox"/></td><td>6"Wx1-5/8"Fx1/2"Lip 0.068" (1.73mm) 50ksi (345 Mpa)</td></tr> </table>			<input type="checkbox"/>	3-5/8"Wx1-5/8"Fx1/2"Lip 0.043" (1.09mm) 33ksi (230 Mpa)	<input checked="" type="checkbox"/>	6"Wx1-5/8"Fx1/2"Lip 0.054" (1.37mm) 50ksi (345 Mpa)	<input type="checkbox"/>	6"Wx1-5/8"Fx1/2"Lip 0.068" (1.73mm) 50ksi (345 Mpa)																																														
<input type="checkbox"/>	3-5/8"Wx1-5/8"Fx1/2"Lip 0.043" (1.09mm) 33ksi (230 Mpa)																																																						
<input checked="" type="checkbox"/>	6"Wx1-5/8"Fx1/2"Lip 0.054" (1.37mm) 50ksi (345 Mpa)																																																						
<input type="checkbox"/>	6"Wx1-5/8"Fx1/2"Lip 0.068" (1.73mm) 50ksi (345 Mpa)																																																						
CONNECTIONS:	<table border="1" style="width:100%; border-collapse: collapse;"> <tr><td colspan="4">Straps</td></tr> <tr><td><input checked="" type="checkbox"/></td><td>No.10 gauge 0.75" self-drilling wafer head (mod. Truss) Phillips drive</td><td></td><td></td></tr> <tr><td><input type="checkbox"/></td><td>1/8" fillet weld</td><td></td><td></td></tr> <tr><td colspan="4">Framing:</td></tr> <tr><td><input checked="" type="checkbox"/></td><td>No.8 gauge 0.5" self-drilling wafer head (mod. Truss) Phillips drive</td><td></td><td></td></tr> <tr><td><input type="checkbox"/></td><td>No.14 gauge 1" self-drilling Hex washer head</td><td></td><td></td></tr> <tr><td colspan="4">Back-to-Back</td></tr> <tr><td><input type="checkbox"/></td><td>No.10 gauge 0.75" self-drilling wafer head (mod. Truss) Phillips drive</td><td></td><td></td></tr> <tr><td><input type="checkbox"/></td><td>7/8" A193 Rod</td><td></td><td></td></tr> <tr><td><input type="checkbox"/></td><td>1" A193 Rod</td><td></td><td></td></tr> <tr><td colspan="4">Chord Studs:</td></tr> <tr><td><input checked="" type="checkbox"/></td><td>A325 3/4" bolts</td><td>1 bolts <input checked="" type="checkbox"/></td><td>2 Anchor Rods <input checked="" type="checkbox"/></td></tr> <tr><td><input type="checkbox"/></td><td>A325 3/4" bolts</td><td>1 bolts <input type="checkbox"/></td><td>2 Anchor Rods <input type="checkbox"/></td></tr> </table>			Straps				<input checked="" type="checkbox"/>	No.10 gauge 0.75" self-drilling wafer head (mod. Truss) Phillips drive			<input type="checkbox"/>	1/8" fillet weld			Framing:				<input checked="" type="checkbox"/>	No.8 gauge 0.5" self-drilling wafer head (mod. Truss) Phillips drive			<input type="checkbox"/>	No.14 gauge 1" self-drilling Hex washer head			Back-to-Back				<input type="checkbox"/>	No.10 gauge 0.75" self-drilling wafer head (mod. Truss) Phillips drive			<input type="checkbox"/>	7/8" A193 Rod			<input type="checkbox"/>	1" A193 Rod			Chord Studs:				<input checked="" type="checkbox"/>	A325 3/4" bolts	1 bolts <input checked="" type="checkbox"/>	2 Anchor Rods <input checked="" type="checkbox"/>	<input type="checkbox"/>	A325 3/4" bolts	1 bolts <input type="checkbox"/>	2 Anchor Rods <input type="checkbox"/>
Straps																																																							
<input checked="" type="checkbox"/>	No.10 gauge 0.75" self-drilling wafer head (mod. Truss) Phillips drive																																																						
<input type="checkbox"/>	1/8" fillet weld																																																						
Framing:																																																							
<input checked="" type="checkbox"/>	No.8 gauge 0.5" self-drilling wafer head (mod. Truss) Phillips drive																																																						
<input type="checkbox"/>	No.14 gauge 1" self-drilling Hex washer head																																																						
Back-to-Back																																																							
<input type="checkbox"/>	No.10 gauge 0.75" self-drilling wafer head (mod. Truss) Phillips drive																																																						
<input type="checkbox"/>	7/8" A193 Rod																																																						
<input type="checkbox"/>	1" A193 Rod																																																						
Chord Studs:																																																							
<input checked="" type="checkbox"/>	A325 3/4" bolts	1 bolts <input checked="" type="checkbox"/>	2 Anchor Rods <input checked="" type="checkbox"/>																																																				
<input type="checkbox"/>	A325 3/4" bolts	1 bolts <input type="checkbox"/>	2 Anchor Rods <input type="checkbox"/>																																																				
TRACK:	<table border="1" style="width:100%; border-collapse: collapse;"> <tr><td><input checked="" type="checkbox"/></td><td>Regular</td><td><input checked="" type="checkbox"/></td><td>6" web</td><td><input type="checkbox"/></td><td>0.043" (1.09mm) 33ksi (230 Mpa)</td></tr> <tr><td><input type="checkbox"/></td><td>Extended</td><td><input type="checkbox"/></td><td>3 5/8" web</td><td><input type="checkbox"/></td><td>0.054" (1.37mm) 50ksi (345 Mpa)</td></tr> <tr><td><input type="checkbox"/></td><td>Reinforced</td><td><input type="checkbox"/></td><td>1-1/4" flange</td><td><input checked="" type="checkbox"/></td><td>0.068" (1.73mm) 50ksi (345 Mpa)</td></tr> </table>			<input checked="" type="checkbox"/>	Regular	<input checked="" type="checkbox"/>	6" web	<input type="checkbox"/>	0.043" (1.09mm) 33ksi (230 Mpa)	<input type="checkbox"/>	Extended	<input type="checkbox"/>	3 5/8" web	<input type="checkbox"/>	0.054" (1.37mm) 50ksi (345 Mpa)	<input type="checkbox"/>	Reinforced	<input type="checkbox"/>	1-1/4" flange	<input checked="" type="checkbox"/>	0.068" (1.73mm) 50ksi (345 Mpa)																																		
<input checked="" type="checkbox"/>	Regular	<input checked="" type="checkbox"/>	6" web	<input type="checkbox"/>	0.043" (1.09mm) 33ksi (230 Mpa)																																																		
<input type="checkbox"/>	Extended	<input type="checkbox"/>	3 5/8" web	<input type="checkbox"/>	0.054" (1.37mm) 50ksi (345 Mpa)																																																		
<input type="checkbox"/>	Reinforced	<input type="checkbox"/>	1-1/4" flange	<input checked="" type="checkbox"/>	0.068" (1.73mm) 50ksi (345 Mpa)																																																		
HOLD DOWNS:	<table border="1" style="width:100%; border-collapse: collapse;"> <tr><td><input type="checkbox"/></td><td>S/HD10S Simpson</td><td></td><td></td><td></td><td></td></tr> <tr><td><input type="checkbox"/></td><td>Fabricated U-shape</td><td></td><td></td><td></td><td></td></tr> <tr><td><input checked="" type="checkbox"/></td><td>6" x 6" 0.054" (1.37mm) 50 ksi (340 MPa) Gusset Plate w/ S/HD15S Simpson</td><td></td><td></td><td></td><td></td></tr> <tr><td><input type="checkbox"/></td><td>7" x 9" 0.054" (1.37mm) 50 ksi (340 MPa) Gusset Plate w/ S/HD15S Simpson</td><td></td><td></td><td></td><td></td></tr> <tr><td><input type="checkbox"/></td><td>8" x 8" 0.068" (1.73mm) 50 ksi (340 MPa) Gusset Plate w/ S/HD15S Simpson</td><td></td><td></td><td></td><td></td></tr> <tr><td><input type="checkbox"/></td><td>8.5" x10" 0.068" (1.73mm) 50 ksi (340 MPa) Gusset Plate w/ S/HD15S Simpson</td><td></td><td></td><td></td><td></td></tr> <tr><td><input type="checkbox"/></td><td>10" x10" 0.054" (1.37mm) 50 ksi (340 MPa) Gusset Plate w/ S/HD15S Simpson</td><td></td><td></td><td></td><td></td></tr> </table>			<input type="checkbox"/>	S/HD10S Simpson					<input type="checkbox"/>	Fabricated U-shape					<input checked="" type="checkbox"/>	6" x 6" 0.054" (1.37mm) 50 ksi (340 MPa) Gusset Plate w/ S/HD15S Simpson					<input type="checkbox"/>	7" x 9" 0.054" (1.37mm) 50 ksi (340 MPa) Gusset Plate w/ S/HD15S Simpson					<input type="checkbox"/>	8" x 8" 0.068" (1.73mm) 50 ksi (340 MPa) Gusset Plate w/ S/HD15S Simpson					<input type="checkbox"/>	8.5" x10" 0.068" (1.73mm) 50 ksi (340 MPa) Gusset Plate w/ S/HD15S Simpson					<input type="checkbox"/>	10" x10" 0.054" (1.37mm) 50 ksi (340 MPa) Gusset Plate w/ S/HD15S Simpson														
<input type="checkbox"/>	S/HD10S Simpson																																																						
<input type="checkbox"/>	Fabricated U-shape																																																						
<input checked="" type="checkbox"/>	6" x 6" 0.054" (1.37mm) 50 ksi (340 MPa) Gusset Plate w/ S/HD15S Simpson																																																						
<input type="checkbox"/>	7" x 9" 0.054" (1.37mm) 50 ksi (340 MPa) Gusset Plate w/ S/HD15S Simpson																																																						
<input type="checkbox"/>	8" x 8" 0.068" (1.73mm) 50 ksi (340 MPa) Gusset Plate w/ S/HD15S Simpson																																																						
<input type="checkbox"/>	8.5" x10" 0.068" (1.73mm) 50 ksi (340 MPa) Gusset Plate w/ S/HD15S Simpson																																																						
<input type="checkbox"/>	10" x10" 0.054" (1.37mm) 50 ksi (340 MPa) Gusset Plate w/ S/HD15S Simpson																																																						
TEST PROTOCOL AND DESCRIPTION:	<table border="1" style="width:100%; border-collapse: collapse;"> <tr><td><input checked="" type="checkbox"/></td><td>Monotonic (Rate of Loading 2.5 mm/min)</td></tr> <tr><td><input type="checkbox"/></td><td>Cyclic (CUREE cyclic protocol)</td></tr> </table>			<input checked="" type="checkbox"/>	Monotonic (Rate of Loading 2.5 mm/min)	<input type="checkbox"/>	Cyclic (CUREE cyclic protocol)																																																
<input checked="" type="checkbox"/>	Monotonic (Rate of Loading 2.5 mm/min)																																																						
<input type="checkbox"/>	Cyclic (CUREE cyclic protocol)																																																						
LVDT MEASUREMENTS:	<table border="1" style="width:100%; border-collapse: collapse;"> <tr><td><input checked="" type="checkbox"/></td><td>Actuator LVDT</td><td><input checked="" type="checkbox"/></td><td>North Uplift</td></tr> <tr><td><input checked="" type="checkbox"/></td><td>North Slip</td><td><input checked="" type="checkbox"/></td><td>South Uplift</td></tr> <tr><td><input checked="" type="checkbox"/></td><td>South Slip</td><td><input checked="" type="checkbox"/></td><td>Top of Wall</td></tr> </table>			<input checked="" type="checkbox"/>	Actuator LVDT	<input checked="" type="checkbox"/>	North Uplift	<input checked="" type="checkbox"/>	North Slip	<input checked="" type="checkbox"/>	South Uplift	<input checked="" type="checkbox"/>	South Slip	<input checked="" type="checkbox"/>	Top of Wall																																								
<input checked="" type="checkbox"/>	Actuator LVDT	<input checked="" type="checkbox"/>	North Uplift																																																				
<input checked="" type="checkbox"/>	North Slip	<input checked="" type="checkbox"/>	South Uplift																																																				
<input checked="" type="checkbox"/>	South Slip	<input checked="" type="checkbox"/>	Top of Wall																																																				
TOTAL: <input type="text" value="6"/>																																																							
STRAP WIDTH BEFORE TEST:	<table border="1" style="width:100%; border-collapse: collapse;"> <tr><td>Front Right</td><td>Front Left, mm</td><td>Back Right, mm</td><td>Back Left, mm</td></tr> <tr><td>70.77</td><td>70.71</td><td>70.51</td><td>70.72</td></tr> <tr><td>70.32</td><td>70.26</td><td>70.37</td><td>70.44</td></tr> <tr><td>70.00</td><td>70.27</td><td>70.13</td><td>70.14</td></tr> <tr><td>AVG</td><td>70.36 mm</td><td>AVG</td><td>70.41 mm</td></tr> <tr><td></td><td></td><td>AVG</td><td>70.34 mm</td></tr> <tr><td></td><td></td><td>AVG</td><td>70.43 mm</td></tr> </table>			Front Right	Front Left, mm	Back Right, mm	Back Left, mm	70.77	70.71	70.51	70.72	70.32	70.26	70.37	70.44	70.00	70.27	70.13	70.14	AVG	70.36 mm	AVG	70.41 mm			AVG	70.34 mm			AVG	70.43 mm																								
Front Right	Front Left, mm	Back Right, mm	Back Left, mm																																																				
70.77	70.71	70.51	70.72																																																				
70.32	70.26	70.37	70.44																																																				
70.00	70.27	70.13	70.14																																																				
AVG	70.36 mm	AVG	70.41 mm																																																				
		AVG	70.34 mm																																																				
		AVG	70.43 mm																																																				
DATA ACQ. RECORD RATE:	1 scan/sec		MONITOR RATE:																																																				
		10 scan/sec																																																					
COMMENTS:	<ul style="list-style-type: none"> -Shear anchors torqued for 10 s with impact wrench -Hold down anchors 1/2 turn from finger tight(top), load cells used on both bottom hold-downs -Double chord studs used screwed back to back -Square plate washers (2.5"x2.5") used in all top track connections -Regular washers used in all bottom track connections 																																																						

Figure E.11: Data sheet for test 19B-M

Cold Formed Steel Strap Braced Walls McGill University, Montreal																																
TEST:		21A-M																														
RESEARCHER:	Gilles Comeau		ASSISTANTS:	Kostadin Velchev, Nisreen Bah																												
DATE:	19-Jun-07		TIME:	3:00PM																												
DIMENSIONS OF WALL:	8 FT X	8 FT X	6 IN.	INITIAL STRAP SURVEY:	Front Right Back Left Tight Tight Tight Tight																											
STRAP FASTENER CONFIGURATION:				MFR: McGill																												
STRAP SIZE:	<table border="1" style="width:100%; border-collapse: collapse;"> <tr><td><input type="checkbox"/></td><td>2.5" 0.043" (1.09mm) 33 ksi (230 MPa)</td></tr> <tr><td><input type="checkbox"/></td><td>2.75" 0.054" (1.37mm) 50 ksi (340 MPa)</td></tr> <tr><td><input checked="" type="checkbox"/></td><td>4" 0.068" (1.73mm) 50 ksi (340 MPa)</td></tr> <tr><td><input type="checkbox"/></td><td>5" 0.043" (1.09) 33 ksi (230 MPa)</td></tr> <tr><td><input type="checkbox"/></td><td>Reduced section strap -- fuse = 2.5" wide x 30" long -- ends = 3.75" wide 0.043" (1.09mm) 33 ksi (230 MPa)</td></tr> <tr><td><input type="checkbox"/></td><td>Reduced section strap -- fuse = 2.75" wide x 30" long -- ends = 4.25" wide 0.054" (1.37mm) 50 ksi (340 MPa)</td></tr> <tr><td><input type="checkbox"/></td><td>Reduced section strap -- fuse = 4" wide x 30" long -- ends = 6" wide 0.068" (1.73mm) 50 ksi (340 MPa)</td></tr> <tr><td><input type="checkbox"/></td><td>Reduced section strap -- fuse = 2.5" wide x 60" long -- ends = 3.75" wide 0.043" (1.09mm) 33 ksi (230 MPa)</td></tr> <tr><td><input type="checkbox"/></td><td>Reduced section strap -- fuse = 4" wide x 60" long -- ends = 6" wide 0.068" (1.73mm) 50 ksi (340 MPa)</td></tr> </table>				<input type="checkbox"/>	2.5" 0.043" (1.09mm) 33 ksi (230 MPa)	<input type="checkbox"/>	2.75" 0.054" (1.37mm) 50 ksi (340 MPa)	<input checked="" type="checkbox"/>	4" 0.068" (1.73mm) 50 ksi (340 MPa)	<input type="checkbox"/>	5" 0.043" (1.09) 33 ksi (230 MPa)	<input type="checkbox"/>	Reduced section strap -- fuse = 2.5" wide x 30" long -- ends = 3.75" wide 0.043" (1.09mm) 33 ksi (230 MPa)	<input type="checkbox"/>	Reduced section strap -- fuse = 2.75" wide x 30" long -- ends = 4.25" wide 0.054" (1.37mm) 50 ksi (340 MPa)	<input type="checkbox"/>	Reduced section strap -- fuse = 4" wide x 30" long -- ends = 6" wide 0.068" (1.73mm) 50 ksi (340 MPa)	<input type="checkbox"/>	Reduced section strap -- fuse = 2.5" wide x 60" long -- ends = 3.75" wide 0.043" (1.09mm) 33 ksi (230 MPa)	<input type="checkbox"/>	Reduced section strap -- fuse = 4" wide x 60" long -- ends = 6" wide 0.068" (1.73mm) 50 ksi (340 MPa)										
<input type="checkbox"/>	2.5" 0.043" (1.09mm) 33 ksi (230 MPa)																															
<input type="checkbox"/>	2.75" 0.054" (1.37mm) 50 ksi (340 MPa)																															
<input checked="" type="checkbox"/>	4" 0.068" (1.73mm) 50 ksi (340 MPa)																															
<input type="checkbox"/>	5" 0.043" (1.09) 33 ksi (230 MPa)																															
<input type="checkbox"/>	Reduced section strap -- fuse = 2.5" wide x 30" long -- ends = 3.75" wide 0.043" (1.09mm) 33 ksi (230 MPa)																															
<input type="checkbox"/>	Reduced section strap -- fuse = 2.75" wide x 30" long -- ends = 4.25" wide 0.054" (1.37mm) 50 ksi (340 MPa)																															
<input type="checkbox"/>	Reduced section strap -- fuse = 4" wide x 30" long -- ends = 6" wide 0.068" (1.73mm) 50 ksi (340 MPa)																															
<input type="checkbox"/>	Reduced section strap -- fuse = 2.5" wide x 60" long -- ends = 3.75" wide 0.043" (1.09mm) 33 ksi (230 MPa)																															
<input type="checkbox"/>	Reduced section strap -- fuse = 4" wide x 60" long -- ends = 6" wide 0.068" (1.73mm) 50 ksi (340 MPa)																															
INTERIOR STUDS:	<table border="1" style="width:100%; border-collapse: collapse;"> <tr><td><input type="checkbox"/></td><td>3-5/8"Wx1-5/8"Fx1/2"Lip 0.043" (1.09mm) 33ksi (230 Mpa)</td></tr> <tr><td><input checked="" type="checkbox"/></td><td>6"Wx1-5/8"Fx1/2"Lip 0.043" (1.09mm) 33ksi (230 Mpa)</td></tr> </table>		<input type="checkbox"/>	3-5/8"Wx1-5/8"Fx1/2"Lip 0.043" (1.09mm) 33ksi (230 Mpa)	<input checked="" type="checkbox"/>	6"Wx1-5/8"Fx1/2"Lip 0.043" (1.09mm) 33ksi (230 Mpa)	STUD SPACING:	<table border="1" style="width:100%; border-collapse: collapse;"> <tr><td><input checked="" type="checkbox"/></td><td>16" O.C.</td></tr> <tr><td><input type="checkbox"/></td><td>Other :</td></tr> </table>		<input checked="" type="checkbox"/>	16" O.C.	<input type="checkbox"/>	Other :																			
<input type="checkbox"/>	3-5/8"Wx1-5/8"Fx1/2"Lip 0.043" (1.09mm) 33ksi (230 Mpa)																															
<input checked="" type="checkbox"/>	6"Wx1-5/8"Fx1/2"Lip 0.043" (1.09mm) 33ksi (230 Mpa)																															
<input checked="" type="checkbox"/>	16" O.C.																															
<input type="checkbox"/>	Other :																															
BACK-TO-BACK CHORD STUDS:	<table border="1" style="width:100%; border-collapse: collapse;"> <tr><td><input type="checkbox"/></td><td>3-5/8"Wx1-5/8"Fx1/2"Lip 0.043" (1.09mm) 33ksi (230 Mpa)</td></tr> <tr><td><input type="checkbox"/></td><td>6"Wx1-5/8"Fx1/2"Lip 0.054" (1.37mm) 50ksi (345 Mpa)</td></tr> <tr><td><input checked="" type="checkbox"/></td><td>6"Wx1-5/8"Fx1/2"Lip 0.068" (1.73mm) 50ksi (345 Mpa)</td></tr> </table>				<input type="checkbox"/>	3-5/8"Wx1-5/8"Fx1/2"Lip 0.043" (1.09mm) 33ksi (230 Mpa)	<input type="checkbox"/>	6"Wx1-5/8"Fx1/2"Lip 0.054" (1.37mm) 50ksi (345 Mpa)	<input checked="" type="checkbox"/>	6"Wx1-5/8"Fx1/2"Lip 0.068" (1.73mm) 50ksi (345 Mpa)																						
<input type="checkbox"/>	3-5/8"Wx1-5/8"Fx1/2"Lip 0.043" (1.09mm) 33ksi (230 Mpa)																															
<input type="checkbox"/>	6"Wx1-5/8"Fx1/2"Lip 0.054" (1.37mm) 50ksi (345 Mpa)																															
<input checked="" type="checkbox"/>	6"Wx1-5/8"Fx1/2"Lip 0.068" (1.73mm) 50ksi (345 Mpa)																															
CONNECTIONS:	<table border="1" style="width:100%; border-collapse: collapse;"> <tr><td><input checked="" type="checkbox"/></td><td>No.10 gauge 0.75" self-drilling wafer head (mod. Truss) Phillips drive</td></tr> <tr><td><input checked="" type="checkbox"/></td><td>No.8 gauge 0.5" self-drilling wafer head (mod. Truss) Phillips drive</td></tr> <tr><td><input checked="" type="checkbox"/></td><td>No.14 gauge 1" self-drilling Hex washer head</td></tr> <tr><td><input checked="" type="checkbox"/></td><td>No.10 gauge 0.75" self-drilling Hex washer head</td></tr> <tr><td><input type="checkbox"/></td><td>7/8" A193 Rod</td></tr> <tr><td><input checked="" type="checkbox"/></td><td>1" A193 Rod</td></tr> <tr><td><input checked="" type="checkbox"/></td><td>A325 3/4" bolts</td></tr> <tr><td><input checked="" type="checkbox"/></td><td>A325 3/4" bolts</td></tr> </table>				<input checked="" type="checkbox"/>	No.10 gauge 0.75" self-drilling wafer head (mod. Truss) Phillips drive	<input checked="" type="checkbox"/>	No.8 gauge 0.5" self-drilling wafer head (mod. Truss) Phillips drive	<input checked="" type="checkbox"/>	No.14 gauge 1" self-drilling Hex washer head	<input checked="" type="checkbox"/>	No.10 gauge 0.75" self-drilling Hex washer head	<input type="checkbox"/>	7/8" A193 Rod	<input checked="" type="checkbox"/>	1" A193 Rod	<input checked="" type="checkbox"/>	A325 3/4" bolts	<input checked="" type="checkbox"/>	A325 3/4" bolts												
<input checked="" type="checkbox"/>	No.10 gauge 0.75" self-drilling wafer head (mod. Truss) Phillips drive																															
<input checked="" type="checkbox"/>	No.8 gauge 0.5" self-drilling wafer head (mod. Truss) Phillips drive																															
<input checked="" type="checkbox"/>	No.14 gauge 1" self-drilling Hex washer head																															
<input checked="" type="checkbox"/>	No.10 gauge 0.75" self-drilling Hex washer head																															
<input type="checkbox"/>	7/8" A193 Rod																															
<input checked="" type="checkbox"/>	1" A193 Rod																															
<input checked="" type="checkbox"/>	A325 3/4" bolts																															
<input checked="" type="checkbox"/>	A325 3/4" bolts																															
TRACK:	<table border="1" style="width:100%; border-collapse: collapse;"> <tr><td><input checked="" type="checkbox"/></td><td>Regular</td></tr> <tr><td><input type="checkbox"/></td><td>Extended</td></tr> <tr><td><input type="checkbox"/></td><td>Reinforced</td></tr> </table>		<input checked="" type="checkbox"/>	Regular	<input type="checkbox"/>	Extended	<input type="checkbox"/>	Reinforced	<table border="1" style="width:100%; border-collapse: collapse;"> <tr><td><input checked="" type="checkbox"/></td><td>6" web</td></tr> <tr><td><input type="checkbox"/></td><td>3 5/8" web</td></tr> <tr><td><input type="checkbox"/></td><td>1-1/4" flange</td></tr> </table>		<input checked="" type="checkbox"/>	6" web	<input type="checkbox"/>	3 5/8" web	<input type="checkbox"/>	1-1/4" flange																
<input checked="" type="checkbox"/>	Regular																															
<input type="checkbox"/>	Extended																															
<input type="checkbox"/>	Reinforced																															
<input checked="" type="checkbox"/>	6" web																															
<input type="checkbox"/>	3 5/8" web																															
<input type="checkbox"/>	1-1/4" flange																															
HOLD DOWNS:	<table border="1" style="width:100%; border-collapse: collapse;"> <tr><td><input type="checkbox"/></td><td>S/HD10S Simpson</td></tr> <tr><td><input type="checkbox"/></td><td>Fabricated U-shape</td></tr> <tr><td><input type="checkbox"/></td><td>6" x 6" 0.054" (1.37mm) 50 ksi (340 MPa) Gusset Plate w/ S/HD15S Simpson</td></tr> <tr><td><input type="checkbox"/></td><td>7" x 9" 0.054" (1.37mm) 50 ksi (340 MPa) Gusset Plate w/ S/HD15S Simpson</td></tr> <tr><td><input checked="" type="checkbox"/></td><td>8" x 8" 0.068" (1.73mm) 50 ksi (340 MPa) Gusset Plate w/ S/HD15S Simpson</td></tr> <tr><td><input type="checkbox"/></td><td>8.5" x10" 0.068" (1.73mm) 50 ksi (340 MPa) Gusset Plate w/ S/HD15S Simpson</td></tr> <tr><td><input type="checkbox"/></td><td>10" x10" 0.054" (1.37mm) 50 ksi (340 MPa) Gusset Plate w/ S/HD15S Simpson</td></tr> </table>				<input type="checkbox"/>	S/HD10S Simpson	<input type="checkbox"/>	Fabricated U-shape	<input type="checkbox"/>	6" x 6" 0.054" (1.37mm) 50 ksi (340 MPa) Gusset Plate w/ S/HD15S Simpson	<input type="checkbox"/>	7" x 9" 0.054" (1.37mm) 50 ksi (340 MPa) Gusset Plate w/ S/HD15S Simpson	<input checked="" type="checkbox"/>	8" x 8" 0.068" (1.73mm) 50 ksi (340 MPa) Gusset Plate w/ S/HD15S Simpson	<input type="checkbox"/>	8.5" x10" 0.068" (1.73mm) 50 ksi (340 MPa) Gusset Plate w/ S/HD15S Simpson	<input type="checkbox"/>	10" x10" 0.054" (1.37mm) 50 ksi (340 MPa) Gusset Plate w/ S/HD15S Simpson														
<input type="checkbox"/>	S/HD10S Simpson																															
<input type="checkbox"/>	Fabricated U-shape																															
<input type="checkbox"/>	6" x 6" 0.054" (1.37mm) 50 ksi (340 MPa) Gusset Plate w/ S/HD15S Simpson																															
<input type="checkbox"/>	7" x 9" 0.054" (1.37mm) 50 ksi (340 MPa) Gusset Plate w/ S/HD15S Simpson																															
<input checked="" type="checkbox"/>	8" x 8" 0.068" (1.73mm) 50 ksi (340 MPa) Gusset Plate w/ S/HD15S Simpson																															
<input type="checkbox"/>	8.5" x10" 0.068" (1.73mm) 50 ksi (340 MPa) Gusset Plate w/ S/HD15S Simpson																															
<input type="checkbox"/>	10" x10" 0.054" (1.37mm) 50 ksi (340 MPa) Gusset Plate w/ S/HD15S Simpson																															
TEST PROTOCOL AND DESCRIPTION:	<table border="1" style="width:100%; border-collapse: collapse;"> <tr><td><input checked="" type="checkbox"/></td><td>Monotonic (Rate of Loading 2.5 mm/min)</td></tr> <tr><td><input type="checkbox"/></td><td>Cyclic (CUREE cyclic protocol)</td></tr> </table>				<input checked="" type="checkbox"/>	Monotonic (Rate of Loading 2.5 mm/min)	<input type="checkbox"/>	Cyclic (CUREE cyclic protocol)																								
<input checked="" type="checkbox"/>	Monotonic (Rate of Loading 2.5 mm/min)																															
<input type="checkbox"/>	Cyclic (CUREE cyclic protocol)																															
LVDT MEASUREMENTS:	<table border="1" style="width:100%; border-collapse: collapse;"> <tr><td><input checked="" type="checkbox"/></td><td>Actuator LVDT</td></tr> <tr><td><input checked="" type="checkbox"/></td><td>North Slip</td></tr> <tr><td><input checked="" type="checkbox"/></td><td>South Slip</td></tr> </table>		<input checked="" type="checkbox"/>	Actuator LVDT	<input checked="" type="checkbox"/>	North Slip	<input checked="" type="checkbox"/>	South Slip	<table border="1" style="width:100%; border-collapse: collapse;"> <tr><td><input checked="" type="checkbox"/></td><td>North Uplift</td></tr> <tr><td><input checked="" type="checkbox"/></td><td>South Uplift</td></tr> <tr><td><input checked="" type="checkbox"/></td><td>Top of Wall</td></tr> </table>		<input checked="" type="checkbox"/>	North Uplift	<input checked="" type="checkbox"/>	South Uplift	<input checked="" type="checkbox"/>	Top of Wall																
<input checked="" type="checkbox"/>	Actuator LVDT																															
<input checked="" type="checkbox"/>	North Slip																															
<input checked="" type="checkbox"/>	South Slip																															
<input checked="" type="checkbox"/>	North Uplift																															
<input checked="" type="checkbox"/>	South Uplift																															
<input checked="" type="checkbox"/>	Top of Wall																															
				TOTAL:	6																											
STRAP WIDTH BEFORE TEST:	<table border="1" style="width:100%; border-collapse: collapse;"> <tr> <td>Front Right, mm</td> <td>Front Left, mm</td> <td>Back Right, mm</td> <td>Back Left, mm</td> </tr> <tr> <td>100.22</td> <td>102.32</td> <td>101.37</td> <td>101.61</td> </tr> <tr> <td>100.81</td> <td>102.42</td> <td>101.36</td> <td>101.21</td> </tr> <tr> <td>102.54</td> <td>102.66</td> <td>102.24</td> <td>101.80</td> </tr> <tr> <td>AVG</td> <td>101.19 mm</td> <td>AVG</td> <td>102.47 mm</td> </tr> <tr> <td></td> <td></td> <td>AVG</td> <td>101.66 mm</td> </tr> <tr> <td></td> <td></td> <td>AVG</td> <td>101.54 mm</td> </tr> </table>				Front Right, mm	Front Left, mm	Back Right, mm	Back Left, mm	100.22	102.32	101.37	101.61	100.81	102.42	101.36	101.21	102.54	102.66	102.24	101.80	AVG	101.19 mm	AVG	102.47 mm			AVG	101.66 mm			AVG	101.54 mm
Front Right, mm	Front Left, mm	Back Right, mm	Back Left, mm																													
100.22	102.32	101.37	101.61																													
100.81	102.42	101.36	101.21																													
102.54	102.66	102.24	101.80																													
AVG	101.19 mm	AVG	102.47 mm																													
		AVG	101.66 mm																													
		AVG	101.54 mm																													
DATA ACQ. RECORD RATE:	1 scan/sec		MONITOR RATE:	10 scan/sec																												
COMMENTS:	<p>-Shear anchors torqued for 10 s with impact wrench *Front right and Back Left strap width are from Specimen 21A-M retest. The results are based on the retest.</p> <p>-Hold down anchors 1/2 turn from finger tight (load cells used on both hold-downs)</p> <p>-Double chord studs used screwed back to back</p> <p>* Square plate washers (2.5"x2.5") used in all top track connections</p> <p>-Regular washers used in all bottom track connections</p>																															

Figure E.13: Data sheet for test 21A-M

Cold Formed Steel Strap Braced Walls			
McGill University, Montreal			
TEST:		21A-M Retest	
RESEARCHER:		Gilles Comeau	
ASSISTANTS:		Kostadin Velchev, Nisreen Bah	
DATE:		8-Aug-07	
TIME:		2:00PM	
DIMENSIONS OF WALL:		8 FT X 8 FT X 6 IN.	
INITIAL STRAP SURVEY:		Front	Right
		Back	Left
			-
			Tight
STRAP FASTENER CONFIGURATION: MFR: McGill			
STRAP SIZE:	<input type="checkbox"/>	2.5" 0.043" (1.09mm) 33 ksi (230 MPa)	
	<input checked="" type="checkbox"/>	2.75" 0.054" (1.37mm) 50 ksi (340 MPa)	
	<input type="checkbox"/>	4" 0.068" (1.73mm) 50 ksi (340 MPa)	
	<input type="checkbox"/>	5" 0.043" (1.09) 33 ksi (230 MPa)	
	<input type="checkbox"/>	Reduced section strap -- fuse = 2.5" wide x 30" long -- ends = 3.75" wide 0.043" (1.09mm) 33 ksi (230 MPa)	
	<input type="checkbox"/>	Reduced section strap -- fuse = 2.75" wide x 30" long -- ends = 4.25" wide 0.054" (1.37mm) 50 ksi (340 MPa)	
	<input type="checkbox"/>	Reduced section strap -- fuse = 4" wide x 30" long -- ends = 6" wide 0.068" (1.73mm) 50 ksi (340 MPa)	
	<input type="checkbox"/>	Reduced section strap -- fuse = 2.5" wide x 60" long -- ends = 3.75" wide 0.043" (1.09mm) 33 ksi (230 MPa)	
	<input type="checkbox"/>	Reduced section strap -- fuse = 4" wide x 60" long -- ends = 6" wide 0.068" (1.73mm) 50 ksi (340 MPa)	
INTERIOR STUDS:	<input type="checkbox"/>	3-5/8"Wx1-5/8"Fx1/2"Lip 0.043" (1.09mm) 33ksi (230 Mpa)	STUD SPACING: <input checked="" type="checkbox"/> 16" O.C.
	<input checked="" type="checkbox"/>	6"Wx1-5/8"Fx1/2"Lip 0.043" (1.09mm) 33ksi (230 Mpa)	Other : _____
BACK-TO-BACK CHORD STUDS:	<input type="checkbox"/>	3-5/8"Wx1-5/8"Fx1/2"Lip 0.043" (1.09mm) 33ksi (230 Mpa)	
	<input type="checkbox"/>	6"Wx1-5/8"Fx1/2"Lip 0.054" (1.37mm) 50ksi (345 Mpa)	
	<input checked="" type="checkbox"/>	6"Wx1-5/8"Fx1/2"Lip 0.068" (1.73mm) 50ksi (345 Mpa)	
CONNECTIONS:	<input checked="" type="checkbox"/>	No.10 gauge 0.75" self-drilling wafer head (mod. Truss) Phillips drive	
	<input checked="" type="checkbox"/>	No.8 gauge 0.5" self-drilling wafer head (mod. Truss) Phillips drive	
	<input checked="" type="checkbox"/>	No.14 gauge 1" self-drilling Hex washer head	
	<input checked="" type="checkbox"/>	No.10 gauge 0.75" self-drilling Hex washer head	
	<input type="checkbox"/>	7/8" A193 Rod	
	<input checked="" type="checkbox"/>	1" A193 Rod	
	<input checked="" type="checkbox"/>	A325 3/4" bolts	10 bolts <input checked="" type="checkbox"/>
	<input checked="" type="checkbox"/>	A325 3/4" bolts	6 bolts <input checked="" type="checkbox"/>
			2 Anchor Rods <input checked="" type="checkbox"/>
			2 Anchor Rods <input checked="" type="checkbox"/>
TRACK:	<input checked="" type="checkbox"/>	Regular	<input checked="" type="checkbox"/> 6" web
	<input type="checkbox"/>	Extended	<input type="checkbox"/> 3 5/8" web
	<input type="checkbox"/>	Reinforced	<input type="checkbox"/> 1-1/4" flange
	<input type="checkbox"/>		<input type="checkbox"/> 0.043" (1.09mm) 33ksi (230 Mpa)
	<input type="checkbox"/>		<input type="checkbox"/> 0.054" (1.37mm) 50ksi (345 Mpa)
	<input type="checkbox"/>		<input type="checkbox"/> 0.068" (1.73mm) 50ksi (345 Mpa)
	<input checked="" type="checkbox"/>		<input checked="" type="checkbox"/> 0.097" (1.73mm) 50ksi (345 Mpa)
HOLD DOWNS:	<input type="checkbox"/>	S/HD10S Simpson	
	<input type="checkbox"/>	Fabricated U-shape	
	<input type="checkbox"/>	6" x 6" 0.054" (1.37mm) 50 ksi (340 MPa) Gusset Plate w/ S/HD15S Simpson	
	<input type="checkbox"/>	7" x 9" 0.054" (1.37mm) 50 ksi (340 MPa) Gusset Plate w/ S/HD15S Simpson	
	<input checked="" type="checkbox"/>	8" x 8" 0.068" (1.73mm) 50 ksi (340 MPa) Gusset Plate w/ S/HD15S Simpson	
	<input type="checkbox"/>	8.5" x10" 0.068" (1.73mm) 50 ksi (340 MPa) Gusset Plate w/ S/HD15S Simpson	
	<input type="checkbox"/>	10" x10" 0.054" (1.37mm) 50 ksi (340 MPa) Gusset Plate w/ S/HD15S Simpson	
TEST PROTOCOL AND DESCRIPTION:	<input checked="" type="checkbox"/>	Monotonic (Rate of Loading 2.5 mm/min)	
	<input type="checkbox"/>	Cyclic (CUREE cyclic protocol)	
LVDT MEASUREMENTS:	<input checked="" type="checkbox"/>	Actuator LVDT	<input checked="" type="checkbox"/> North Uplift
	<input checked="" type="checkbox"/>	North Slip	<input checked="" type="checkbox"/> South Uplift
	<input checked="" type="checkbox"/>	South Slip	<input checked="" type="checkbox"/> Top of Wall
			TOTAL: <input type="text" value="6"/>
STRAP WIDTH BEFORE TEST:	Front Right	Front Left, mm	Back Right, mm
	100.22		
	100.81		
	102.54		
	AVG	101.19 mm	AVG
			AVG
			AVG
			AVG
			101.61
			101.21
			101.80
			AVG
			101.54 mm
DATA ACQ. RECORD RATE:	1 scan/sec		MONITOR RATE: 10 scan/sec
COMMENTS:	-Shear anchors torqued for 10 s with impact wrench -Hold down anchors 1/2 turn from finger tight (load cells used on both hold-downs) -Double chord studs used screwed back to back -Square plate washers (2.5"x2.5") used in all top track connections -Regular washers used in all bottom track connections		

Figure E.15: Data sheet for test 21A-M Retest



McGill

Cold Formed Steel Frame Strap Braced Shear Wall Testing

Test name : 21A-M Retest
 Date tested : August 8, 2007
 Wall Size : 8' x 9'
 Strap Size : 4"
 Extended Track : yes no
 Holddown : Inside Outside
 Test mode : Cyclic Monotonic

Front side notes: _____

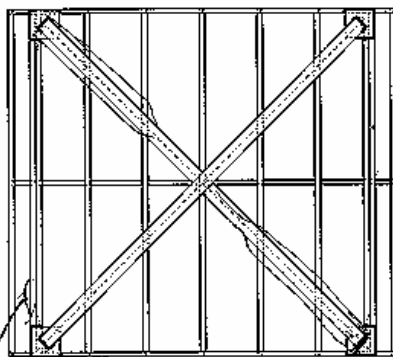

Front

S S

Back side notes: _____

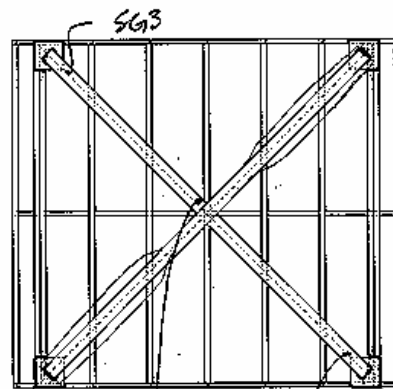

SG5 Back

SG4

N

General notes:

- Wall frame from 22A-C
- 29A-M Retest run in pull direction (screwed straps to face)
- Some initial damage to flexion stud from other tests
- Note: SG positions
- No screws through straps
- Yield Load = 92.6 kN, $\Delta = 41$ mm
- No weld failures, chord stud failure in compression at end of test.

Figure E.16: Observations for test 21A-M Retest

Cold Formed Steel Strap Braced Walls McGill University, Montreal																																						
TEST:		23A-M																																				
RESEARCHER:	Gilles Comeau	ASSISTANTS:	Kostadin Velchev, Nisreen Bah																																			
DATE:	10-Jul-07	TIME:	1:30PM																																			
DIMENSIONS OF WALL:	8 FT X 8 FT X 6 IN.	INITIAL STRAP SURVEY:	<table style="font-size: small;"> <tr><td>Front</td><td>Right</td><td>Left</td></tr> <tr><td>Back</td><td>Tight</td><td>Tight</td></tr> <tr><td></td><td>Tight</td><td>Tight</td></tr> </table>	Front	Right	Left	Back	Tight	Tight		Tight	Tight																										
Front	Right	Left																																				
Back	Tight	Tight																																				
	Tight	Tight																																				
STRAP FASTENER CONFIGURATION: MFR: McGill																																						
STRAP SIZE:	<table style="font-size: small;"> <tr><td><input type="checkbox"/></td><td>2.5" 0.043" (1.09mm) 33 ksi (230 MPa)</td></tr> <tr><td><input type="checkbox"/></td><td>2.75" 0.054" (1.37mm) 50 ksi (340 MPa)</td></tr> <tr><td><input checked="" type="checkbox"/></td><td>4" 0.068" (1.73mm) 50 ksi (340 MPa)</td></tr> <tr><td><input type="checkbox"/></td><td>5" 0.043" (1.09) 33 ksi (230 MPa)</td></tr> <tr><td><input type="checkbox"/></td><td>Reduced section strap -- fuse = 2.5" wide x 30" long -- ends = 3.75" wide 0.043" (1.09mm) 33 ksi (230 MPa)</td></tr> <tr><td><input type="checkbox"/></td><td>Reduced section strap -- fuse = 2.75" wide x 30" long -- ends = 4.25" wide 0.054" (1.37mm) 50 ksi (340 MPa)</td></tr> <tr><td><input type="checkbox"/></td><td>Reduced section strap -- fuse = 4" wide x 30" long -- ends = 6" wide 0.068" (1.73mm) 50 ksi (340 MPa)</td></tr> <tr><td><input type="checkbox"/></td><td>Reduced section strap -- fuse = 2.5" wide x 60" long -- ends = 3.75" wide 0.043" (1.09mm) 33 ksi (230 MPa)</td></tr> <tr><td><input type="checkbox"/></td><td>Reduced section strap -- fuse = 4" wide x 60" long -- ends = 6" wide 0.068" (1.73mm) 50 ksi (340 MPa)</td></tr> </table>			<input type="checkbox"/>	2.5" 0.043" (1.09mm) 33 ksi (230 MPa)	<input type="checkbox"/>	2.75" 0.054" (1.37mm) 50 ksi (340 MPa)	<input checked="" type="checkbox"/>	4" 0.068" (1.73mm) 50 ksi (340 MPa)	<input type="checkbox"/>	5" 0.043" (1.09) 33 ksi (230 MPa)	<input type="checkbox"/>	Reduced section strap -- fuse = 2.5" wide x 30" long -- ends = 3.75" wide 0.043" (1.09mm) 33 ksi (230 MPa)	<input type="checkbox"/>	Reduced section strap -- fuse = 2.75" wide x 30" long -- ends = 4.25" wide 0.054" (1.37mm) 50 ksi (340 MPa)	<input type="checkbox"/>	Reduced section strap -- fuse = 4" wide x 30" long -- ends = 6" wide 0.068" (1.73mm) 50 ksi (340 MPa)	<input type="checkbox"/>	Reduced section strap -- fuse = 2.5" wide x 60" long -- ends = 3.75" wide 0.043" (1.09mm) 33 ksi (230 MPa)	<input type="checkbox"/>	Reduced section strap -- fuse = 4" wide x 60" long -- ends = 6" wide 0.068" (1.73mm) 50 ksi (340 MPa)																	
<input type="checkbox"/>	2.5" 0.043" (1.09mm) 33 ksi (230 MPa)																																					
<input type="checkbox"/>	2.75" 0.054" (1.37mm) 50 ksi (340 MPa)																																					
<input checked="" type="checkbox"/>	4" 0.068" (1.73mm) 50 ksi (340 MPa)																																					
<input type="checkbox"/>	5" 0.043" (1.09) 33 ksi (230 MPa)																																					
<input type="checkbox"/>	Reduced section strap -- fuse = 2.5" wide x 30" long -- ends = 3.75" wide 0.043" (1.09mm) 33 ksi (230 MPa)																																					
<input type="checkbox"/>	Reduced section strap -- fuse = 2.75" wide x 30" long -- ends = 4.25" wide 0.054" (1.37mm) 50 ksi (340 MPa)																																					
<input type="checkbox"/>	Reduced section strap -- fuse = 4" wide x 30" long -- ends = 6" wide 0.068" (1.73mm) 50 ksi (340 MPa)																																					
<input type="checkbox"/>	Reduced section strap -- fuse = 2.5" wide x 60" long -- ends = 3.75" wide 0.043" (1.09mm) 33 ksi (230 MPa)																																					
<input type="checkbox"/>	Reduced section strap -- fuse = 4" wide x 60" long -- ends = 6" wide 0.068" (1.73mm) 50 ksi (340 MPa)																																					
INTERIOR STUDS:	<table style="font-size: small;"> <tr><td><input type="checkbox"/></td><td>3-5/8"Wx1-5/8"Fx1/2"Lip 0.043" (1.09mm) 33ksi (230 Mpa)</td></tr> <tr><td><input checked="" type="checkbox"/></td><td>6"Wx1-5/8"Fx1/2"Lip 0.043" (1.09mm) 33ksi (230 Mpa)</td></tr> </table>	<input type="checkbox"/>	3-5/8"Wx1-5/8"Fx1/2"Lip 0.043" (1.09mm) 33ksi (230 Mpa)	<input checked="" type="checkbox"/>	6"Wx1-5/8"Fx1/2"Lip 0.043" (1.09mm) 33ksi (230 Mpa)	STUD SPACING:	<table style="font-size: small;"> <tr><td><input checked="" type="checkbox"/></td><td>16" O.C.</td></tr> <tr><td><input type="checkbox"/></td><td>Other :</td></tr> </table>	<input checked="" type="checkbox"/>	16" O.C.	<input type="checkbox"/>	Other :																											
<input type="checkbox"/>	3-5/8"Wx1-5/8"Fx1/2"Lip 0.043" (1.09mm) 33ksi (230 Mpa)																																					
<input checked="" type="checkbox"/>	6"Wx1-5/8"Fx1/2"Lip 0.043" (1.09mm) 33ksi (230 Mpa)																																					
<input checked="" type="checkbox"/>	16" O.C.																																					
<input type="checkbox"/>	Other :																																					
BACK-TO-BACK CHORD STUDS:	<table style="font-size: small;"> <tr><td><input type="checkbox"/></td><td>3-5/8"Wx1-5/8"Fx1/2"Lip 0.043" (1.09mm) 33ksi (230 Mpa)</td></tr> <tr><td><input type="checkbox"/></td><td>6"Wx1-5/8"Fx1/2"Lip 0.054" (1.37mm) 50ksi (345 Mpa)</td></tr> <tr><td><input checked="" type="checkbox"/></td><td>6"Wx1-5/8"Fx1/2"Lip 0.068" (1.73mm) 50ksi (345 Mpa)</td></tr> </table>			<input type="checkbox"/>	3-5/8"Wx1-5/8"Fx1/2"Lip 0.043" (1.09mm) 33ksi (230 Mpa)	<input type="checkbox"/>	6"Wx1-5/8"Fx1/2"Lip 0.054" (1.37mm) 50ksi (345 Mpa)	<input checked="" type="checkbox"/>	6"Wx1-5/8"Fx1/2"Lip 0.068" (1.73mm) 50ksi (345 Mpa)																													
<input type="checkbox"/>	3-5/8"Wx1-5/8"Fx1/2"Lip 0.043" (1.09mm) 33ksi (230 Mpa)																																					
<input type="checkbox"/>	6"Wx1-5/8"Fx1/2"Lip 0.054" (1.37mm) 50ksi (345 Mpa)																																					
<input checked="" type="checkbox"/>	6"Wx1-5/8"Fx1/2"Lip 0.068" (1.73mm) 50ksi (345 Mpa)																																					
CONNECTIONS:	<table style="font-size: small;"> <tr><td><input checked="" type="checkbox"/></td><td>No.10 gauge 0.75" self-drilling wafer head (mod. Truss) Phillips drive</td></tr> <tr><td><input checked="" type="checkbox"/></td><td>No.8 gauge 0.5" self-drilling wafer head (mod. Truss) Phillips drive</td></tr> <tr><td><input checked="" type="checkbox"/></td><td>No.14 gauge 1" self-drilling Hex washer head</td></tr> <tr><td><input checked="" type="checkbox"/></td><td>No.10 gauge 0.75" self-drilling Hex washer head</td></tr> <tr><td><input type="checkbox"/></td><td>7/8" A193 Rod</td></tr> <tr><td><input checked="" type="checkbox"/></td><td>1" A193 Rod</td></tr> <tr><td><input checked="" type="checkbox"/></td><td>A325 3/4" bolts</td></tr> <tr><td><input checked="" type="checkbox"/></td><td>A325 3/4" bolts</td></tr> </table>			<input checked="" type="checkbox"/>	No.10 gauge 0.75" self-drilling wafer head (mod. Truss) Phillips drive	<input checked="" type="checkbox"/>	No.8 gauge 0.5" self-drilling wafer head (mod. Truss) Phillips drive	<input checked="" type="checkbox"/>	No.14 gauge 1" self-drilling Hex washer head	<input checked="" type="checkbox"/>	No.10 gauge 0.75" self-drilling Hex washer head	<input type="checkbox"/>	7/8" A193 Rod	<input checked="" type="checkbox"/>	1" A193 Rod	<input checked="" type="checkbox"/>	A325 3/4" bolts	<input checked="" type="checkbox"/>	A325 3/4" bolts																			
<input checked="" type="checkbox"/>	No.10 gauge 0.75" self-drilling wafer head (mod. Truss) Phillips drive																																					
<input checked="" type="checkbox"/>	No.8 gauge 0.5" self-drilling wafer head (mod. Truss) Phillips drive																																					
<input checked="" type="checkbox"/>	No.14 gauge 1" self-drilling Hex washer head																																					
<input checked="" type="checkbox"/>	No.10 gauge 0.75" self-drilling Hex washer head																																					
<input type="checkbox"/>	7/8" A193 Rod																																					
<input checked="" type="checkbox"/>	1" A193 Rod																																					
<input checked="" type="checkbox"/>	A325 3/4" bolts																																					
<input checked="" type="checkbox"/>	A325 3/4" bolts																																					
TRACK:	<table style="font-size: small;"> <tr><td><input checked="" type="checkbox"/></td><td>Regular</td><td><input checked="" type="checkbox"/></td><td>6" web</td></tr> <tr><td><input type="checkbox"/></td><td>Extended</td><td><input type="checkbox"/></td><td>3 5/8" web</td></tr> <tr><td><input type="checkbox"/></td><td>Reinforced</td><td><input type="checkbox"/></td><td>1-1/4" flange</td></tr> </table>	<input checked="" type="checkbox"/>	Regular	<input checked="" type="checkbox"/>	6" web	<input type="checkbox"/>	Extended	<input type="checkbox"/>	3 5/8" web	<input type="checkbox"/>	Reinforced	<input type="checkbox"/>	1-1/4" flange	<table style="font-size: small;"> <tr><td><input type="checkbox"/></td><td>0.043" (1.09mm) 33ksi (230 Mpa)</td></tr> <tr><td><input type="checkbox"/></td><td>0.054" (1.37mm) 50ksi (345 Mpa)</td></tr> <tr><td><input type="checkbox"/></td><td>0.068" (1.73mm) 50ksi (345 Mpa)</td></tr> <tr><td><input checked="" type="checkbox"/></td><td>0.097" (1.73mm) 50ksi (345 Mpa)</td></tr> </table>	<input type="checkbox"/>	0.043" (1.09mm) 33ksi (230 Mpa)	<input type="checkbox"/>	0.054" (1.37mm) 50ksi (345 Mpa)	<input type="checkbox"/>	0.068" (1.73mm) 50ksi (345 Mpa)	<input checked="" type="checkbox"/>	0.097" (1.73mm) 50ksi (345 Mpa)	<table style="font-size: small;"> <tr><td>10 bolts</td><td><input checked="" type="checkbox"/></td><td>2 Anchor Rods</td><td><input checked="" type="checkbox"/></td></tr> <tr><td>6 bolts</td><td><input checked="" type="checkbox"/></td><td>2 Anchor Rods</td><td><input checked="" type="checkbox"/></td></tr> </table>	10 bolts	<input checked="" type="checkbox"/>	2 Anchor Rods	<input checked="" type="checkbox"/>	6 bolts	<input checked="" type="checkbox"/>	2 Anchor Rods	<input checked="" type="checkbox"/>							
<input checked="" type="checkbox"/>	Regular	<input checked="" type="checkbox"/>	6" web																																			
<input type="checkbox"/>	Extended	<input type="checkbox"/>	3 5/8" web																																			
<input type="checkbox"/>	Reinforced	<input type="checkbox"/>	1-1/4" flange																																			
<input type="checkbox"/>	0.043" (1.09mm) 33ksi (230 Mpa)																																					
<input type="checkbox"/>	0.054" (1.37mm) 50ksi (345 Mpa)																																					
<input type="checkbox"/>	0.068" (1.73mm) 50ksi (345 Mpa)																																					
<input checked="" type="checkbox"/>	0.097" (1.73mm) 50ksi (345 Mpa)																																					
10 bolts	<input checked="" type="checkbox"/>	2 Anchor Rods	<input checked="" type="checkbox"/>																																			
6 bolts	<input checked="" type="checkbox"/>	2 Anchor Rods	<input checked="" type="checkbox"/>																																			
HOLD DOWNS:	<table style="font-size: small;"> <tr><td><input type="checkbox"/></td><td>S/HD10S Simpson</td><td>inside</td><td>outside</td><td>raised</td></tr> <tr><td><input type="checkbox"/></td><td>Fabricated U-shape</td><td></td><td></td><td></td></tr> <tr><td><input type="checkbox"/></td><td>6" x 6" 0.054" (1.37mm) 50 ksi (340 MPa) Gusset Plate w/ S/HD15S Simpson</td><td></td><td></td><td></td></tr> <tr><td><input type="checkbox"/></td><td>7" x 9" 0.054" (1.37mm) 50 ksi (340 MPa) Gusset Plate w/ S/HD15S Simpson</td><td></td><td></td><td></td></tr> <tr><td><input checked="" type="checkbox"/></td><td>8" x 8" 0.068" (1.73mm) 50 ksi (340 MPa) Gusset Plate w/ S/HD15S Simpson</td><td><input checked="" type="checkbox"/></td><td></td><td></td></tr> <tr><td><input type="checkbox"/></td><td>8.5" x10" 0.068" (1.73mm) 50 ksi (340 MPa) Gusset Plate w/ S/HD15S Simpson</td><td></td><td></td><td></td></tr> <tr><td><input type="checkbox"/></td><td>10" x10" 0.054" (1.37mm) 50 ksi (340 MPa) Gusset Plate w/ S/HD15S Simpson</td><td></td><td></td><td></td></tr> </table>			<input type="checkbox"/>	S/HD10S Simpson	inside	outside	raised	<input type="checkbox"/>	Fabricated U-shape				<input type="checkbox"/>	6" x 6" 0.054" (1.37mm) 50 ksi (340 MPa) Gusset Plate w/ S/HD15S Simpson				<input type="checkbox"/>	7" x 9" 0.054" (1.37mm) 50 ksi (340 MPa) Gusset Plate w/ S/HD15S Simpson				<input checked="" type="checkbox"/>	8" x 8" 0.068" (1.73mm) 50 ksi (340 MPa) Gusset Plate w/ S/HD15S Simpson	<input checked="" type="checkbox"/>			<input type="checkbox"/>	8.5" x10" 0.068" (1.73mm) 50 ksi (340 MPa) Gusset Plate w/ S/HD15S Simpson				<input type="checkbox"/>	10" x10" 0.054" (1.37mm) 50 ksi (340 MPa) Gusset Plate w/ S/HD15S Simpson			
<input type="checkbox"/>	S/HD10S Simpson	inside	outside	raised																																		
<input type="checkbox"/>	Fabricated U-shape																																					
<input type="checkbox"/>	6" x 6" 0.054" (1.37mm) 50 ksi (340 MPa) Gusset Plate w/ S/HD15S Simpson																																					
<input type="checkbox"/>	7" x 9" 0.054" (1.37mm) 50 ksi (340 MPa) Gusset Plate w/ S/HD15S Simpson																																					
<input checked="" type="checkbox"/>	8" x 8" 0.068" (1.73mm) 50 ksi (340 MPa) Gusset Plate w/ S/HD15S Simpson	<input checked="" type="checkbox"/>																																				
<input type="checkbox"/>	8.5" x10" 0.068" (1.73mm) 50 ksi (340 MPa) Gusset Plate w/ S/HD15S Simpson																																					
<input type="checkbox"/>	10" x10" 0.054" (1.37mm) 50 ksi (340 MPa) Gusset Plate w/ S/HD15S Simpson																																					
TEST PROTOCOL AND DESCRIPTION:	<table style="font-size: small;"> <tr><td><input checked="" type="checkbox"/></td><td>Monotonic (Rate of Loading 2.5 mm/min)</td></tr> <tr><td><input type="checkbox"/></td><td>Cyclic (CUREE cyclic protocol)</td></tr> </table>			<input checked="" type="checkbox"/>	Monotonic (Rate of Loading 2.5 mm/min)	<input type="checkbox"/>	Cyclic (CUREE cyclic protocol)																															
<input checked="" type="checkbox"/>	Monotonic (Rate of Loading 2.5 mm/min)																																					
<input type="checkbox"/>	Cyclic (CUREE cyclic protocol)																																					
LVDT MEASUREMENTS:	<table style="font-size: small;"> <tr><td><input checked="" type="checkbox"/></td><td>Actuator LVDT</td><td><input checked="" type="checkbox"/></td><td>North Uplift</td></tr> <tr><td><input checked="" type="checkbox"/></td><td>North Slip</td><td><input checked="" type="checkbox"/></td><td>South Uplift</td></tr> <tr><td><input checked="" type="checkbox"/></td><td>South Slip</td><td><input checked="" type="checkbox"/></td><td>Top of Wall</td></tr> </table>	<input checked="" type="checkbox"/>	Actuator LVDT	<input checked="" type="checkbox"/>	North Uplift	<input checked="" type="checkbox"/>	North Slip	<input checked="" type="checkbox"/>	South Uplift	<input checked="" type="checkbox"/>	South Slip	<input checked="" type="checkbox"/>	Top of Wall	TOTAL: <input type="text" value="6"/>																								
<input checked="" type="checkbox"/>	Actuator LVDT	<input checked="" type="checkbox"/>	North Uplift																																			
<input checked="" type="checkbox"/>	North Slip	<input checked="" type="checkbox"/>	South Uplift																																			
<input checked="" type="checkbox"/>	South Slip	<input checked="" type="checkbox"/>	Top of Wall																																			
STRAP WIDTH BEFORE TEST:	<table style="font-size: small; width: 100%;"> <tr> <td style="width: 25%;">Front Right</td> <td style="width: 25%;">Front Left, mm</td> <td style="width: 25%;">Back Right, mm</td> <td style="width: 25%;">Back Left, mm</td> </tr> <tr> <td><input type="text" value="102.3"/></td> <td><input type="text" value="102.56"/></td> <td><input type="text" value="102.59"/></td> <td><input type="text" value="102.54"/></td> </tr> <tr> <td><input type="text" value="102.31"/></td> <td><input type="text" value="102.24"/></td> <td><input type="text" value="102.38"/></td> <td><input type="text" value="101.18"/></td> </tr> <tr> <td><input type="text" value="102.55"/></td> <td><input type="text" value="102.91"/></td> <td><input type="text" value="102.36"/></td> <td><input type="text" value="101.15"/></td> </tr> <tr> <td>AVG <input type="text" value="102.39"/> mm</td> <td>AVG <input type="text" value="102.57"/> mm</td> <td>AVG <input type="text" value="102.44"/> mm</td> <td>AVG <input type="text" value="101.62"/> mm</td> </tr> </table>				Front Right	Front Left, mm	Back Right, mm	Back Left, mm	<input type="text" value="102.3"/>	<input type="text" value="102.56"/>	<input type="text" value="102.59"/>	<input type="text" value="102.54"/>	<input type="text" value="102.31"/>	<input type="text" value="102.24"/>	<input type="text" value="102.38"/>	<input type="text" value="101.18"/>	<input type="text" value="102.55"/>	<input type="text" value="102.91"/>	<input type="text" value="102.36"/>	<input type="text" value="101.15"/>	AVG <input type="text" value="102.39"/> mm	AVG <input type="text" value="102.57"/> mm	AVG <input type="text" value="102.44"/> mm	AVG <input type="text" value="101.62"/> mm														
Front Right	Front Left, mm	Back Right, mm	Back Left, mm																																			
<input type="text" value="102.3"/>	<input type="text" value="102.56"/>	<input type="text" value="102.59"/>	<input type="text" value="102.54"/>																																			
<input type="text" value="102.31"/>	<input type="text" value="102.24"/>	<input type="text" value="102.38"/>	<input type="text" value="101.18"/>																																			
<input type="text" value="102.55"/>	<input type="text" value="102.91"/>	<input type="text" value="102.36"/>	<input type="text" value="101.15"/>																																			
AVG <input type="text" value="102.39"/> mm	AVG <input type="text" value="102.57"/> mm	AVG <input type="text" value="102.44"/> mm	AVG <input type="text" value="101.62"/> mm																																			
DATA ACQ. RECORD RATE:	1 scan/sec		MONITOR RATE:	10 scan/sec																																		
COMMENTS:	<ul style="list-style-type: none"> -Shear anchors torqued for 10 s with impact wrench -Hold down anchors 1/2 turn from finger tight (load cells used on both hold-downs) -Double chord studs used screwed back to back -Square plate washers (2.5"x2.5") used in all top track connections -Regular washers used in all bottom track connections 																																					

Figure E.17: Data sheet for test 23A-M

Cold Formed Steel Strap Braced Walls McGill University, Montreal																															
TEST:		23B-M																													
RESEARCHER:	Gilles Comeau		ASSISTANTS:																												
		Kostadin Velchev, Nisreen Bah																													
DATE:	16-Jul-07		TIME:																												
		2:30PM																													
DIMENSIONS OF WALL:	4 FT X	8 FT X	6 IN.																												
INITIAL STRAP SURVEY:	Front	Right	Left																												
	Back	Tight	Tight																												
		Tight	Tight																												
STRAP FASTENER CONFIGURATION: MFR: McGill																															
STRAP SIZE:	<table border="1" style="width:100%; border-collapse: collapse;"> <tr><td><input type="checkbox"/></td><td>2.5" 0.043" (1.09mm) 33 ksi (230 MPa)</td></tr> <tr><td><input type="checkbox"/></td><td>2.75" 0.054" (1.37mm) 50 ksi (340 MPa)</td></tr> <tr><td><input checked="" type="checkbox"/></td><td>4" 0.068" (1.73mm) 50 ksi (340 MPa)</td></tr> <tr><td><input type="checkbox"/></td><td>5" 0.043" (1.09) 33 ksi (230 MPa)</td></tr> <tr><td><input type="checkbox"/></td><td>Reduced section strap -- fuse = 2.5" wide x 30" long -- ends = 3.75" wide 0.043" (1.09mm) 33 ksi (230 MPa)</td></tr> <tr><td><input type="checkbox"/></td><td>Reduced section strap -- fuse = 2.75" wide x 30" long -- ends = 4.25" wide 0.054" (1.37mm) 50 ksi (340 MPa)</td></tr> <tr><td><input type="checkbox"/></td><td>Reduced section strap -- fuse = 4" wide x 30" long -- ends = 6" wide 0.068" (1.73mm) 50 ksi (340 MPa)</td></tr> <tr><td><input type="checkbox"/></td><td>Reduced section strap -- fuse = 2.5" wide x 60" long -- ends = 3.75" wide 0.043" (1.09mm) 33 ksi (230 MPa)</td></tr> <tr><td><input type="checkbox"/></td><td>Reduced section strap -- fuse = 4" wide x 60" long -- ends = 6" wide 0.068" (1.73mm) 50 ksi (340 MPa)</td></tr> </table>			<input type="checkbox"/>	2.5" 0.043" (1.09mm) 33 ksi (230 MPa)	<input type="checkbox"/>	2.75" 0.054" (1.37mm) 50 ksi (340 MPa)	<input checked="" type="checkbox"/>	4" 0.068" (1.73mm) 50 ksi (340 MPa)	<input type="checkbox"/>	5" 0.043" (1.09) 33 ksi (230 MPa)	<input type="checkbox"/>	Reduced section strap -- fuse = 2.5" wide x 30" long -- ends = 3.75" wide 0.043" (1.09mm) 33 ksi (230 MPa)	<input type="checkbox"/>	Reduced section strap -- fuse = 2.75" wide x 30" long -- ends = 4.25" wide 0.054" (1.37mm) 50 ksi (340 MPa)	<input type="checkbox"/>	Reduced section strap -- fuse = 4" wide x 30" long -- ends = 6" wide 0.068" (1.73mm) 50 ksi (340 MPa)	<input type="checkbox"/>	Reduced section strap -- fuse = 2.5" wide x 60" long -- ends = 3.75" wide 0.043" (1.09mm) 33 ksi (230 MPa)	<input type="checkbox"/>	Reduced section strap -- fuse = 4" wide x 60" long -- ends = 6" wide 0.068" (1.73mm) 50 ksi (340 MPa)										
<input type="checkbox"/>	2.5" 0.043" (1.09mm) 33 ksi (230 MPa)																														
<input type="checkbox"/>	2.75" 0.054" (1.37mm) 50 ksi (340 MPa)																														
<input checked="" type="checkbox"/>	4" 0.068" (1.73mm) 50 ksi (340 MPa)																														
<input type="checkbox"/>	5" 0.043" (1.09) 33 ksi (230 MPa)																														
<input type="checkbox"/>	Reduced section strap -- fuse = 2.5" wide x 30" long -- ends = 3.75" wide 0.043" (1.09mm) 33 ksi (230 MPa)																														
<input type="checkbox"/>	Reduced section strap -- fuse = 2.75" wide x 30" long -- ends = 4.25" wide 0.054" (1.37mm) 50 ksi (340 MPa)																														
<input type="checkbox"/>	Reduced section strap -- fuse = 4" wide x 30" long -- ends = 6" wide 0.068" (1.73mm) 50 ksi (340 MPa)																														
<input type="checkbox"/>	Reduced section strap -- fuse = 2.5" wide x 60" long -- ends = 3.75" wide 0.043" (1.09mm) 33 ksi (230 MPa)																														
<input type="checkbox"/>	Reduced section strap -- fuse = 4" wide x 60" long -- ends = 6" wide 0.068" (1.73mm) 50 ksi (340 MPa)																														
INTERIOR STUDS:	<table border="1" style="width:100%; border-collapse: collapse;"> <tr><td><input type="checkbox"/></td><td>3-5/8"Wx1-5/8"Fx1/2"Lip 0.043" (1.09mm) 33ksi (230 Mpa)</td></tr> <tr><td><input checked="" type="checkbox"/></td><td>6"Wx1-5/8"Fx1/2"Lip 0.043" (1.09mm) 33ksi (230 Mpa)</td></tr> </table>		<input type="checkbox"/>	3-5/8"Wx1-5/8"Fx1/2"Lip 0.043" (1.09mm) 33ksi (230 Mpa)	<input checked="" type="checkbox"/>	6"Wx1-5/8"Fx1/2"Lip 0.043" (1.09mm) 33ksi (230 Mpa)	STUD SPACING:																								
<input type="checkbox"/>	3-5/8"Wx1-5/8"Fx1/2"Lip 0.043" (1.09mm) 33ksi (230 Mpa)																														
<input checked="" type="checkbox"/>	6"Wx1-5/8"Fx1/2"Lip 0.043" (1.09mm) 33ksi (230 Mpa)																														
		<input checked="" type="checkbox"/>	16" O.C.																												
		<input type="checkbox"/>	Other :																												
BACK-TO-BACK CHORD STUDS:	<table border="1" style="width:100%; border-collapse: collapse;"> <tr><td><input type="checkbox"/></td><td>3-5/8"Wx1-5/8"Fx1/2"Lip 0.043" (1.09mm) 33ksi (230 Mpa)</td></tr> <tr><td><input type="checkbox"/></td><td>6"Wx1-5/8"Fx1/2"Lip 0.054" (1.37mm) 50ksi (345 Mpa)</td></tr> <tr><td><input checked="" type="checkbox"/></td><td>6"Wx1-5/8"Fx1/2"Lip 0.068" (1.73mm) 50ksi (345 Mpa)</td></tr> </table>			<input type="checkbox"/>	3-5/8"Wx1-5/8"Fx1/2"Lip 0.043" (1.09mm) 33ksi (230 Mpa)	<input type="checkbox"/>	6"Wx1-5/8"Fx1/2"Lip 0.054" (1.37mm) 50ksi (345 Mpa)	<input checked="" type="checkbox"/>	6"Wx1-5/8"Fx1/2"Lip 0.068" (1.73mm) 50ksi (345 Mpa)																						
<input type="checkbox"/>	3-5/8"Wx1-5/8"Fx1/2"Lip 0.043" (1.09mm) 33ksi (230 Mpa)																														
<input type="checkbox"/>	6"Wx1-5/8"Fx1/2"Lip 0.054" (1.37mm) 50ksi (345 Mpa)																														
<input checked="" type="checkbox"/>	6"Wx1-5/8"Fx1/2"Lip 0.068" (1.73mm) 50ksi (345 Mpa)																														
CONNECTIONS:	<table border="1" style="width:100%; border-collapse: collapse;"> <tr><td><input checked="" type="checkbox"/></td><td>No.10 gauge 0.75" self-drilling wafer head (mod. Truss) Phillips drive</td></tr> <tr><td><input checked="" type="checkbox"/></td><td>Framing: No.8 gauge 0.5" self-drilling wafer head (mod. Truss) Phillips drive</td></tr> <tr><td><input checked="" type="checkbox"/></td><td>Hold downs: No.14 gauge1" self-drilling Hex washer head</td></tr> <tr><td><input type="checkbox"/></td><td>Back-to-Back</td></tr> <tr><td><input checked="" type="checkbox"/></td><td>Chord Studs: No.10 gauge 0.75" self-drilling Hex washer head</td></tr> <tr><td><input type="checkbox"/></td><td>Anchor Rods: 7/8" A193 Rod</td></tr> <tr><td><input checked="" type="checkbox"/></td><td>1" A193 Rod</td></tr> <tr><td><input checked="" type="checkbox"/></td><td>Loading Beam: A325 3/4" bolts</td></tr> <tr><td><input checked="" type="checkbox"/></td><td>Base: A325 3/4" bolts</td></tr> </table>			<input checked="" type="checkbox"/>	No.10 gauge 0.75" self-drilling wafer head (mod. Truss) Phillips drive	<input checked="" type="checkbox"/>	Framing: No.8 gauge 0.5" self-drilling wafer head (mod. Truss) Phillips drive	<input checked="" type="checkbox"/>	Hold downs: No.14 gauge1" self-drilling Hex washer head	<input type="checkbox"/>	Back-to-Back	<input checked="" type="checkbox"/>	Chord Studs: No.10 gauge 0.75" self-drilling Hex washer head	<input type="checkbox"/>	Anchor Rods: 7/8" A193 Rod	<input checked="" type="checkbox"/>	1" A193 Rod	<input checked="" type="checkbox"/>	Loading Beam: A325 3/4" bolts	<input checked="" type="checkbox"/>	Base: A325 3/4" bolts										
<input checked="" type="checkbox"/>	No.10 gauge 0.75" self-drilling wafer head (mod. Truss) Phillips drive																														
<input checked="" type="checkbox"/>	Framing: No.8 gauge 0.5" self-drilling wafer head (mod. Truss) Phillips drive																														
<input checked="" type="checkbox"/>	Hold downs: No.14 gauge1" self-drilling Hex washer head																														
<input type="checkbox"/>	Back-to-Back																														
<input checked="" type="checkbox"/>	Chord Studs: No.10 gauge 0.75" self-drilling Hex washer head																														
<input type="checkbox"/>	Anchor Rods: 7/8" A193 Rod																														
<input checked="" type="checkbox"/>	1" A193 Rod																														
<input checked="" type="checkbox"/>	Loading Beam: A325 3/4" bolts																														
<input checked="" type="checkbox"/>	Base: A325 3/4" bolts																														
TRACK:	<table border="1" style="width:100%; border-collapse: collapse;"> <tr><td><input checked="" type="checkbox"/></td><td>Regular</td></tr> <tr><td><input type="checkbox"/></td><td>Extended</td></tr> <tr><td><input type="checkbox"/></td><td>Reinforced</td></tr> </table>		<input checked="" type="checkbox"/>	Regular	<input type="checkbox"/>	Extended	<input type="checkbox"/>	Reinforced	<table border="1" style="width:100%; border-collapse: collapse;"> <tr><td><input checked="" type="checkbox"/></td><td>6" web</td></tr> <tr><td><input type="checkbox"/></td><td>3 5/8" web</td></tr> <tr><td><input type="checkbox"/></td><td>1-1/4" flange</td></tr> </table>	<input checked="" type="checkbox"/>	6" web	<input type="checkbox"/>	3 5/8" web	<input type="checkbox"/>	1-1/4" flange																
<input checked="" type="checkbox"/>	Regular																														
<input type="checkbox"/>	Extended																														
<input type="checkbox"/>	Reinforced																														
<input checked="" type="checkbox"/>	6" web																														
<input type="checkbox"/>	3 5/8" web																														
<input type="checkbox"/>	1-1/4" flange																														
	<table border="1" style="width:100%; border-collapse: collapse;"> <tr><td><input type="checkbox"/></td><td>0.043" (1.09mm) 33ksi (230 Mpa)</td></tr> <tr><td><input type="checkbox"/></td><td>0.054" (1.37mm) 50ksi (345 Mpa)</td></tr> <tr><td><input checked="" type="checkbox"/></td><td>0.068" (1.73mm) 50ksi (345 Mpa)</td></tr> <tr><td><input type="checkbox"/></td><td>0.097" (1.73mm) 50ksi (345 Mpa)</td></tr> </table>		<input type="checkbox"/>	0.043" (1.09mm) 33ksi (230 Mpa)	<input type="checkbox"/>	0.054" (1.37mm) 50ksi (345 Mpa)	<input checked="" type="checkbox"/>	0.068" (1.73mm) 50ksi (345 Mpa)	<input type="checkbox"/>	0.097" (1.73mm) 50ksi (345 Mpa)	<table border="1" style="width:100%; border-collapse: collapse;"> <tr><td>4 bolts</td><td><input checked="" type="checkbox"/></td><td>2 Anchor Rods</td><td><input checked="" type="checkbox"/></td></tr> <tr><td>4 bolts</td><td><input checked="" type="checkbox"/></td><td>2 Anchor Rods</td><td><input checked="" type="checkbox"/></td></tr> </table>	4 bolts	<input checked="" type="checkbox"/>	2 Anchor Rods	<input checked="" type="checkbox"/>	4 bolts	<input checked="" type="checkbox"/>	2 Anchor Rods	<input checked="" type="checkbox"/>												
<input type="checkbox"/>	0.043" (1.09mm) 33ksi (230 Mpa)																														
<input type="checkbox"/>	0.054" (1.37mm) 50ksi (345 Mpa)																														
<input checked="" type="checkbox"/>	0.068" (1.73mm) 50ksi (345 Mpa)																														
<input type="checkbox"/>	0.097" (1.73mm) 50ksi (345 Mpa)																														
4 bolts	<input checked="" type="checkbox"/>	2 Anchor Rods	<input checked="" type="checkbox"/>																												
4 bolts	<input checked="" type="checkbox"/>	2 Anchor Rods	<input checked="" type="checkbox"/>																												
HOLD DOWNS:	<table border="1" style="width:100%; border-collapse: collapse;"> <tr><td><input type="checkbox"/></td><td>S/HD10S Simpson</td></tr> <tr><td><input type="checkbox"/></td><td>Fabricated U-shape</td></tr> <tr><td><input type="checkbox"/></td><td>6" x 6" 0.054" (1.37mm) 50 ksi (340 MPa) Gusset Plate w/ S/HD15S Simpson</td></tr> <tr><td><input type="checkbox"/></td><td>7" x 9" 0.054" (1.37mm) 50 ksi (340 MPa) Gusset Plate w/ S/HD15S Simpson</td></tr> <tr><td><input checked="" type="checkbox"/></td><td>8" x 8" 0.068" (1.73mm) 50 ksi (340 MPa) Gusset Plate w/ S/HD15S Simpson</td></tr> <tr><td><input type="checkbox"/></td><td>8.5" x10" 0.068" (1.73mm) 50 ksi (340 MPa) Gusset Plate w/ S/HD15S Simpson</td></tr> <tr><td><input type="checkbox"/></td><td>10" x10" 0.054" (1.37mm) 50 ksi (340 MPa) Gusset Plate w/ S/HD15S Simpson</td></tr> </table>			<input type="checkbox"/>	S/HD10S Simpson	<input type="checkbox"/>	Fabricated U-shape	<input type="checkbox"/>	6" x 6" 0.054" (1.37mm) 50 ksi (340 MPa) Gusset Plate w/ S/HD15S Simpson	<input type="checkbox"/>	7" x 9" 0.054" (1.37mm) 50 ksi (340 MPa) Gusset Plate w/ S/HD15S Simpson	<input checked="" type="checkbox"/>	8" x 8" 0.068" (1.73mm) 50 ksi (340 MPa) Gusset Plate w/ S/HD15S Simpson	<input type="checkbox"/>	8.5" x10" 0.068" (1.73mm) 50 ksi (340 MPa) Gusset Plate w/ S/HD15S Simpson	<input type="checkbox"/>	10" x10" 0.054" (1.37mm) 50 ksi (340 MPa) Gusset Plate w/ S/HD15S Simpson														
<input type="checkbox"/>	S/HD10S Simpson																														
<input type="checkbox"/>	Fabricated U-shape																														
<input type="checkbox"/>	6" x 6" 0.054" (1.37mm) 50 ksi (340 MPa) Gusset Plate w/ S/HD15S Simpson																														
<input type="checkbox"/>	7" x 9" 0.054" (1.37mm) 50 ksi (340 MPa) Gusset Plate w/ S/HD15S Simpson																														
<input checked="" type="checkbox"/>	8" x 8" 0.068" (1.73mm) 50 ksi (340 MPa) Gusset Plate w/ S/HD15S Simpson																														
<input type="checkbox"/>	8.5" x10" 0.068" (1.73mm) 50 ksi (340 MPa) Gusset Plate w/ S/HD15S Simpson																														
<input type="checkbox"/>	10" x10" 0.054" (1.37mm) 50 ksi (340 MPa) Gusset Plate w/ S/HD15S Simpson																														
TEST PROTOCOL AND DESCRIPTION:	<table border="1" style="width:100%; border-collapse: collapse;"> <tr><td><input checked="" type="checkbox"/></td><td>Monotonic (Rate of Loading 2.5 mm/min)</td></tr> <tr><td><input type="checkbox"/></td><td>Cyclic (CUREE cyclic protocol)</td></tr> </table>			<input checked="" type="checkbox"/>	Monotonic (Rate of Loading 2.5 mm/min)	<input type="checkbox"/>	Cyclic (CUREE cyclic protocol)																								
<input checked="" type="checkbox"/>	Monotonic (Rate of Loading 2.5 mm/min)																														
<input type="checkbox"/>	Cyclic (CUREE cyclic protocol)																														
LVDT MEASUREMENTS:	<table border="1" style="width:100%; border-collapse: collapse;"> <tr><td><input checked="" type="checkbox"/></td><td>Actuator LVDT</td></tr> <tr><td><input checked="" type="checkbox"/></td><td>North Slip</td></tr> <tr><td><input checked="" type="checkbox"/></td><td>South Slip</td></tr> </table>		<input checked="" type="checkbox"/>	Actuator LVDT	<input checked="" type="checkbox"/>	North Slip	<input checked="" type="checkbox"/>	South Slip	<table border="1" style="width:100%; border-collapse: collapse;"> <tr><td><input checked="" type="checkbox"/></td><td>North Uplift</td></tr> <tr><td><input checked="" type="checkbox"/></td><td>South Uplift</td></tr> <tr><td><input checked="" type="checkbox"/></td><td>Top of Wall</td></tr> </table>	<input checked="" type="checkbox"/>	North Uplift	<input checked="" type="checkbox"/>	South Uplift	<input checked="" type="checkbox"/>	Top of Wall																
<input checked="" type="checkbox"/>	Actuator LVDT																														
<input checked="" type="checkbox"/>	North Slip																														
<input checked="" type="checkbox"/>	South Slip																														
<input checked="" type="checkbox"/>	North Uplift																														
<input checked="" type="checkbox"/>	South Uplift																														
<input checked="" type="checkbox"/>	Top of Wall																														
		TOTAL: <input type="text" value="6"/>																													
STRAP WIDTH BEFORE TEST:	<table border="1" style="width:100%; border-collapse: collapse;"> <tr><td>Front Right</td><td>Front Left, mm</td><td>Back Right, mm</td><td>Back Left, mm</td></tr> <tr><td><input type="text" value="101.06"/></td><td><input type="text" value="101.11"/></td><td><input type="text" value="102.38"/></td><td><input type="text" value="102.60"/></td></tr> <tr><td><input type="text" value="101.42"/></td><td><input type="text" value="101.38"/></td><td><input type="text" value="102.34"/></td><td><input type="text" value="102.30"/></td></tr> <tr><td><input type="text" value="102.05"/></td><td><input type="text" value="102.77"/></td><td><input type="text" value="102.54"/></td><td><input type="text" value="102.51"/></td></tr> <tr><td>AVG</td><td><input type="text" value="101.51"/> mm</td><td>AVG</td><td><input type="text" value="101.75"/> mm</td></tr> <tr><td></td><td></td><td>AVG</td><td><input type="text" value="102.42"/> mm</td></tr> <tr><td></td><td></td><td>AVG</td><td><input type="text" value="102.47"/> mm</td></tr> </table>			Front Right	Front Left, mm	Back Right, mm	Back Left, mm	<input type="text" value="101.06"/>	<input type="text" value="101.11"/>	<input type="text" value="102.38"/>	<input type="text" value="102.60"/>	<input type="text" value="101.42"/>	<input type="text" value="101.38"/>	<input type="text" value="102.34"/>	<input type="text" value="102.30"/>	<input type="text" value="102.05"/>	<input type="text" value="102.77"/>	<input type="text" value="102.54"/>	<input type="text" value="102.51"/>	AVG	<input type="text" value="101.51"/> mm	AVG	<input type="text" value="101.75"/> mm			AVG	<input type="text" value="102.42"/> mm			AVG	<input type="text" value="102.47"/> mm
Front Right	Front Left, mm	Back Right, mm	Back Left, mm																												
<input type="text" value="101.06"/>	<input type="text" value="101.11"/>	<input type="text" value="102.38"/>	<input type="text" value="102.60"/>																												
<input type="text" value="101.42"/>	<input type="text" value="101.38"/>	<input type="text" value="102.34"/>	<input type="text" value="102.30"/>																												
<input type="text" value="102.05"/>	<input type="text" value="102.77"/>	<input type="text" value="102.54"/>	<input type="text" value="102.51"/>																												
AVG	<input type="text" value="101.51"/> mm	AVG	<input type="text" value="101.75"/> mm																												
		AVG	<input type="text" value="102.42"/> mm																												
		AVG	<input type="text" value="102.47"/> mm																												
DATA ACQ. RECORD RATE:	1 scan/sec		MONITOR RATE:																												
		10 scan/sec																													
COMMENTS:	<ul style="list-style-type: none"> -Shear anchors torqued for 10 s with impact wrench -Hold down anchors 1/2 turn from finger tight (load cells used on both hold-downs) -Double chord studs used screwed back to back -Square plate washers (2.5"x2.5") used in all top track connections -Regular washers used in all bottom track connections 																														

Figure E.19: Data sheet for test 23B-M



McGill

Light Gauge Steel Frame Strap Braced, Shear Wall Testing

Test name : 23B-M
 Date tested : July 16/2007
 Wall Size : 4'x 8'
 Strap Size : ~~1/2"~~ 1"
 Extended Track : yes no
 Holddown : Inside Outside
 Test mode : Cyclic Monotonic

Run First
 Front side notes: 23B-M
 b = 195mm chord stud
 failure, loss of track
 Test stopped @ A = 155mm
 stud failed
 here
 screwheads
 broke off here

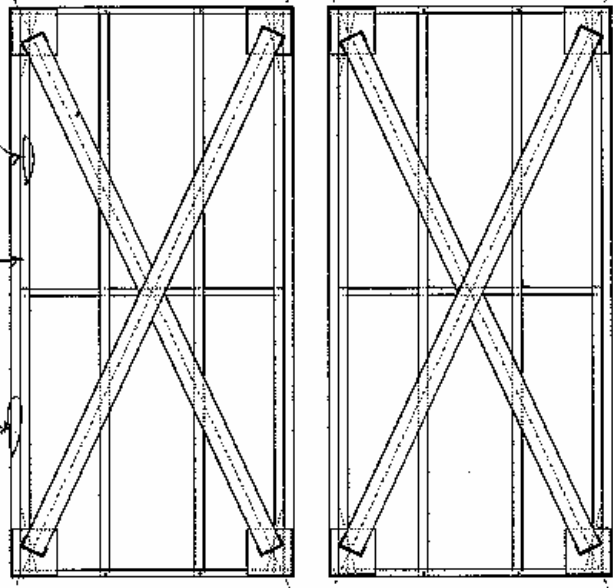

Back-side notes: 23B-M2
 • Screws through strap @ interior studs.
 • Straps initially loose.
 Test stopped when losing track due to failure of compression chord stud

(N) Front (S) (S) Back (N)

Figure E.20: Observations for test 23B-M

Cold Formed Steel Strap Braced Walls																																						
McGill University, Montreal																																						
TEST: 23C-M																																						
RESEARCHER: Gilles Comeau		ASSISTANTS: Kostadin Velchev, Nisreen Bah																																				
DATE: 17-Jul-07		TIME: 11:30AM																																				
DIMENSIONS OF WALL: 2 FT X 8 FT X 6 IN.		INITIAL STRAP SURVEY: Front Right Tight, Back Left Tight, Loose, Loose																																				
STRAP FASTENER CONFIGURATION: MFR: McGill																																						
																																						
STRAP SIZE:	<table border="1" style="width: 100%; border-collapse: collapse;"> <tr><td><input type="checkbox"/></td><td>2.5" 0.043" (1.09mm) 33 ksi (230 MPa)</td></tr> <tr><td><input type="checkbox"/></td><td>2.75" 0.054" (1.37mm) 50 ksi (340 MPa)</td></tr> <tr><td><input checked="" type="checkbox"/></td><td>4" 0.068" (1.73mm) 50 ksi (340 MPa)</td></tr> <tr><td><input type="checkbox"/></td><td>5" 0.043" (1.09) 33 ksi (230 MPa)</td></tr> <tr><td><input type="checkbox"/></td><td>Reduced section strap -- fuse = 2.5" wide x 30" long -- ends = 3.75" wide 0.043" (1.09mm) 33 ksi (230 MPa)</td></tr> <tr><td><input type="checkbox"/></td><td>Reduced section strap -- fuse = 2.75" wide x 30" long -- ends = 4.25" wide 0.054" (1.37mm) 50 ksi (340 MPa)</td></tr> <tr><td><input type="checkbox"/></td><td>Reduced section strap -- fuse = 4" wide x 30" long -- ends = 6" wide 0.068" (1.73mm) 50 ksi (340 MPa)</td></tr> <tr><td><input type="checkbox"/></td><td>Reduced section strap -- fuse = 2.5" wide x 60" long -- ends = 3.75" wide 0.043" (1.09mm) 33 ksi (230 MPa)</td></tr> <tr><td><input type="checkbox"/></td><td>Reduced section strap -- fuse = 4" wide x 60" long -- ends = 6" wide 0.068" (1.73mm) 50 ksi (340 MPa)</td></tr> </table>			<input type="checkbox"/>	2.5" 0.043" (1.09mm) 33 ksi (230 MPa)	<input type="checkbox"/>	2.75" 0.054" (1.37mm) 50 ksi (340 MPa)	<input checked="" type="checkbox"/>	4" 0.068" (1.73mm) 50 ksi (340 MPa)	<input type="checkbox"/>	5" 0.043" (1.09) 33 ksi (230 MPa)	<input type="checkbox"/>	Reduced section strap -- fuse = 2.5" wide x 30" long -- ends = 3.75" wide 0.043" (1.09mm) 33 ksi (230 MPa)	<input type="checkbox"/>	Reduced section strap -- fuse = 2.75" wide x 30" long -- ends = 4.25" wide 0.054" (1.37mm) 50 ksi (340 MPa)	<input type="checkbox"/>	Reduced section strap -- fuse = 4" wide x 30" long -- ends = 6" wide 0.068" (1.73mm) 50 ksi (340 MPa)	<input type="checkbox"/>	Reduced section strap -- fuse = 2.5" wide x 60" long -- ends = 3.75" wide 0.043" (1.09mm) 33 ksi (230 MPa)	<input type="checkbox"/>	Reduced section strap -- fuse = 4" wide x 60" long -- ends = 6" wide 0.068" (1.73mm) 50 ksi (340 MPa)																	
<input type="checkbox"/>	2.5" 0.043" (1.09mm) 33 ksi (230 MPa)																																					
<input type="checkbox"/>	2.75" 0.054" (1.37mm) 50 ksi (340 MPa)																																					
<input checked="" type="checkbox"/>	4" 0.068" (1.73mm) 50 ksi (340 MPa)																																					
<input type="checkbox"/>	5" 0.043" (1.09) 33 ksi (230 MPa)																																					
<input type="checkbox"/>	Reduced section strap -- fuse = 2.5" wide x 30" long -- ends = 3.75" wide 0.043" (1.09mm) 33 ksi (230 MPa)																																					
<input type="checkbox"/>	Reduced section strap -- fuse = 2.75" wide x 30" long -- ends = 4.25" wide 0.054" (1.37mm) 50 ksi (340 MPa)																																					
<input type="checkbox"/>	Reduced section strap -- fuse = 4" wide x 30" long -- ends = 6" wide 0.068" (1.73mm) 50 ksi (340 MPa)																																					
<input type="checkbox"/>	Reduced section strap -- fuse = 2.5" wide x 60" long -- ends = 3.75" wide 0.043" (1.09mm) 33 ksi (230 MPa)																																					
<input type="checkbox"/>	Reduced section strap -- fuse = 4" wide x 60" long -- ends = 6" wide 0.068" (1.73mm) 50 ksi (340 MPa)																																					
INTERIOR STUDS:	<table border="1" style="width: 100%; border-collapse: collapse;"> <tr><td><input type="checkbox"/></td><td>3-5/8"Wx1-5/8"Fx1/2"Lip 0.043" (1.09mm) 33ksi (230 Mpa)</td></tr> <tr><td><input checked="" type="checkbox"/></td><td>6"Wx1-5/8"Fx1/2"Lip 0.043" (1.09mm) 33ksi (230 Mpa)</td></tr> </table>		<input type="checkbox"/>	3-5/8"Wx1-5/8"Fx1/2"Lip 0.043" (1.09mm) 33ksi (230 Mpa)	<input checked="" type="checkbox"/>	6"Wx1-5/8"Fx1/2"Lip 0.043" (1.09mm) 33ksi (230 Mpa)	STUD SPACING: <input checked="" type="checkbox"/> 16" O.C. Other: _____																															
<input type="checkbox"/>	3-5/8"Wx1-5/8"Fx1/2"Lip 0.043" (1.09mm) 33ksi (230 Mpa)																																					
<input checked="" type="checkbox"/>	6"Wx1-5/8"Fx1/2"Lip 0.043" (1.09mm) 33ksi (230 Mpa)																																					
BACK-TO-BACK CHORD STUDS:	<table border="1" style="width: 100%; border-collapse: collapse;"> <tr><td><input type="checkbox"/></td><td>3-5/8"Wx1-5/8"Fx1/2"Lip 0.043" (1.09mm) 33ksi (230 Mpa)</td></tr> <tr><td><input type="checkbox"/></td><td>6"Wx1-5/8"Fx1/2"Lip 0.054" (1.37mm) 50ksi (345 Mpa)</td></tr> <tr><td><input checked="" type="checkbox"/></td><td>6"Wx1-5/8"Fx1/2"Lip 0.068" (1.73mm) 50ksi (345 Mpa)</td></tr> </table>			<input type="checkbox"/>	3-5/8"Wx1-5/8"Fx1/2"Lip 0.043" (1.09mm) 33ksi (230 Mpa)	<input type="checkbox"/>	6"Wx1-5/8"Fx1/2"Lip 0.054" (1.37mm) 50ksi (345 Mpa)	<input checked="" type="checkbox"/>	6"Wx1-5/8"Fx1/2"Lip 0.068" (1.73mm) 50ksi (345 Mpa)																													
<input type="checkbox"/>	3-5/8"Wx1-5/8"Fx1/2"Lip 0.043" (1.09mm) 33ksi (230 Mpa)																																					
<input type="checkbox"/>	6"Wx1-5/8"Fx1/2"Lip 0.054" (1.37mm) 50ksi (345 Mpa)																																					
<input checked="" type="checkbox"/>	6"Wx1-5/8"Fx1/2"Lip 0.068" (1.73mm) 50ksi (345 Mpa)																																					
CONNECTIONS:	<table border="1" style="width: 100%; border-collapse: collapse;"> <tr><td><input checked="" type="checkbox"/></td><td>No.10 gauge 0.75" self-drilling wafer head (mod. Truss) Phillips drive</td></tr> <tr><td><input checked="" type="checkbox"/></td><td>Framing: No.8 gauge 0.5" self-drilling wafer head (mod. Truss) Phillips drive</td></tr> <tr><td><input checked="" type="checkbox"/></td><td>Hold downs: No.14 gauge 1" self-drilling Hex washer head</td></tr> <tr><td><input type="checkbox"/></td><td>Back-to-Back Chord Studs: No.10 gauge 0.75" self-drilling Hex washer head</td></tr> <tr><td><input type="checkbox"/></td><td>Anchor Rods: 7/8" A193 Rod</td></tr> <tr><td><input type="checkbox"/></td><td><input type="checkbox"/></td><td>1" A193 Rod</td></tr> <tr><td><input checked="" type="checkbox"/></td><td>Loading Beam: A325 3/4" bolts</td></tr> <tr><td><input checked="" type="checkbox"/></td><td>Base: A325 3/4" bolts</td></tr> </table>			<input checked="" type="checkbox"/>	No.10 gauge 0.75" self-drilling wafer head (mod. Truss) Phillips drive	<input checked="" type="checkbox"/>	Framing: No.8 gauge 0.5" self-drilling wafer head (mod. Truss) Phillips drive	<input checked="" type="checkbox"/>	Hold downs: No.14 gauge 1" self-drilling Hex washer head	<input type="checkbox"/>	Back-to-Back Chord Studs: No.10 gauge 0.75" self-drilling Hex washer head	<input type="checkbox"/>	Anchor Rods: 7/8" A193 Rod	<input type="checkbox"/>	<input type="checkbox"/>	1" A193 Rod	<input checked="" type="checkbox"/>	Loading Beam: A325 3/4" bolts	<input checked="" type="checkbox"/>	Base: A325 3/4" bolts																		
<input checked="" type="checkbox"/>	No.10 gauge 0.75" self-drilling wafer head (mod. Truss) Phillips drive																																					
<input checked="" type="checkbox"/>	Framing: No.8 gauge 0.5" self-drilling wafer head (mod. Truss) Phillips drive																																					
<input checked="" type="checkbox"/>	Hold downs: No.14 gauge 1" self-drilling Hex washer head																																					
<input type="checkbox"/>	Back-to-Back Chord Studs: No.10 gauge 0.75" self-drilling Hex washer head																																					
<input type="checkbox"/>	Anchor Rods: 7/8" A193 Rod																																					
<input type="checkbox"/>	<input type="checkbox"/>	1" A193 Rod																																				
<input checked="" type="checkbox"/>	Loading Beam: A325 3/4" bolts																																					
<input checked="" type="checkbox"/>	Base: A325 3/4" bolts																																					
TRACK:	<table border="1" style="width: 100%; border-collapse: collapse;"> <tr><td><input checked="" type="checkbox"/></td><td>Regular</td><td><input checked="" type="checkbox"/></td><td>6" web</td><td><input type="checkbox"/></td><td>0.043" (1.09mm) 33ksi (230 Mpa)</td></tr> <tr><td><input type="checkbox"/></td><td>Extended</td><td><input type="checkbox"/></td><td>3 5/8" web</td><td><input type="checkbox"/></td><td>0.054" (1.37mm) 50ksi (345 Mpa)</td></tr> <tr><td><input type="checkbox"/></td><td>Reinforced</td><td><input type="checkbox"/></td><td>1-1/4" flange</td><td><input checked="" type="checkbox"/></td><td>0.068" (1.73mm) 50ksi (345 Mpa)</td></tr> <tr><td><input type="checkbox"/></td><td></td><td><input type="checkbox"/></td><td></td><td><input type="checkbox"/></td><td>0.097" (1.73mm) 50ksi (345 Mpa)</td></tr> </table>			<input checked="" type="checkbox"/>	Regular	<input checked="" type="checkbox"/>	6" web	<input type="checkbox"/>	0.043" (1.09mm) 33ksi (230 Mpa)	<input type="checkbox"/>	Extended	<input type="checkbox"/>	3 5/8" web	<input type="checkbox"/>	0.054" (1.37mm) 50ksi (345 Mpa)	<input type="checkbox"/>	Reinforced	<input type="checkbox"/>	1-1/4" flange	<input checked="" type="checkbox"/>	0.068" (1.73mm) 50ksi (345 Mpa)	<input type="checkbox"/>		<input type="checkbox"/>		<input type="checkbox"/>	0.097" (1.73mm) 50ksi (345 Mpa)											
<input checked="" type="checkbox"/>	Regular	<input checked="" type="checkbox"/>	6" web	<input type="checkbox"/>	0.043" (1.09mm) 33ksi (230 Mpa)																																	
<input type="checkbox"/>	Extended	<input type="checkbox"/>	3 5/8" web	<input type="checkbox"/>	0.054" (1.37mm) 50ksi (345 Mpa)																																	
<input type="checkbox"/>	Reinforced	<input type="checkbox"/>	1-1/4" flange	<input checked="" type="checkbox"/>	0.068" (1.73mm) 50ksi (345 Mpa)																																	
<input type="checkbox"/>		<input type="checkbox"/>		<input type="checkbox"/>	0.097" (1.73mm) 50ksi (345 Mpa)																																	
HOLD DOWNS:	<table border="1" style="width: 100%; border-collapse: collapse;"> <tr><td><input type="checkbox"/></td><td>S/HD10S Simpson</td><td>inside</td><td>outside</td><td>raised</td></tr> <tr><td><input type="checkbox"/></td><td>Fabricated U-shape</td><td></td><td></td><td></td></tr> <tr><td><input type="checkbox"/></td><td>6" x 6" 0.054" (1.37mm) 50 ksi (340 MPa) Gusset Plate w/ S/HD15S Simpson</td><td></td><td></td><td></td></tr> <tr><td><input type="checkbox"/></td><td>7" x 9" 0.054" (1.37mm) 50 ksi (340 MPa) Gusset Plate w/ S/HD15S Simpson</td><td></td><td></td><td></td></tr> <tr><td><input checked="" type="checkbox"/></td><td>8" x 8" 0.068" (1.73mm) 50 ksi (340 MPa) Gusset Plate w/ S/HD15S Simpson</td><td><input checked="" type="checkbox"/></td><td></td><td></td></tr> <tr><td><input type="checkbox"/></td><td>8.5" x10" 0.068" (1.73mm) 50 ksi (340 MPa) Gusset Plate w/ S/HD15S Simpson</td><td></td><td></td><td></td></tr> <tr><td><input type="checkbox"/></td><td>10" x10" 0.054" (1.37mm) 50 ksi (340 MPa) Gusset Plate w/ S/HD15S Simpson</td><td></td><td></td><td></td></tr> </table>			<input type="checkbox"/>	S/HD10S Simpson	inside	outside	raised	<input type="checkbox"/>	Fabricated U-shape				<input type="checkbox"/>	6" x 6" 0.054" (1.37mm) 50 ksi (340 MPa) Gusset Plate w/ S/HD15S Simpson				<input type="checkbox"/>	7" x 9" 0.054" (1.37mm) 50 ksi (340 MPa) Gusset Plate w/ S/HD15S Simpson				<input checked="" type="checkbox"/>	8" x 8" 0.068" (1.73mm) 50 ksi (340 MPa) Gusset Plate w/ S/HD15S Simpson	<input checked="" type="checkbox"/>			<input type="checkbox"/>	8.5" x10" 0.068" (1.73mm) 50 ksi (340 MPa) Gusset Plate w/ S/HD15S Simpson				<input type="checkbox"/>	10" x10" 0.054" (1.37mm) 50 ksi (340 MPa) Gusset Plate w/ S/HD15S Simpson			
<input type="checkbox"/>	S/HD10S Simpson	inside	outside	raised																																		
<input type="checkbox"/>	Fabricated U-shape																																					
<input type="checkbox"/>	6" x 6" 0.054" (1.37mm) 50 ksi (340 MPa) Gusset Plate w/ S/HD15S Simpson																																					
<input type="checkbox"/>	7" x 9" 0.054" (1.37mm) 50 ksi (340 MPa) Gusset Plate w/ S/HD15S Simpson																																					
<input checked="" type="checkbox"/>	8" x 8" 0.068" (1.73mm) 50 ksi (340 MPa) Gusset Plate w/ S/HD15S Simpson	<input checked="" type="checkbox"/>																																				
<input type="checkbox"/>	8.5" x10" 0.068" (1.73mm) 50 ksi (340 MPa) Gusset Plate w/ S/HD15S Simpson																																					
<input type="checkbox"/>	10" x10" 0.054" (1.37mm) 50 ksi (340 MPa) Gusset Plate w/ S/HD15S Simpson																																					
TEST PROTOCOL AND DESCRIPTION:	<table border="1" style="width: 100%; border-collapse: collapse;"> <tr><td><input checked="" type="checkbox"/></td><td>Monotonic (Rate of Loading 2.5 mm/min)</td></tr> <tr><td><input type="checkbox"/></td><td>Cyclic (CUREE cyclic protocol)</td></tr> </table>			<input checked="" type="checkbox"/>	Monotonic (Rate of Loading 2.5 mm/min)	<input type="checkbox"/>	Cyclic (CUREE cyclic protocol)																															
<input checked="" type="checkbox"/>	Monotonic (Rate of Loading 2.5 mm/min)																																					
<input type="checkbox"/>	Cyclic (CUREE cyclic protocol)																																					
LVDT MEASUREMENTS:	<table border="1" style="width: 100%; border-collapse: collapse;"> <tr><td><input checked="" type="checkbox"/></td><td>Actuator LVDT</td><td><input checked="" type="checkbox"/></td><td>North Uplift</td></tr> <tr><td><input checked="" type="checkbox"/></td><td>North Slip</td><td><input checked="" type="checkbox"/></td><td>South Uplift</td></tr> <tr><td><input checked="" type="checkbox"/></td><td>South Slip</td><td><input checked="" type="checkbox"/></td><td>Top of Wall</td></tr> </table>			<input checked="" type="checkbox"/>	Actuator LVDT	<input checked="" type="checkbox"/>	North Uplift	<input checked="" type="checkbox"/>	North Slip	<input checked="" type="checkbox"/>	South Uplift	<input checked="" type="checkbox"/>	South Slip	<input checked="" type="checkbox"/>	Top of Wall																							
<input checked="" type="checkbox"/>	Actuator LVDT	<input checked="" type="checkbox"/>	North Uplift																																			
<input checked="" type="checkbox"/>	North Slip	<input checked="" type="checkbox"/>	South Uplift																																			
<input checked="" type="checkbox"/>	South Slip	<input checked="" type="checkbox"/>	Top of Wall																																			
			TOTAL: <input type="text" value="6"/>																																			
STRAP WIDTH BEFORE TEST:	<table border="1" style="width: 100%; border-collapse: collapse;"> <tr><td>Front Right</td><td>Front Left, mm</td><td>Back Right, mm</td><td>Back Left, mm</td></tr> <tr><td>100.92</td><td>102.44</td><td>102.32</td><td>102.28</td></tr> <tr><td>101.74</td><td>102.44</td><td>102.24</td><td>102.17</td></tr> <tr><td>101.97</td><td>102.49</td><td>102.37</td><td>102.52</td></tr> <tr><td>AVG</td><td>101.54 mm</td><td>AVG</td><td>102.31 mm</td></tr> <tr><td></td><td></td><td>AVG</td><td>102.32 mm</td></tr> </table>			Front Right	Front Left, mm	Back Right, mm	Back Left, mm	100.92	102.44	102.32	102.28	101.74	102.44	102.24	102.17	101.97	102.49	102.37	102.52	AVG	101.54 mm	AVG	102.31 mm			AVG	102.32 mm											
Front Right	Front Left, mm	Back Right, mm	Back Left, mm																																			
100.92	102.44	102.32	102.28																																			
101.74	102.44	102.24	102.17																																			
101.97	102.49	102.37	102.52																																			
AVG	101.54 mm	AVG	102.31 mm																																			
		AVG	102.32 mm																																			
DATA ACQ. RECORD RATE: 1 scan/sec	MONITOR RATE: 10 scan/sec																																					
COMMENTS:																																						
-Shear anchors torqued for 10 s with impact wrench																																						
-Hold down anchors 1/2 turn from finger tight (load cells used on both hold-downs)																																						
-Double chord studs used screwed back to back																																						
-Square plate washers (2.5"x2.5") used in all top track connections																																						
-Regular washers used in all bottom track connections																																						

Figure E.21: Data sheet for test 23C-M



McGill

Light Gauge Steel Frame Stop Braced Shear Wall Testing

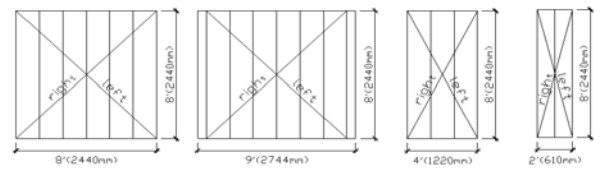
23C-M2 (Run First)
Front-side notes:
Some yielding of braces
followed by crushing
of chord ends. Looks
to be a flexural type
failure.

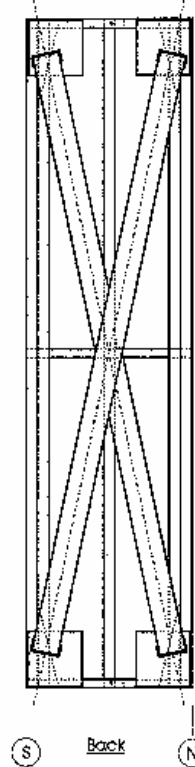
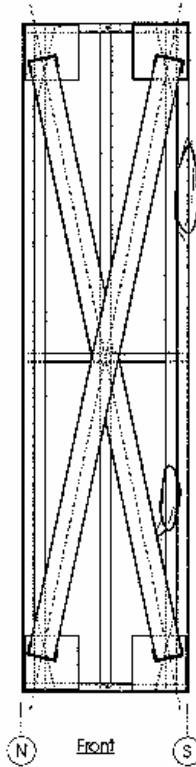

Test name : 23C-M
Date tested :
Wall Size : 2x8'
Strap Size : 4"
Extended Track : yes no
Holddown : Inside Outside
Test mode : Cyclic Monotonic

Backside notes: 23C-M

- same behavior as
23C-M2

Figure E.22: Observations for test 23C-M

Cold Formed Steel Strap Braced Walls McGill University, Montreal																																						
TEST:		14A-C																																				
RESEARCHER:	Gilles Comeau		ASSISTANTS:																																			
		Kostadin Velchev, Nisreen Balh																																				
DATE:	25-Jul-07		TIME:																																			
		2:00PM																																				
DIMENSIONS OF WALL:	8 FT X	8 FT X	3 5/8 IN.																																			
INITIAL STRAP SURVEY:	Front	Right	Left																																			
	Back	Tight	Tight																																			
		Tight	Tight																																			
STRAP FASTENER CONFIGURATION: MFR: McGill																																						
STRAP SIZE:	<table border="1" style="width: 100%; border-collapse: collapse;"> <tr><td><input checked="" type="checkbox"/></td><td>2.5" 0.043" (1.09mm) 33 ksi (230 MPa)</td></tr> <tr><td><input type="checkbox"/></td><td>2.75" 0.054" (1.37mm) 50 ksi (340 MPa)</td></tr> <tr><td><input type="checkbox"/></td><td>4" 0.068" (1.73mm) 50 ksi (340 MPa)</td></tr> <tr><td><input type="checkbox"/></td><td>5" 0.043" (1.09) 33 ksi (230 MPa)</td></tr> <tr><td><input type="checkbox"/></td><td>Reduced section strap -- fuse = 2.5" wide x 30" long -- ends = 3.75" wide 0.043" (1.09mm) 33 ksi (230 MPa)</td></tr> <tr><td><input type="checkbox"/></td><td>Reduced section strap -- fuse = 2.75" wide x 30" long -- ends = 4.25" wide 0.054" (1.37mm) 50 ksi (340 MPa)</td></tr> <tr><td><input type="checkbox"/></td><td>Reduced section strap -- fuse = 4" wide x 30" long -- ends = 6" wide 0.068" (1.73mm) 50 ksi (340 MPa)</td></tr> <tr><td><input type="checkbox"/></td><td>Reduced section strap -- fuse = 2.5" wide x 60" long -- ends = 3.75" wide 0.043" (1.09mm) 33 ksi (230 MPa)</td></tr> <tr><td><input type="checkbox"/></td><td>Reduced section strap -- fuse = 4" wide x 60" long -- ends = 6" wide 0.068" (1.73mm) 50 ksi (340 MPa)</td></tr> </table>			<input checked="" type="checkbox"/>	2.5" 0.043" (1.09mm) 33 ksi (230 MPa)	<input type="checkbox"/>	2.75" 0.054" (1.37mm) 50 ksi (340 MPa)	<input type="checkbox"/>	4" 0.068" (1.73mm) 50 ksi (340 MPa)	<input type="checkbox"/>	5" 0.043" (1.09) 33 ksi (230 MPa)	<input type="checkbox"/>	Reduced section strap -- fuse = 2.5" wide x 30" long -- ends = 3.75" wide 0.043" (1.09mm) 33 ksi (230 MPa)	<input type="checkbox"/>	Reduced section strap -- fuse = 2.75" wide x 30" long -- ends = 4.25" wide 0.054" (1.37mm) 50 ksi (340 MPa)	<input type="checkbox"/>	Reduced section strap -- fuse = 4" wide x 30" long -- ends = 6" wide 0.068" (1.73mm) 50 ksi (340 MPa)	<input type="checkbox"/>	Reduced section strap -- fuse = 2.5" wide x 60" long -- ends = 3.75" wide 0.043" (1.09mm) 33 ksi (230 MPa)	<input type="checkbox"/>	Reduced section strap -- fuse = 4" wide x 60" long -- ends = 6" wide 0.068" (1.73mm) 50 ksi (340 MPa)																	
<input checked="" type="checkbox"/>	2.5" 0.043" (1.09mm) 33 ksi (230 MPa)																																					
<input type="checkbox"/>	2.75" 0.054" (1.37mm) 50 ksi (340 MPa)																																					
<input type="checkbox"/>	4" 0.068" (1.73mm) 50 ksi (340 MPa)																																					
<input type="checkbox"/>	5" 0.043" (1.09) 33 ksi (230 MPa)																																					
<input type="checkbox"/>	Reduced section strap -- fuse = 2.5" wide x 30" long -- ends = 3.75" wide 0.043" (1.09mm) 33 ksi (230 MPa)																																					
<input type="checkbox"/>	Reduced section strap -- fuse = 2.75" wide x 30" long -- ends = 4.25" wide 0.054" (1.37mm) 50 ksi (340 MPa)																																					
<input type="checkbox"/>	Reduced section strap -- fuse = 4" wide x 30" long -- ends = 6" wide 0.068" (1.73mm) 50 ksi (340 MPa)																																					
<input type="checkbox"/>	Reduced section strap -- fuse = 2.5" wide x 60" long -- ends = 3.75" wide 0.043" (1.09mm) 33 ksi (230 MPa)																																					
<input type="checkbox"/>	Reduced section strap -- fuse = 4" wide x 60" long -- ends = 6" wide 0.068" (1.73mm) 50 ksi (340 MPa)																																					
INTERIOR STUDS:	<table border="1" style="width: 100%; border-collapse: collapse;"> <tr><td><input checked="" type="checkbox"/></td><td>3-5/8"Wx1-5/8"Fx1/2"Lip 0.043" (1.09mm) 33ksi (230 Mpa)</td></tr> <tr><td><input type="checkbox"/></td><td>6"Wx1-5/8"Fx1/2"Lip 0.043" (1.09mm) 33ksi (230 Mpa)</td></tr> </table>		<input checked="" type="checkbox"/>	3-5/8"Wx1-5/8"Fx1/2"Lip 0.043" (1.09mm) 33ksi (230 Mpa)	<input type="checkbox"/>	6"Wx1-5/8"Fx1/2"Lip 0.043" (1.09mm) 33ksi (230 Mpa)	STUD SPACING:																															
<input checked="" type="checkbox"/>	3-5/8"Wx1-5/8"Fx1/2"Lip 0.043" (1.09mm) 33ksi (230 Mpa)																																					
<input type="checkbox"/>	6"Wx1-5/8"Fx1/2"Lip 0.043" (1.09mm) 33ksi (230 Mpa)																																					
		<input checked="" type="checkbox"/>	16" O.C.																																			
		<input type="checkbox"/>	Other :																																			
BACK-TO-BACK CHORD STUDS:	<table border="1" style="width: 100%; border-collapse: collapse;"> <tr><td><input checked="" type="checkbox"/></td><td>3-5/8"Wx1-5/8"Fx1/2"Lip 0.043" (1.09mm) 33ksi (230 Mpa)</td></tr> <tr><td><input type="checkbox"/></td><td>6"Wx1-5/8"Fx1/2"Lip 0.054" (1.37mm) 50ksi (345 Mpa)</td></tr> <tr><td><input type="checkbox"/></td><td>6"Wx1-5/8"Fx1/2"Lip 0.068" (1.73mm) 50ksi (345 Mpa)</td></tr> </table>			<input checked="" type="checkbox"/>	3-5/8"Wx1-5/8"Fx1/2"Lip 0.043" (1.09mm) 33ksi (230 Mpa)	<input type="checkbox"/>	6"Wx1-5/8"Fx1/2"Lip 0.054" (1.37mm) 50ksi (345 Mpa)	<input type="checkbox"/>	6"Wx1-5/8"Fx1/2"Lip 0.068" (1.73mm) 50ksi (345 Mpa)																													
<input checked="" type="checkbox"/>	3-5/8"Wx1-5/8"Fx1/2"Lip 0.043" (1.09mm) 33ksi (230 Mpa)																																					
<input type="checkbox"/>	6"Wx1-5/8"Fx1/2"Lip 0.054" (1.37mm) 50ksi (345 Mpa)																																					
<input type="checkbox"/>	6"Wx1-5/8"Fx1/2"Lip 0.068" (1.73mm) 50ksi (345 Mpa)																																					
CONNECTIONS:	<table border="1" style="width: 100%; border-collapse: collapse;"> <tr><td><input checked="" type="checkbox"/></td><td>No.10 gauge 0.75" self-drilling wafer head (mod. Truss) Phillips drive</td></tr> <tr><td><input checked="" type="checkbox"/></td><td>No.8 gauge 0.5" self-drilling wafer head (mod. Truss) Phillips drive</td></tr> <tr><td><input checked="" type="checkbox"/></td><td>No.14 gauge 0.1" self-drilling Hex washer head</td></tr> <tr><td><input type="checkbox"/></td><td>Back-to-Back</td></tr> <tr><td><input checked="" type="checkbox"/></td><td>Chord Studs: No.10 gauge 0.75" self-drilling Hex washer head</td></tr> <tr><td><input type="checkbox"/></td><td>Anchor Rods: 7/8" A193 Rod</td></tr> <tr><td><input type="checkbox"/></td><td>1" A193 Rod</td></tr> <tr><td><input checked="" type="checkbox"/></td><td>Loading Beam: A325 3/4" bolts</td></tr> <tr><td><input checked="" type="checkbox"/></td><td>Base: A325 3/4" bolts</td></tr> </table>			<input checked="" type="checkbox"/>	No.10 gauge 0.75" self-drilling wafer head (mod. Truss) Phillips drive	<input checked="" type="checkbox"/>	No.8 gauge 0.5" self-drilling wafer head (mod. Truss) Phillips drive	<input checked="" type="checkbox"/>	No.14 gauge 0.1" self-drilling Hex washer head	<input type="checkbox"/>	Back-to-Back	<input checked="" type="checkbox"/>	Chord Studs: No.10 gauge 0.75" self-drilling Hex washer head	<input type="checkbox"/>	Anchor Rods: 7/8" A193 Rod	<input type="checkbox"/>	1" A193 Rod	<input checked="" type="checkbox"/>	Loading Beam: A325 3/4" bolts	<input checked="" type="checkbox"/>	Base: A325 3/4" bolts																	
<input checked="" type="checkbox"/>	No.10 gauge 0.75" self-drilling wafer head (mod. Truss) Phillips drive																																					
<input checked="" type="checkbox"/>	No.8 gauge 0.5" self-drilling wafer head (mod. Truss) Phillips drive																																					
<input checked="" type="checkbox"/>	No.14 gauge 0.1" self-drilling Hex washer head																																					
<input type="checkbox"/>	Back-to-Back																																					
<input checked="" type="checkbox"/>	Chord Studs: No.10 gauge 0.75" self-drilling Hex washer head																																					
<input type="checkbox"/>	Anchor Rods: 7/8" A193 Rod																																					
<input type="checkbox"/>	1" A193 Rod																																					
<input checked="" type="checkbox"/>	Loading Beam: A325 3/4" bolts																																					
<input checked="" type="checkbox"/>	Base: A325 3/4" bolts																																					
	10 bolts	<input checked="" type="checkbox"/>	2 Anchor Rods																																			
	6 bolts	<input checked="" type="checkbox"/>	2 Anchor Rods																																			
TRACK:	<table border="1" style="width: 100%; border-collapse: collapse;"> <tr><td><input type="checkbox"/></td><td>Regular</td><td><input type="checkbox"/></td><td>6" web</td><td><input checked="" type="checkbox"/></td><td>0.043" (1.09mm) 33ksi (230 Mpa)</td></tr> <tr><td><input checked="" type="checkbox"/></td><td>Extended</td><td><input checked="" type="checkbox"/></td><td>3 5/8" web</td><td><input type="checkbox"/></td><td>0.054" (1.37mm) 50ksi (345 Mpa)</td></tr> <tr><td><input type="checkbox"/></td><td>Reinforced</td><td><input type="checkbox"/></td><td>1-1/4" flange</td><td><input type="checkbox"/></td><td>0.068" (1.73mm) 50ksi (345 Mpa)</td></tr> </table>			<input type="checkbox"/>	Regular	<input type="checkbox"/>	6" web	<input checked="" type="checkbox"/>	0.043" (1.09mm) 33ksi (230 Mpa)	<input checked="" type="checkbox"/>	Extended	<input checked="" type="checkbox"/>	3 5/8" web	<input type="checkbox"/>	0.054" (1.37mm) 50ksi (345 Mpa)	<input type="checkbox"/>	Reinforced	<input type="checkbox"/>	1-1/4" flange	<input type="checkbox"/>	0.068" (1.73mm) 50ksi (345 Mpa)																	
<input type="checkbox"/>	Regular	<input type="checkbox"/>	6" web	<input checked="" type="checkbox"/>	0.043" (1.09mm) 33ksi (230 Mpa)																																	
<input checked="" type="checkbox"/>	Extended	<input checked="" type="checkbox"/>	3 5/8" web	<input type="checkbox"/>	0.054" (1.37mm) 50ksi (345 Mpa)																																	
<input type="checkbox"/>	Reinforced	<input type="checkbox"/>	1-1/4" flange	<input type="checkbox"/>	0.068" (1.73mm) 50ksi (345 Mpa)																																	
HOLD DOWNS:	<table border="1" style="width: 100%; border-collapse: collapse;"> <tr><td><input checked="" type="checkbox"/></td><td>S/HD10S Simpson</td><td>inside</td><td>outside</td><td>raised</td></tr> <tr><td><input type="checkbox"/></td><td>Fabricated U-shape</td><td><input type="checkbox"/></td><td><input type="checkbox"/></td><td><input type="checkbox"/></td></tr> <tr><td><input type="checkbox"/></td><td>6" x 6" 0.054" (1.37mm) 50 ksi (340 MPa) Gusset Plate w/ S/HD15SS Simpson</td><td><input type="checkbox"/></td><td><input type="checkbox"/></td><td><input type="checkbox"/></td></tr> <tr><td><input type="checkbox"/></td><td>7" x 9" 0.054" (1.37mm) 50 ksi (340 MPa) Gusset Plate w/ S/HD15SS Simpson</td><td><input type="checkbox"/></td><td><input type="checkbox"/></td><td><input type="checkbox"/></td></tr> <tr><td><input type="checkbox"/></td><td>8" x 8" 0.068" (1.73mm) 50 ksi (340 MPa) Gusset Plate w/ S/HD15SS Simpson</td><td><input type="checkbox"/></td><td><input type="checkbox"/></td><td><input type="checkbox"/></td></tr> <tr><td><input type="checkbox"/></td><td>8.5" x 10" 0.068" (1.73mm) 50 ksi (340 MPa) Gusset Plate w/ S/HD15SS Simpson</td><td><input type="checkbox"/></td><td><input type="checkbox"/></td><td><input type="checkbox"/></td></tr> <tr><td><input type="checkbox"/></td><td>10" x 10" 0.054" (1.37mm) 50 ksi (340 MPa) Gusset Plate w/ S/HD15SS Simpson</td><td><input type="checkbox"/></td><td><input type="checkbox"/></td><td><input type="checkbox"/></td></tr> </table>			<input checked="" type="checkbox"/>	S/HD10S Simpson	inside	outside	raised	<input type="checkbox"/>	Fabricated U-shape	<input type="checkbox"/>	<input type="checkbox"/>	<input type="checkbox"/>	<input type="checkbox"/>	6" x 6" 0.054" (1.37mm) 50 ksi (340 MPa) Gusset Plate w/ S/HD15SS Simpson	<input type="checkbox"/>	<input type="checkbox"/>	<input type="checkbox"/>	<input type="checkbox"/>	7" x 9" 0.054" (1.37mm) 50 ksi (340 MPa) Gusset Plate w/ S/HD15SS Simpson	<input type="checkbox"/>	<input type="checkbox"/>	<input type="checkbox"/>	<input type="checkbox"/>	8" x 8" 0.068" (1.73mm) 50 ksi (340 MPa) Gusset Plate w/ S/HD15SS Simpson	<input type="checkbox"/>	<input type="checkbox"/>	<input type="checkbox"/>	<input type="checkbox"/>	8.5" x 10" 0.068" (1.73mm) 50 ksi (340 MPa) Gusset Plate w/ S/HD15SS Simpson	<input type="checkbox"/>	<input type="checkbox"/>	<input type="checkbox"/>	<input type="checkbox"/>	10" x 10" 0.054" (1.37mm) 50 ksi (340 MPa) Gusset Plate w/ S/HD15SS Simpson	<input type="checkbox"/>	<input type="checkbox"/>	<input type="checkbox"/>
<input checked="" type="checkbox"/>	S/HD10S Simpson	inside	outside	raised																																		
<input type="checkbox"/>	Fabricated U-shape	<input type="checkbox"/>	<input type="checkbox"/>	<input type="checkbox"/>																																		
<input type="checkbox"/>	6" x 6" 0.054" (1.37mm) 50 ksi (340 MPa) Gusset Plate w/ S/HD15SS Simpson	<input type="checkbox"/>	<input type="checkbox"/>	<input type="checkbox"/>																																		
<input type="checkbox"/>	7" x 9" 0.054" (1.37mm) 50 ksi (340 MPa) Gusset Plate w/ S/HD15SS Simpson	<input type="checkbox"/>	<input type="checkbox"/>	<input type="checkbox"/>																																		
<input type="checkbox"/>	8" x 8" 0.068" (1.73mm) 50 ksi (340 MPa) Gusset Plate w/ S/HD15SS Simpson	<input type="checkbox"/>	<input type="checkbox"/>	<input type="checkbox"/>																																		
<input type="checkbox"/>	8.5" x 10" 0.068" (1.73mm) 50 ksi (340 MPa) Gusset Plate w/ S/HD15SS Simpson	<input type="checkbox"/>	<input type="checkbox"/>	<input type="checkbox"/>																																		
<input type="checkbox"/>	10" x 10" 0.054" (1.37mm) 50 ksi (340 MPa) Gusset Plate w/ S/HD15SS Simpson	<input type="checkbox"/>	<input type="checkbox"/>	<input type="checkbox"/>																																		
TEST PROTOCOL AND DESCRIPTION:	<table border="1" style="width: 100%; border-collapse: collapse;"> <tr><td><input checked="" type="checkbox"/></td><td>Monotonic (Rate of Loading 2.5 mm/min)</td></tr> <tr><td><input type="checkbox"/></td><td>Cyclic (CUREE cyclic protocol)</td></tr> </table>			<input checked="" type="checkbox"/>	Monotonic (Rate of Loading 2.5 mm/min)	<input type="checkbox"/>	Cyclic (CUREE cyclic protocol)																															
<input checked="" type="checkbox"/>	Monotonic (Rate of Loading 2.5 mm/min)																																					
<input type="checkbox"/>	Cyclic (CUREE cyclic protocol)																																					
DATA MEASUREMENTS:	<table border="1" style="width: 100%; border-collapse: collapse;"> <tr><td><input checked="" type="checkbox"/></td><td>Actuator LVDT</td><td><input checked="" type="checkbox"/></td><td>North Uplift</td></tr> <tr><td><input checked="" type="checkbox"/></td><td>North Slip</td><td><input checked="" type="checkbox"/></td><td>South Uplift</td></tr> <tr><td><input checked="" type="checkbox"/></td><td>South Slip</td><td><input checked="" type="checkbox"/></td><td>Top of Wall</td></tr> </table>			<input checked="" type="checkbox"/>	Actuator LVDT	<input checked="" type="checkbox"/>	North Uplift	<input checked="" type="checkbox"/>	North Slip	<input checked="" type="checkbox"/>	South Uplift	<input checked="" type="checkbox"/>	South Slip	<input checked="" type="checkbox"/>	Top of Wall																							
<input checked="" type="checkbox"/>	Actuator LVDT	<input checked="" type="checkbox"/>	North Uplift																																			
<input checked="" type="checkbox"/>	North Slip	<input checked="" type="checkbox"/>	South Uplift																																			
<input checked="" type="checkbox"/>	South Slip	<input checked="" type="checkbox"/>	Top of Wall																																			
	TOTAL: <input type="text" value="6"/>																																					
STRAP WIDTH BEFORE TEST:	<table border="1" style="width: 100%; border-collapse: collapse;"> <tr><td>Front Right</td><td>Front Left, mm</td><td>Back Right, mm</td><td>Back Left, mm</td></tr> <tr><td>63.09</td><td>64.32</td><td>64.24</td><td>63.66</td></tr> <tr><td>63.89</td><td>64.29</td><td>63.97</td><td>64.36</td></tr> <tr><td>64.23</td><td>63.02</td><td>63.51</td><td>64.23</td></tr> <tr><td>AVG</td><td>63.74 mm</td><td>AVG</td><td>63.88 mm</td></tr> <tr><td></td><td></td><td>AVG</td><td>63.91 mm</td></tr> <tr><td></td><td></td><td>AVG</td><td>64.08 mm</td></tr> </table>			Front Right	Front Left, mm	Back Right, mm	Back Left, mm	63.09	64.32	64.24	63.66	63.89	64.29	63.97	64.36	64.23	63.02	63.51	64.23	AVG	63.74 mm	AVG	63.88 mm			AVG	63.91 mm			AVG	64.08 mm							
Front Right	Front Left, mm	Back Right, mm	Back Left, mm																																			
63.09	64.32	64.24	63.66																																			
63.89	64.29	63.97	64.36																																			
64.23	63.02	63.51	64.23																																			
AVG	63.74 mm	AVG	63.88 mm																																			
		AVG	63.91 mm																																			
		AVG	64.08 mm																																			
DATA ACQ. RECORD RATE:	100 scan/sec		MONITOR RATE:																																			
		100 scan/sec																																				
COMMENTS:	<ul style="list-style-type: none"> -Shear anchors torqued for 10 s with impact wrench -Hold down anchors 1/2 turn from finger tight (load cells used on both hold-downs) -Double chord studs used screwed back to back -Square plate washers (2.5"x2.5") used in all top track connections -Regular washers used in all bottom track connections 																																					

Figure E.23: Data sheet for test 14A-C

Test name : 14A-C
 Date tested : July 25, 2007
 Wall Size : 8'x9'
 Strap Size : 2.5"
 Extended Track : yes no
 Holddown : Inside Outside
 Test mode : Cyclic Monotonic

Front side notes: _____

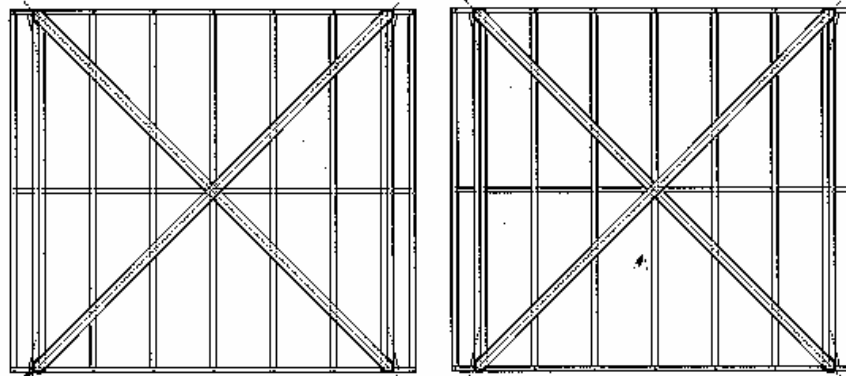

Back side notes: _____

General notes: _____

Track cracked at weld in tension zone on north side, both flanges slight deformations in track in this location and all corners.

Figure E.24: Observations for test 14A-C

Cold Formed Steel Strap Braced Walls McGill University, Montreal																																						
TEST: 16 A-C																																						
RESEARCHER: Gilles Comeau	ASSISTANTS: Kostadin Velchev, Nisreen Bah																																					
DATE: 1-Aug-07	TIME: 12:50PM																																					
DIMENSIONS OF WALL: 8 FT X 8 FT X 6 IN.	INITIAL STRAP SURVEY:		<table style="font-size: small;"> <tr><td>Front</td><td>Right</td><td>Left</td></tr> <tr><td>Back</td><td>Loose</td><td>Loose</td></tr> <tr><td></td><td>Loose</td><td>Loose</td></tr> </table>	Front	Right	Left	Back	Loose	Loose		Loose	Loose																										
Front	Right	Left																																				
Back	Loose	Loose																																				
	Loose	Loose																																				
STRAP FASTENER CONFIGURATION: MFR: McGill																																						
STRAP SIZE:	<table style="font-size: x-small;"> <tr><td><input checked="" type="checkbox"/></td><td>2.5" 0.043" (1.09mm) 33 ksi (230 MPa)</td></tr> <tr><td><input type="checkbox"/></td><td>2.75" 0.054" (1.37mm) 50 ksi (340 MPa)</td></tr> <tr><td><input type="checkbox"/></td><td>4" 0.068" (1.73mm) 50 ksi (340 MPa)</td></tr> <tr><td><input type="checkbox"/></td><td>5" 0.043" (1.09) 33 ksi (230 MPa)</td></tr> <tr><td><input type="checkbox"/></td><td>Reduced section strap -- fuse = 2.5" wide x 30" long -- ends = 3.75" wide 0.043" (1.09mm) 33 ksi (230 MPa)</td></tr> <tr><td><input type="checkbox"/></td><td>Reduced section strap -- fuse = 2.75" wide x 30" long -- ends = 4.25" wide 0.054" (1.37mm) 50 ksi (340 MPa)</td></tr> <tr><td><input type="checkbox"/></td><td>Reduced section strap -- fuse = 4" wide x 30" long -- ends = 6" wide 0.068" (1.73mm) 50 ksi (340 MPa)</td></tr> <tr><td><input type="checkbox"/></td><td>Reduced section strap -- fuse = 2.5" wide x 60" long -- ends = 3.75" wide 0.043" (1.09mm) 33 ksi (230 MPa)</td></tr> <tr><td><input type="checkbox"/></td><td>Reduced section strap -- fuse = 4" wide x 60" long -- ends = 6" wide 0.068" (1.73mm) 50 ksi (340 MPa)</td></tr> </table>			<input checked="" type="checkbox"/>	2.5" 0.043" (1.09mm) 33 ksi (230 MPa)	<input type="checkbox"/>	2.75" 0.054" (1.37mm) 50 ksi (340 MPa)	<input type="checkbox"/>	4" 0.068" (1.73mm) 50 ksi (340 MPa)	<input type="checkbox"/>	5" 0.043" (1.09) 33 ksi (230 MPa)	<input type="checkbox"/>	Reduced section strap -- fuse = 2.5" wide x 30" long -- ends = 3.75" wide 0.043" (1.09mm) 33 ksi (230 MPa)	<input type="checkbox"/>	Reduced section strap -- fuse = 2.75" wide x 30" long -- ends = 4.25" wide 0.054" (1.37mm) 50 ksi (340 MPa)	<input type="checkbox"/>	Reduced section strap -- fuse = 4" wide x 30" long -- ends = 6" wide 0.068" (1.73mm) 50 ksi (340 MPa)	<input type="checkbox"/>	Reduced section strap -- fuse = 2.5" wide x 60" long -- ends = 3.75" wide 0.043" (1.09mm) 33 ksi (230 MPa)	<input type="checkbox"/>	Reduced section strap -- fuse = 4" wide x 60" long -- ends = 6" wide 0.068" (1.73mm) 50 ksi (340 MPa)																	
<input checked="" type="checkbox"/>	2.5" 0.043" (1.09mm) 33 ksi (230 MPa)																																					
<input type="checkbox"/>	2.75" 0.054" (1.37mm) 50 ksi (340 MPa)																																					
<input type="checkbox"/>	4" 0.068" (1.73mm) 50 ksi (340 MPa)																																					
<input type="checkbox"/>	5" 0.043" (1.09) 33 ksi (230 MPa)																																					
<input type="checkbox"/>	Reduced section strap -- fuse = 2.5" wide x 30" long -- ends = 3.75" wide 0.043" (1.09mm) 33 ksi (230 MPa)																																					
<input type="checkbox"/>	Reduced section strap -- fuse = 2.75" wide x 30" long -- ends = 4.25" wide 0.054" (1.37mm) 50 ksi (340 MPa)																																					
<input type="checkbox"/>	Reduced section strap -- fuse = 4" wide x 30" long -- ends = 6" wide 0.068" (1.73mm) 50 ksi (340 MPa)																																					
<input type="checkbox"/>	Reduced section strap -- fuse = 2.5" wide x 60" long -- ends = 3.75" wide 0.043" (1.09mm) 33 ksi (230 MPa)																																					
<input type="checkbox"/>	Reduced section strap -- fuse = 4" wide x 60" long -- ends = 6" wide 0.068" (1.73mm) 50 ksi (340 MPa)																																					
INTERIOR STUDS:	<table style="font-size: x-small;"> <tr><td><input checked="" type="checkbox"/></td><td>3-5/8"Wx1-5/8"Fx1/2"Lip 0.043" (1.09mm) 33ksi (230 Mpa)</td></tr> <tr><td><input type="checkbox"/></td><td>6"Wx1-5/8"Fx1/2"Lip 0.043" (1.09mm) 33ksi (230 Mpa)</td></tr> </table>		<input checked="" type="checkbox"/>	3-5/8"Wx1-5/8"Fx1/2"Lip 0.043" (1.09mm) 33ksi (230 Mpa)	<input type="checkbox"/>	6"Wx1-5/8"Fx1/2"Lip 0.043" (1.09mm) 33ksi (230 Mpa)	STUD SPACING: <input checked="" type="checkbox"/> 16" O.C. Other: _____																															
<input checked="" type="checkbox"/>	3-5/8"Wx1-5/8"Fx1/2"Lip 0.043" (1.09mm) 33ksi (230 Mpa)																																					
<input type="checkbox"/>	6"Wx1-5/8"Fx1/2"Lip 0.043" (1.09mm) 33ksi (230 Mpa)																																					
BACK-TO-BACK CHORD STUDS:	<table style="font-size: x-small;"> <tr><td><input checked="" type="checkbox"/></td><td>3-5/8"Wx1-5/8"Fx1/2"Lip 0.043" (1.09mm) 33ksi (230 Mpa)</td></tr> <tr><td><input type="checkbox"/></td><td>6"Wx1-5/8"Fx1/2"Lip 0.054" (1.37mm) 50ksi (345 Mpa)</td></tr> <tr><td><input type="checkbox"/></td><td>6"Wx1-5/8"Fx1/2"Lip 0.068" (1.73mm) 50ksi (345 Mpa)</td></tr> </table>			<input checked="" type="checkbox"/>	3-5/8"Wx1-5/8"Fx1/2"Lip 0.043" (1.09mm) 33ksi (230 Mpa)	<input type="checkbox"/>	6"Wx1-5/8"Fx1/2"Lip 0.054" (1.37mm) 50ksi (345 Mpa)	<input type="checkbox"/>	6"Wx1-5/8"Fx1/2"Lip 0.068" (1.73mm) 50ksi (345 Mpa)																													
<input checked="" type="checkbox"/>	3-5/8"Wx1-5/8"Fx1/2"Lip 0.043" (1.09mm) 33ksi (230 Mpa)																																					
<input type="checkbox"/>	6"Wx1-5/8"Fx1/2"Lip 0.054" (1.37mm) 50ksi (345 Mpa)																																					
<input type="checkbox"/>	6"Wx1-5/8"Fx1/2"Lip 0.068" (1.73mm) 50ksi (345 Mpa)																																					
CONNECTIONS:	<table style="font-size: x-small;"> <tr><td><input checked="" type="checkbox"/></td><td>Straps</td><td>No.10 gauge 0.75" self-drilling wafer head (mod. Truss) Phillips drive</td></tr> <tr><td><input checked="" type="checkbox"/></td><td>Framing:</td><td>No.8 gauge 0.5" self-drilling wafer head (mod. Truss) Phillips drive</td></tr> <tr><td><input checked="" type="checkbox"/></td><td>Hold downs:</td><td>No.14 gauge 0.1" self-drilling Hex washer head</td></tr> <tr><td><input checked="" type="checkbox"/></td><td>Back-to-Back Chord Studs:</td><td>No.10 gauge 0.75" self-drilling Hex washer head</td></tr> <tr><td><input checked="" type="checkbox"/></td><td>Anchor Rods:</td><td>7/8" A193 Rod</td></tr> <tr><td><input checked="" type="checkbox"/></td><td></td><td>1" A193 Rod</td></tr> <tr><td><input checked="" type="checkbox"/></td><td>Loading Beam:</td><td>A325 3/4" bolts</td></tr> <tr><td><input checked="" type="checkbox"/></td><td>Base:</td><td>A325 3/4" bolts</td></tr> </table>			<input checked="" type="checkbox"/>	Straps	No.10 gauge 0.75" self-drilling wafer head (mod. Truss) Phillips drive	<input checked="" type="checkbox"/>	Framing:	No.8 gauge 0.5" self-drilling wafer head (mod. Truss) Phillips drive	<input checked="" type="checkbox"/>	Hold downs:	No.14 gauge 0.1" self-drilling Hex washer head	<input checked="" type="checkbox"/>	Back-to-Back Chord Studs:	No.10 gauge 0.75" self-drilling Hex washer head	<input checked="" type="checkbox"/>	Anchor Rods:	7/8" A193 Rod	<input checked="" type="checkbox"/>		1" A193 Rod	<input checked="" type="checkbox"/>	Loading Beam:	A325 3/4" bolts	<input checked="" type="checkbox"/>	Base:	A325 3/4" bolts											
<input checked="" type="checkbox"/>	Straps	No.10 gauge 0.75" self-drilling wafer head (mod. Truss) Phillips drive																																				
<input checked="" type="checkbox"/>	Framing:	No.8 gauge 0.5" self-drilling wafer head (mod. Truss) Phillips drive																																				
<input checked="" type="checkbox"/>	Hold downs:	No.14 gauge 0.1" self-drilling Hex washer head																																				
<input checked="" type="checkbox"/>	Back-to-Back Chord Studs:	No.10 gauge 0.75" self-drilling Hex washer head																																				
<input checked="" type="checkbox"/>	Anchor Rods:	7/8" A193 Rod																																				
<input checked="" type="checkbox"/>		1" A193 Rod																																				
<input checked="" type="checkbox"/>	Loading Beam:	A325 3/4" bolts																																				
<input checked="" type="checkbox"/>	Base:	A325 3/4" bolts																																				
TRACK:	<table style="font-size: x-small;"> <tr><td><input checked="" type="checkbox"/></td><td>Regular</td><td><input type="checkbox"/> 6" web</td><td><input type="checkbox"/> 0.043" (1.09mm) 33ksi (230 Mpa)</td></tr> <tr><td><input type="checkbox"/></td><td>Extended</td><td><input checked="" type="checkbox"/> 3 5/8" web</td><td><input checked="" type="checkbox"/> 0.054" (1.37mm) 50ksi (345 Mpa)</td></tr> <tr><td><input type="checkbox"/></td><td>Reinforced</td><td><input type="checkbox"/> 1-1/4" flange</td><td><input type="checkbox"/> 0.068" (1.73mm) 50ksi (345 Mpa)</td></tr> </table>			<input checked="" type="checkbox"/>	Regular	<input type="checkbox"/> 6" web	<input type="checkbox"/> 0.043" (1.09mm) 33ksi (230 Mpa)	<input type="checkbox"/>	Extended	<input checked="" type="checkbox"/> 3 5/8" web	<input checked="" type="checkbox"/> 0.054" (1.37mm) 50ksi (345 Mpa)	<input type="checkbox"/>	Reinforced	<input type="checkbox"/> 1-1/4" flange	<input type="checkbox"/> 0.068" (1.73mm) 50ksi (345 Mpa)																							
<input checked="" type="checkbox"/>	Regular	<input type="checkbox"/> 6" web	<input type="checkbox"/> 0.043" (1.09mm) 33ksi (230 Mpa)																																			
<input type="checkbox"/>	Extended	<input checked="" type="checkbox"/> 3 5/8" web	<input checked="" type="checkbox"/> 0.054" (1.37mm) 50ksi (345 Mpa)																																			
<input type="checkbox"/>	Reinforced	<input type="checkbox"/> 1-1/4" flange	<input type="checkbox"/> 0.068" (1.73mm) 50ksi (345 Mpa)																																			
HOLD DOWNS:	<table style="font-size: x-small;"> <tr><td><input checked="" type="checkbox"/></td><td>S/HD10S Simpson</td><td>inside</td><td>outside</td><td>raised</td></tr> <tr><td><input type="checkbox"/></td><td>Fabricated U-shape</td><td><input checked="" type="checkbox"/></td><td><input type="checkbox"/></td><td><input type="checkbox"/></td></tr> <tr><td><input type="checkbox"/></td><td>6" x 6" 0.054" (1.37mm) 50 ksi (340 MPa) Gusset Plate w/ S/HD15SS Simpson</td><td><input type="checkbox"/></td><td><input type="checkbox"/></td><td><input type="checkbox"/></td></tr> <tr><td><input type="checkbox"/></td><td>7" x 9" 0.054" (1.37mm) 50 ksi (340 MPa) Gusset Plate w/ S/HD15SS Simpson</td><td><input type="checkbox"/></td><td><input type="checkbox"/></td><td><input type="checkbox"/></td></tr> <tr><td><input type="checkbox"/></td><td>8" x 8" 0.068" (1.73mm) 50 ksi (340 MPa) Gusset Plate w/ S/HD15SS Simpson</td><td><input type="checkbox"/></td><td><input type="checkbox"/></td><td><input type="checkbox"/></td></tr> <tr><td><input type="checkbox"/></td><td>8.5" x10" 0.068" (1.73mm) 50 ksi (340 MPa) Gusset Plate w/ S/HD15SS Simpson</td><td><input type="checkbox"/></td><td><input type="checkbox"/></td><td><input type="checkbox"/></td></tr> <tr><td><input type="checkbox"/></td><td>10" x10" 0.054" (1.37mm) 50 ksi (340 MPa) Gusset Plate w/ S/HD15SS Simpson</td><td><input type="checkbox"/></td><td><input type="checkbox"/></td><td><input type="checkbox"/></td></tr> </table>			<input checked="" type="checkbox"/>	S/HD10S Simpson	inside	outside	raised	<input type="checkbox"/>	Fabricated U-shape	<input checked="" type="checkbox"/>	<input type="checkbox"/>	<input type="checkbox"/>	<input type="checkbox"/>	6" x 6" 0.054" (1.37mm) 50 ksi (340 MPa) Gusset Plate w/ S/HD15SS Simpson	<input type="checkbox"/>	<input type="checkbox"/>	<input type="checkbox"/>	<input type="checkbox"/>	7" x 9" 0.054" (1.37mm) 50 ksi (340 MPa) Gusset Plate w/ S/HD15SS Simpson	<input type="checkbox"/>	<input type="checkbox"/>	<input type="checkbox"/>	<input type="checkbox"/>	8" x 8" 0.068" (1.73mm) 50 ksi (340 MPa) Gusset Plate w/ S/HD15SS Simpson	<input type="checkbox"/>	<input type="checkbox"/>	<input type="checkbox"/>	<input type="checkbox"/>	8.5" x10" 0.068" (1.73mm) 50 ksi (340 MPa) Gusset Plate w/ S/HD15SS Simpson	<input type="checkbox"/>	<input type="checkbox"/>	<input type="checkbox"/>	<input type="checkbox"/>	10" x10" 0.054" (1.37mm) 50 ksi (340 MPa) Gusset Plate w/ S/HD15SS Simpson	<input type="checkbox"/>	<input type="checkbox"/>	<input type="checkbox"/>
<input checked="" type="checkbox"/>	S/HD10S Simpson	inside	outside	raised																																		
<input type="checkbox"/>	Fabricated U-shape	<input checked="" type="checkbox"/>	<input type="checkbox"/>	<input type="checkbox"/>																																		
<input type="checkbox"/>	6" x 6" 0.054" (1.37mm) 50 ksi (340 MPa) Gusset Plate w/ S/HD15SS Simpson	<input type="checkbox"/>	<input type="checkbox"/>	<input type="checkbox"/>																																		
<input type="checkbox"/>	7" x 9" 0.054" (1.37mm) 50 ksi (340 MPa) Gusset Plate w/ S/HD15SS Simpson	<input type="checkbox"/>	<input type="checkbox"/>	<input type="checkbox"/>																																		
<input type="checkbox"/>	8" x 8" 0.068" (1.73mm) 50 ksi (340 MPa) Gusset Plate w/ S/HD15SS Simpson	<input type="checkbox"/>	<input type="checkbox"/>	<input type="checkbox"/>																																		
<input type="checkbox"/>	8.5" x10" 0.068" (1.73mm) 50 ksi (340 MPa) Gusset Plate w/ S/HD15SS Simpson	<input type="checkbox"/>	<input type="checkbox"/>	<input type="checkbox"/>																																		
<input type="checkbox"/>	10" x10" 0.054" (1.37mm) 50 ksi (340 MPa) Gusset Plate w/ S/HD15SS Simpson	<input type="checkbox"/>	<input type="checkbox"/>	<input type="checkbox"/>																																		
TEST PROTOCOL AND DESCRIPTION:	<table style="font-size: x-small;"> <tr><td><input type="checkbox"/></td><td>Monotonic (Rate of Loading 2.5 mm/min)</td></tr> <tr><td><input checked="" type="checkbox"/></td><td>Cyclic (CUREE cyclic protocol)</td></tr> </table>			<input type="checkbox"/>	Monotonic (Rate of Loading 2.5 mm/min)	<input checked="" type="checkbox"/>	Cyclic (CUREE cyclic protocol)																															
<input type="checkbox"/>	Monotonic (Rate of Loading 2.5 mm/min)																																					
<input checked="" type="checkbox"/>	Cyclic (CUREE cyclic protocol)																																					
DATA MEASUREMENTS:	<table style="font-size: x-small;"> <tr><td><input checked="" type="checkbox"/></td><td>Actuator LVDT</td><td><input checked="" type="checkbox"/></td><td>North Uplift</td></tr> <tr><td><input checked="" type="checkbox"/></td><td>North Slip</td><td><input checked="" type="checkbox"/></td><td>South Uplift</td></tr> <tr><td><input checked="" type="checkbox"/></td><td>South Slip</td><td><input checked="" type="checkbox"/></td><td>Top of Wall</td></tr> </table>			<input checked="" type="checkbox"/>	Actuator LVDT	<input checked="" type="checkbox"/>	North Uplift	<input checked="" type="checkbox"/>	North Slip	<input checked="" type="checkbox"/>	South Uplift	<input checked="" type="checkbox"/>	South Slip	<input checked="" type="checkbox"/>	Top of Wall																							
<input checked="" type="checkbox"/>	Actuator LVDT	<input checked="" type="checkbox"/>	North Uplift																																			
<input checked="" type="checkbox"/>	North Slip	<input checked="" type="checkbox"/>	South Uplift																																			
<input checked="" type="checkbox"/>	South Slip	<input checked="" type="checkbox"/>	Top of Wall																																			
			TOTAL: <input type="text" value="6"/>																																			
STRAP WIDTH BEFORE TEST:	<table style="font-size: x-small; width: 100%;"> <tr> <td style="width: 25%;">Front Right</td> <td style="width: 25%;">Front Left, mm</td> <td style="width: 25%;">Back Right, mm</td> <td style="width: 25%;">Back Left, mm</td> </tr> <tr> <td><input type="text" value="64.12"/></td> <td><input type="text" value="63.41"/></td> <td><input type="text" value="63.35"/></td> <td><input type="text" value="64.22"/></td> </tr> <tr> <td><input type="text" value="63.7"/></td> <td><input type="text" value="63.90"/></td> <td><input type="text" value="63.91"/></td> <td><input type="text" value="64.16"/></td> </tr> <tr> <td><input type="text" value="63.20"/></td> <td><input type="text" value="64.13"/></td> <td><input type="text" value="64.05"/></td> <td><input type="text" value="63.53"/></td> </tr> <tr> <td>AVG <input type="text" value="63.67"/> mm</td> <td>AVG <input type="text" value="63.81"/> mm</td> <td>AVG <input type="text" value="63.77"/> mm</td> <td>AVG <input type="text" value="63.97"/> mm</td> </tr> </table>			Front Right	Front Left, mm	Back Right, mm	Back Left, mm	<input type="text" value="64.12"/>	<input type="text" value="63.41"/>	<input type="text" value="63.35"/>	<input type="text" value="64.22"/>	<input type="text" value="63.7"/>	<input type="text" value="63.90"/>	<input type="text" value="63.91"/>	<input type="text" value="64.16"/>	<input type="text" value="63.20"/>	<input type="text" value="64.13"/>	<input type="text" value="64.05"/>	<input type="text" value="63.53"/>	AVG <input type="text" value="63.67"/> mm	AVG <input type="text" value="63.81"/> mm	AVG <input type="text" value="63.77"/> mm	AVG <input type="text" value="63.97"/> mm															
Front Right	Front Left, mm	Back Right, mm	Back Left, mm																																			
<input type="text" value="64.12"/>	<input type="text" value="63.41"/>	<input type="text" value="63.35"/>	<input type="text" value="64.22"/>																																			
<input type="text" value="63.7"/>	<input type="text" value="63.90"/>	<input type="text" value="63.91"/>	<input type="text" value="64.16"/>																																			
<input type="text" value="63.20"/>	<input type="text" value="64.13"/>	<input type="text" value="64.05"/>	<input type="text" value="63.53"/>																																			
AVG <input type="text" value="63.67"/> mm	AVG <input type="text" value="63.81"/> mm	AVG <input type="text" value="63.77"/> mm	AVG <input type="text" value="63.97"/> mm																																			
DATA ACQ. RECORD RATE: 100 scan/sec	MONITOR RATE: 100 scan/sec																																					
COMMENTS:	<ul style="list-style-type: none"> -Shear anchors torqued for 10 s with impact wrench -Hold down anchors 1/2 turn from finger tight (load cells used on both hold-downs) -Double chord studs used screwed back to back -Square plate washers (2.5"x2.5") used in all top track connections -Regular washers used in all bottom track connections 																																					

Figure E.25: Data sheet for test 16A-C

Cold Formed Steel Strap Braced Walls McGill University, Montreal			
TEST:		16 B-C	
RESEARCHER:	Gilles Comeau		ASSISTANTS:
		Kostadin Velchev, Nisreen Bah	
DATE:	19-Jul-07		TIME:
		12:00AM	
DIMENSIONS OF WALL:	4 FT X	8 FT X	3 5/8 IN.
INITIAL STRAP SURVEY:	Front	Right	Left
	Back	Loose	Loose
		Loose	Loose
STRAP FASTENER CONFIGURATION: MFR: McGill			
STRAP SIZE:	<input checked="" type="checkbox"/>	2.5" 0.043" (1.09mm) 33 ksi (230 MPa)	
	<input type="checkbox"/>	2.75" 0.054" (1.37mm) 50 ksi (340 MPa)	
	<input type="checkbox"/>	4" 0.068" (1.73mm) 50 ksi (340 MPa)	
	<input type="checkbox"/>	5" 0.043" (1.09) 33 ksi (230 MPa)	
	<input type="checkbox"/>	Reduced section strap -- fuse = 2.5" wide x 30" long -- ends = 3.75" wide 0.043" (1.09mm) 33 ksi (230 MPa)	
	<input type="checkbox"/>	Reduced section strap -- fuse = 2.75" wide x 30" long -- ends = 4.25" wide 0.054" (1.37mm) 50 ksi (340 MPa)	
	<input type="checkbox"/>	Reduced section strap -- fuse = 4" wide x 30" long -- ends = 6" wide 0.068" (1.73mm) 50 ksi (340 MPa)	
	<input type="checkbox"/>	Reduced section strap -- fuse = 2.5" wide x 60" long -- ends = 3.75" wide 0.043" (1.09mm) 33 ksi (230 MPa)	
	<input type="checkbox"/>	Reduced section strap -- fuse = 4" wide x 60" long -- ends = 6" wide 0.068" (1.73mm) 50 ksi (340 MPa)	
INTERIOR STUDS:	<input checked="" type="checkbox"/>	3-5/8"Wx1-5/8"Fx1/2"Lip 0.043" (1.09mm) 33ksi (230 Mpa)	STUD SPACING:
	<input type="checkbox"/>	6"Wx1-5/8"Fx1/2"Lip 0.043" (1.09mm) 33ksi (230 Mpa)	<input checked="" type="checkbox"/>
			16" O.C.
			Other: _____
BACK-TO-BACK CHORD STUDS:	<input checked="" type="checkbox"/>	3-5/8"Wx1-5/8"Fx1/2"Lip 0.043" (1.09mm) 33ksi (230 Mpa)	
	<input type="checkbox"/>	6"Wx1-5/8"Fx1/2"Lip 0.054" (1.37mm) 50ksi (345 Mpa)	
	<input type="checkbox"/>	6"Wx1-5/8"Fx1/2"Lip 0.068" (1.73mm) 50ksi (345 Mpa)	
CONNECTIONS:	Straps	<input checked="" type="checkbox"/> No.10 gauge 0.75" self-drilling wafer head (mod. Truss) Phillips drive	
	Framing:	<input checked="" type="checkbox"/> No.8 gauge 0.5" self-drilling wafer head (mod. Truss) Phillips drive	
	Hold downs:	<input checked="" type="checkbox"/> No.14 gauge 0.1" self-drilling Hex washer head	
	Back-to-Back Chord Studs:	<input checked="" type="checkbox"/> No.10 gauge 0.75" self-drilling Hex washer head	
	Anchor Rods:	<input checked="" type="checkbox"/> 7/8" A193 Rod	
		<input checked="" type="checkbox"/> 1" A193 Rod	
	Loading Beam:	<input checked="" type="checkbox"/> A325 3/4" bolts	4 bolts <input checked="" type="checkbox"/>
	Base:	<input checked="" type="checkbox"/> A325 3/4" bolts	4 bolts <input checked="" type="checkbox"/> 2 Anchor Rods <input checked="" type="checkbox"/>
			2 Anchor Rods <input checked="" type="checkbox"/>
TRACK:	<input checked="" type="checkbox"/>	Regular	<input type="checkbox"/> 6" web
	<input type="checkbox"/>	Extended	<input checked="" type="checkbox"/> 3 5/8" web
	<input type="checkbox"/>	Reinforced	<input type="checkbox"/> 1-1/4" flange
			<input checked="" type="checkbox"/> 0.043" (1.09mm) 33ksi (230 Mpa)
			<input checked="" type="checkbox"/> 0.054" (1.37mm) 50ksi (345 Mpa)
			<input type="checkbox"/> 0.068" (1.73mm) 50ksi (345 Mpa)
HOLD DOWNS:	<input checked="" type="checkbox"/>	S/HD10S Simpson	inside outside raised
	<input type="checkbox"/>	Fabricated U-shape	<input checked="" type="checkbox"/>
	<input type="checkbox"/>	6" x 6" 0.054" (1.37mm) 50 ksi (340 MPa) Gusset Plate w/ S/HD15SS Simpson	<input type="checkbox"/>
	<input type="checkbox"/>	7" x 9" 0.054" (1.37mm) 50 ksi (340 MPa) Gusset Plate w/ S/HD15SS Simpson	<input type="checkbox"/>
	<input type="checkbox"/>	8" x 8" 0.068" (1.73mm) 50 ksi (340 MPa) Gusset Plate w/ S/HD15SS Simpson	<input type="checkbox"/>
	<input type="checkbox"/>	8.5" x10" 0.068" (1.73mm) 50 ksi (340 MPa) Gusset Plate w/ S/HD15SS Simpson	<input type="checkbox"/>
	<input type="checkbox"/>	10" x10" 0.054" (1.37mm) 50 ksi (340 MPa) Gusset Plate w/ S/HD15SS Simpson	<input type="checkbox"/>
TEST PROTOCOL AND DESCRIPTION:	<input type="checkbox"/>	Monotonic (Rate of Loading 2.5 mm/min)	
	<input checked="" type="checkbox"/>	Cyclic (CUREE cyclic protocol)	
DATA MEASUREMENTS:	<input checked="" type="checkbox"/>	Actuator LVDT	<input checked="" type="checkbox"/> North Uplift
	<input checked="" type="checkbox"/>	North Slip	<input checked="" type="checkbox"/> South Uplift
	<input checked="" type="checkbox"/>	South Slip	<input checked="" type="checkbox"/> Top of Wall
			TOTAL: <input type="text" value="6"/>
STRAP WIDTH BEFORE TEST:	Front Right	Front Left, mm	Back Right, mm
	63.34	63.16	63.83
	64.1	64.03	63.88
	63.95	63.98	63.24
	AVG 63.80 mm	AVG 63.72 mm	AVG 63.65 mm
			AVG 63.79 mm
DATA ACQ. RECORD RATE:	100 scan/sec		MONITOR RATE:
			100 scan/sec
COMMENTS:	-Shear anchors torqued for 10 s with impact wrench -Hold down anchors 1/2 turn from finger tight (load cells used on both hold-downs) -Double chord studs used screwed back to back -Square plate washers (2.5"x2.5") used in all top track connections -Regular washers used in all bottom track connections		

Figure E.27: Data sheet for test 16B-C



Light Gauge Steel Frame Strap Braced Shear Wall Testing

Test name : 16B-C
Date tested : 17 July 2017
Wall Size : 4x8'
Strap Size : 2.5"
Extended Track : yes no
Holddown : Inside Outside
Test mode : Cyclic Monotonic

Front side notes:

Straps Yielded

Back side notes:

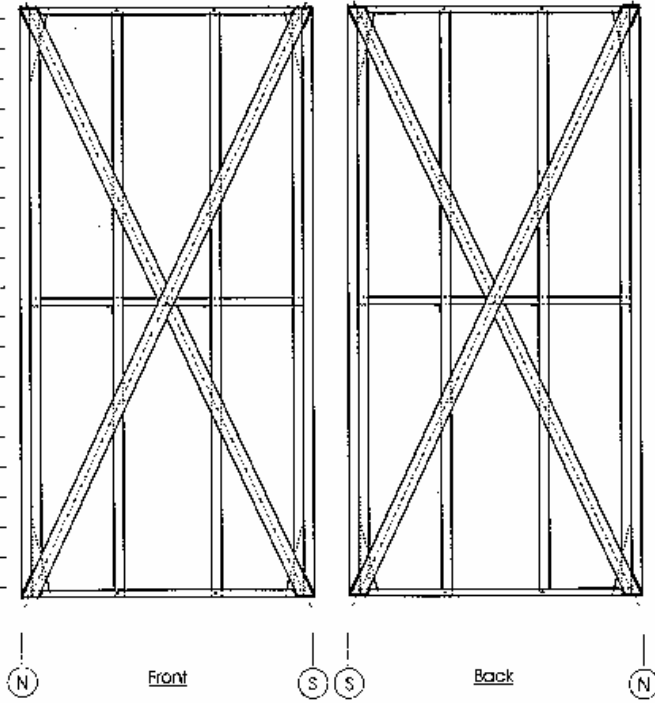

Figure E.28: Observations for test 16B-C

Cold Formed Steel Strap Braced Walls McGill University, Montreal																																													
TEST:		18A-C																																											
RESEARCHER:	Gilles Comeau	ASSISTANTS:	Kostadin Velchev, Nisreen Bah																																										
DATE:	2-Aug-07		TIME:	3:00PM																																									
DIMENSIONS OF WALL:	8 FT X	8 FT X	6 IN.	INITIAL STRAP SURVEY:	Front Back	Right Tight Tight	Left Tight Tight																																						
STRAP FASTENER CONFIGURATION:				MFR: McGill																																									
STRAP SIZE:	<table border="1" style="width:100%; border-collapse: collapse;"> <tr><td><input type="checkbox"/></td><td>2.5" 0.043" (1.09mm) 33 ksi (230 MPa)</td></tr> <tr><td><input checked="" type="checkbox"/></td><td>2.75" 0.054" (1.37mm) 50 ksi (340 MPa)</td></tr> <tr><td><input type="checkbox"/></td><td>4" 0.068" (1.73mm) 50 ksi (340 MPa)</td></tr> <tr><td><input type="checkbox"/></td><td>5" 0.043" (1.09) 33 ksi (230 MPa)</td></tr> <tr><td><input type="checkbox"/></td><td>Reduced section strap -- fuse = 2.5" wide x 30" long -- ends = 3.75" wide 0.043" (1.09mm) 33 ksi (230 MPa)</td></tr> <tr><td><input type="checkbox"/></td><td>Reduced section strap -- fuse = 2.75" wide x 30" long -- ends = 4.25" wide 0.054" (1.37mm) 50 ksi (340 MPa)</td></tr> <tr><td><input type="checkbox"/></td><td>Reduced section strap -- fuse = 4" wide x 30" long -- ends = 6" wide 0.068" (1.73mm) 50 ksi (340 MPa)</td></tr> <tr><td><input type="checkbox"/></td><td>Reduced section strap -- fuse = 2.5" wide x 60" long -- ends = 3.75" wide 0.043" (1.09mm) 33 ksi (230 MPa)</td></tr> <tr><td><input type="checkbox"/></td><td>Reduced section strap -- fuse = 4" wide x 60" long -- ends = 6" wide 0.068" (1.73mm) 50 ksi (340 MPa)</td></tr> </table>			<input type="checkbox"/>	2.5" 0.043" (1.09mm) 33 ksi (230 MPa)	<input checked="" type="checkbox"/>	2.75" 0.054" (1.37mm) 50 ksi (340 MPa)	<input type="checkbox"/>	4" 0.068" (1.73mm) 50 ksi (340 MPa)	<input type="checkbox"/>	5" 0.043" (1.09) 33 ksi (230 MPa)	<input type="checkbox"/>	Reduced section strap -- fuse = 2.5" wide x 30" long -- ends = 3.75" wide 0.043" (1.09mm) 33 ksi (230 MPa)	<input type="checkbox"/>	Reduced section strap -- fuse = 2.75" wide x 30" long -- ends = 4.25" wide 0.054" (1.37mm) 50 ksi (340 MPa)	<input type="checkbox"/>	Reduced section strap -- fuse = 4" wide x 30" long -- ends = 6" wide 0.068" (1.73mm) 50 ksi (340 MPa)	<input type="checkbox"/>	Reduced section strap -- fuse = 2.5" wide x 60" long -- ends = 3.75" wide 0.043" (1.09mm) 33 ksi (230 MPa)	<input type="checkbox"/>	Reduced section strap -- fuse = 4" wide x 60" long -- ends = 6" wide 0.068" (1.73mm) 50 ksi (340 MPa)																								
<input type="checkbox"/>	2.5" 0.043" (1.09mm) 33 ksi (230 MPa)																																												
<input checked="" type="checkbox"/>	2.75" 0.054" (1.37mm) 50 ksi (340 MPa)																																												
<input type="checkbox"/>	4" 0.068" (1.73mm) 50 ksi (340 MPa)																																												
<input type="checkbox"/>	5" 0.043" (1.09) 33 ksi (230 MPa)																																												
<input type="checkbox"/>	Reduced section strap -- fuse = 2.5" wide x 30" long -- ends = 3.75" wide 0.043" (1.09mm) 33 ksi (230 MPa)																																												
<input type="checkbox"/>	Reduced section strap -- fuse = 2.75" wide x 30" long -- ends = 4.25" wide 0.054" (1.37mm) 50 ksi (340 MPa)																																												
<input type="checkbox"/>	Reduced section strap -- fuse = 4" wide x 30" long -- ends = 6" wide 0.068" (1.73mm) 50 ksi (340 MPa)																																												
<input type="checkbox"/>	Reduced section strap -- fuse = 2.5" wide x 60" long -- ends = 3.75" wide 0.043" (1.09mm) 33 ksi (230 MPa)																																												
<input type="checkbox"/>	Reduced section strap -- fuse = 4" wide x 60" long -- ends = 6" wide 0.068" (1.73mm) 50 ksi (340 MPa)																																												
INTERIOR STUDS:	<table border="1" style="width:100%; border-collapse: collapse;"> <tr><td><input type="checkbox"/></td><td>3-5/8"Wx1-5/8"Fx1/2"Lip 0.043" (1.09mm) 33ksi (230 Mpa)</td></tr> <tr><td><input checked="" type="checkbox"/></td><td>6"Wx1-5/8"Fx1/2"Lip 0.043" (1.09mm) 33ksi (230 Mpa)</td></tr> </table>		<input type="checkbox"/>	3-5/8"Wx1-5/8"Fx1/2"Lip 0.043" (1.09mm) 33ksi (230 Mpa)	<input checked="" type="checkbox"/>	6"Wx1-5/8"Fx1/2"Lip 0.043" (1.09mm) 33ksi (230 Mpa)	STUD SPACING:	<table border="1" style="width:100%; border-collapse: collapse;"> <tr><td><input checked="" type="checkbox"/></td><td>16" O.C.</td></tr> <tr><td><input type="checkbox"/></td><td>Other :</td></tr> </table>	<input checked="" type="checkbox"/>	16" O.C.	<input type="checkbox"/>	Other :																																	
<input type="checkbox"/>	3-5/8"Wx1-5/8"Fx1/2"Lip 0.043" (1.09mm) 33ksi (230 Mpa)																																												
<input checked="" type="checkbox"/>	6"Wx1-5/8"Fx1/2"Lip 0.043" (1.09mm) 33ksi (230 Mpa)																																												
<input checked="" type="checkbox"/>	16" O.C.																																												
<input type="checkbox"/>	Other :																																												
BACK-TO-BACK CHORD STUDS:	<table border="1" style="width:100%; border-collapse: collapse;"> <tr><td><input type="checkbox"/></td><td>3-5/8"Wx1-5/8"Fx1/2"Lip 0.043" (1.09mm) 33ksi (230 Mpa)</td></tr> <tr><td><input checked="" type="checkbox"/></td><td>6"Wx1-5/8"Fx1/2"Lip 0.054" (1.37mm) 50ksi (345 Mpa)</td></tr> <tr><td><input type="checkbox"/></td><td>6"Wx1-5/8"Fx1/2"Lip 0.068" (1.73mm) 50ksi (345 Mpa)</td></tr> </table>			<input type="checkbox"/>	3-5/8"Wx1-5/8"Fx1/2"Lip 0.043" (1.09mm) 33ksi (230 Mpa)	<input checked="" type="checkbox"/>	6"Wx1-5/8"Fx1/2"Lip 0.054" (1.37mm) 50ksi (345 Mpa)	<input type="checkbox"/>	6"Wx1-5/8"Fx1/2"Lip 0.068" (1.73mm) 50ksi (345 Mpa)																																				
<input type="checkbox"/>	3-5/8"Wx1-5/8"Fx1/2"Lip 0.043" (1.09mm) 33ksi (230 Mpa)																																												
<input checked="" type="checkbox"/>	6"Wx1-5/8"Fx1/2"Lip 0.054" (1.37mm) 50ksi (345 Mpa)																																												
<input type="checkbox"/>	6"Wx1-5/8"Fx1/2"Lip 0.068" (1.73mm) 50ksi (345 Mpa)																																												
CONNECTIONS:	<table border="1" style="width:100%; border-collapse: collapse;"> <tr><td><input checked="" type="checkbox"/></td><td>Straps</td><td>No.10 gauge 0.75" self-drilling wafer head (mod. Truss) Phillips drive</td></tr> <tr><td><input checked="" type="checkbox"/></td><td>Framing:</td><td>No.8 gauge 0.5" self-drilling wafer head (mod. Truss) Phillips drive</td></tr> <tr><td><input checked="" type="checkbox"/></td><td>Hold downs:</td><td>No.14 gauge 0.1" self-drilling Hex washer head</td></tr> <tr><td><input type="checkbox"/></td><td>Back-to-Back</td><td></td></tr> <tr><td><input checked="" type="checkbox"/></td><td>Chord Studs:</td><td>No.10 gauge 0.75" self-drilling Hex washer head</td></tr> <tr><td><input type="checkbox"/></td><td>Anchor Rods:</td><td>7/8" A193 Rod</td></tr> <tr><td><input checked="" type="checkbox"/></td><td></td><td>1" A193 Rod</td></tr> <tr><td><input checked="" type="checkbox"/></td><td>Loading Beam:</td><td>A325 3/4" bolts</td></tr> <tr><td><input checked="" type="checkbox"/></td><td>Base:</td><td>A325 3/4" bolts</td></tr> </table>			<input checked="" type="checkbox"/>	Straps	No.10 gauge 0.75" self-drilling wafer head (mod. Truss) Phillips drive	<input checked="" type="checkbox"/>	Framing:	No.8 gauge 0.5" self-drilling wafer head (mod. Truss) Phillips drive	<input checked="" type="checkbox"/>	Hold downs:	No.14 gauge 0.1" self-drilling Hex washer head	<input type="checkbox"/>	Back-to-Back		<input checked="" type="checkbox"/>	Chord Studs:	No.10 gauge 0.75" self-drilling Hex washer head	<input type="checkbox"/>	Anchor Rods:	7/8" A193 Rod	<input checked="" type="checkbox"/>		1" A193 Rod	<input checked="" type="checkbox"/>	Loading Beam:	A325 3/4" bolts	<input checked="" type="checkbox"/>	Base:	A325 3/4" bolts															
<input checked="" type="checkbox"/>	Straps	No.10 gauge 0.75" self-drilling wafer head (mod. Truss) Phillips drive																																											
<input checked="" type="checkbox"/>	Framing:	No.8 gauge 0.5" self-drilling wafer head (mod. Truss) Phillips drive																																											
<input checked="" type="checkbox"/>	Hold downs:	No.14 gauge 0.1" self-drilling Hex washer head																																											
<input type="checkbox"/>	Back-to-Back																																												
<input checked="" type="checkbox"/>	Chord Studs:	No.10 gauge 0.75" self-drilling Hex washer head																																											
<input type="checkbox"/>	Anchor Rods:	7/8" A193 Rod																																											
<input checked="" type="checkbox"/>		1" A193 Rod																																											
<input checked="" type="checkbox"/>	Loading Beam:	A325 3/4" bolts																																											
<input checked="" type="checkbox"/>	Base:	A325 3/4" bolts																																											
TRACK:	<table border="1" style="width:100%; border-collapse: collapse;"> <tr><td><input type="checkbox"/></td><td>Regular</td><td><input checked="" type="checkbox"/></td><td>6" web</td><td><input type="checkbox"/></td><td>0.043" (1.09mm) 33ksi (230 Mpa)</td></tr> <tr><td><input checked="" type="checkbox"/></td><td>Extended</td><td><input type="checkbox"/></td><td>3 5/8" web</td><td><input checked="" type="checkbox"/></td><td>0.054" (1.37mm) 50ksi (345 Mpa)</td></tr> <tr><td><input type="checkbox"/></td><td>Reinforced</td><td><input type="checkbox"/></td><td>1-1/4" flange</td><td><input type="checkbox"/></td><td>0.068" (1.73mm) 50ksi (345 Mpa)</td></tr> </table>			<input type="checkbox"/>	Regular	<input checked="" type="checkbox"/>	6" web	<input type="checkbox"/>	0.043" (1.09mm) 33ksi (230 Mpa)	<input checked="" type="checkbox"/>	Extended	<input type="checkbox"/>	3 5/8" web	<input checked="" type="checkbox"/>	0.054" (1.37mm) 50ksi (345 Mpa)	<input type="checkbox"/>	Reinforced	<input type="checkbox"/>	1-1/4" flange	<input type="checkbox"/>	0.068" (1.73mm) 50ksi (345 Mpa)																								
<input type="checkbox"/>	Regular	<input checked="" type="checkbox"/>	6" web	<input type="checkbox"/>	0.043" (1.09mm) 33ksi (230 Mpa)																																								
<input checked="" type="checkbox"/>	Extended	<input type="checkbox"/>	3 5/8" web	<input checked="" type="checkbox"/>	0.054" (1.37mm) 50ksi (345 Mpa)																																								
<input type="checkbox"/>	Reinforced	<input type="checkbox"/>	1-1/4" flange	<input type="checkbox"/>	0.068" (1.73mm) 50ksi (345 Mpa)																																								
HOLD DOWNS:	<table border="1" style="width:100%; border-collapse: collapse;"> <tr><td><input type="checkbox"/></td><td>S/HD10S Simpson</td><td></td><td></td><td></td><td></td></tr> <tr><td><input type="checkbox"/></td><td>Fabricated U-shape</td><td></td><td></td><td></td><td></td></tr> <tr><td><input checked="" type="checkbox"/></td><td>6" x 6" 0.054" (1.37mm) 50 ksi (340 MPa) Gusset Plate w/ S/HD15SS Simpson</td><td></td><td></td><td></td><td></td></tr> <tr><td><input type="checkbox"/></td><td>7" x 9" 0.054" (1.37mm) 50 ksi (340 MPa) Gusset Plate w/ S/HD15SS Simpson</td><td></td><td></td><td></td><td></td></tr> <tr><td><input type="checkbox"/></td><td>8" x 8" 0.068" (1.73mm) 50 ksi (340 MPa) Gusset Plate w/ S/HD15SS Simpson</td><td></td><td></td><td></td><td></td></tr> <tr><td><input type="checkbox"/></td><td>8.5" x10" 0.068" (1.73mm) 50 ksi (340 MPa) Gusset Plate w/ S/HD15SS Simpson</td><td></td><td></td><td></td><td></td></tr> <tr><td><input type="checkbox"/></td><td>10" x10" 0.054" (1.37mm) 50 ksi (340 MPa) Gusset Plate w/ S/HD15SS Simpson</td><td></td><td></td><td></td><td></td></tr> </table>			<input type="checkbox"/>	S/HD10S Simpson					<input type="checkbox"/>	Fabricated U-shape					<input checked="" type="checkbox"/>	6" x 6" 0.054" (1.37mm) 50 ksi (340 MPa) Gusset Plate w/ S/HD15SS Simpson					<input type="checkbox"/>	7" x 9" 0.054" (1.37mm) 50 ksi (340 MPa) Gusset Plate w/ S/HD15SS Simpson					<input type="checkbox"/>	8" x 8" 0.068" (1.73mm) 50 ksi (340 MPa) Gusset Plate w/ S/HD15SS Simpson					<input type="checkbox"/>	8.5" x10" 0.068" (1.73mm) 50 ksi (340 MPa) Gusset Plate w/ S/HD15SS Simpson					<input type="checkbox"/>	10" x10" 0.054" (1.37mm) 50 ksi (340 MPa) Gusset Plate w/ S/HD15SS Simpson				
<input type="checkbox"/>	S/HD10S Simpson																																												
<input type="checkbox"/>	Fabricated U-shape																																												
<input checked="" type="checkbox"/>	6" x 6" 0.054" (1.37mm) 50 ksi (340 MPa) Gusset Plate w/ S/HD15SS Simpson																																												
<input type="checkbox"/>	7" x 9" 0.054" (1.37mm) 50 ksi (340 MPa) Gusset Plate w/ S/HD15SS Simpson																																												
<input type="checkbox"/>	8" x 8" 0.068" (1.73mm) 50 ksi (340 MPa) Gusset Plate w/ S/HD15SS Simpson																																												
<input type="checkbox"/>	8.5" x10" 0.068" (1.73mm) 50 ksi (340 MPa) Gusset Plate w/ S/HD15SS Simpson																																												
<input type="checkbox"/>	10" x10" 0.054" (1.37mm) 50 ksi (340 MPa) Gusset Plate w/ S/HD15SS Simpson																																												
TEST PROTOCOL AND DESCRIPTION:	<table border="1" style="width:100%; border-collapse: collapse;"> <tr><td><input type="checkbox"/></td><td>Monotonic (Rate of Loading 2.5 mm/min)</td></tr> <tr><td><input checked="" type="checkbox"/></td><td>Cyclic (CUREE cyclic protocol)</td></tr> </table>			<input type="checkbox"/>	Monotonic (Rate of Loading 2.5 mm/min)	<input checked="" type="checkbox"/>	Cyclic (CUREE cyclic protocol)																																						
<input type="checkbox"/>	Monotonic (Rate of Loading 2.5 mm/min)																																												
<input checked="" type="checkbox"/>	Cyclic (CUREE cyclic protocol)																																												
DATA MEASUREMENTS:	<table border="1" style="width:100%; border-collapse: collapse;"> <tr><td><input checked="" type="checkbox"/></td><td>Actuator LVDT</td><td><input checked="" type="checkbox"/></td><td>North Uplift</td></tr> <tr><td><input checked="" type="checkbox"/></td><td>North Slip</td><td><input checked="" type="checkbox"/></td><td>South Uplift</td></tr> <tr><td><input checked="" type="checkbox"/></td><td>South Slip</td><td><input checked="" type="checkbox"/></td><td>Top of Wall</td></tr> </table>			<input checked="" type="checkbox"/>	Actuator LVDT	<input checked="" type="checkbox"/>	North Uplift	<input checked="" type="checkbox"/>	North Slip	<input checked="" type="checkbox"/>	South Uplift	<input checked="" type="checkbox"/>	South Slip	<input checked="" type="checkbox"/>	Top of Wall																														
<input checked="" type="checkbox"/>	Actuator LVDT	<input checked="" type="checkbox"/>	North Uplift																																										
<input checked="" type="checkbox"/>	North Slip	<input checked="" type="checkbox"/>	South Uplift																																										
<input checked="" type="checkbox"/>	South Slip	<input checked="" type="checkbox"/>	Top of Wall																																										
			TOTAL: <input type="text" value="6"/>																																										
STRAP WIDTH BEFORE TEST:	<table border="1" style="width:100%; border-collapse: collapse;"> <tr><td></td><td>Front Right</td><td>Front Left, mm</td><td>Back Right, mm</td><td>Back Left, mm</td></tr> <tr><td></td><td>69.73</td><td>70.68</td><td>70.23</td><td>70.38</td></tr> <tr><td></td><td>69.71</td><td>70.32</td><td>70.20</td><td>70.69</td></tr> <tr><td></td><td>70.39</td><td>70.25</td><td>69.92</td><td>70.40</td></tr> <tr><td></td><td>AVG 69.94 mm</td><td>AVG 70.42 mm</td><td>AVG 70.12 mm</td><td>AVG 70.49 mm</td></tr> </table>				Front Right	Front Left, mm	Back Right, mm	Back Left, mm		69.73	70.68	70.23	70.38		69.71	70.32	70.20	70.69		70.39	70.25	69.92	70.40		AVG 69.94 mm	AVG 70.42 mm	AVG 70.12 mm	AVG 70.49 mm																	
	Front Right	Front Left, mm	Back Right, mm	Back Left, mm																																									
	69.73	70.68	70.23	70.38																																									
	69.71	70.32	70.20	70.69																																									
	70.39	70.25	69.92	70.40																																									
	AVG 69.94 mm	AVG 70.42 mm	AVG 70.12 mm	AVG 70.49 mm																																									
DATA ACQ. RECORD RATE:	100 scan/sec		MONITOR RATE:	100 scan/sec																																									
COMMENTS:	<ul style="list-style-type: none"> -Shear anchors torqued for 10 s with impact wrench -Hold down anchors 1/2 turn from finger tight (load cells used on both hold-downs) -Double chord studs used screwed back to back -Square plate washers (2.5"x2.5") used in all top track connections -Regular washers used in all bottom track connections 																																												

Figure E.29: Data sheet for test 18A-C

Cold Formed Steel Strap Braced Walls McGill University, Montreal																																						
TEST: 20A-C																																						
RESEARCHER: Gilles Comeau	ASSISTANTS: Kostadin Velchev, Nisreen Bah																																					
DATE: 24-Jul-07	TIME: 9:30AM																																					
DIMENSIONS OF WALL: 8 FT X 8 FT X 6 IN.	INITIAL STRAP SURVEY:		<table style="font-size: small;"> <tr><td>Front</td><td>Right</td><td>Left</td></tr> <tr><td>Back</td><td>Tight</td><td>Tight</td></tr> <tr><td></td><td>Tight</td><td>Tight</td></tr> </table>	Front	Right	Left	Back	Tight	Tight		Tight	Tight																										
Front	Right	Left																																				
Back	Tight	Tight																																				
	Tight	Tight																																				
STRAP FASTENER CONFIGURATION: MFR: McGill																																						
STRAP SIZE:	<table style="font-size: x-small;"> <tr><td><input type="checkbox"/></td><td>2.5" 0.043" (1.09mm) 33 ksi (230 MPa)</td></tr> <tr><td><input checked="" type="checkbox"/></td><td>2.75" 0.054" (1.37mm) 50 ksi (340 MPa)</td></tr> <tr><td><input type="checkbox"/></td><td>4" 0.068" (1.73mm) 50 ksi (340 MPa)</td></tr> <tr><td><input type="checkbox"/></td><td>5" 0.043" (1.09) 33 ksi (230 MPa)</td></tr> <tr><td><input type="checkbox"/></td><td>Reduced section strap -- fuse = 2.5" wide x 30" long -- ends = 3.75" wide 0.043" (1.09mm) 33 ksi (230 MPa)</td></tr> <tr><td><input type="checkbox"/></td><td>Reduced section strap -- fuse = 2.75" wide x 30" long -- ends = 4.25" wide 0.054" (1.37mm) 50 ksi (340 MPa)</td></tr> <tr><td><input type="checkbox"/></td><td>Reduced section strap -- fuse = 4" wide x 30" long -- ends = 6" wide 0.068" (1.73mm) 50 ksi (340 MPa)</td></tr> <tr><td><input type="checkbox"/></td><td>Reduced section strap -- fuse = 2.5" wide x 60" long -- ends = 3.75" wide 0.043" (1.09mm) 33 ksi (230 MPa)</td></tr> <tr><td><input type="checkbox"/></td><td>Reduced section strap -- fuse = 4" wide x 60" long -- ends = 6" wide 0.068" (1.73mm) 50 ksi (340 MPa)</td></tr> </table>			<input type="checkbox"/>	2.5" 0.043" (1.09mm) 33 ksi (230 MPa)	<input checked="" type="checkbox"/>	2.75" 0.054" (1.37mm) 50 ksi (340 MPa)	<input type="checkbox"/>	4" 0.068" (1.73mm) 50 ksi (340 MPa)	<input type="checkbox"/>	5" 0.043" (1.09) 33 ksi (230 MPa)	<input type="checkbox"/>	Reduced section strap -- fuse = 2.5" wide x 30" long -- ends = 3.75" wide 0.043" (1.09mm) 33 ksi (230 MPa)	<input type="checkbox"/>	Reduced section strap -- fuse = 2.75" wide x 30" long -- ends = 4.25" wide 0.054" (1.37mm) 50 ksi (340 MPa)	<input type="checkbox"/>	Reduced section strap -- fuse = 4" wide x 30" long -- ends = 6" wide 0.068" (1.73mm) 50 ksi (340 MPa)	<input type="checkbox"/>	Reduced section strap -- fuse = 2.5" wide x 60" long -- ends = 3.75" wide 0.043" (1.09mm) 33 ksi (230 MPa)	<input type="checkbox"/>	Reduced section strap -- fuse = 4" wide x 60" long -- ends = 6" wide 0.068" (1.73mm) 50 ksi (340 MPa)																	
<input type="checkbox"/>	2.5" 0.043" (1.09mm) 33 ksi (230 MPa)																																					
<input checked="" type="checkbox"/>	2.75" 0.054" (1.37mm) 50 ksi (340 MPa)																																					
<input type="checkbox"/>	4" 0.068" (1.73mm) 50 ksi (340 MPa)																																					
<input type="checkbox"/>	5" 0.043" (1.09) 33 ksi (230 MPa)																																					
<input type="checkbox"/>	Reduced section strap -- fuse = 2.5" wide x 30" long -- ends = 3.75" wide 0.043" (1.09mm) 33 ksi (230 MPa)																																					
<input type="checkbox"/>	Reduced section strap -- fuse = 2.75" wide x 30" long -- ends = 4.25" wide 0.054" (1.37mm) 50 ksi (340 MPa)																																					
<input type="checkbox"/>	Reduced section strap -- fuse = 4" wide x 30" long -- ends = 6" wide 0.068" (1.73mm) 50 ksi (340 MPa)																																					
<input type="checkbox"/>	Reduced section strap -- fuse = 2.5" wide x 60" long -- ends = 3.75" wide 0.043" (1.09mm) 33 ksi (230 MPa)																																					
<input type="checkbox"/>	Reduced section strap -- fuse = 4" wide x 60" long -- ends = 6" wide 0.068" (1.73mm) 50 ksi (340 MPa)																																					
INTERIOR STUDS:	<table style="font-size: x-small;"> <tr><td><input type="checkbox"/></td><td>3-5/8"Wx1-5/8"Fx1/2"Lip 0.043" (1.09mm) 33ksi (230 Mpa)</td></tr> <tr><td><input checked="" type="checkbox"/></td><td>6"Wx1-5/8"Fx1/2"Lip 0.043" (1.09mm) 33ksi (230 Mpa)</td></tr> </table>		<input type="checkbox"/>	3-5/8"Wx1-5/8"Fx1/2"Lip 0.043" (1.09mm) 33ksi (230 Mpa)	<input checked="" type="checkbox"/>	6"Wx1-5/8"Fx1/2"Lip 0.043" (1.09mm) 33ksi (230 Mpa)	STUD SPACING: <input checked="" type="checkbox"/> 16" O.C. Other: _____																															
<input type="checkbox"/>	3-5/8"Wx1-5/8"Fx1/2"Lip 0.043" (1.09mm) 33ksi (230 Mpa)																																					
<input checked="" type="checkbox"/>	6"Wx1-5/8"Fx1/2"Lip 0.043" (1.09mm) 33ksi (230 Mpa)																																					
BACK-TO-BACK CHORD STUDS:	<table style="font-size: x-small;"> <tr><td><input type="checkbox"/></td><td>3-5/8"Wx1-5/8"Fx1/2"Lip 0.043" (1.09mm) 33ksi (230 Mpa)</td></tr> <tr><td><input checked="" type="checkbox"/></td><td>6"Wx1-5/8"Fx1/2"Lip 0.054" (1.37mm) 50ksi (345 Mpa)</td></tr> <tr><td><input type="checkbox"/></td><td>6"Wx1-5/8"Fx1/2"Lip 0.068" (1.73mm) 50ksi (345 Mpa)</td></tr> </table>			<input type="checkbox"/>	3-5/8"Wx1-5/8"Fx1/2"Lip 0.043" (1.09mm) 33ksi (230 Mpa)	<input checked="" type="checkbox"/>	6"Wx1-5/8"Fx1/2"Lip 0.054" (1.37mm) 50ksi (345 Mpa)	<input type="checkbox"/>	6"Wx1-5/8"Fx1/2"Lip 0.068" (1.73mm) 50ksi (345 Mpa)																													
<input type="checkbox"/>	3-5/8"Wx1-5/8"Fx1/2"Lip 0.043" (1.09mm) 33ksi (230 Mpa)																																					
<input checked="" type="checkbox"/>	6"Wx1-5/8"Fx1/2"Lip 0.054" (1.37mm) 50ksi (345 Mpa)																																					
<input type="checkbox"/>	6"Wx1-5/8"Fx1/2"Lip 0.068" (1.73mm) 50ksi (345 Mpa)																																					
CONNECTIONS:	<table style="font-size: x-small;"> <tr><td>Straps</td><td><input checked="" type="checkbox"/></td><td>No.10 gauge 0.75" self-drilling wafer head (mod. Truss) Phillips drive</td></tr> <tr><td></td><td><input checked="" type="checkbox"/></td><td>1/8" fillet weld</td></tr> <tr><td>Framing:</td><td><input checked="" type="checkbox"/></td><td>No.8 gauge 0.5" self-drilling wafer head (mod. Truss) Phillips drive</td></tr> <tr><td>Hold downs:</td><td><input checked="" type="checkbox"/></td><td>No.14 gauge 1" self-drilling Hex washer head</td></tr> <tr><td>Back-to-Back Chord Studs:</td><td><input checked="" type="checkbox"/></td><td>No.10 gauge 0.75" self-drilling wafer head (mod. Truss) Phillips drive</td></tr> <tr><td>Anchor Rods:</td><td><input type="checkbox"/></td><td>7/8" A193 Rod</td></tr> <tr><td></td><td><input checked="" type="checkbox"/></td><td>1" A193 Rod</td></tr> <tr><td>Loading Beam:</td><td><input checked="" type="checkbox"/></td><td>A325 3/4" bolts</td></tr> <tr><td>Base:</td><td><input checked="" type="checkbox"/></td><td>A325 3/4" bolts</td></tr> </table>			Straps	<input checked="" type="checkbox"/>	No.10 gauge 0.75" self-drilling wafer head (mod. Truss) Phillips drive		<input checked="" type="checkbox"/>	1/8" fillet weld	Framing:	<input checked="" type="checkbox"/>	No.8 gauge 0.5" self-drilling wafer head (mod. Truss) Phillips drive	Hold downs:	<input checked="" type="checkbox"/>	No.14 gauge 1" self-drilling Hex washer head	Back-to-Back Chord Studs:	<input checked="" type="checkbox"/>	No.10 gauge 0.75" self-drilling wafer head (mod. Truss) Phillips drive	Anchor Rods:	<input type="checkbox"/>	7/8" A193 Rod		<input checked="" type="checkbox"/>	1" A193 Rod	Loading Beam:	<input checked="" type="checkbox"/>	A325 3/4" bolts	Base:	<input checked="" type="checkbox"/>	A325 3/4" bolts								
Straps	<input checked="" type="checkbox"/>	No.10 gauge 0.75" self-drilling wafer head (mod. Truss) Phillips drive																																				
	<input checked="" type="checkbox"/>	1/8" fillet weld																																				
Framing:	<input checked="" type="checkbox"/>	No.8 gauge 0.5" self-drilling wafer head (mod. Truss) Phillips drive																																				
Hold downs:	<input checked="" type="checkbox"/>	No.14 gauge 1" self-drilling Hex washer head																																				
Back-to-Back Chord Studs:	<input checked="" type="checkbox"/>	No.10 gauge 0.75" self-drilling wafer head (mod. Truss) Phillips drive																																				
Anchor Rods:	<input type="checkbox"/>	7/8" A193 Rod																																				
	<input checked="" type="checkbox"/>	1" A193 Rod																																				
Loading Beam:	<input checked="" type="checkbox"/>	A325 3/4" bolts																																				
Base:	<input checked="" type="checkbox"/>	A325 3/4" bolts																																				
TRACK:	<table style="font-size: x-small;"> <tr><td><input checked="" type="checkbox"/></td><td>Regular</td><td><input checked="" type="checkbox"/></td><td>6" web</td><td><input type="checkbox"/></td><td>0.043" (1.09mm) 33ksi (230 Mpa)</td></tr> <tr><td></td><td>Extended</td><td><input type="checkbox"/></td><td>3 5/8" web</td><td><input type="checkbox"/></td><td>0.054" (1.37mm) 50ksi (345 Mpa)</td></tr> <tr><td></td><td>Reinforced</td><td><input type="checkbox"/></td><td>1-1/4" flange</td><td><input checked="" type="checkbox"/></td><td>0.068" (1.73mm) 50ksi (345 Mpa)</td></tr> </table>			<input checked="" type="checkbox"/>	Regular	<input checked="" type="checkbox"/>	6" web	<input type="checkbox"/>	0.043" (1.09mm) 33ksi (230 Mpa)		Extended	<input type="checkbox"/>	3 5/8" web	<input type="checkbox"/>	0.054" (1.37mm) 50ksi (345 Mpa)		Reinforced	<input type="checkbox"/>	1-1/4" flange	<input checked="" type="checkbox"/>	0.068" (1.73mm) 50ksi (345 Mpa)																	
<input checked="" type="checkbox"/>	Regular	<input checked="" type="checkbox"/>	6" web	<input type="checkbox"/>	0.043" (1.09mm) 33ksi (230 Mpa)																																	
	Extended	<input type="checkbox"/>	3 5/8" web	<input type="checkbox"/>	0.054" (1.37mm) 50ksi (345 Mpa)																																	
	Reinforced	<input type="checkbox"/>	1-1/4" flange	<input checked="" type="checkbox"/>	0.068" (1.73mm) 50ksi (345 Mpa)																																	
HOLD DOWNS:	<table style="font-size: x-small;"> <tr><td><input type="checkbox"/></td><td>S/HD10S Simpson</td><td>inside</td><td>outside</td><td>raised</td></tr> <tr><td><input checked="" type="checkbox"/></td><td>Fabricated U-shape</td><td></td><td></td><td></td></tr> <tr><td></td><td>6" x 6" 0.054" (1.37mm) 50 ksi (340 MPa) Gusset Plate w/ S/HD15S Simpson</td><td><input checked="" type="checkbox"/></td><td></td><td></td></tr> <tr><td></td><td>7" x 9" 0.054" (1.37mm) 50 ksi (340 MPa) Gusset Plate w/ S/HD15S Simpson</td><td></td><td></td><td></td></tr> <tr><td></td><td>8" x 8" 0.068" (1.73mm) 50 ksi (340 MPa) Gusset Plate w/ S/HD15S Simpson</td><td></td><td></td><td></td></tr> <tr><td></td><td>8.5" x10" 0.068" (1.73mm) 50 ksi (340 MPa) Gusset Plate w/ S/HD15S Simpson</td><td></td><td></td><td></td></tr> <tr><td></td><td>10" x10" 0.054" (1.37mm) 50 ksi (340 MPa) Gusset Plate w/ S/HD15S Simpson</td><td></td><td></td><td></td></tr> </table>			<input type="checkbox"/>	S/HD10S Simpson	inside	outside	raised	<input checked="" type="checkbox"/>	Fabricated U-shape					6" x 6" 0.054" (1.37mm) 50 ksi (340 MPa) Gusset Plate w/ S/HD15S Simpson	<input checked="" type="checkbox"/>				7" x 9" 0.054" (1.37mm) 50 ksi (340 MPa) Gusset Plate w/ S/HD15S Simpson					8" x 8" 0.068" (1.73mm) 50 ksi (340 MPa) Gusset Plate w/ S/HD15S Simpson					8.5" x10" 0.068" (1.73mm) 50 ksi (340 MPa) Gusset Plate w/ S/HD15S Simpson					10" x10" 0.054" (1.37mm) 50 ksi (340 MPa) Gusset Plate w/ S/HD15S Simpson			
<input type="checkbox"/>	S/HD10S Simpson	inside	outside	raised																																		
<input checked="" type="checkbox"/>	Fabricated U-shape																																					
	6" x 6" 0.054" (1.37mm) 50 ksi (340 MPa) Gusset Plate w/ S/HD15S Simpson	<input checked="" type="checkbox"/>																																				
	7" x 9" 0.054" (1.37mm) 50 ksi (340 MPa) Gusset Plate w/ S/HD15S Simpson																																					
	8" x 8" 0.068" (1.73mm) 50 ksi (340 MPa) Gusset Plate w/ S/HD15S Simpson																																					
	8.5" x10" 0.068" (1.73mm) 50 ksi (340 MPa) Gusset Plate w/ S/HD15S Simpson																																					
	10" x10" 0.054" (1.37mm) 50 ksi (340 MPa) Gusset Plate w/ S/HD15S Simpson																																					
TEST PROTOCOL AND DESCRIPTION:	<table style="font-size: x-small;"> <tr><td><input type="checkbox"/></td><td>Monotonic (Rate of Loading 2.5 mm/min)</td></tr> <tr><td><input checked="" type="checkbox"/></td><td>Cyclic (CUREE cyclic protocol)</td></tr> </table>			<input type="checkbox"/>	Monotonic (Rate of Loading 2.5 mm/min)	<input checked="" type="checkbox"/>	Cyclic (CUREE cyclic protocol)																															
<input type="checkbox"/>	Monotonic (Rate of Loading 2.5 mm/min)																																					
<input checked="" type="checkbox"/>	Cyclic (CUREE cyclic protocol)																																					
LVDT MEASUREMENTS:	<table style="font-size: x-small;"> <tr><td><input checked="" type="checkbox"/></td><td>Actuator LVDT</td><td><input checked="" type="checkbox"/></td><td>North Uplift</td></tr> <tr><td><input checked="" type="checkbox"/></td><td>North Slip</td><td><input checked="" type="checkbox"/></td><td>South Uplift</td></tr> <tr><td><input checked="" type="checkbox"/></td><td>South Slip</td><td><input checked="" type="checkbox"/></td><td>Top of Wall</td></tr> </table>			<input checked="" type="checkbox"/>	Actuator LVDT	<input checked="" type="checkbox"/>	North Uplift	<input checked="" type="checkbox"/>	North Slip	<input checked="" type="checkbox"/>	South Uplift	<input checked="" type="checkbox"/>	South Slip	<input checked="" type="checkbox"/>	Top of Wall																							
<input checked="" type="checkbox"/>	Actuator LVDT	<input checked="" type="checkbox"/>	North Uplift																																			
<input checked="" type="checkbox"/>	North Slip	<input checked="" type="checkbox"/>	South Uplift																																			
<input checked="" type="checkbox"/>	South Slip	<input checked="" type="checkbox"/>	Top of Wall																																			
TOTAL: <input type="text" value="6"/>																																						
STRAP WIDTH BEFORE TEST:	<table style="font-size: x-small; width: 100%;"> <tr> <td>Front Right</td> <td>Front Left, mm</td> <td>Back Right, mm</td> <td>Back Left, mm</td> </tr> <tr> <td>70.79</td> <td>70.68</td> <td>70.06</td> <td>70.82</td> </tr> <tr> <td>70.19</td> <td>70.32</td> <td>70.08</td> <td>70.06</td> </tr> <tr> <td>70.51</td> <td>70.15</td> <td>70.53</td> <td>70.14</td> </tr> <tr> <td>AVG <input type="text" value="70.50"/> mm</td> <td>AVG <input type="text" value="70.38"/> mm</td> <td>AVG <input type="text" value="70.22"/> mm</td> <td>AVG <input type="text" value="70.34"/> mm</td> </tr> </table>			Front Right	Front Left, mm	Back Right, mm	Back Left, mm	70.79	70.68	70.06	70.82	70.19	70.32	70.08	70.06	70.51	70.15	70.53	70.14	AVG <input type="text" value="70.50"/> mm	AVG <input type="text" value="70.38"/> mm	AVG <input type="text" value="70.22"/> mm	AVG <input type="text" value="70.34"/> mm															
Front Right	Front Left, mm	Back Right, mm	Back Left, mm																																			
70.79	70.68	70.06	70.82																																			
70.19	70.32	70.08	70.06																																			
70.51	70.15	70.53	70.14																																			
AVG <input type="text" value="70.50"/> mm	AVG <input type="text" value="70.38"/> mm	AVG <input type="text" value="70.22"/> mm	AVG <input type="text" value="70.34"/> mm																																			
DATA ACQ. RECORD RATE: 100 scan/sec	MONITOR RATE: 100 scan/sec																																					
COMMENTS: <ul style="list-style-type: none"> -Shear anchors torqued for 10 s with impact wrench -Hold down anchors 1/2 turn from finger tight(top), load cells used on both bottom hold-downs -Double chord studs used screwed back to back -Square plate washers (2.5"x2.5") used in all top track connections -Regular washers used in all bottom track connections 																																						

Figure E.31: Data sheet for test 20A-C



Cold Formed Steel Frame Strap Braced, Shear Wall Testing

Test name : 20A-C
 Date tested : July 24, 2007
 Wall Size : 8x8'
 Strap Size : 2.75"
 Extended Track : yes no
 Holddown : Inside Outside
 Test mode : Cyclic Monotonic

Front side notes:

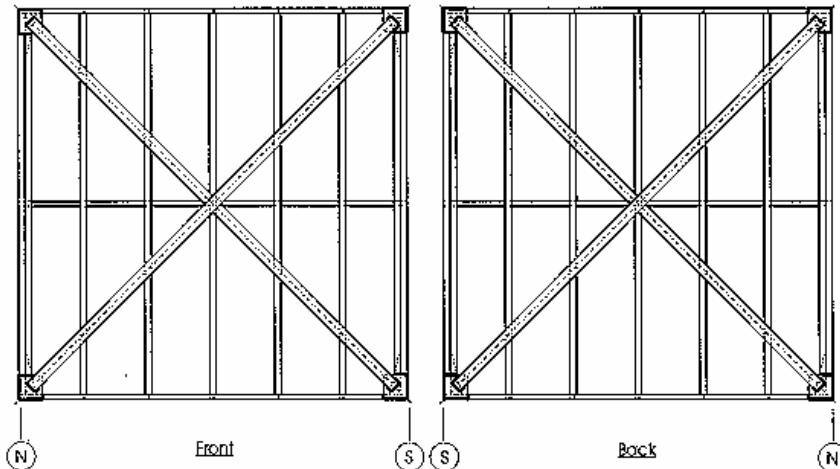

Back side notes:

General notes: *screws through push straps @ interior stud locations*
Test went well!
Full strap yielding

Figure E.32: Observations for test 20A-C

Cold Formed Steel Strap Braced Walls			
McGill University, Montreal			
TEST: 20B-C			
RESEARCHER: Gilles Comeau		ASSISTANTS: Kostadin Velchev, Nisreen Bah	
DATE: 18-Jul-07		TIME: 2:00PM	
DIMENSIONS OF WALL: 2 FT X 8 FT X 6 IN.		INITIAL STRAP SURVEY: Front Right, Back Left, Tight, Loose	
STRAP FASTENER CONFIGURATION: MFR: McGill			
STRAP SIZE:			
<input checked="" type="checkbox"/>	2.5" 0.043" (1.09mm) 33 ksi (230 MPa)		
<input type="checkbox"/>	2.75" 0.054" (1.37mm) 50 ksi (340 MPa)		
<input type="checkbox"/>	4" 0.068" (1.73mm) 50 ksi (340 MPa)		
<input type="checkbox"/>	5" 0.043" (1.09) 33 ksi (230 MPa)		
<input type="checkbox"/>	Reduced section strap -- fuse = 2.5" wide x 30" long -- ends = 3.75" wide 0.043" (1.09mm) 33 ksi (230 MPa)		
<input type="checkbox"/>	Reduced section strap -- fuse = 2.75" wide x 30" long -- ends = 4.25" wide 0.054" (1.37mm) 50 ksi (340 MPa)		
<input type="checkbox"/>	Reduced section strap -- fuse = 4" wide x 30" long -- ends = 6" wide 0.068" (1.73mm) 50 ksi (340 MPa)		
<input type="checkbox"/>	Reduced section strap -- fuse = 2.5" wide x 60" long -- ends = 3.75" wide 0.043" (1.09mm) 33 ksi (230 MPa)		
<input type="checkbox"/>	Reduced section strap -- fuse = 4" wide x 60" long -- ends = 6" wide 0.068" (1.73mm) 50 ksi (340 MPa)		
INTERIOR STUDS:			
<input type="checkbox"/>	3-5/8"Wx1-5/8"Fx1/2"Lip 0.043" (1.09mm) 33ksi (230 Mpa)		STUD SPACING: <input checked="" type="checkbox"/> 16" O.C.
<input checked="" type="checkbox"/>	6"Wx1-5/8"Fx1/2"Lip 0.043" (1.09mm) 33ksi (230 Mpa)		<input type="checkbox"/> Other :
BACK-TO-BACK CHORD STUDS:			
<input type="checkbox"/>	3-5/8"Wx1-5/8"Fx1/2"Lip 0.043" (1.09mm) 33ksi (230 Mpa)		
<input checked="" type="checkbox"/>	6"Wx1-5/8"Fx1/2"Lip 0.054" (1.37mm) 50ksi (345 Mpa)		
<input type="checkbox"/>	6"Wx1-5/8"Fx1/2"Lip 0.068" (1.73mm) 50ksi (345 Mpa)		
CONNECTIONS:			
Straps		<input type="checkbox"/> No.10 gauge 0.75" self-drilling wafer head (mod. Truss) Phillips drive	
<input checked="" type="checkbox"/>		<input type="checkbox"/> 1/8" fillet weld	
Framing:		<input checked="" type="checkbox"/> No.8 gauge 0.5" self-drilling wafer head (mod. Truss) Phillips drive	
<input type="checkbox"/>		<input type="checkbox"/> No.14 gauge 1" self-drilling Hex washer head	
Hold downs:		<input type="checkbox"/> No.10 gauge 0.75" self-drilling wafer head (mod. Truss) Phillips drive	
Back-to-Back Chord Studs:		<input checked="" type="checkbox"/> 7/8" A193 Rod	
<input type="checkbox"/>		<input type="checkbox"/> 1" A193 Rod	
Anchor Rods:		<input checked="" type="checkbox"/> A325 3/4" bolts	
<input type="checkbox"/>		<input type="checkbox"/> A325 3/4" bolts	
Loading Beam:		<input checked="" type="checkbox"/> 1 bolts	
<input type="checkbox"/>		<input type="checkbox"/> 2 Anchor Rods	
Base:		<input checked="" type="checkbox"/> 1 bolts	
<input type="checkbox"/>		<input type="checkbox"/> 2 Anchor Rods	
TRACK:			
<input checked="" type="checkbox"/>	Regular	<input checked="" type="checkbox"/> 6" web	<input type="checkbox"/> 0.043" (1.09mm) 33ksi (230 Mpa)
<input type="checkbox"/>	Extended	<input type="checkbox"/> 3 5/8" web	<input type="checkbox"/> 0.054" (1.37mm) 50ksi (345 Mpa)
<input type="checkbox"/>	Reinforced	<input type="checkbox"/> 1-1/4" flange	<input checked="" type="checkbox"/> 0.068" (1.73mm) 50ksi (345 Mpa)
HOLD DOWNS:			
<input type="checkbox"/>	S/HD10S Simpson	inside outside raised	
<input type="checkbox"/>	Fabricated U-shape		
<input checked="" type="checkbox"/>	6" x 6" 0.054" (1.37mm) 50 ksi (340 MPa) Gusset Plate w/ S/HD15S Simpson	<input checked="" type="checkbox"/>	
<input type="checkbox"/>	7" x 9" 0.054" (1.37mm) 50 ksi (340 MPa) Gusset Plate w/ S/HD15S Simpson		
<input type="checkbox"/>	8" x 8" 0.068" (1.73mm) 50 ksi (340 MPa) Gusset Plate w/ S/HD15S Simpson		
<input type="checkbox"/>	8.5" x 10" 0.068" (1.73mm) 50 ksi (340 MPa) Gusset Plate w/ S/HD15S Simpson		
<input type="checkbox"/>	10" x 10" 0.054" (1.37mm) 50 ksi (340 MPa) Gusset Plate w/ S/HD15S Simpson		
TEST PROTOCOL AND DESCRIPTION:			
<input type="checkbox"/>	Monotonic (Rate of Loading 2.5 mm/min)		
<input checked="" type="checkbox"/>	Cyclic (CUREE cyclic protocol)		
LVDT MEASUREMENTS:			
<input checked="" type="checkbox"/>	Actuator LVDT	<input checked="" type="checkbox"/>	North Uplift
<input checked="" type="checkbox"/>	North Slip	<input checked="" type="checkbox"/>	South Uplift
<input checked="" type="checkbox"/>	South Slip	<input checked="" type="checkbox"/>	Top of Wall
			TOTAL: <input type="text" value="6"/>
STRAP WIDTH BEFORE TEST:			
	Front Right	Front Left, mm	Back Right, mm
	70.38	70.21	69.84
	70.31	70.35	70.00
	70.50	70.55	70.53
	AVG 70.40 mm	AVG 70.37 mm	AVG 70.12 mm
			Back Left, mm
			70.01
			70.29
			70.65
			AVG 70.32 mm
DATA ACQ. RECORD RATE: 100 scan/sec			
MONITOR RATE: 100 scan/sec			
COMMENTS:			
-Shear anchors torqued for 10 s with impact wrench			
-Hold down anchors 1/2 turn from finger tight/top, load cells used on both bottom hold-downs			
-Double chord studs used screwed back to back			
-Square plate washers (2.5"x2.5") used in all top track connections			
-Regular washers used in all bottom track connections			

Figure E.33: Data sheet for test 20B-C



Light Gauge Steel Frame Strap Braced Shear Wall Testing

Front side notes: _____

No load cells used at
bottom hd location
- one comp @ base A (125mm)
was cut off because
excavator ran out of
stroke

5 straps yielded

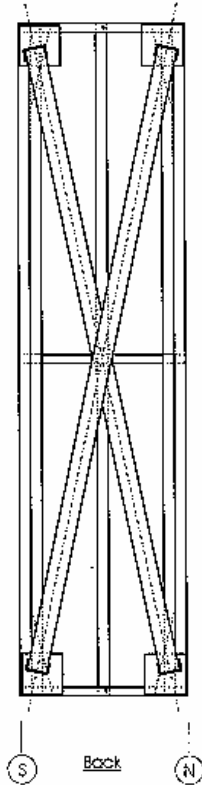
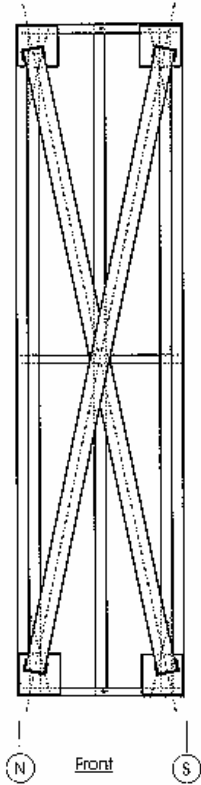

Test name : 20B-C
Date tested : 18 July 01
Wall Size : 2x8
Strap Size : 2.75"
Extended track : yes no
Holddown : Inside Outside
Test mode : Cyclic Monotonic

Back side notes: _____

Figure E.34: Observations for test 20B-C

Cold Formed Steel Strap Braced Walls McGill University, Montreal																																							
TEST:		22A-C																																					
RESEARCHER:	Gilles Comeau		ASSISTANTS:	Kostadin Velchev, Nisreen Bah																																			
DATE:	1-Aug-07		TIME:	12:30PM																																			
DIMENSIONS OF WALL:	8 FT X	8 FT X	6 IN.	INITIAL STRAP SURVEY:	Front Right Back Left Tight Tight Tight Tight																																		
STRAP FASTENER CONFIGURATION:				MFR: McGill																																			
STRAP SIZE:	<table border="1" style="width:100%; border-collapse: collapse;"> <tr><td><input type="checkbox"/></td><td>2.5" 0.043" (1.09mm) 33 ksi (230 MPa)</td></tr> <tr><td><input type="checkbox"/></td><td>2.75" 0.054" (1.37mm) 50 ksi (340 MPa)</td></tr> <tr><td><input checked="" type="checkbox"/></td><td>4" 0.068" (1.73mm) 50 ksi (340 MPa)</td></tr> <tr><td><input type="checkbox"/></td><td>5" 0.043" (1.09) 33 ksi (230 MPa)</td></tr> <tr><td><input type="checkbox"/></td><td>Reduced section strap -- fuse = 2.5" wide x 30" long -- ends = 3.75" wide 0.043" (1.09mm) 33 ksi (230 MPa)</td></tr> <tr><td><input type="checkbox"/></td><td>Reduced section strap -- fuse = 2.75" wide x 30" long -- ends = 4.25" wide 0.054" (1.37mm) 50 ksi (340 MPa)</td></tr> <tr><td><input type="checkbox"/></td><td>Reduced section strap -- fuse = 4" wide x 30" long -- ends = 6" wide 0.068" (1.73mm) 50 ksi (340 MPa)</td></tr> <tr><td><input type="checkbox"/></td><td>Reduced section strap -- fuse = 2.5" wide x 60" long -- ends = 3.75" wide 0.043" (1.09mm) 33 ksi (230 MPa)</td></tr> <tr><td><input type="checkbox"/></td><td>Reduced section strap -- fuse = 4" wide x 60" long -- ends = 6" wide 0.068" (1.73mm) 50 ksi (340 MPa)</td></tr> </table>				<input type="checkbox"/>	2.5" 0.043" (1.09mm) 33 ksi (230 MPa)	<input type="checkbox"/>	2.75" 0.054" (1.37mm) 50 ksi (340 MPa)	<input checked="" type="checkbox"/>	4" 0.068" (1.73mm) 50 ksi (340 MPa)	<input type="checkbox"/>	5" 0.043" (1.09) 33 ksi (230 MPa)	<input type="checkbox"/>	Reduced section strap -- fuse = 2.5" wide x 30" long -- ends = 3.75" wide 0.043" (1.09mm) 33 ksi (230 MPa)	<input type="checkbox"/>	Reduced section strap -- fuse = 2.75" wide x 30" long -- ends = 4.25" wide 0.054" (1.37mm) 50 ksi (340 MPa)	<input type="checkbox"/>	Reduced section strap -- fuse = 4" wide x 30" long -- ends = 6" wide 0.068" (1.73mm) 50 ksi (340 MPa)	<input type="checkbox"/>	Reduced section strap -- fuse = 2.5" wide x 60" long -- ends = 3.75" wide 0.043" (1.09mm) 33 ksi (230 MPa)	<input type="checkbox"/>	Reduced section strap -- fuse = 4" wide x 60" long -- ends = 6" wide 0.068" (1.73mm) 50 ksi (340 MPa)																	
<input type="checkbox"/>	2.5" 0.043" (1.09mm) 33 ksi (230 MPa)																																						
<input type="checkbox"/>	2.75" 0.054" (1.37mm) 50 ksi (340 MPa)																																						
<input checked="" type="checkbox"/>	4" 0.068" (1.73mm) 50 ksi (340 MPa)																																						
<input type="checkbox"/>	5" 0.043" (1.09) 33 ksi (230 MPa)																																						
<input type="checkbox"/>	Reduced section strap -- fuse = 2.5" wide x 30" long -- ends = 3.75" wide 0.043" (1.09mm) 33 ksi (230 MPa)																																						
<input type="checkbox"/>	Reduced section strap -- fuse = 2.75" wide x 30" long -- ends = 4.25" wide 0.054" (1.37mm) 50 ksi (340 MPa)																																						
<input type="checkbox"/>	Reduced section strap -- fuse = 4" wide x 30" long -- ends = 6" wide 0.068" (1.73mm) 50 ksi (340 MPa)																																						
<input type="checkbox"/>	Reduced section strap -- fuse = 2.5" wide x 60" long -- ends = 3.75" wide 0.043" (1.09mm) 33 ksi (230 MPa)																																						
<input type="checkbox"/>	Reduced section strap -- fuse = 4" wide x 60" long -- ends = 6" wide 0.068" (1.73mm) 50 ksi (340 MPa)																																						
INTERIOR STUDS:	<table border="1" style="width:100%; border-collapse: collapse;"> <tr><td><input type="checkbox"/></td><td>3-5/8"Wx1-5/8"Fx1/2"Lip 0.043" (1.09mm) 33ksi (230 Mpa)</td></tr> <tr><td><input checked="" type="checkbox"/></td><td>6"Wx1-5/8"Fx1/2"Lip 0.043" (1.09mm) 33ksi (230 Mpa)</td></tr> </table>		<input type="checkbox"/>	3-5/8"Wx1-5/8"Fx1/2"Lip 0.043" (1.09mm) 33ksi (230 Mpa)	<input checked="" type="checkbox"/>	6"Wx1-5/8"Fx1/2"Lip 0.043" (1.09mm) 33ksi (230 Mpa)	STUD SPACING:	<table border="1" style="width:100%; border-collapse: collapse;"> <tr><td><input checked="" type="checkbox"/></td><td>16" O.C.</td></tr> <tr><td><input type="checkbox"/></td><td>Other :</td></tr> </table>		<input checked="" type="checkbox"/>	16" O.C.	<input type="checkbox"/>	Other :																										
<input type="checkbox"/>	3-5/8"Wx1-5/8"Fx1/2"Lip 0.043" (1.09mm) 33ksi (230 Mpa)																																						
<input checked="" type="checkbox"/>	6"Wx1-5/8"Fx1/2"Lip 0.043" (1.09mm) 33ksi (230 Mpa)																																						
<input checked="" type="checkbox"/>	16" O.C.																																						
<input type="checkbox"/>	Other :																																						
BACK-TO-BACK CHORD STUDS:	<table border="1" style="width:100%; border-collapse: collapse;"> <tr><td><input type="checkbox"/></td><td>3-5/8"Wx1-5/8"Fx1/2"Lip 0.043" (1.09mm) 33ksi (230 Mpa)</td></tr> <tr><td><input type="checkbox"/></td><td>6"Wx1-5/8"Fx1/2"Lip 0.054" (1.37mm) 50ksi (345 Mpa)</td></tr> <tr><td><input checked="" type="checkbox"/></td><td>6"Wx1-5/8"Fx1/2"Lip 0.068" (1.73mm) 50ksi (345 Mpa)</td></tr> </table>				<input type="checkbox"/>	3-5/8"Wx1-5/8"Fx1/2"Lip 0.043" (1.09mm) 33ksi (230 Mpa)	<input type="checkbox"/>	6"Wx1-5/8"Fx1/2"Lip 0.054" (1.37mm) 50ksi (345 Mpa)	<input checked="" type="checkbox"/>	6"Wx1-5/8"Fx1/2"Lip 0.068" (1.73mm) 50ksi (345 Mpa)																													
<input type="checkbox"/>	3-5/8"Wx1-5/8"Fx1/2"Lip 0.043" (1.09mm) 33ksi (230 Mpa)																																						
<input type="checkbox"/>	6"Wx1-5/8"Fx1/2"Lip 0.054" (1.37mm) 50ksi (345 Mpa)																																						
<input checked="" type="checkbox"/>	6"Wx1-5/8"Fx1/2"Lip 0.068" (1.73mm) 50ksi (345 Mpa)																																						
CONNECTIONS:	<table border="1" style="width:100%; border-collapse: collapse;"> <tr><td><input checked="" type="checkbox"/></td><td>No.10 gauge 0.75" self-drilling wafer head (mod. Truss) Phillips drive</td></tr> <tr><td><input checked="" type="checkbox"/></td><td>Framing: No.8 gauge 0.5" self-drilling wafer head (mod. Truss) Phillips drive</td></tr> <tr><td><input checked="" type="checkbox"/></td><td>Hold downs: No.14 gauge1" self-drilling Hex washer head</td></tr> <tr><td><input type="checkbox"/></td><td>Back-to-Back</td></tr> <tr><td><input checked="" type="checkbox"/></td><td>Chord Studs: No.10 gauge 0.75" self-drilling Hex washer head</td></tr> <tr><td><input type="checkbox"/></td><td>Anchor Rods: 7/8" A193 Rod</td></tr> <tr><td><input type="checkbox"/></td><td><input type="checkbox"/></td><td>1" A193 Rod</td></tr> <tr><td><input checked="" type="checkbox"/></td><td>Loading Beam: A325 3/4" bolts</td></tr> <tr><td><input checked="" type="checkbox"/></td><td>Base: A325 3/4" bolts</td></tr> </table>				<input checked="" type="checkbox"/>	No.10 gauge 0.75" self-drilling wafer head (mod. Truss) Phillips drive	<input checked="" type="checkbox"/>	Framing: No.8 gauge 0.5" self-drilling wafer head (mod. Truss) Phillips drive	<input checked="" type="checkbox"/>	Hold downs: No.14 gauge1" self-drilling Hex washer head	<input type="checkbox"/>	Back-to-Back	<input checked="" type="checkbox"/>	Chord Studs: No.10 gauge 0.75" self-drilling Hex washer head	<input type="checkbox"/>	Anchor Rods: 7/8" A193 Rod	<input type="checkbox"/>	<input type="checkbox"/>	1" A193 Rod	<input checked="" type="checkbox"/>	Loading Beam: A325 3/4" bolts	<input checked="" type="checkbox"/>	Base: A325 3/4" bolts																
<input checked="" type="checkbox"/>	No.10 gauge 0.75" self-drilling wafer head (mod. Truss) Phillips drive																																						
<input checked="" type="checkbox"/>	Framing: No.8 gauge 0.5" self-drilling wafer head (mod. Truss) Phillips drive																																						
<input checked="" type="checkbox"/>	Hold downs: No.14 gauge1" self-drilling Hex washer head																																						
<input type="checkbox"/>	Back-to-Back																																						
<input checked="" type="checkbox"/>	Chord Studs: No.10 gauge 0.75" self-drilling Hex washer head																																						
<input type="checkbox"/>	Anchor Rods: 7/8" A193 Rod																																						
<input type="checkbox"/>	<input type="checkbox"/>	1" A193 Rod																																					
<input checked="" type="checkbox"/>	Loading Beam: A325 3/4" bolts																																						
<input checked="" type="checkbox"/>	Base: A325 3/4" bolts																																						
TRACK:	<table border="1" style="width:100%; border-collapse: collapse;"> <tr><td><input type="checkbox"/></td><td>Regular</td><td><input checked="" type="checkbox"/></td><td>6" web</td><td><input type="checkbox"/></td><td>0.043" (1.09mm) 33ksi (230 Mpa)</td></tr> <tr><td><input checked="" type="checkbox"/></td><td>Extended</td><td><input type="checkbox"/></td><td>3 5/8" web</td><td><input type="checkbox"/></td><td>0.054" (1.37mm) 50ksi (345 Mpa)</td></tr> <tr><td><input type="checkbox"/></td><td>Reinforced</td><td><input type="checkbox"/></td><td>1-1/4" flange</td><td><input type="checkbox"/></td><td>0.068" (1.73mm) 50ksi (345 Mpa)</td></tr> <tr><td><input type="checkbox"/></td><td></td><td><input type="checkbox"/></td><td></td><td><input checked="" type="checkbox"/></td><td>0.097" (1.73mm) 50ksi (345 Mpa)</td></tr> </table>				<input type="checkbox"/>	Regular	<input checked="" type="checkbox"/>	6" web	<input type="checkbox"/>	0.043" (1.09mm) 33ksi (230 Mpa)	<input checked="" type="checkbox"/>	Extended	<input type="checkbox"/>	3 5/8" web	<input type="checkbox"/>	0.054" (1.37mm) 50ksi (345 Mpa)	<input type="checkbox"/>	Reinforced	<input type="checkbox"/>	1-1/4" flange	<input type="checkbox"/>	0.068" (1.73mm) 50ksi (345 Mpa)	<input type="checkbox"/>		<input type="checkbox"/>		<input checked="" type="checkbox"/>	0.097" (1.73mm) 50ksi (345 Mpa)											
<input type="checkbox"/>	Regular	<input checked="" type="checkbox"/>	6" web	<input type="checkbox"/>	0.043" (1.09mm) 33ksi (230 Mpa)																																		
<input checked="" type="checkbox"/>	Extended	<input type="checkbox"/>	3 5/8" web	<input type="checkbox"/>	0.054" (1.37mm) 50ksi (345 Mpa)																																		
<input type="checkbox"/>	Reinforced	<input type="checkbox"/>	1-1/4" flange	<input type="checkbox"/>	0.068" (1.73mm) 50ksi (345 Mpa)																																		
<input type="checkbox"/>		<input type="checkbox"/>		<input checked="" type="checkbox"/>	0.097" (1.73mm) 50ksi (345 Mpa)																																		
HOLD DOWNS:	<table border="1" style="width:100%; border-collapse: collapse;"> <tr><td><input type="checkbox"/></td><td>S/HD10S Simpson</td><td>inside</td><td>outside</td><td>raised</td></tr> <tr><td><input type="checkbox"/></td><td>Fabricated U-shape</td><td></td><td></td><td></td></tr> <tr><td><input type="checkbox"/></td><td>6" x 6" 0.054" (1.37mm) 50 ksi (340 MPa) Gusset Plate w/ S/HD15S Simpson</td><td></td><td></td><td></td></tr> <tr><td><input type="checkbox"/></td><td>7" x 9" 0.054" (1.37mm) 50 ksi (340 MPa) Gusset Plate w/ S/HD15S Simpson</td><td></td><td></td><td></td></tr> <tr><td><input checked="" type="checkbox"/></td><td>8" x 8" 0.068" (1.73mm) 50 ksi (340 MPa) Gusset Plate w/ S/HD15S Simpson</td><td><input checked="" type="checkbox"/></td><td></td><td></td></tr> <tr><td><input type="checkbox"/></td><td>8.5" x10" 0.068" (1.73mm) 50 ksi (340 MPa) Gusset Plate w/ S/HD15S Simpson</td><td></td><td></td><td></td></tr> <tr><td><input type="checkbox"/></td><td>10" x10" 0.054" (1.37mm) 50 ksi (340 MPa) Gusset Plate w/ S/HD15S Simpson</td><td></td><td></td><td></td></tr> </table>				<input type="checkbox"/>	S/HD10S Simpson	inside	outside	raised	<input type="checkbox"/>	Fabricated U-shape				<input type="checkbox"/>	6" x 6" 0.054" (1.37mm) 50 ksi (340 MPa) Gusset Plate w/ S/HD15S Simpson				<input type="checkbox"/>	7" x 9" 0.054" (1.37mm) 50 ksi (340 MPa) Gusset Plate w/ S/HD15S Simpson				<input checked="" type="checkbox"/>	8" x 8" 0.068" (1.73mm) 50 ksi (340 MPa) Gusset Plate w/ S/HD15S Simpson	<input checked="" type="checkbox"/>			<input type="checkbox"/>	8.5" x10" 0.068" (1.73mm) 50 ksi (340 MPa) Gusset Plate w/ S/HD15S Simpson				<input type="checkbox"/>	10" x10" 0.054" (1.37mm) 50 ksi (340 MPa) Gusset Plate w/ S/HD15S Simpson			
<input type="checkbox"/>	S/HD10S Simpson	inside	outside	raised																																			
<input type="checkbox"/>	Fabricated U-shape																																						
<input type="checkbox"/>	6" x 6" 0.054" (1.37mm) 50 ksi (340 MPa) Gusset Plate w/ S/HD15S Simpson																																						
<input type="checkbox"/>	7" x 9" 0.054" (1.37mm) 50 ksi (340 MPa) Gusset Plate w/ S/HD15S Simpson																																						
<input checked="" type="checkbox"/>	8" x 8" 0.068" (1.73mm) 50 ksi (340 MPa) Gusset Plate w/ S/HD15S Simpson	<input checked="" type="checkbox"/>																																					
<input type="checkbox"/>	8.5" x10" 0.068" (1.73mm) 50 ksi (340 MPa) Gusset Plate w/ S/HD15S Simpson																																						
<input type="checkbox"/>	10" x10" 0.054" (1.37mm) 50 ksi (340 MPa) Gusset Plate w/ S/HD15S Simpson																																						
TEST PROTOCOL AND DESCRIPTION:	<table border="1" style="width:100%; border-collapse: collapse;"> <tr><td><input type="checkbox"/></td><td>Monotonic (Rate of Loading 2.5 mm/min)</td></tr> <tr><td><input checked="" type="checkbox"/></td><td>Cyclic (CUREE cyclic protocol)</td></tr> </table>				<input type="checkbox"/>	Monotonic (Rate of Loading 2.5 mm/min)	<input checked="" type="checkbox"/>	Cyclic (CUREE cyclic protocol)																															
<input type="checkbox"/>	Monotonic (Rate of Loading 2.5 mm/min)																																						
<input checked="" type="checkbox"/>	Cyclic (CUREE cyclic protocol)																																						
LVDT MEASUREMENTS:	<table border="1" style="width:100%; border-collapse: collapse;"> <tr><td><input checked="" type="checkbox"/></td><td>Actuator LVDT</td><td><input checked="" type="checkbox"/></td><td>North Uplift</td></tr> <tr><td><input checked="" type="checkbox"/></td><td>North Slip</td><td><input checked="" type="checkbox"/></td><td>South Uplift</td></tr> <tr><td><input checked="" type="checkbox"/></td><td>South Slip</td><td><input checked="" type="checkbox"/></td><td>Top of Wall</td></tr> </table>				<input checked="" type="checkbox"/>	Actuator LVDT	<input checked="" type="checkbox"/>	North Uplift	<input checked="" type="checkbox"/>	North Slip	<input checked="" type="checkbox"/>	South Uplift	<input checked="" type="checkbox"/>	South Slip	<input checked="" type="checkbox"/>	Top of Wall																							
<input checked="" type="checkbox"/>	Actuator LVDT	<input checked="" type="checkbox"/>	North Uplift																																				
<input checked="" type="checkbox"/>	North Slip	<input checked="" type="checkbox"/>	South Uplift																																				
<input checked="" type="checkbox"/>	South Slip	<input checked="" type="checkbox"/>	Top of Wall																																				
				TOTAL: <input type="text" value="6"/>																																			
STRAP WIDTH BEFORE TEST:	<table border="1" style="width:100%; border-collapse: collapse;"> <tr><td>Front Right</td><td>Front Left, mm</td><td>Back Right, mm</td><td>Back Left, mm</td></tr> <tr><td>101.62</td><td>101.67</td><td>102.54</td><td>102.59</td></tr> <tr><td>101.38</td><td>101.27</td><td>102.35</td><td>102.27</td></tr> <tr><td>101.77</td><td>101.05</td><td>102.33</td><td>102.30</td></tr> <tr><td>AVG</td><td>101.59 mm</td><td>AVG</td><td>101.33 mm</td></tr> <tr><td></td><td></td><td>AVG</td><td>102.41 mm</td></tr> <tr><td></td><td></td><td></td><td>AVG</td><td>102.39 mm</td></tr> </table>				Front Right	Front Left, mm	Back Right, mm	Back Left, mm	101.62	101.67	102.54	102.59	101.38	101.27	102.35	102.27	101.77	101.05	102.33	102.30	AVG	101.59 mm	AVG	101.33 mm			AVG	102.41 mm				AVG	102.39 mm						
Front Right	Front Left, mm	Back Right, mm	Back Left, mm																																				
101.62	101.67	102.54	102.59																																				
101.38	101.27	102.35	102.27																																				
101.77	101.05	102.33	102.30																																				
AVG	101.59 mm	AVG	101.33 mm																																				
		AVG	102.41 mm																																				
			AVG	102.39 mm																																			
DATA ACQ. RECORD RATE:	100 scan/sec		MONITOR RATE:	100 scan/sec																																			
COMMENTS:	<ul style="list-style-type: none"> -Shear anchors torqued for 10 s with impact wrench -Hold down anchors 1/2 turn from finger tight (load cells used on both hold-downs) -Double chord studs used screwed back to back -Square plate washers (2.5"x2.5") used in all top track connections -Regular washers used in all bottom track connections 																																						

Figure E.35: Data sheet for test 22A-C

Cold Formed Steel Strap Braced Walls McGill University, Montreal																													
TEST:		24A-C																											
RESEARCHER:	Gilles Comeau		ASSISTANTS:	Kostadin Velchev, Nisreen Bah																									
DATE:	25-Jul-07		TIME:	8:30AM																									
DIMENSIONS OF WALL:	8 FT X	8 FT X	6 IN.	INITIAL STRAP SURVEY:	Front Right Back Tight Left Tight Tight																								
STRAP FASTENER CONFIGURATION: MFR: McGill																													
STRAP SIZE:	<table border="1" style="width:100%; border-collapse: collapse;"> <tr><td><input type="checkbox"/></td><td>2.5" 0.043" (1.09mm) 33 ksi (230 MPa)</td></tr> <tr><td><input type="checkbox"/></td><td>2.75" 0.054" (1.37mm) 50 ksi (340 MPa)</td></tr> <tr><td><input checked="" type="checkbox"/></td><td>4" 0.068" (1.73mm) 50 ksi (340 MPa)</td></tr> <tr><td><input type="checkbox"/></td><td>5" 0.043" (1.09) 33 ksi (230 MPa)</td></tr> <tr><td><input type="checkbox"/></td><td>Reduced section strap -- fuse = 2.5" wide x 30" long -- ends = 3.75" wide 0.043" (1.09mm) 33 ksi (230 MPa)</td></tr> <tr><td><input type="checkbox"/></td><td>Reduced section strap -- fuse = 2.75" wide x 30" long -- ends = 4.25" wide 0.054" (1.37mm) 50 ksi (340 MPa)</td></tr> <tr><td><input type="checkbox"/></td><td>Reduced section strap -- fuse = 4" wide x 30" long -- ends = 6" wide 0.068" (1.73mm) 50 ksi (340 MPa)</td></tr> <tr><td><input type="checkbox"/></td><td>Reduced section strap -- fuse = 2.5" wide x 60" long -- ends = 3.75" wide 0.043" (1.09mm) 33 ksi (230 MPa)</td></tr> <tr><td><input type="checkbox"/></td><td>Reduced section strap -- fuse = 4" wide x 60" long -- ends = 6" wide 0.068" (1.73mm) 50 ksi (340 MPa)</td></tr> </table>				<input type="checkbox"/>	2.5" 0.043" (1.09mm) 33 ksi (230 MPa)	<input type="checkbox"/>	2.75" 0.054" (1.37mm) 50 ksi (340 MPa)	<input checked="" type="checkbox"/>	4" 0.068" (1.73mm) 50 ksi (340 MPa)	<input type="checkbox"/>	5" 0.043" (1.09) 33 ksi (230 MPa)	<input type="checkbox"/>	Reduced section strap -- fuse = 2.5" wide x 30" long -- ends = 3.75" wide 0.043" (1.09mm) 33 ksi (230 MPa)	<input type="checkbox"/>	Reduced section strap -- fuse = 2.75" wide x 30" long -- ends = 4.25" wide 0.054" (1.37mm) 50 ksi (340 MPa)	<input type="checkbox"/>	Reduced section strap -- fuse = 4" wide x 30" long -- ends = 6" wide 0.068" (1.73mm) 50 ksi (340 MPa)	<input type="checkbox"/>	Reduced section strap -- fuse = 2.5" wide x 60" long -- ends = 3.75" wide 0.043" (1.09mm) 33 ksi (230 MPa)	<input type="checkbox"/>	Reduced section strap -- fuse = 4" wide x 60" long -- ends = 6" wide 0.068" (1.73mm) 50 ksi (340 MPa)							
<input type="checkbox"/>	2.5" 0.043" (1.09mm) 33 ksi (230 MPa)																												
<input type="checkbox"/>	2.75" 0.054" (1.37mm) 50 ksi (340 MPa)																												
<input checked="" type="checkbox"/>	4" 0.068" (1.73mm) 50 ksi (340 MPa)																												
<input type="checkbox"/>	5" 0.043" (1.09) 33 ksi (230 MPa)																												
<input type="checkbox"/>	Reduced section strap -- fuse = 2.5" wide x 30" long -- ends = 3.75" wide 0.043" (1.09mm) 33 ksi (230 MPa)																												
<input type="checkbox"/>	Reduced section strap -- fuse = 2.75" wide x 30" long -- ends = 4.25" wide 0.054" (1.37mm) 50 ksi (340 MPa)																												
<input type="checkbox"/>	Reduced section strap -- fuse = 4" wide x 30" long -- ends = 6" wide 0.068" (1.73mm) 50 ksi (340 MPa)																												
<input type="checkbox"/>	Reduced section strap -- fuse = 2.5" wide x 60" long -- ends = 3.75" wide 0.043" (1.09mm) 33 ksi (230 MPa)																												
<input type="checkbox"/>	Reduced section strap -- fuse = 4" wide x 60" long -- ends = 6" wide 0.068" (1.73mm) 50 ksi (340 MPa)																												
INTERIOR STUDS:	<table border="1" style="width:100%; border-collapse: collapse;"> <tr><td><input type="checkbox"/></td><td>3-5/8"Wx1-5/8"Fx1/2"Lip 0.043" (1.09mm) 33ksi (230 Mpa)</td></tr> <tr><td><input checked="" type="checkbox"/></td><td>6"Wx1-5/8"Fx1/2"Lip 0.043" (1.09mm) 33ksi (230 Mpa)</td></tr> </table>		<input type="checkbox"/>	3-5/8"Wx1-5/8"Fx1/2"Lip 0.043" (1.09mm) 33ksi (230 Mpa)	<input checked="" type="checkbox"/>	6"Wx1-5/8"Fx1/2"Lip 0.043" (1.09mm) 33ksi (230 Mpa)	STUD SPACING:	<table border="1" style="width:100%; border-collapse: collapse;"> <tr><td><input checked="" type="checkbox"/></td><td>16" O.C.</td></tr> <tr><td><input type="checkbox"/></td><td>Other :</td></tr> </table>		<input checked="" type="checkbox"/>	16" O.C.	<input type="checkbox"/>	Other :																
<input type="checkbox"/>	3-5/8"Wx1-5/8"Fx1/2"Lip 0.043" (1.09mm) 33ksi (230 Mpa)																												
<input checked="" type="checkbox"/>	6"Wx1-5/8"Fx1/2"Lip 0.043" (1.09mm) 33ksi (230 Mpa)																												
<input checked="" type="checkbox"/>	16" O.C.																												
<input type="checkbox"/>	Other :																												
BACK-TO-BACK CHORD STUDS:	<table border="1" style="width:100%; border-collapse: collapse;"> <tr><td><input type="checkbox"/></td><td>3-5/8"Wx1-5/8"Fx1/2"Lip 0.043" (1.09mm) 33ksi (230 Mpa)</td></tr> <tr><td><input type="checkbox"/></td><td>6"Wx1-5/8"Fx1/2"Lip 0.054" (1.37mm) 50ksi (345 Mpa)</td></tr> <tr><td><input checked="" type="checkbox"/></td><td>6"Wx1-5/8"Fx1/2"Lip 0.068" (1.73mm) 50ksi (345 Mpa)</td></tr> </table>				<input type="checkbox"/>	3-5/8"Wx1-5/8"Fx1/2"Lip 0.043" (1.09mm) 33ksi (230 Mpa)	<input type="checkbox"/>	6"Wx1-5/8"Fx1/2"Lip 0.054" (1.37mm) 50ksi (345 Mpa)	<input checked="" type="checkbox"/>	6"Wx1-5/8"Fx1/2"Lip 0.068" (1.73mm) 50ksi (345 Mpa)																			
<input type="checkbox"/>	3-5/8"Wx1-5/8"Fx1/2"Lip 0.043" (1.09mm) 33ksi (230 Mpa)																												
<input type="checkbox"/>	6"Wx1-5/8"Fx1/2"Lip 0.054" (1.37mm) 50ksi (345 Mpa)																												
<input checked="" type="checkbox"/>	6"Wx1-5/8"Fx1/2"Lip 0.068" (1.73mm) 50ksi (345 Mpa)																												
CONNECTIONS:	<table border="1" style="width:100%; border-collapse: collapse;"> <tr><td><input checked="" type="checkbox"/></td><td>No.10 gauge 0.75" self-drilling wafer head (mod. Truss) Phillips drive</td></tr> <tr><td><input checked="" type="checkbox"/></td><td>No.8 gauge 0.5" self-drilling wafer head (mod. Truss) Phillips drive</td></tr> <tr><td><input checked="" type="checkbox"/></td><td>No.14 gauge 1" self-drilling Hex washer head</td></tr> <tr><td><input checked="" type="checkbox"/></td><td>No.10 gauge 0.75" self-drilling Hex washer head</td></tr> <tr><td><input type="checkbox"/></td><td>7/8" A193 Rod</td></tr> <tr><td><input checked="" type="checkbox"/></td><td>1" A193 Rod</td></tr> <tr><td><input checked="" type="checkbox"/></td><td>A325 3/4" bolts</td></tr> <tr><td><input checked="" type="checkbox"/></td><td>A325 3/4" bolts</td></tr> </table>				<input checked="" type="checkbox"/>	No.10 gauge 0.75" self-drilling wafer head (mod. Truss) Phillips drive	<input checked="" type="checkbox"/>	No.8 gauge 0.5" self-drilling wafer head (mod. Truss) Phillips drive	<input checked="" type="checkbox"/>	No.14 gauge 1" self-drilling Hex washer head	<input checked="" type="checkbox"/>	No.10 gauge 0.75" self-drilling Hex washer head	<input type="checkbox"/>	7/8" A193 Rod	<input checked="" type="checkbox"/>	1" A193 Rod	<input checked="" type="checkbox"/>	A325 3/4" bolts	<input checked="" type="checkbox"/>	A325 3/4" bolts									
<input checked="" type="checkbox"/>	No.10 gauge 0.75" self-drilling wafer head (mod. Truss) Phillips drive																												
<input checked="" type="checkbox"/>	No.8 gauge 0.5" self-drilling wafer head (mod. Truss) Phillips drive																												
<input checked="" type="checkbox"/>	No.14 gauge 1" self-drilling Hex washer head																												
<input checked="" type="checkbox"/>	No.10 gauge 0.75" self-drilling Hex washer head																												
<input type="checkbox"/>	7/8" A193 Rod																												
<input checked="" type="checkbox"/>	1" A193 Rod																												
<input checked="" type="checkbox"/>	A325 3/4" bolts																												
<input checked="" type="checkbox"/>	A325 3/4" bolts																												
TRACK:	<table border="1" style="width:100%; border-collapse: collapse;"> <tr><td><input checked="" type="checkbox"/></td><td>Regular</td></tr> <tr><td><input type="checkbox"/></td><td>Extended</td></tr> <tr><td><input type="checkbox"/></td><td>Reinforced</td></tr> </table>		<input checked="" type="checkbox"/>	Regular	<input type="checkbox"/>	Extended	<input type="checkbox"/>	Reinforced	<table border="1" style="width:100%; border-collapse: collapse;"> <tr><td><input checked="" type="checkbox"/></td><td>6" web</td></tr> <tr><td><input type="checkbox"/></td><td>3 5/8" web</td></tr> <tr><td><input type="checkbox"/></td><td>1-1/4" flange</td></tr> </table>			<input checked="" type="checkbox"/>	6" web	<input type="checkbox"/>	3 5/8" web	<input type="checkbox"/>	1-1/4" flange												
<input checked="" type="checkbox"/>	Regular																												
<input type="checkbox"/>	Extended																												
<input type="checkbox"/>	Reinforced																												
<input checked="" type="checkbox"/>	6" web																												
<input type="checkbox"/>	3 5/8" web																												
<input type="checkbox"/>	1-1/4" flange																												
HOLD DOWNS:	<table border="1" style="width:100%; border-collapse: collapse;"> <tr><td><input type="checkbox"/></td><td>S/HD10S Simpson</td></tr> <tr><td><input type="checkbox"/></td><td>Fabricated U-shape</td></tr> <tr><td><input type="checkbox"/></td><td>6" x 6" 0.054" (1.37mm) 50 ksi (340 MPa) Gusset Plate w/ S/HD15S Simpson</td></tr> <tr><td><input type="checkbox"/></td><td>7" x 9" 0.054" (1.37mm) 50 ksi (340 MPa) Gusset Plate w/ S/HD15S Simpson</td></tr> <tr><td><input checked="" type="checkbox"/></td><td>8" x 8" 0.068" (1.73mm) 50 ksi (340 MPa) Gusset Plate w/ S/HD15S Simpson</td></tr> <tr><td><input type="checkbox"/></td><td>8.5" x10" 0.068" (1.73mm) 50 ksi (340 MPa) Gusset Plate w/ S/HD15S Simpson</td></tr> <tr><td><input type="checkbox"/></td><td>10" x10" 0.054" (1.37mm) 50 ksi (340 MPa) Gusset Plate w/ S/HD15S Simpson</td></tr> </table>				<input type="checkbox"/>	S/HD10S Simpson	<input type="checkbox"/>	Fabricated U-shape	<input type="checkbox"/>	6" x 6" 0.054" (1.37mm) 50 ksi (340 MPa) Gusset Plate w/ S/HD15S Simpson	<input type="checkbox"/>	7" x 9" 0.054" (1.37mm) 50 ksi (340 MPa) Gusset Plate w/ S/HD15S Simpson	<input checked="" type="checkbox"/>	8" x 8" 0.068" (1.73mm) 50 ksi (340 MPa) Gusset Plate w/ S/HD15S Simpson	<input type="checkbox"/>	8.5" x10" 0.068" (1.73mm) 50 ksi (340 MPa) Gusset Plate w/ S/HD15S Simpson	<input type="checkbox"/>	10" x10" 0.054" (1.37mm) 50 ksi (340 MPa) Gusset Plate w/ S/HD15S Simpson											
<input type="checkbox"/>	S/HD10S Simpson																												
<input type="checkbox"/>	Fabricated U-shape																												
<input type="checkbox"/>	6" x 6" 0.054" (1.37mm) 50 ksi (340 MPa) Gusset Plate w/ S/HD15S Simpson																												
<input type="checkbox"/>	7" x 9" 0.054" (1.37mm) 50 ksi (340 MPa) Gusset Plate w/ S/HD15S Simpson																												
<input checked="" type="checkbox"/>	8" x 8" 0.068" (1.73mm) 50 ksi (340 MPa) Gusset Plate w/ S/HD15S Simpson																												
<input type="checkbox"/>	8.5" x10" 0.068" (1.73mm) 50 ksi (340 MPa) Gusset Plate w/ S/HD15S Simpson																												
<input type="checkbox"/>	10" x10" 0.054" (1.37mm) 50 ksi (340 MPa) Gusset Plate w/ S/HD15S Simpson																												
TEST PROTOCOL AND DESCRIPTION:	<table border="1" style="width:100%; border-collapse: collapse;"> <tr><td><input type="checkbox"/></td><td>Monotonic (Rate of Loading 2.5 mm/min)</td></tr> <tr><td><input checked="" type="checkbox"/></td><td>Cyclic (CUREE cyclic protocol)</td></tr> </table>				<input type="checkbox"/>	Monotonic (Rate of Loading 2.5 mm/min)	<input checked="" type="checkbox"/>	Cyclic (CUREE cyclic protocol)																					
<input type="checkbox"/>	Monotonic (Rate of Loading 2.5 mm/min)																												
<input checked="" type="checkbox"/>	Cyclic (CUREE cyclic protocol)																												
LVDT MEASUREMENTS:	<table border="1" style="width:100%; border-collapse: collapse;"> <tr><td><input checked="" type="checkbox"/></td><td>Actuator LVDT</td></tr> <tr><td><input checked="" type="checkbox"/></td><td>North Slip</td></tr> <tr><td><input checked="" type="checkbox"/></td><td>South Slip</td></tr> </table>		<input checked="" type="checkbox"/>	Actuator LVDT	<input checked="" type="checkbox"/>	North Slip	<input checked="" type="checkbox"/>	South Slip	<table border="1" style="width:100%; border-collapse: collapse;"> <tr><td><input checked="" type="checkbox"/></td><td>North Uplift</td></tr> <tr><td><input checked="" type="checkbox"/></td><td>South Uplift</td></tr> <tr><td><input checked="" type="checkbox"/></td><td>Top of Wall</td></tr> </table>		<input checked="" type="checkbox"/>	North Uplift	<input checked="" type="checkbox"/>	South Uplift	<input checked="" type="checkbox"/>	Top of Wall													
<input checked="" type="checkbox"/>	Actuator LVDT																												
<input checked="" type="checkbox"/>	North Slip																												
<input checked="" type="checkbox"/>	South Slip																												
<input checked="" type="checkbox"/>	North Uplift																												
<input checked="" type="checkbox"/>	South Uplift																												
<input checked="" type="checkbox"/>	Top of Wall																												
				TOTAL:	6																								
STRAP WIDTH BEFORE TEST:	<table border="1" style="width:100%; border-collapse: collapse;"> <tr> <td style="width: 25%;">Front Right</td> <td style="width: 25%;">Front Left, mm</td> <td style="width: 25%;">Back Right, mm</td> <td style="width: 25%;">Back Left, mm</td> </tr> <tr> <td style="text-align: center;">101.81</td> <td style="text-align: center;">102.30</td> <td style="text-align: center;">101.00</td> <td style="text-align: center;">101.54</td> </tr> <tr> <td style="text-align: center;">101.27</td> <td style="text-align: center;">102.42</td> <td style="text-align: center;">101.19</td> <td style="text-align: center;">101.24</td> </tr> <tr> <td style="text-align: center;">100.96</td> <td style="text-align: center;">102.59</td> <td style="text-align: center;">101.99</td> <td style="text-align: center;">101.04</td> </tr> <tr> <td style="text-align: center;">AVG</td> <td style="text-align: center;">101.35 mm</td> <td style="text-align: center;">AVG</td> <td style="text-align: center;">102.44 mm</td> </tr> <tr> <td style="text-align: center;">AVG</td> <td style="text-align: center;">101.39 mm</td> <td style="text-align: center;">AVG</td> <td style="text-align: center;">101.27 mm</td> </tr> </table>					Front Right	Front Left, mm	Back Right, mm	Back Left, mm	101.81	102.30	101.00	101.54	101.27	102.42	101.19	101.24	100.96	102.59	101.99	101.04	AVG	101.35 mm	AVG	102.44 mm	AVG	101.39 mm	AVG	101.27 mm
Front Right	Front Left, mm	Back Right, mm	Back Left, mm																										
101.81	102.30	101.00	101.54																										
101.27	102.42	101.19	101.24																										
100.96	102.59	101.99	101.04																										
AVG	101.35 mm	AVG	102.44 mm																										
AVG	101.39 mm	AVG	101.27 mm																										
DATA ACQ. RECORD RATE:	100 scan/sec		MONITOR RATE:	100 scan/sec																									
COMMENTS:	<ul style="list-style-type: none"> -Shear anchors torqued for 10 s with impact wrench -Hold down anchors 1/2 turn from finger tight (load cells used on both hold-downs) -Double chord studs used screwed back to back -Square plate washers (2.5"x2.5") used in all top track connections -Regular washers used in all bottom track connections 																												

Figure E.37: Data sheet for test 24A-C

Cold Formed Steel Strap Braced Walls McGill University, Montreal																																									
TEST:		24B-C																																							
RESEARCHER:	Gilles Comeau		ASSISTANTS:	Kostadin Velchev, Nisreen Bah																																					
DATE:	19-Jul-07		TIME:	3:00PM																																					
DIMENSIONS OF WALL:	4 FT X	8 FT X	6 IN.	INITIAL STRAP SURVEY:	Front Right Back Tight Left Tight Tight																																				
STRAP FASTENER CONFIGURATION: MFR: McGill																																									
STRAP SIZE:	<table border="1" style="width:100%; border-collapse: collapse;"> <tr><td><input type="checkbox"/></td><td>2.5" 0.043" (1.09mm) 33 ksi (230 MPa)</td></tr> <tr><td><input type="checkbox"/></td><td>2.75" 0.054" (1.37mm) 50 ksi (340 MPa)</td></tr> <tr><td><input checked="" type="checkbox"/></td><td>4" 0.068" (1.73mm) 50 ksi (340 MPa)</td></tr> <tr><td><input type="checkbox"/></td><td>5" 0.043" (1.09) 33 ksi (230 MPa)</td></tr> <tr><td><input type="checkbox"/></td><td>Reduced section strap -- fuse = 2.5" wide x 30" long -- ends = 3.75" wide 0.043" (1.09mm) 33 ksi (230 MPa)</td></tr> <tr><td><input type="checkbox"/></td><td>Reduced section strap -- fuse = 2.75" wide x 30" long -- ends = 4.25" wide 0.054" (1.37mm) 50 ksi (340 MPa)</td></tr> <tr><td><input type="checkbox"/></td><td>Reduced section strap -- fuse = 4" wide x 30" long -- ends = 6" wide 0.068" (1.73mm) 50 ksi (340 MPa)</td></tr> <tr><td><input type="checkbox"/></td><td>Reduced section strap -- fuse = 2.5" wide x 60" long -- ends = 3.75" wide 0.043" (1.09mm) 33 ksi (230 MPa)</td></tr> <tr><td><input type="checkbox"/></td><td>Reduced section strap -- fuse = 4" wide x 60" long -- ends = 6" wide 0.068" (1.73mm) 50 ksi (340 MPa)</td></tr> </table>				<input type="checkbox"/>	2.5" 0.043" (1.09mm) 33 ksi (230 MPa)	<input type="checkbox"/>	2.75" 0.054" (1.37mm) 50 ksi (340 MPa)	<input checked="" type="checkbox"/>	4" 0.068" (1.73mm) 50 ksi (340 MPa)	<input type="checkbox"/>	5" 0.043" (1.09) 33 ksi (230 MPa)	<input type="checkbox"/>	Reduced section strap -- fuse = 2.5" wide x 30" long -- ends = 3.75" wide 0.043" (1.09mm) 33 ksi (230 MPa)	<input type="checkbox"/>	Reduced section strap -- fuse = 2.75" wide x 30" long -- ends = 4.25" wide 0.054" (1.37mm) 50 ksi (340 MPa)	<input type="checkbox"/>	Reduced section strap -- fuse = 4" wide x 30" long -- ends = 6" wide 0.068" (1.73mm) 50 ksi (340 MPa)	<input type="checkbox"/>	Reduced section strap -- fuse = 2.5" wide x 60" long -- ends = 3.75" wide 0.043" (1.09mm) 33 ksi (230 MPa)	<input type="checkbox"/>	Reduced section strap -- fuse = 4" wide x 60" long -- ends = 6" wide 0.068" (1.73mm) 50 ksi (340 MPa)																			
<input type="checkbox"/>	2.5" 0.043" (1.09mm) 33 ksi (230 MPa)																																								
<input type="checkbox"/>	2.75" 0.054" (1.37mm) 50 ksi (340 MPa)																																								
<input checked="" type="checkbox"/>	4" 0.068" (1.73mm) 50 ksi (340 MPa)																																								
<input type="checkbox"/>	5" 0.043" (1.09) 33 ksi (230 MPa)																																								
<input type="checkbox"/>	Reduced section strap -- fuse = 2.5" wide x 30" long -- ends = 3.75" wide 0.043" (1.09mm) 33 ksi (230 MPa)																																								
<input type="checkbox"/>	Reduced section strap -- fuse = 2.75" wide x 30" long -- ends = 4.25" wide 0.054" (1.37mm) 50 ksi (340 MPa)																																								
<input type="checkbox"/>	Reduced section strap -- fuse = 4" wide x 30" long -- ends = 6" wide 0.068" (1.73mm) 50 ksi (340 MPa)																																								
<input type="checkbox"/>	Reduced section strap -- fuse = 2.5" wide x 60" long -- ends = 3.75" wide 0.043" (1.09mm) 33 ksi (230 MPa)																																								
<input type="checkbox"/>	Reduced section strap -- fuse = 4" wide x 60" long -- ends = 6" wide 0.068" (1.73mm) 50 ksi (340 MPa)																																								
INTERIOR STUDS:	<table border="1" style="width:100%; border-collapse: collapse;"> <tr><td><input type="checkbox"/></td><td>3-5/8"Wx1-5/8"Fx1/2"Lip 0.043" (1.09mm) 33ksi (230 Mpa)</td></tr> <tr><td><input checked="" type="checkbox"/></td><td>6"Wx1-5/8"Fx1/2"Lip 0.043" (1.09mm) 33ksi (230 Mpa)</td></tr> </table>		<input type="checkbox"/>	3-5/8"Wx1-5/8"Fx1/2"Lip 0.043" (1.09mm) 33ksi (230 Mpa)	<input checked="" type="checkbox"/>	6"Wx1-5/8"Fx1/2"Lip 0.043" (1.09mm) 33ksi (230 Mpa)	STUD SPACING:	<table border="1" style="width:100%; border-collapse: collapse;"> <tr><td><input checked="" type="checkbox"/></td><td>16" O.C.</td></tr> <tr><td><input type="checkbox"/></td><td>Other :</td></tr> </table>		<input checked="" type="checkbox"/>	16" O.C.	<input type="checkbox"/>	Other :																												
<input type="checkbox"/>	3-5/8"Wx1-5/8"Fx1/2"Lip 0.043" (1.09mm) 33ksi (230 Mpa)																																								
<input checked="" type="checkbox"/>	6"Wx1-5/8"Fx1/2"Lip 0.043" (1.09mm) 33ksi (230 Mpa)																																								
<input checked="" type="checkbox"/>	16" O.C.																																								
<input type="checkbox"/>	Other :																																								
BACK-TO-BACK CHORD STUDS:	<table border="1" style="width:100%; border-collapse: collapse;"> <tr><td><input type="checkbox"/></td><td>3-5/8"Wx1-5/8"Fx1/2"Lip 0.043" (1.09mm) 33ksi (230 Mpa)</td></tr> <tr><td><input type="checkbox"/></td><td>6"Wx1-5/8"Fx1/2"Lip 0.054" (1.37mm) 50ksi (345 Mpa)</td></tr> <tr><td><input checked="" type="checkbox"/></td><td>6"Wx1-5/8"Fx1/2"Lip 0.068" (1.73mm) 50ksi (345 Mpa)</td></tr> </table>				<input type="checkbox"/>	3-5/8"Wx1-5/8"Fx1/2"Lip 0.043" (1.09mm) 33ksi (230 Mpa)	<input type="checkbox"/>	6"Wx1-5/8"Fx1/2"Lip 0.054" (1.37mm) 50ksi (345 Mpa)	<input checked="" type="checkbox"/>	6"Wx1-5/8"Fx1/2"Lip 0.068" (1.73mm) 50ksi (345 Mpa)																															
<input type="checkbox"/>	3-5/8"Wx1-5/8"Fx1/2"Lip 0.043" (1.09mm) 33ksi (230 Mpa)																																								
<input type="checkbox"/>	6"Wx1-5/8"Fx1/2"Lip 0.054" (1.37mm) 50ksi (345 Mpa)																																								
<input checked="" type="checkbox"/>	6"Wx1-5/8"Fx1/2"Lip 0.068" (1.73mm) 50ksi (345 Mpa)																																								
CONNECTIONS:	<table border="1" style="width:100%; border-collapse: collapse;"> <tr><td><input checked="" type="checkbox"/></td><td>No.10 gauge 0.75" self-drilling wafer head (mod. Truss) Phillips drive</td></tr> <tr><td><input checked="" type="checkbox"/></td><td>Framing: No.8 gauge 0.5" self-drilling wafer head (mod. Truss) Phillips drive</td></tr> <tr><td><input checked="" type="checkbox"/></td><td>Hold downs: No.14 gauge1" self-drilling Hex washer head</td></tr> <tr><td><input type="checkbox"/></td><td>Back-to-Back</td></tr> <tr><td><input checked="" type="checkbox"/></td><td>Chord Studs: No.10 gauge 0.75" self-drilling Hex washer head</td></tr> <tr><td><input type="checkbox"/></td><td>Anchor Rods: 7/8" A193 Rod</td></tr> <tr><td><input checked="" type="checkbox"/></td><td>1" A193 Rod</td></tr> <tr><td><input checked="" type="checkbox"/></td><td>Loading Beam: A325 3/4" bolts</td></tr> <tr><td><input checked="" type="checkbox"/></td><td>Base: A325 3/4" bolts</td></tr> </table>				<input checked="" type="checkbox"/>	No.10 gauge 0.75" self-drilling wafer head (mod. Truss) Phillips drive	<input checked="" type="checkbox"/>	Framing: No.8 gauge 0.5" self-drilling wafer head (mod. Truss) Phillips drive	<input checked="" type="checkbox"/>	Hold downs: No.14 gauge1" self-drilling Hex washer head	<input type="checkbox"/>	Back-to-Back	<input checked="" type="checkbox"/>	Chord Studs: No.10 gauge 0.75" self-drilling Hex washer head	<input type="checkbox"/>	Anchor Rods: 7/8" A193 Rod	<input checked="" type="checkbox"/>	1" A193 Rod	<input checked="" type="checkbox"/>	Loading Beam: A325 3/4" bolts	<input checked="" type="checkbox"/>	Base: A325 3/4" bolts																			
<input checked="" type="checkbox"/>	No.10 gauge 0.75" self-drilling wafer head (mod. Truss) Phillips drive																																								
<input checked="" type="checkbox"/>	Framing: No.8 gauge 0.5" self-drilling wafer head (mod. Truss) Phillips drive																																								
<input checked="" type="checkbox"/>	Hold downs: No.14 gauge1" self-drilling Hex washer head																																								
<input type="checkbox"/>	Back-to-Back																																								
<input checked="" type="checkbox"/>	Chord Studs: No.10 gauge 0.75" self-drilling Hex washer head																																								
<input type="checkbox"/>	Anchor Rods: 7/8" A193 Rod																																								
<input checked="" type="checkbox"/>	1" A193 Rod																																								
<input checked="" type="checkbox"/>	Loading Beam: A325 3/4" bolts																																								
<input checked="" type="checkbox"/>	Base: A325 3/4" bolts																																								
TRACK:	<table border="1" style="width:100%; border-collapse: collapse;"> <tr><td><input checked="" type="checkbox"/></td><td>Regular</td></tr> <tr><td><input type="checkbox"/></td><td>Extended</td></tr> <tr><td><input type="checkbox"/></td><td>Reinforced</td></tr> </table>		<input checked="" type="checkbox"/>	Regular	<input type="checkbox"/>	Extended	<input type="checkbox"/>	Reinforced	<table border="1" style="width:100%; border-collapse: collapse;"> <tr><td><input checked="" type="checkbox"/></td><td>6" web</td></tr> <tr><td><input type="checkbox"/></td><td>3 5/8" web</td></tr> <tr><td><input type="checkbox"/></td><td>1-1/4" flange</td></tr> </table>			<input checked="" type="checkbox"/>	6" web	<input type="checkbox"/>	3 5/8" web	<input type="checkbox"/>	1-1/4" flange																								
<input checked="" type="checkbox"/>	Regular																																								
<input type="checkbox"/>	Extended																																								
<input type="checkbox"/>	Reinforced																																								
<input checked="" type="checkbox"/>	6" web																																								
<input type="checkbox"/>	3 5/8" web																																								
<input type="checkbox"/>	1-1/4" flange																																								
HOLD DOWNS:	<table border="1" style="width:100%; border-collapse: collapse;"> <tr><td><input type="checkbox"/></td><td>S/HD10S Simpson</td></tr> <tr><td><input type="checkbox"/></td><td>Fabricated U-shape</td></tr> <tr><td><input type="checkbox"/></td><td>6" x 6" 0.054" (1.37mm) 50 ksi (340 MPa) Gusset Plate w/ S/HD15S Simpson</td></tr> <tr><td><input type="checkbox"/></td><td>7" x 9" 0.054" (1.37mm) 50 ksi (340 MPa) Gusset Plate w/ S/HD15S Simpson</td></tr> <tr><td><input checked="" type="checkbox"/></td><td>8" x 8" 0.068" (1.73mm) 50 ksi (340 MPa) Gusset Plate w/ S/HD15S Simpson</td></tr> <tr><td><input type="checkbox"/></td><td>8.5" x10" 0.068" (1.73mm) 50 ksi (340 MPa) Gusset Plate w/ S/HD15S Simpson</td></tr> <tr><td><input type="checkbox"/></td><td>10" x10" 0.054" (1.37mm) 50 ksi (340 MPa) Gusset Plate w/ S/HD15S Simpson</td></tr> </table>				<input type="checkbox"/>	S/HD10S Simpson	<input type="checkbox"/>	Fabricated U-shape	<input type="checkbox"/>	6" x 6" 0.054" (1.37mm) 50 ksi (340 MPa) Gusset Plate w/ S/HD15S Simpson	<input type="checkbox"/>	7" x 9" 0.054" (1.37mm) 50 ksi (340 MPa) Gusset Plate w/ S/HD15S Simpson	<input checked="" type="checkbox"/>	8" x 8" 0.068" (1.73mm) 50 ksi (340 MPa) Gusset Plate w/ S/HD15S Simpson	<input type="checkbox"/>	8.5" x10" 0.068" (1.73mm) 50 ksi (340 MPa) Gusset Plate w/ S/HD15S Simpson	<input type="checkbox"/>	10" x10" 0.054" (1.37mm) 50 ksi (340 MPa) Gusset Plate w/ S/HD15S Simpson																							
<input type="checkbox"/>	S/HD10S Simpson																																								
<input type="checkbox"/>	Fabricated U-shape																																								
<input type="checkbox"/>	6" x 6" 0.054" (1.37mm) 50 ksi (340 MPa) Gusset Plate w/ S/HD15S Simpson																																								
<input type="checkbox"/>	7" x 9" 0.054" (1.37mm) 50 ksi (340 MPa) Gusset Plate w/ S/HD15S Simpson																																								
<input checked="" type="checkbox"/>	8" x 8" 0.068" (1.73mm) 50 ksi (340 MPa) Gusset Plate w/ S/HD15S Simpson																																								
<input type="checkbox"/>	8.5" x10" 0.068" (1.73mm) 50 ksi (340 MPa) Gusset Plate w/ S/HD15S Simpson																																								
<input type="checkbox"/>	10" x10" 0.054" (1.37mm) 50 ksi (340 MPa) Gusset Plate w/ S/HD15S Simpson																																								
TEST PROTOCOL AND DESCRIPTION:	<table border="1" style="width:100%; border-collapse: collapse;"> <tr><td><input type="checkbox"/></td><td>Monotonic (Rate of Loading 2.5 mm/min)</td></tr> <tr><td><input checked="" type="checkbox"/></td><td>Cyclic (CUREE cyclic protocol)</td></tr> </table>				<input type="checkbox"/>	Monotonic (Rate of Loading 2.5 mm/min)	<input checked="" type="checkbox"/>	Cyclic (CUREE cyclic protocol)																																	
<input type="checkbox"/>	Monotonic (Rate of Loading 2.5 mm/min)																																								
<input checked="" type="checkbox"/>	Cyclic (CUREE cyclic protocol)																																								
LVDT MEASUREMENTS:	<table border="1" style="width:100%; border-collapse: collapse;"> <tr><td><input checked="" type="checkbox"/></td><td>Actuator LVDT</td></tr> <tr><td><input checked="" type="checkbox"/></td><td>North Slip</td></tr> <tr><td><input checked="" type="checkbox"/></td><td>South Slip</td></tr> </table>		<input checked="" type="checkbox"/>	Actuator LVDT	<input checked="" type="checkbox"/>	North Slip	<input checked="" type="checkbox"/>	South Slip	<table border="1" style="width:100%; border-collapse: collapse;"> <tr><td><input checked="" type="checkbox"/></td><td>North Uplift</td></tr> <tr><td><input checked="" type="checkbox"/></td><td>South Uplift</td></tr> <tr><td><input checked="" type="checkbox"/></td><td>Top of Wall</td></tr> </table>		<input checked="" type="checkbox"/>	North Uplift	<input checked="" type="checkbox"/>	South Uplift	<input checked="" type="checkbox"/>	Top of Wall																									
<input checked="" type="checkbox"/>	Actuator LVDT																																								
<input checked="" type="checkbox"/>	North Slip																																								
<input checked="" type="checkbox"/>	South Slip																																								
<input checked="" type="checkbox"/>	North Uplift																																								
<input checked="" type="checkbox"/>	South Uplift																																								
<input checked="" type="checkbox"/>	Top of Wall																																								
				TOTAL:	6																																				
STRAP WIDTH BEFORE TEST:	<table border="1" style="width:100%; border-collapse: collapse;"> <tr> <td></td> <td style="text-align: center;">Front Right</td> <td style="text-align: center;">Front Left, mm</td> <td style="text-align: center;">Back Right, mm</td> <td style="text-align: center;">Back Left, mm</td> <td></td> </tr> <tr> <td></td> <td style="text-align: center;">101</td> <td style="text-align: center;">102.53</td> <td style="text-align: center;">100.31</td> <td style="text-align: center;">102.43</td> <td></td> </tr> <tr> <td></td> <td style="text-align: center;">101.48</td> <td style="text-align: center;">102.37</td> <td style="text-align: center;">101.13</td> <td style="text-align: center;">102.31</td> <td></td> </tr> <tr> <td></td> <td style="text-align: center;">102.25</td> <td style="text-align: center;">102.31</td> <td style="text-align: center;">101.82</td> <td style="text-align: center;">102.33</td> <td></td> </tr> <tr> <td></td> <td style="text-align: center;">AVG</td> <td style="text-align: center;">101.58 mm</td> <td style="text-align: center;">AVG</td> <td style="text-align: center;">102.40 mm</td> <td style="text-align: center;">AVG</td> </tr> <tr> <td></td> <td></td> <td></td> <td style="text-align: center;">101.09 mm</td> <td style="text-align: center;">AVG</td> <td style="text-align: center;">102.36 mm</td> </tr> </table>						Front Right	Front Left, mm	Back Right, mm	Back Left, mm			101	102.53	100.31	102.43			101.48	102.37	101.13	102.31			102.25	102.31	101.82	102.33			AVG	101.58 mm	AVG	102.40 mm	AVG				101.09 mm	AVG	102.36 mm
	Front Right	Front Left, mm	Back Right, mm	Back Left, mm																																					
	101	102.53	100.31	102.43																																					
	101.48	102.37	101.13	102.31																																					
	102.25	102.31	101.82	102.33																																					
	AVG	101.58 mm	AVG	102.40 mm	AVG																																				
			101.09 mm	AVG	102.36 mm																																				
DATA ACQ. RECORD RATE:	100 scan/sec		MONITOR RATE:	100 scan/sec																																					
COMMENTS:	<ul style="list-style-type: none"> -Shear anchors torqued for 10 s with impact wrench -Hold down anchors 1/2 turn from finger tight (load cells used on both hold-downs) -Double chord studs used screwed back to back -Square plate washers (2.5"x2.5") used in all top track connections -Regular washers used in all bottom track connections 																																								

Figure E.39: Data sheet for test 24B-C



Light Gauge Steel Frame Strap Braced Shear Wall Testing

Test name : 24B-C
 Date tested : 14 July 2007
 Wall Size : 4' x 8'
 Strap Size : 4"
 Extended Track : yes no
 Holddown : inside outside
 Test mode : Cyclic Monotonic

Front side notes:

No load cells @
 holddowns.
 No screws through
 straps @ stud locations

Back side notes:

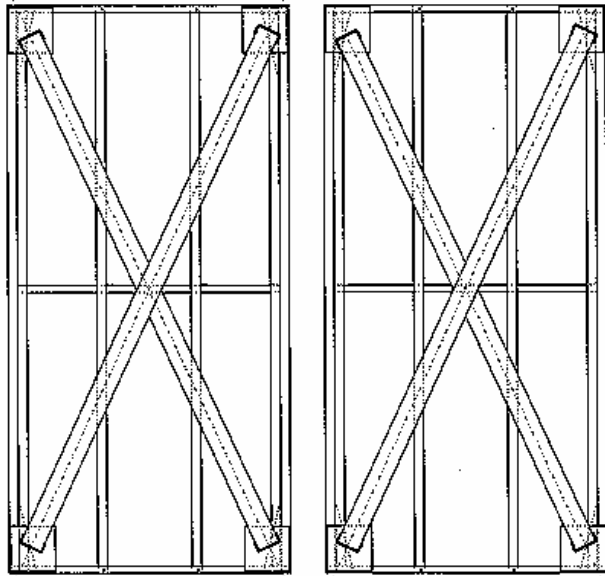

(N)

Front

(S) (S)

Back

(N)

Figure E.40: Observations for test 24B-C

Cold Formed Steel Strap Braced Walls McGill University, Montreal																																							
TEST:		24C-C																																					
RESEARCHER:	Gilles Comeau		ASSISTANTS:	Kostadin Velchev, Nisreen Bah																																			
DATE:	19-Jul-07		TIME:	10:30AM																																			
DIMENSIONS OF WALL:	2 FT X	8 FT X	6 IN.	INITIAL STRAP SURVEY:	<table style="font-size: small;"> <tr><td>Front</td><td>Right</td><td>Left</td></tr> <tr><td>Back</td><td>Tight</td><td>Tight</td></tr> <tr><td></td><td>Loose</td><td>Loose</td></tr> </table>	Front	Right	Left	Back	Tight	Tight		Loose	Loose																									
Front	Right	Left																																					
Back	Tight	Tight																																					
	Loose	Loose																																					
STRAP FASTENER CONFIGURATION: MFR: McGill																																							
STRAP SIZE:	<table style="font-size: small;"> <tr><td><input type="checkbox"/></td><td>2.5" 0.043" (1.09mm) 33 ksi (230 MPa)</td></tr> <tr><td><input type="checkbox"/></td><td>2.75" 0.054" (1.37mm) 50 ksi (340 MPa)</td></tr> <tr><td><input checked="" type="checkbox"/></td><td>4" 0.068" (1.73mm) 50 ksi (340 MPa)</td></tr> <tr><td><input type="checkbox"/></td><td>5" 0.043" (1.09) 33 ksi (230 MPa)</td></tr> <tr><td><input type="checkbox"/></td><td>Reduced section strap -- fuse = 2.5" wide x 30" long -- ends = 3.75" wide 0.043" (1.09mm) 33 ksi (230 MPa)</td></tr> <tr><td><input type="checkbox"/></td><td>Reduced section strap -- fuse = 2.75" wide x 30" long -- ends = 4.25" wide 0.054" (1.37mm) 50 ksi (340 MPa)</td></tr> <tr><td><input type="checkbox"/></td><td>Reduced section strap -- fuse = 4" wide x 30" long -- ends = 6" wide 0.068" (1.73mm) 50 ksi (340 MPa)</td></tr> <tr><td><input type="checkbox"/></td><td>Reduced section strap -- fuse = 2.5" wide x 60" long -- ends = 3.75" wide 0.043" (1.09mm) 33 ksi (230 MPa)</td></tr> <tr><td><input type="checkbox"/></td><td>Reduced section strap -- fuse = 4" wide x 60" long -- ends = 6" wide 0.068" (1.73mm) 50 ksi (340 MPa)</td></tr> </table>				<input type="checkbox"/>	2.5" 0.043" (1.09mm) 33 ksi (230 MPa)	<input type="checkbox"/>	2.75" 0.054" (1.37mm) 50 ksi (340 MPa)	<input checked="" type="checkbox"/>	4" 0.068" (1.73mm) 50 ksi (340 MPa)	<input type="checkbox"/>	5" 0.043" (1.09) 33 ksi (230 MPa)	<input type="checkbox"/>	Reduced section strap -- fuse = 2.5" wide x 30" long -- ends = 3.75" wide 0.043" (1.09mm) 33 ksi (230 MPa)	<input type="checkbox"/>	Reduced section strap -- fuse = 2.75" wide x 30" long -- ends = 4.25" wide 0.054" (1.37mm) 50 ksi (340 MPa)	<input type="checkbox"/>	Reduced section strap -- fuse = 4" wide x 30" long -- ends = 6" wide 0.068" (1.73mm) 50 ksi (340 MPa)	<input type="checkbox"/>	Reduced section strap -- fuse = 2.5" wide x 60" long -- ends = 3.75" wide 0.043" (1.09mm) 33 ksi (230 MPa)	<input type="checkbox"/>	Reduced section strap -- fuse = 4" wide x 60" long -- ends = 6" wide 0.068" (1.73mm) 50 ksi (340 MPa)																	
<input type="checkbox"/>	2.5" 0.043" (1.09mm) 33 ksi (230 MPa)																																						
<input type="checkbox"/>	2.75" 0.054" (1.37mm) 50 ksi (340 MPa)																																						
<input checked="" type="checkbox"/>	4" 0.068" (1.73mm) 50 ksi (340 MPa)																																						
<input type="checkbox"/>	5" 0.043" (1.09) 33 ksi (230 MPa)																																						
<input type="checkbox"/>	Reduced section strap -- fuse = 2.5" wide x 30" long -- ends = 3.75" wide 0.043" (1.09mm) 33 ksi (230 MPa)																																						
<input type="checkbox"/>	Reduced section strap -- fuse = 2.75" wide x 30" long -- ends = 4.25" wide 0.054" (1.37mm) 50 ksi (340 MPa)																																						
<input type="checkbox"/>	Reduced section strap -- fuse = 4" wide x 30" long -- ends = 6" wide 0.068" (1.73mm) 50 ksi (340 MPa)																																						
<input type="checkbox"/>	Reduced section strap -- fuse = 2.5" wide x 60" long -- ends = 3.75" wide 0.043" (1.09mm) 33 ksi (230 MPa)																																						
<input type="checkbox"/>	Reduced section strap -- fuse = 4" wide x 60" long -- ends = 6" wide 0.068" (1.73mm) 50 ksi (340 MPa)																																						
INTERIOR STUDS:	<table style="font-size: small;"> <tr><td><input type="checkbox"/></td><td>3-5/8"Wx1-5/8"Fx1/2"Lip 0.043" (1.09mm) 33ksi (230 Mpa)</td></tr> <tr><td><input checked="" type="checkbox"/></td><td>6"Wx1-5/8"Fx1/2"Lip 0.043" (1.09mm) 33ksi (230 Mpa)</td></tr> </table>		<input type="checkbox"/>	3-5/8"Wx1-5/8"Fx1/2"Lip 0.043" (1.09mm) 33ksi (230 Mpa)	<input checked="" type="checkbox"/>	6"Wx1-5/8"Fx1/2"Lip 0.043" (1.09mm) 33ksi (230 Mpa)	STUD SPACING:	<table style="font-size: small;"> <tr><td><input checked="" type="checkbox"/></td><td>16" O.C.</td></tr> <tr><td><input type="checkbox"/></td><td>Other :</td></tr> </table>	<input checked="" type="checkbox"/>	16" O.C.	<input type="checkbox"/>	Other :																											
<input type="checkbox"/>	3-5/8"Wx1-5/8"Fx1/2"Lip 0.043" (1.09mm) 33ksi (230 Mpa)																																						
<input checked="" type="checkbox"/>	6"Wx1-5/8"Fx1/2"Lip 0.043" (1.09mm) 33ksi (230 Mpa)																																						
<input checked="" type="checkbox"/>	16" O.C.																																						
<input type="checkbox"/>	Other :																																						
BACK-TO-BACK CHORD STUDS:	<table style="font-size: small;"> <tr><td><input type="checkbox"/></td><td>3-5/8"Wx1-5/8"Fx1/2"Lip 0.043" (1.09mm) 33ksi (230 Mpa)</td></tr> <tr><td><input type="checkbox"/></td><td>6"Wx1-5/8"Fx1/2"Lip 0.054" (1.37mm) 50ksi (345 Mpa)</td></tr> <tr><td><input checked="" type="checkbox"/></td><td>6"Wx1-5/8"Fx1/2"Lip 0.068" (1.73mm) 50ksi (345 Mpa)</td></tr> </table>				<input type="checkbox"/>	3-5/8"Wx1-5/8"Fx1/2"Lip 0.043" (1.09mm) 33ksi (230 Mpa)	<input type="checkbox"/>	6"Wx1-5/8"Fx1/2"Lip 0.054" (1.37mm) 50ksi (345 Mpa)	<input checked="" type="checkbox"/>	6"Wx1-5/8"Fx1/2"Lip 0.068" (1.73mm) 50ksi (345 Mpa)																													
<input type="checkbox"/>	3-5/8"Wx1-5/8"Fx1/2"Lip 0.043" (1.09mm) 33ksi (230 Mpa)																																						
<input type="checkbox"/>	6"Wx1-5/8"Fx1/2"Lip 0.054" (1.37mm) 50ksi (345 Mpa)																																						
<input checked="" type="checkbox"/>	6"Wx1-5/8"Fx1/2"Lip 0.068" (1.73mm) 50ksi (345 Mpa)																																						
CONNECTIONS:	<table style="font-size: small;"> <tr><td><input checked="" type="checkbox"/></td><td>No.10 gauge 0.75" self-drilling wafer head (mod. Truss) Phillips drive</td></tr> <tr><td><input checked="" type="checkbox"/></td><td>No.8 gauge 0.5" self-drilling wafer head (mod. Truss) Phillips drive</td></tr> <tr><td><input checked="" type="checkbox"/></td><td>No.14 gauge 1" self-drilling Hex washer head</td></tr> <tr><td><input checked="" type="checkbox"/></td><td>No.10 gauge 0.75" self-drilling Hex washer head</td></tr> <tr><td><input type="checkbox"/></td><td>7/8" A193 Rod</td></tr> <tr><td><input checked="" type="checkbox"/></td><td>1" A193 Rod</td></tr> <tr><td><input checked="" type="checkbox"/></td><td>A325 3/4" bolts</td></tr> <tr><td><input checked="" type="checkbox"/></td><td>A325 3/4" bolts</td></tr> </table>				<input checked="" type="checkbox"/>	No.10 gauge 0.75" self-drilling wafer head (mod. Truss) Phillips drive	<input checked="" type="checkbox"/>	No.8 gauge 0.5" self-drilling wafer head (mod. Truss) Phillips drive	<input checked="" type="checkbox"/>	No.14 gauge 1" self-drilling Hex washer head	<input checked="" type="checkbox"/>	No.10 gauge 0.75" self-drilling Hex washer head	<input type="checkbox"/>	7/8" A193 Rod	<input checked="" type="checkbox"/>	1" A193 Rod	<input checked="" type="checkbox"/>	A325 3/4" bolts	<input checked="" type="checkbox"/>	A325 3/4" bolts																			
<input checked="" type="checkbox"/>	No.10 gauge 0.75" self-drilling wafer head (mod. Truss) Phillips drive																																						
<input checked="" type="checkbox"/>	No.8 gauge 0.5" self-drilling wafer head (mod. Truss) Phillips drive																																						
<input checked="" type="checkbox"/>	No.14 gauge 1" self-drilling Hex washer head																																						
<input checked="" type="checkbox"/>	No.10 gauge 0.75" self-drilling Hex washer head																																						
<input type="checkbox"/>	7/8" A193 Rod																																						
<input checked="" type="checkbox"/>	1" A193 Rod																																						
<input checked="" type="checkbox"/>	A325 3/4" bolts																																						
<input checked="" type="checkbox"/>	A325 3/4" bolts																																						
TRACK:	<table style="font-size: small;"> <tr><td><input checked="" type="checkbox"/></td><td>Regular</td><td><input checked="" type="checkbox"/></td><td>6" web</td></tr> <tr><td><input type="checkbox"/></td><td>Extended</td><td><input type="checkbox"/></td><td>3 5/8" web</td></tr> <tr><td><input type="checkbox"/></td><td>Reinforced</td><td><input type="checkbox"/></td><td>1-1/4" flange</td></tr> </table>		<input checked="" type="checkbox"/>	Regular	<input checked="" type="checkbox"/>	6" web	<input type="checkbox"/>	Extended	<input type="checkbox"/>	3 5/8" web	<input type="checkbox"/>	Reinforced	<input type="checkbox"/>	1-1/4" flange	<table style="font-size: small;"> <tr><td><input type="checkbox"/></td><td>0.043" (1.09mm) 33ksi (230 Mpa)</td></tr> <tr><td><input type="checkbox"/></td><td>0.054" (1.37mm) 50ksi (345 Mpa)</td></tr> <tr><td><input checked="" type="checkbox"/></td><td>0.068" (1.73mm) 50ksi (345 Mpa)</td></tr> <tr><td><input type="checkbox"/></td><td>0.097" (1.73mm) 50ksi (345 Mpa)</td></tr> </table>		<input type="checkbox"/>	0.043" (1.09mm) 33ksi (230 Mpa)	<input type="checkbox"/>	0.054" (1.37mm) 50ksi (345 Mpa)	<input checked="" type="checkbox"/>	0.068" (1.73mm) 50ksi (345 Mpa)	<input type="checkbox"/>	0.097" (1.73mm) 50ksi (345 Mpa)															
<input checked="" type="checkbox"/>	Regular	<input checked="" type="checkbox"/>	6" web																																				
<input type="checkbox"/>	Extended	<input type="checkbox"/>	3 5/8" web																																				
<input type="checkbox"/>	Reinforced	<input type="checkbox"/>	1-1/4" flange																																				
<input type="checkbox"/>	0.043" (1.09mm) 33ksi (230 Mpa)																																						
<input type="checkbox"/>	0.054" (1.37mm) 50ksi (345 Mpa)																																						
<input checked="" type="checkbox"/>	0.068" (1.73mm) 50ksi (345 Mpa)																																						
<input type="checkbox"/>	0.097" (1.73mm) 50ksi (345 Mpa)																																						
HOLD DOWNS:	<table style="font-size: small;"> <tr><td><input type="checkbox"/></td><td>S/HD10S Simpson</td><td>inside</td><td>outside</td><td>raised</td></tr> <tr><td><input type="checkbox"/></td><td>Fabricated U-shape</td><td></td><td></td><td></td></tr> <tr><td><input type="checkbox"/></td><td>6" x 6" 0.054" (1.37mm) 50 ksi (340 MPa) Gusset Plate w/ S/HD15S Simpson</td><td></td><td></td><td></td></tr> <tr><td><input type="checkbox"/></td><td>7" x 9" 0.054" (1.37mm) 50 ksi (340 MPa) Gusset Plate w/ S/HD15S Simpson</td><td></td><td></td><td></td></tr> <tr><td><input checked="" type="checkbox"/></td><td>8" x 8" 0.068" (1.73mm) 50 ksi (340 MPa) Gusset Plate w/ S/HD15S Simpson</td><td><input checked="" type="checkbox"/></td><td></td><td></td></tr> <tr><td><input type="checkbox"/></td><td>8.5" x10" 0.068" (1.73mm) 50 ksi (340 MPa) Gusset Plate w/ S/HD15S Simpson</td><td></td><td></td><td></td></tr> <tr><td><input type="checkbox"/></td><td>10" x10" 0.054" (1.37mm) 50 ksi (340 MPa) Gusset Plate w/ S/HD15S Simpson</td><td></td><td></td><td></td></tr> </table>				<input type="checkbox"/>	S/HD10S Simpson	inside	outside	raised	<input type="checkbox"/>	Fabricated U-shape				<input type="checkbox"/>	6" x 6" 0.054" (1.37mm) 50 ksi (340 MPa) Gusset Plate w/ S/HD15S Simpson				<input type="checkbox"/>	7" x 9" 0.054" (1.37mm) 50 ksi (340 MPa) Gusset Plate w/ S/HD15S Simpson				<input checked="" type="checkbox"/>	8" x 8" 0.068" (1.73mm) 50 ksi (340 MPa) Gusset Plate w/ S/HD15S Simpson	<input checked="" type="checkbox"/>			<input type="checkbox"/>	8.5" x10" 0.068" (1.73mm) 50 ksi (340 MPa) Gusset Plate w/ S/HD15S Simpson				<input type="checkbox"/>	10" x10" 0.054" (1.37mm) 50 ksi (340 MPa) Gusset Plate w/ S/HD15S Simpson			
<input type="checkbox"/>	S/HD10S Simpson	inside	outside	raised																																			
<input type="checkbox"/>	Fabricated U-shape																																						
<input type="checkbox"/>	6" x 6" 0.054" (1.37mm) 50 ksi (340 MPa) Gusset Plate w/ S/HD15S Simpson																																						
<input type="checkbox"/>	7" x 9" 0.054" (1.37mm) 50 ksi (340 MPa) Gusset Plate w/ S/HD15S Simpson																																						
<input checked="" type="checkbox"/>	8" x 8" 0.068" (1.73mm) 50 ksi (340 MPa) Gusset Plate w/ S/HD15S Simpson	<input checked="" type="checkbox"/>																																					
<input type="checkbox"/>	8.5" x10" 0.068" (1.73mm) 50 ksi (340 MPa) Gusset Plate w/ S/HD15S Simpson																																						
<input type="checkbox"/>	10" x10" 0.054" (1.37mm) 50 ksi (340 MPa) Gusset Plate w/ S/HD15S Simpson																																						
TEST PROTOCOL AND DESCRIPTION:	<table style="font-size: small;"> <tr><td><input type="checkbox"/></td><td>Monotonic (Rate of Loading 2.5 mm/min)</td></tr> <tr><td><input checked="" type="checkbox"/></td><td>Cyclic (CUREE cyclic protocol)</td></tr> </table>				<input type="checkbox"/>	Monotonic (Rate of Loading 2.5 mm/min)	<input checked="" type="checkbox"/>	Cyclic (CUREE cyclic protocol)																															
<input type="checkbox"/>	Monotonic (Rate of Loading 2.5 mm/min)																																						
<input checked="" type="checkbox"/>	Cyclic (CUREE cyclic protocol)																																						
LVDT MEASUREMENTS:	<table style="font-size: small;"> <tr><td><input checked="" type="checkbox"/></td><td>Actuator LVDT</td></tr> <tr><td><input checked="" type="checkbox"/></td><td>North Slip</td></tr> <tr><td><input checked="" type="checkbox"/></td><td>South Slip</td></tr> </table>		<input checked="" type="checkbox"/>	Actuator LVDT	<input checked="" type="checkbox"/>	North Slip	<input checked="" type="checkbox"/>	South Slip	<table style="font-size: small;"> <tr><td><input checked="" type="checkbox"/></td><td>North Uplift</td></tr> <tr><td><input checked="" type="checkbox"/></td><td>South Uplift</td></tr> <tr><td><input checked="" type="checkbox"/></td><td>Top of Wall</td></tr> </table>		<input checked="" type="checkbox"/>	North Uplift	<input checked="" type="checkbox"/>	South Uplift	<input checked="" type="checkbox"/>	Top of Wall																							
<input checked="" type="checkbox"/>	Actuator LVDT																																						
<input checked="" type="checkbox"/>	North Slip																																						
<input checked="" type="checkbox"/>	South Slip																																						
<input checked="" type="checkbox"/>	North Uplift																																						
<input checked="" type="checkbox"/>	South Uplift																																						
<input checked="" type="checkbox"/>	Top of Wall																																						
				TOTAL: <input type="text" value="6"/>																																			
STRAP WIDTH BEFORE TEST:	<table style="font-size: small; width: 100%;"> <tr> <td style="width: 25%;">Front Right</td> <td style="width: 25%;">Front Left, mm</td> <td style="width: 25%;">Back Right, mm</td> <td style="width: 25%;">Back Left, mm</td> </tr> <tr> <td><input type="text" value="102.29"/></td> <td><input type="text" value="101.76"/></td> <td><input type="text" value="102.29"/></td> <td><input type="text" value="101.71"/></td> </tr> <tr> <td><input type="text" value="102.37"/></td> <td><input type="text" value="101.72"/></td> <td><input type="text" value="101.54"/></td> <td><input type="text" value="101.24"/></td> </tr> <tr> <td><input type="text" value="102.40"/></td> <td><input type="text" value="101.22"/></td> <td><input type="text" value="101.02"/></td> <td><input type="text" value="101.17"/></td> </tr> <tr> <td>AVG <input type="text" value="102.35"/> mm</td> <td>AVG <input type="text" value="101.57"/> mm</td> <td>AVG <input type="text" value="101.62"/> mm</td> <td>AVG <input type="text" value="101.37"/> mm</td> </tr> </table>				Front Right	Front Left, mm	Back Right, mm	Back Left, mm	<input type="text" value="102.29"/>	<input type="text" value="101.76"/>	<input type="text" value="102.29"/>	<input type="text" value="101.71"/>	<input type="text" value="102.37"/>	<input type="text" value="101.72"/>	<input type="text" value="101.54"/>	<input type="text" value="101.24"/>	<input type="text" value="102.40"/>	<input type="text" value="101.22"/>	<input type="text" value="101.02"/>	<input type="text" value="101.17"/>	AVG <input type="text" value="102.35"/> mm	AVG <input type="text" value="101.57"/> mm	AVG <input type="text" value="101.62"/> mm	AVG <input type="text" value="101.37"/> mm															
Front Right	Front Left, mm	Back Right, mm	Back Left, mm																																				
<input type="text" value="102.29"/>	<input type="text" value="101.76"/>	<input type="text" value="102.29"/>	<input type="text" value="101.71"/>																																				
<input type="text" value="102.37"/>	<input type="text" value="101.72"/>	<input type="text" value="101.54"/>	<input type="text" value="101.24"/>																																				
<input type="text" value="102.40"/>	<input type="text" value="101.22"/>	<input type="text" value="101.02"/>	<input type="text" value="101.17"/>																																				
AVG <input type="text" value="102.35"/> mm	AVG <input type="text" value="101.57"/> mm	AVG <input type="text" value="101.62"/> mm	AVG <input type="text" value="101.37"/> mm																																				
DATA ACQ. RECORD RATE:	100 scan/sec		MONITOR RATE:	100 scan/sec																																			
COMMENTS:	<ul style="list-style-type: none"> -Shear anchors torqued for 10 s with impact wrench -Hold down anchors 1/2 turn from finger tight (load cells used on both hold-downs) -Double chord studs used screwed back to back -Square plate washers (2.5"x2.5") used in all top track connections -Regular washers used in all bottom track connections 																																						

Figure E.41: Data sheet for test 24C-C

Test name : 24C-C
Date tested : 19-5-14-2007
Wall Size : 2x8
Strap Size : 4"
Extended Track : yes no
Holddown : Inside Outside
Test made : Cyclic Monotonic

Front side notes:
No load cells used in test @ anchor locations.

Est sawtooth crushing of chord studs here.

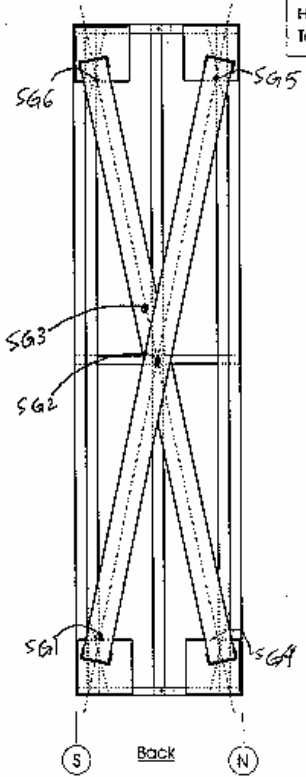
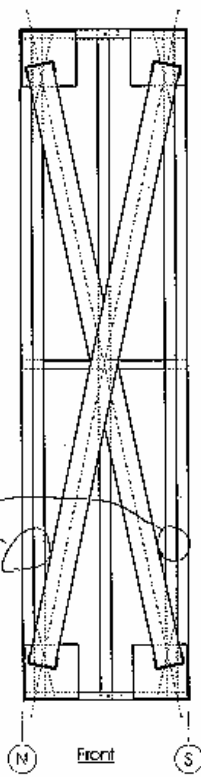

Back side notes:
Note change of position of strain gauges.

Screw in push dir strap.

Figure E.42: Observations for test 24C-C

Appendix F

Model Design Summaries

Table F.1: Summary of design storey shear for building 2S R_dR₀2.6-minbrace^a

Storey	W _i (kN)	h _i (m)	W _i x h _i	F _x (kN)	T _x (kN)	N _x (kN)	V _{fx} (kN)	ΣV _{fx} (kN)
2.0	241.7	6.71	1621.9	86.8	8.7	1.2	96.7	96.7
1.0	630.6	3.66	2308.1	123.5	12.3	4.2	140.0	236.7
<i>Sum</i>	<i>872.3</i>	-	<i>3930.0</i>	<i>210.3</i>	-	-	<i>236.7</i>	-

^aVariables defined in Section 3.1

Table F.2: Summary of design storey shear for building 4S R_dR₀2.6-minbrace^a

Storey	W _i (kN)	h _i (m)	W _i x h _i	F _x (kN)	T _x (kN)	N _x (kN)	V _{fx} (kN)	ΣV _{fx} (kN)
4.0	241.7	12.81	3096.3	89.0	8.9	1.2	99.1	99.1
3.0	630.6	9.76	6155.0	176.9	17.7	4.2	198.8	298.0
2.0	630.6	6.71	4231.6	121.7	12.2	4.2	138.0	436.0
1.0	630.6	3.66	2308.1	66.4	6.6	4.2	77.2	513.2
<i>Sum</i>	<i>2133.6</i>	-	<i>15791.0</i>	<i>454.0</i>	-	-	<i>513.2</i>	-

^aVariables defined in Section 3.1

Table F.3: Summary of design storey shear for building 6S R_dR₀2.6-minbrace and 6S

R_dR₀2.6-2brace^a

Storey	W _i (kN)	h _i (m)	W _i x h _i	F _x (kN)	T _x (kN)	N _x (kN)	V _{fx} (kN)	ΣV _{fx} (kN)
6	241.7	18.91	4570.7	88.9	8.9	1.2	99.0	99.0
5	630.6	15.86	10001.9	125.6	12.6	4.2	142.4	241.4
4	630.6	12.81	8078.5	101.5	10.1	4.2	115.8	357.2
3	630.6	9.76	6155.0	77.3	7.7	4.2	89.2	446.4
2	630.6	6.71	4231.6	53.1	5.3	4.2	62.7	509.1
1	630.6	3.66	2308.1	29.0	2.9	4.2	36.1	545.2
<i>Sum</i>	<i>3394.9</i>	-	<i>35345.8</i>	<i>475.4</i>	-	-	<i>545.2</i>	-

^aVariables defined in Section 3.1

Table F.4: Summary of design storey shear for building 6S R_dR_o4-minbrace^a

Storey	W _i (kN)	h _i (m)	W _i x h _i	F _x (kN)	T _x (kN)	N _x (kN)	V _{fx} (kN)	ΣV _{fx} (kN)
6	241.7	18.91	4570.7	57.8	5.8	1.2	64.8	64.8
5	630.6	15.86	10001.9	81.7	8.2	4.2	94.0	158.8
4	630.6	12.81	8078.5	66.0	6.6	4.2	76.7	235.5
3	630.6	9.76	6155.0	50.3	5.0	4.2	59.5	295.0
2	630.6	6.71	4231.6	34.5	3.5	4.2	42.2	337.2
1	630.6	3.66	2308.1	18.8	1.9	4.2	24.9	362.1
Sum	3394.9	-	35345.8	309.0	-	-	362.1	-

^aVariables defined in Section 3.1**Table F.5: Summary of design storey shear for building 7S R_dR_o2.6-minbrace and 7S R_dR_o2.6-2brace^a**

Storey	W _i (kN)	h _i (m)	W _i x h _i	F _x (kN)	T _x (kN)	N _x (kN)	V _{fx} (kN)	ΣV _{fx} (kN)
7	241.7	21.96	5307.9	87.1	8.7	1.2	97.0	97.0
6	630.6	18.91	11925.3	111.6	11.2	4.2	127.0	223.9
5	630.6	15.86	10001.9	93.6	9.4	4.2	107.2	331.1
4	630.6	12.81	8078.5	75.6	7.6	4.2	87.4	418.4
3	630.6	9.76	6155.0	57.6	5.8	4.2	67.6	486.0
2	630.6	6.71	4231.6	39.6	4.0	4.2	47.8	533.8
1	630.6	3.66	2308.1	21.6	2.2	4.2	28.0	561.7
Sum	4025.5	-	48008.3	486.7	-	-	561.7	-

^aVariables defined in Section 3.1**Table F.6: Summary of design storey shear for building 7S R_dR_o4-minbrace^a**

Storey	W _i (kN)	h _i (m)	W _i x h _i	F _x (kN)	T _x (kN)	N _x (kN)	V _{fx} (kN)	ΣV _{fx} (kN)
7.0	241.7	21.96	5307.9	56.6	5.7	1.2	63.5	63.5
6.0	630.6	18.91	11925.3	72.5	7.3	4.2	84.0	147.5
5.0	630.6	15.86	10001.9	60.8	6.1	4.2	71.1	218.6
4.0	630.6	12.81	8078.5	49.1	4.9	4.2	58.2	276.8
3.0	630.6	9.76	6155.0	37.4	3.7	4.2	45.4	322.2
2.0	630.6	6.71	4231.6	25.7	2.6	4.2	32.5	354.7
1.0	630.6	3.66	2308.1	14.0	1.4	4.2	19.6	374.3
Sum	4025.5	-	48008.3	316.3	-	-	374.3	-

^aVariables defined in Section 3.1

Table F.7: Design summary for stick models

Model Name		Storey	Design parameters ^a						Modeling parameters ^b		
			ΣV_{fx} (kN)	t (mm)	b (mm)	b _{design} (in)	Δ_{mx} (mm)	k (kN/mm)	k _o (kN/mm)	S _{yc} (kN)	r
2S	R _d R _o 2.6- minbrace	2	96.7	1.37	74.5	2.5	18.4	3.90	3.12	46.1	0.0198
		1	236.7		203.6	6.0	26.1	5.79	4.63	99.0	0.0134
4S	R _d R _o 2.6 -minbrace	4	99.1	1.73	45.8	2.5	9.0	4.73	3.78	58.0	0.0164
		3	298.0		137.7	3.5	19.3	6.19	4.95	81.2	0.0125
		2	436.0		201.5	5.0	19.8	8.05	6.44	116.0	0.0096
		1	513.2		264.8	6.0	27.0	6.83	5.46	124.7	0.0113
6S	R _d R _o 2.6- minbrace	6	99.0	1.73	45.7	2.5	9.0	4.73	3.78	58.0	0.0164
		5	241.4		111.5	3.0	18.2	5.48	4.39	69.6	0.0141
		4	357.2		165.1	4.0	20.2	6.85	5.48	92.8	0.0113
		3	446.4		206.3	5.0	20.2	8.05	6.44	116.0	0.0096
		2	509.1		235.3	5.5	21.0	8.59	6.88	127.6	0.0090
		1	545.1		281.3	6.5	26.5	7.21	5.77	135.1	0.0107
	R _d R _o 2.6- 2brace	6	99.0	1.73	26.5	4.5	5.0	7.47	5.97	104.4	0.0104
		5	241.4		64.6	4.5	12.1	7.47	5.97	104.4	0.0104
		4	357.2		95.6	4.5	18.0	7.47	5.97	104.4	0.0104
		3	446.4		119.4	6.5	15.6	9.60	7.68	150.8	0.0081
		2	509.1		136.2	6.5	17.7	9.60	7.68	150.8	0.0081
		1	545.1		162.9	6.5	26.5	7.21	5.77	135.1	0.0107
R _d R _o 4- minbrace	6	64.8	1.37	21.8	2.5	11.4	3.90	3.12	46.1	0.0198	
	5	158.8		53.5	2.5	27.9	3.90	3.12	46.1	0.0198	
	4	235.5		79.4	3.5	29.5	5.16	4.13	64.5	0.0150	
	3	295.0		99.4	4.0	32.4	5.74	4.59	73.7	0.0135	
	2	337.2		113.6	4.5	32.9	6.29	5.03	82.9	0.0123	
	1	362.1		136.2	5.5	40.2	5.43	4.34	90.8	0.0143	

^aDesign parameters (further explanation available in Section 3.1): ΣV_{fx} = cumulative design storey shear, t = brace thickness, b = initial brace width, b_{design} = rounded design brace width, Δ_{mx} = inelastic inter-storey deflection, k = design brace stiffness

^bModeling parameters (further explanation available in Section 3.2): k_o = model brace stiffness, S_{yc} = capacity design yield load, r = post yield slope factor

Table F.7 cont'd: Design summary for stick models

Model Name	Storey	Design parameters						Modeling parameters			
		ΣV_{fx} (kN)	t (mm)	b (mm)	b_{design} (in)	Δ_{mx} (mm)	k (kN/mm)	k_o (kN/mm)	S_{yc} (kN)	r	
7S	R _d R _o 2.6- minbrace	7	97.0	1.73	37.4	2.5	7.3	4.73	3.78	58.0	0.0164
		6	223.9		86.2	2.5	16.9	4.73	3.78	58.0	0.0164
		5	331.1		127.5	3.0	20.8	5.48	4.39	69.6	0.0141
		4	418.4		161.2	4.0	19.7	6.85	5.48	92.8	0.0113
		3	486.0		187.2	4.5	20.4	7.47	5.97	104.4	0.0104
		2	533.8		205.6	5.0	20.1	8.05	6.44	116.0	0.0096
		1	561.7		241.6	5.5	26.8	6.42	5.14	114.3	0.0120
	R _d R _o 2.6- 2brace	7	97.0	1.73	21.6	3.5	5.2	6.19	4.95	81.2	0.0125
		6	223.9		49.9	3.5	12.1	6.19	4.95	81.2	0.0125
		5	331.1		73.8	3.5	17.9	6.19	4.95	81.2	0.0125
		4	418.4		93.3	5.5	14.4	8.59	6.88	127.6	0.0090
		3	486.0		108.4	5.5	16.7	8.59	6.88	127.6	0.0090
		2	533.8		119.0	5.5	18.3	8.59	6.88	127.6	0.0090
		1	561.7		139.9	5.5	26.8	6.42	5.14	114.3	0.0120
	R _d R _o 4- minbrace	7	63.5	1.37	21.4	2.5	11.1	3.90	3.12	46.1	0.0198
		6	147.5		49.7	2.5	25.9	3.90	3.12	46.1	0.0198
		5	218.6		73.6	3.0	32.0	4.55	3.64	55.3	0.0170
		4	276.8		93.3	4.0	30.4	5.74	4.59	73.7	0.0135
		3	322.2		108.6	4.5	31.4	6.29	5.03	82.9	0.0123
		2	354.7		119.5	5.0	31.1	6.81	5.45	92.1	0.0114
		1	374.3		140.9	5.5	41.6	5.43	4.34	90.8	0.0143

^aDesign parameters (further explanation available in Section 3.1): ΣV_{fx} = cumulative design storey shear, t = brace thickness, b = initial brace width, b_{design} = rounded design brace width, Δ_{mx} = inelastic inter-storey deflection, k = design brace stiffness

^bModeling parameters (further explanation available in Section 3.2): k_o = model brace stiffness, S_{yc} = capacity design yield load, r = post yield slope factor

Table F. 8: Design summary for full brace/chord stud model

Model Name	Storey	Modeling parameters ^{a, b}			
		k_o (Local X direction) (kN/mm)	S_{yc} (kN)	r	Chord stud stiffness, k (kN/mm)
6S R _d R _o 2.6- minbrace sized 100% full brace/chord stud	6	9.46	82.0	0.0033	178.88
	5	10.97	98.4	0.0028	218.71
	4	13.69	131.3	0.0023	157.73
	3	16.09	164.1	0.0019	157.73
	2	17.19	180.5	0.0018	94.61
	1	17.98	213.3	0.0014	94.61

^aDesign parameters are the same as model 6S R_dR_o2.6-minbrace (given in Table F.7)

^bModeling parameters (further explanation available in Section 3.2): k_o = model brace stiffness, S_{yc} = capacity design yield load, r = post yield slope factor, chord stud stiffness, k, represents the axial chord stud stiffness

Appendix G

RUAUMOKO Input Files

```

5.81 0.0107 97.79 -97.79      !KX RF FX+ FX- (from test 24A-C results)
5                               !5 = Bi-linear with slackness Hysteresis Model
0                               !0 = No Strength Degradation (Not available)
0.0 0.0 0.0 0.0107 0.0 0.0 0  !GAP+ GAP- IMODE R C EPSO ILOG
0                               !ILOS (=0, no strength degradation)
0                               !DINIT (initial displacement)
3 1                             !IHIST SCALE
0.014890963                   !Incremental test result displacement history (test 24A-C)
-0.010920039
-0.007941847
0.007941847
-0.007941847
0.003970923
0.003970923
-0.007941847
0.01191277
-0.007941847
0.003970923
-0.007941847
-0.014890963
-0.014890963
-0.026803733
-0.022832809
-0.045665619
-0.048643811
-0.053607466
-0.060556582
-0.063534774
-0.080411198
-0.067505697
-0.079418468
-0.072469352
cont'd... (remaining values not shown)

```

Figure G.1: HYSTERES input file for hysteretic behaviour matching, based on test 24A-C

```

6 storey shear wall Rd=2    Ro=1.3          ! Units kN, m and s
2 0 1 0 0 0 1 0 0          ! Principal Analysis Options
14 12 7 6 1 2 9.81 5 5 0.002 55.495 1      ! Frame Control Parameters
0 1 1 0 1                  ! Output Intervals and Plotting Control Parameters
0 0                        ! Iteration Control

```

NODES

1	0	0	1	1	1	0	0	0	3
2	0	3.66	0	0	1	0	0	0	0
3	0	6.71	0	0	1	0	0	0	0
4	0	9.76	0	0	1	0	0	0	0
5	0	12.81	0	0	1	0	0	0	0
6	0	15.86	0	0	1	0	0	0	0
7	0	18.91	0	0	1	0	0	0	0
8	3	0	1	1	1	0	0	0	3
9	3	3.66	0	0	1	2	0	0	0
10	3	6.71	0	0	1	3	0	0	0
11	3	9.76	0	0	1	4	0	0	0
12	3	12.81	0	0	1	5	0	0	0
13	3	15.86	0	0	1	6	0	0	0
14	3	18.91	0	0	1	7	0	0	0

ELEMENTS

1	1	1	2	0	0	0
2	2	2	3	0	0	0
3	3	3	4	0	0	0
4	4	4	5	0	0	0
5	5	5	6	0	0	0
6	6	6	7	0	0	0
7	7	8	9	0	0	0
8	7	9	10	0	0	0
9	7	10	11	0	0	0
10	7	11	12	0	0	0
11	7	12	13	0	0	0
12	7	13	14	0	0	0

Figure G.2: RUAUMOKO input file for model 6S R_dR_o2.6-minbrace

```

PROPS
1    SPRING
1 5 0 0 1000000 5766.761887 0 0 0.010730518 ! brace: t=0.068in w=6.5in
Degradation,IDAMG,Kx,Ky,GJ,WGT,RF ! Itype 1, Ihyst = BILINEAR WITH SLACKNESS,Ilos = No Strength
1000000 -1000000 135.07 -135.07 ! Fy+ Fy- FX+ FX-
0.0 0.0 0 0.010730518 0.0 0.0 0 ! GAP+ GAP- IMODE RCOMP C EPSO ILOG
2    SPRING
1 5 0 0 1000000 6875.311591 0 0 0.009000369 ! brace: t=0.068in w=5.5in
Degradation,IDAMG,Kx,Ky,GJ,WGT,RF ! Itype 1, Ihyst = BILINEAR WITH SLACKNESS,Ilos = No Strength
1000000 -1000000 127.62 -127.62 ! Fy+ Fy- FX+ FX-
0.0 0.0 0 0.009000369 0.0 0.0 0 ! GAP+ GAP- IMODE RCOMP C EPSO ILOG
3    SPRING
1 5 0 0 1000000 6437.17085 0 0 0.009612971 ! brace: t=0.068in w=5in
Degradation,IDAMG,Kx,Ky,GJ,WGT,RF ! Itype 1, Ihyst = BILINEAR WITH SLACKNESS,Ilos = No Strength
1000000 -1000000 116.02 -116.02 ! Fy+ Fy- FX+ FX-
0.0 0.0 0 0.009612971 0.0 0.0 0 ! GAP+ GAP- IMODE RCOMP C EPSO ILOG
4    SPRING
1 5 0 0 1000000 5477.285572 0 0 0.011297629 ! brace: t=0.068in w=4in
Degradation,IDAMG,Kx,Ky,GJ,WGT,RF ! Itype 1, Ihyst = BILINEAR WITH SLACKNESS,Ilos = No Strength
1000000 -1000000 92.82 -92.82 ! Fy+ Fy- FX+ FX-
0.0 0.0 0 0.011297629 0.0 0.0 0 ! GAP+ GAP- IMODE RCOMP C EPSO ILOG
5    SPRING
1 5 0 0 1000000 4386.999168 0 0 0.014105391 ! brace: t=0.068in w=3in
Degradation,IDAMG,Kx,Ky,GJ,WGT,RF ! Itype 1, Ihyst = BILINEAR WITH SLACKNESS,Ilos = No Strength
1000000 -1000000 69.61 -69.61 ! Fy+ Fy- FX+ FX-
0.0 0.0 0 0.014105391 0.0 0.0 0 ! GAP+ GAP- IMODE RCOMP C EPSO ILOG
6    SPRING
1 5 0 0 1000000 3784.359656 0 0 0.016351601 ! brace: t=0.068in w=2.5in
Degradation,IDAMG,Kx,Ky,GJ,WGT,RF ! Itype 1, Ihyst = BILINEAR WITH SLACKNESS,Ilos = No Strength
1000000 -1000000 58.01 -58.01 ! Fy+ Fy- FX+ FX-
0.0 0.0 0 0.016351601 0.0 0.0 0 ! GAP+ GAP- IMODE RCOMP C EPSO ILOG
7    SPRING
1 0 0 0 1000000

```

Figure G.2 cont'd: RUAUMOKO input file for model 6S R_dR_o2.6-minbrace

```
WEIGHT
1      0
2     126.127316
3     126.127316
4     126.127316
5     126.127316
6     126.127316
7     48.34148
8      0
9      0
10     0
11     0
12     0
13     0
14     0

LOAD
1      0      0      0
2      0      0      0
3      0      0      0
4      0      0      0
5      0      0      0
6      0      0      0
7      0      0      0
8      0      0      0
9      0     -147.5  0
10     0     -147.5  0
11     0     -147.5  0
12     0     -147.5  0
13     0     -147.5  0
14     0     -48.3   0

EQUAKE
3      1      0.005  1      55.495  0 0 1.0

START
```

Figure G.2 cont'd: RUAUMOKO input file for model 6S R_dR_o2.6-minbrace

```

6      storey shear wall  Rd=2  Ro=1.3      ! Units kN, m and s
2 0 1 0 0 0 1 0 0      ! Principal Analysis Options
33 54 14 6 1 2 9.81 5 5 0.002 60.0 1      ! Frame Control Parameters
0 0 1 0 1      ! Output Intervals and Plotting Control Parameters
0 0      ! Iteration Control
NODES
1      0      0      1      1      1      0      0      0      3
2      0      3.35  0      0      1      0      0      0      0
3      0      3.66  0      0      1      2      0      0      0
4      0      6.4   0      0      1      0      0      0      0
5      0      6.71  0      0      1      4      0      0      0
6      0      9.45  0      0      1      0      0      0      0
7      0      9.76  0      0      1      6      0      0      0
8      0      12.5  0      0      1      0      0      0      0
9      0      12.81 0      0      1      8      0      0      0
10     0      15.55 0      0      1      0      0      0      0
11     0      15.86 0      0      1      10     0      0      0
12     0      18.6  0      0      1      0      0      0      0
13     0      18.91 0      0      1      12     0      0      0
14     2.74  0      1      1      1      0      0      0      3
15     2.74  3.35  0      0      1      0      0      0      0
16     2.74  3.66  0      0      1      15     0      0      0
17     2.74  6.4   0      0      1      0      0      0      0
18     2.74  6.71  0      0      1      17     0      0      0
19     2.74  9.45  0      0      1      0      0      0      0
20     2.74  9.76  0      0      1      19     0      0      0
21     2.74  12.5  0      0      1      0      0      0      0
22     2.74  12.81 0      0      1      21     0      0      0
23     2.74  15.55 0      0      1      0      0      0      0
24     2.74  15.86 0      0      1      23     0      0      0
25     2.74  18.6  0      0      1      0      0      0      0
26     2.74  18.91 0      0      1      25     0      0      0
27     4      0      1      1      1      0      0      0      3
28     4      3.66  0      0      1      16     0      0      0
29     4      6.71  0      0      1      18     0      0      0
30     4      9.76  0      0      1      20     0      0      0

```

Figure G.3 : RUAUMOKO input file for full brace/chord stud model (6S $R_d R_o = 2.6$ -minbrace)

31	4	12.81	0	0	1	22	0	0	0
32	4	15.86	0	0	1	24	0	0	0
33	4	18.91	0	0	1	26	0	0	0
ELEMENTS									
1	1	1	2	0	0	0			
2	2	3	4	0	0	0			
3	3	5	6	0	0	0			
4	4	7	8	0	0	0			
5	5	9	10	0	0	0			
6	6	11	12	0	0	0			
7	1	14	15	0	0	0			
8	2	16	17	0	0	0			
9	3	18	19	0	0	0			
10	4	20	21	0	0	0			
11	5	22	23	0	0	0			
12	6	24	25	0	0	0			
13	7	2	15	0	0	0			
14	7	4	17	0	0	0			
15	7	6	19	0	0	0			
16	7	8	21	0	0	0			
17	7	10	23	0	0	0			
18	7	12	25	0	0	0			
19	8	1	15	0	0	0			
20	8	14	2	0	0	0			
21	9	3	17	0	0	0			
22	9	16	4	0	0	0			
23	10	5	19	0	0	0			
24	10	18	6	0	0	0			
25	11	7	21	0	0	0			
26	11	20	8	0	0	0			
27	12	9	23	0	0	0			
28	12	22	10	0	0	0			
29	13	11	25	0	0	0			
30	13	24	12	0	0	0			
31	14	27	28	0	0	0			
32	14	28	29	0	0	0			

Figure G.3 cont'd: RUAUMOKO input file for full brace/chord stud model (6S $R_d R_o = 2.6$ -minbrace)

33	14	29	30	0	0	0
34	14	30	31	0	0	0
35	14	31	32	0	0	0
36	14	32	33	0	0	0
37	7	2	3	0	0	0
38	7	4	5	0	0	0
39	7	6	7	0	0	0
40	7	8	9	0	0	0
41	7	10	11	0	0	0
42	7	12	13	0	0	0
43	7	15	16	0	0	0
44	7	17	18	0	0	0
45	7	19	20	0	0	0
46	7	21	22	0	0	0
47	7	23	24	0	0	0
48	7	25	26	0	0	0
49	7	3	16	0	0	0
50	7	5	18	0	0	0
51	7	7	20	0	0	0
52	7	9	22	0	0	0
53	7	11	24	0	0	0
54	7	13	26	0	0	0
PROPS						
1	SPRING					! Chord Stud
	1 0 0 0 178880					
2	SPRING					! Chord Stud
	1 0 0 0 218710					
3	SPRING					! Chord Stud
	1 0 0 0 157730					
4	SPRING					! Chord Stud
	1 0 0 0 157730					
5	SPRING					! Chord Stud
	1 0 0 0 94610					
6	SPRING					! Chord Stud
	1 0 0 0 94610					

Figure G.3 cont'd: RUAUMOKO input file for full brace/chord stud model (6S $R_d R_o = 2.6$ -minbrace)

```

7      SPRING                                ! Top Track (Axial stiffness = infinity)
      1 0 0 0 100000000
8      SPRING                                ! brace:
      1 5 0 0 17977.88018    0 0 0    0.001380123    ! Itype 1, Ihyst = BILINEAR WITH SLACKNESS,Ilos = No Strength
Degradation,IDAMG,Kx,Ky,GJ,WGT,RF
      213.3   -0.0001                                ! Fx+ Fx-
      0.0 0.0 0 0    0.0 0.0 0    ! GAP+ GAP- IMODE RCOMP C EPSO ILOG
9      SPRING                                ! brace:
      1 5 0 0 17188.27898    0 0 0    0.001800074    ! Itype 1, Ihyst = BILINEAR WITH SLACKNESS,Ilos = No Strength
Degradation,IDAMG,Kx,Ky,GJ,WGT,RF
      180.48  -0.0001                                ! Fx+ Fx-
      0.0 0.0 0 0    0.0 0.0 0    ! GAP+ GAP- IMODE RCOMP C EPSO ILOG
10     SPRING                                ! brace:
      1 5 0 0 16092.92713    0 0 0    0.001922594    ! Itype 1, Ihyst = BILINEAR WITH SLACKNESS,Ilos = No Strength
Degradation,IDAMG,Kx,Ky,GJ,WGT,RF
      164.08  -0.0001                                ! Fx+ Fx-
      0.0 0.0 0 0    0.0 0.0 0    ! GAP+ GAP- IMODE RCOMP C EPSO ILOG
11     SPRING                                ! brace:
      1 5 0 0 13693.21393    0 0 0    0.002259526    ! Itype 1, Ihyst = BILINEAR WITH SLACKNESS,Ilos = No Strength
Degradation,IDAMG,Kx,Ky,GJ,WGT,RF
      131.26  -0.0001                                ! Fx+ Fx-
      0.0 0.0 0 0    0.0 0.0 0    ! GAP+ GAP- IMODE RCOMP C EPSO ILOG
12     SPRING                                ! brace:
      1 5 0 0 10967.49792    0 0 0    0.002821078    ! Itype 1, Ihyst = BILINEAR WITH SLACKNESS,Ilos = No Strength
Degradation,IDAMG,Kx,Ky,GJ,WGT,RF
      98.45   -0.0001                                ! Fx+ Fx-
      0.0 0.0 0 0    0.0 0.0 0    ! GAP+ GAP- IMODE RCOMP C EPSO ILOG
13     SPRING                                ! brace:
      1 5 0 0 9460.899139    0 0 0    0.00327032    ! Itype 1, Ihyst = BILINEAR WITH SLACKNESS,Ilos = No Strength
Degradation,IDAMG,Kx,Ky,GJ,WGT,RF
      82.04   -0.0001                                ! Fx+ Fx-
      0.0 0.0 0 0    0.0 0.0 0    ! GAP+ GAP- IMODE RCOMP C EPSO ILOG
14     SPRING                                ! P-Delta Column
      1 0 0 0 100000000
WEIGHT
1      0

```

Figure G.3 cont'd: RUAUMOKO input file for full brace/chord stud model (6S $R_d R_o = 2.6$ -minbrace)

```
2      0
3     63.063658
4      0
5     63.063658
6      0
7     63.063658
8      0
9     63.063658
10     0
11    63.063658
12     0
13    24.17074
14     0
15     0
16    63.063658
17     0
18    63.063658
19     0
20    63.063658
21     0
22    63.063658
23     0
24    63.063658
25     0
26    24.17074
27     0
28     0
29     0
30     0
31     0
32     0
33     0
LOAD
1      0      0      0
2      0      0      0
```

Figure G.3 cont'd: RUAUMOKO input file for full brace/chord stud model (6S $R_d R_o = 2.6$ -minbrace)

```
3      0      0      0
4      0      0      0
5      0      0      0
6      0      0      0
7      0      0      0
8      0      0      0
9      0      0      0
10     0      0      0
11     0      0      0
12     0      0      0
13     0      0      0
14     0      0      0
15     0      0      0
16     0      0      0
17     0      0      0
18     0      0      0
19     0      0      0
20     0      0      0
21     0      0      0
22     0      0      0
23     0      0      0
24     0      0      0
25     0      0      0
26     0      0      0
27     0      0      0
28     0     -147.5  0
29     0     -147.5  0
30     0     -147.5  0
31     0     -147.5  0
32     0     -147.5  0
33     0     -48.3   0
EQUAKE
3 1    0.005    1    60.0    0 0 1.0
START
```

Figure G.3 cont'd: RUAUMOKO input file for full brace/chord stud model (6S $R_d R_o = 2.6$ -minbrace)

```

6 storey shear wall Rd=2    Ro=1.3          ! Units kN, m and s
2 0 1 0 0 -1 1 0 0         ! Principal Analysis Options
14 12 7 6 1 2 9.81 5 5 0.002 20.0 1       ! Frame Control Parameters
0 1 1 0 1                 ! Output Intervals and Plotting Control Parameters
0 0                       ! Iteration Control

```

NODES

1	0	0	1	1	1	0	0	0	3
2	0	3.66	0	0	1	0	0	0	0
3	0	6.71	0	0	1	0	0	0	0
4	0	9.76	0	0	1	0	0	0	0
5	0	12.81	0	0	1	0	0	0	0
6	0	15.86	0	0	1	0	0	0	0
7	0	18.91	0	0	1	0	0	0	0
8	3	0	1	1	1	0	0	0	3
9	3	3.66	0	0	1	2	0	0	0
10	3	6.71	0	0	1	3	0	0	0
11	3	9.76	0	0	1	4	0	0	0
12	3	12.81	0	0	1	5	0	0	0
13	3	15.86	0	0	1	6	0	0	0
14	3	18.91	0	0	1	7	0	0	0

ELEMENTS

1	1	1	2	0	0	0
2	2	2	3	0	0	0
3	3	3	4	0	0	0
4	4	4	5	0	0	0
5	5	5	6	0	0	0
6	6	6	7	0	0	0
7	7	8	9	0	0	0
8	7	9	10	0	0	0
9	7	10	11	0	0	0
10	7	11	12	0	0	0
11	7	12	13	0	0	0
12	7	13	14	0	0	0

Figure G.4: RUAUMOKO input file for pushover analysis, model 6S $R_d R_o 2.6$ -minbrace

```

PROPS
1    SPRING
1 5 0 0 1000000 5766.761887 0 0 0.010730518 ! brace: t=0.068in w=6.5in
Degradation,IDAMG,Kx,Ky,GJ,WGT,RF ! Itype 1, Ihyst = BILINEAR WITH SLACKNESS,Ilos = No Strength
1000000 -1000000 135.07 -135.07 ! Fy+ Fy- FX+ FX-
0.0 0.0 0 0.010730518 0.0 0.0 0 ! GAP+ GAP- IMODE RCOMP C EPSO ILOG
2    SPRING
1 5 0 0 1000000 6875.311591 0 0 0.009000369 ! brace: t=0.068in w=5.5in
Degradation,IDAMG,Kx,Ky,GJ,WGT,RF ! Itype 1, Ihyst = BILINEAR WITH SLACKNESS,Ilos = No Strength
1000000 -1000000 127.62 -127.62 ! Fy+ Fy- FX+ FX-
0.0 0.0 0 0.009000369 0.0 0.0 0 ! GAP+ GAP- IMODE RCOMP C EPSO ILOG
3    SPRING
1 5 0 0 1000000 6437.17085 0 0 0.009612971 ! brace: t=0.068in w=5in
Degradation,IDAMG,Kx,Ky,GJ,WGT,RF ! Itype 1, Ihyst = BILINEAR WITH SLACKNESS,Ilos = No Strength
1000000 -1000000 116.02 -116.02 ! Fy+ Fy- FX+ FX-
0.0 0.0 0 0.009612971 0.0 0.0 0 ! GAP+ GAP- IMODE RCOMP C EPSO ILOG
4    SPRING
1 5 0 0 1000000 5477.285572 0 0 0.011297629 ! brace: t=0.068in w=4in
Degradation,IDAMG,Kx,Ky,GJ,WGT,RF ! Itype 1, Ihyst = BILINEAR WITH SLACKNESS,Ilos = No Strength
1000000 -1000000 92.82 -92.82 ! Fy+ Fy- FX+ FX-
0.0 0.0 0 0.011297629 0.0 0.0 0 ! GAP+ GAP- IMODE RCOMP C EPSO ILOG
5    SPRING
1 5 0 0 1000000 4386.999168 0 0 0.014105391 ! brace: t=0.068in w=3in
Degradation,IDAMG,Kx,Ky,GJ,WGT,RF ! Itype 1, Ihyst = BILINEAR WITH SLACKNESS,Ilos = No Strength
1000000 -1000000 69.61 -69.61 ! Fy+ Fy- FX+ FX-
0.0 0.0 0 0.014105391 0.0 0.0 0 ! GAP+ GAP- IMODE RCOMP C EPSO ILOG
6    SPRING
1 5 0 0 1000000 3784.359656 0 0 0.016351601 ! brace: t=0.068in w=2.5in
Degradation,IDAMG,Kx,Ky,GJ,WGT,RF ! Itype 1, Ihyst = BILINEAR WITH SLACKNESS,Ilos = No Strength
1000000 -1000000 58.01 -58.01 ! Fy+ Fy- FX+ FX-
0.0 0.0 0 0.016351601 0.0 0.0 0 ! GAP+ GAP- IMODE RCOMP C EPSO ILOG
7    SPRING
1 0 0 0 1000000

```

Figure G.4 cont'd: RUAUMOKO input file for pushover analysis, model 6S R₁R₂2.6-minbrace

```
WEIGHT
1      0
2      1
3      1
4      1
5      1
6      1
7      1
8      0
9      0
10     0
11     0
12     0
13     0
14     0

LOAD
1      0      0      0
2      0      0      0
3      0      0      0
4      0      0      0
5      0      0      0
6      0      0      0
7      0      0      0
8      0      0      0
9      0      -147.5  0
10     0      -147.5  0
11     0      -147.5  0
12     0      -147.5  0
13     0      -147.5  0
14     0      -48.3   0
```

Figure G.4 cont'd: RUAUMOKO input file for pushover analysis, model 6S R_dR_o2.6-minbrace

```
SHAPE
2      0.061
3      0.112
4      0.163
5      0.213
6      0.264
7      0.187

EQUAKE
3

START
1 0 0
2 20 130
```

Figure G.4 cont'd: RUAUMOKO input file for pushover analysis, model 6S R_dR_o2.6-minbrace

Appendix H

Example Hystereses and Time Histories for Closely Matched (CM) Ground Motion

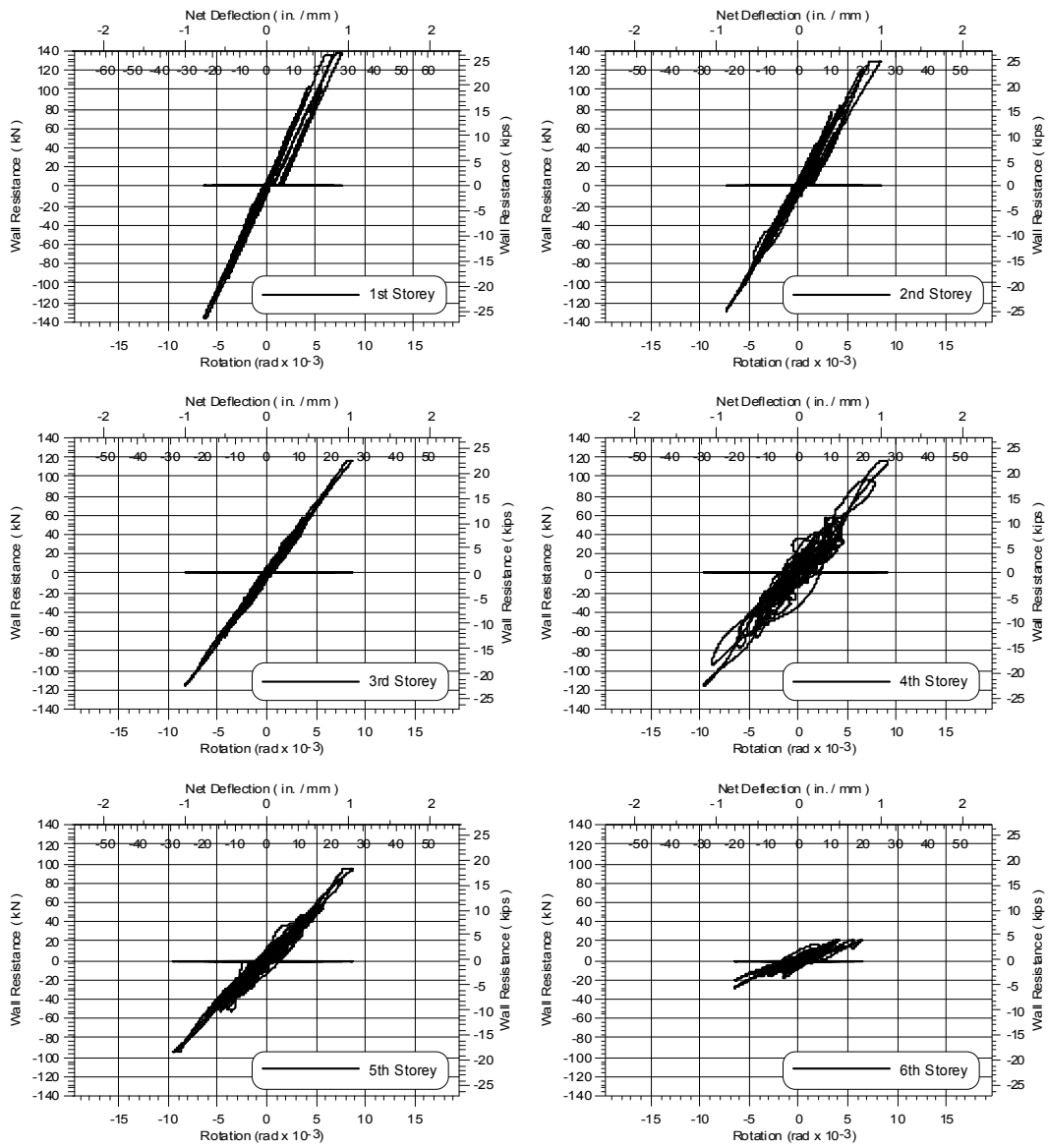

Figure H.1: Hystereses for each storey, CM earthquake record, model 6S RdRo2.6-minbrace sized 100% full brace/chord stud

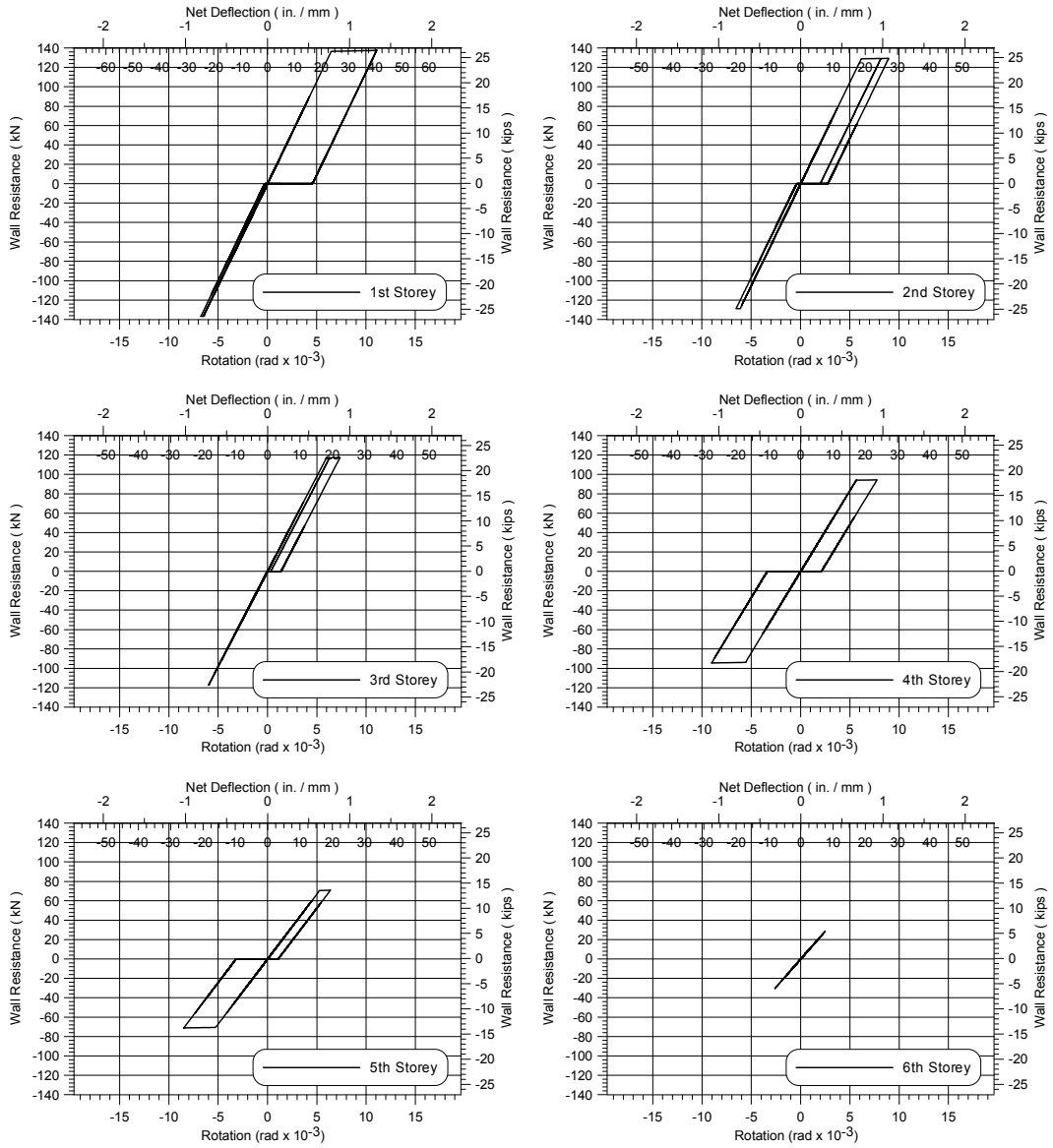

Figure H.2: Hystereses for each storey, CM earthquake record, model 6S $R_d R_o 2.6$ -minbrace

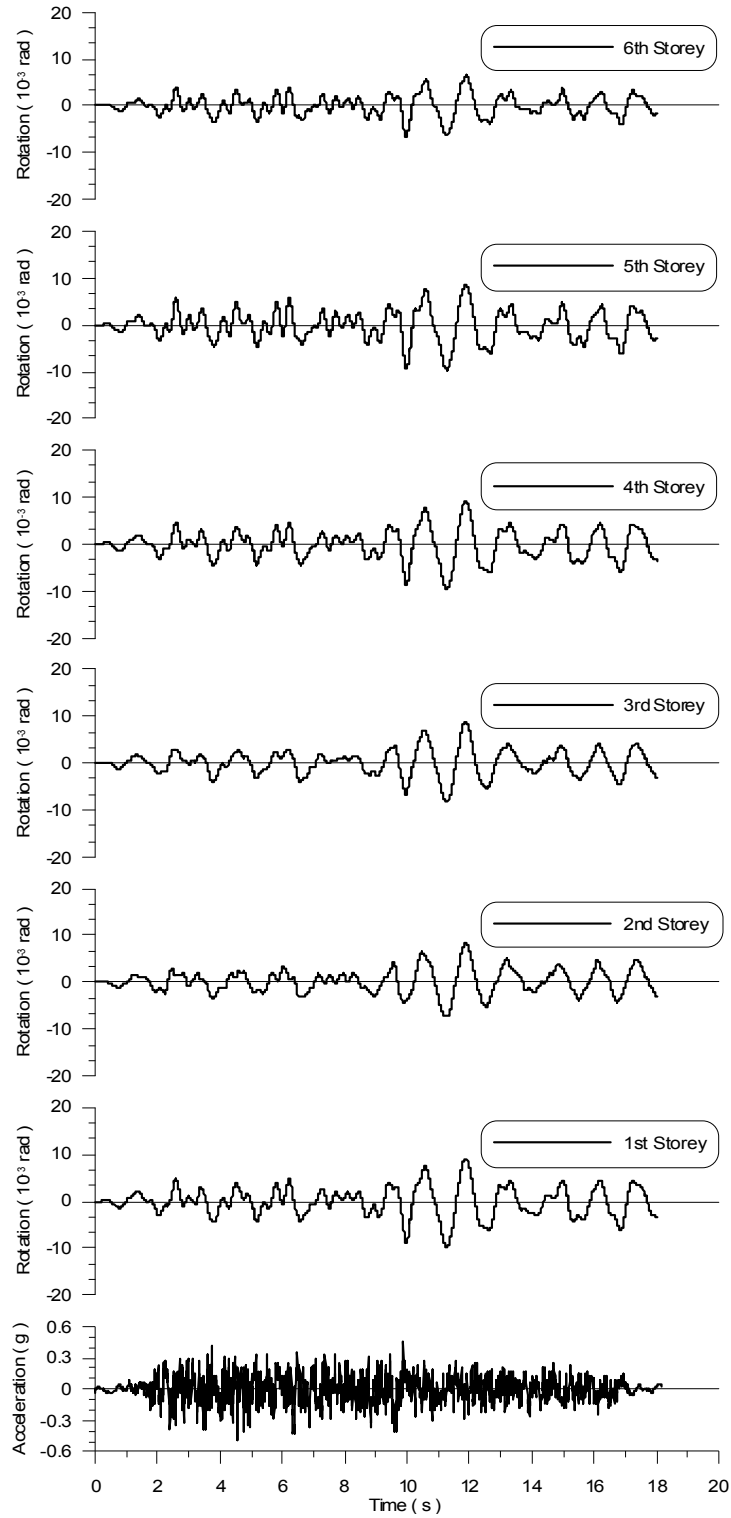

Figure H.3: Time history showing rotation vs. time for each storey, CM earthquake record, model 6S RdRo2.6-minbrace sized 100% full brace/chord stud

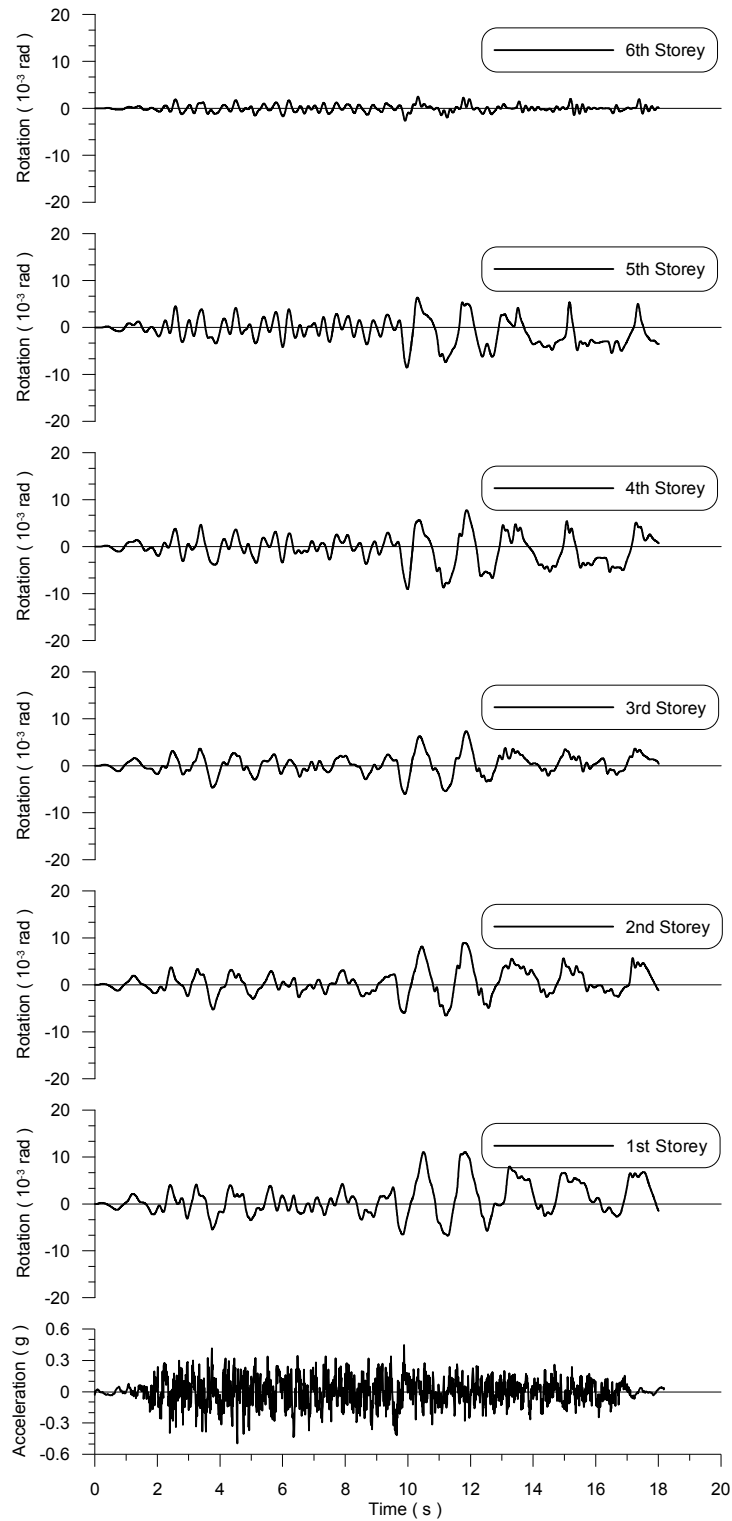

Figure H.4: Time history showing rotation vs. time for each storey, CM earthquake record, model 6S $R_d R_0$ 2.6-minbrace

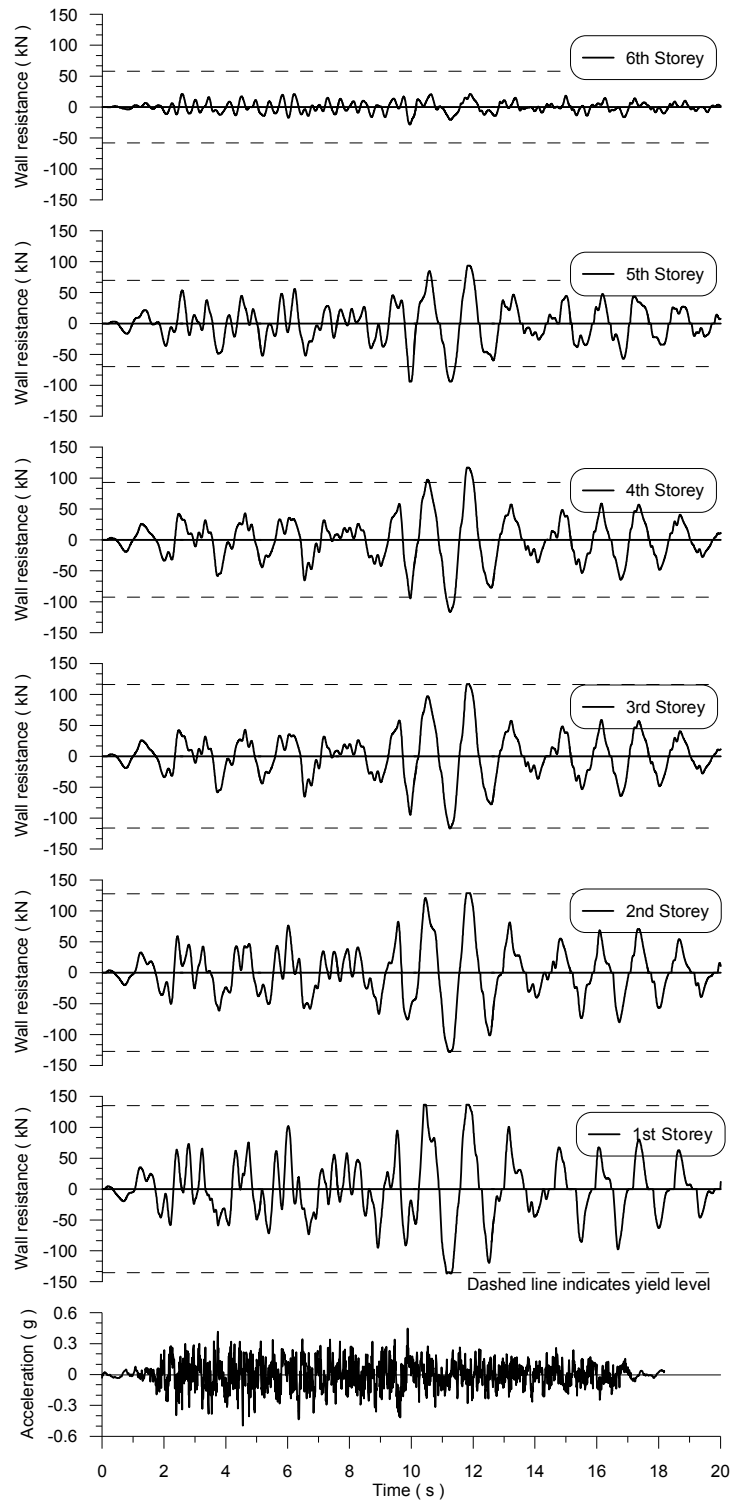

Figure H.5: Time history showing resistance vs. time for each storey, CM earthquake record, model 6S R_dR_o2.6-minbrace sized 100% full brace/chord stud

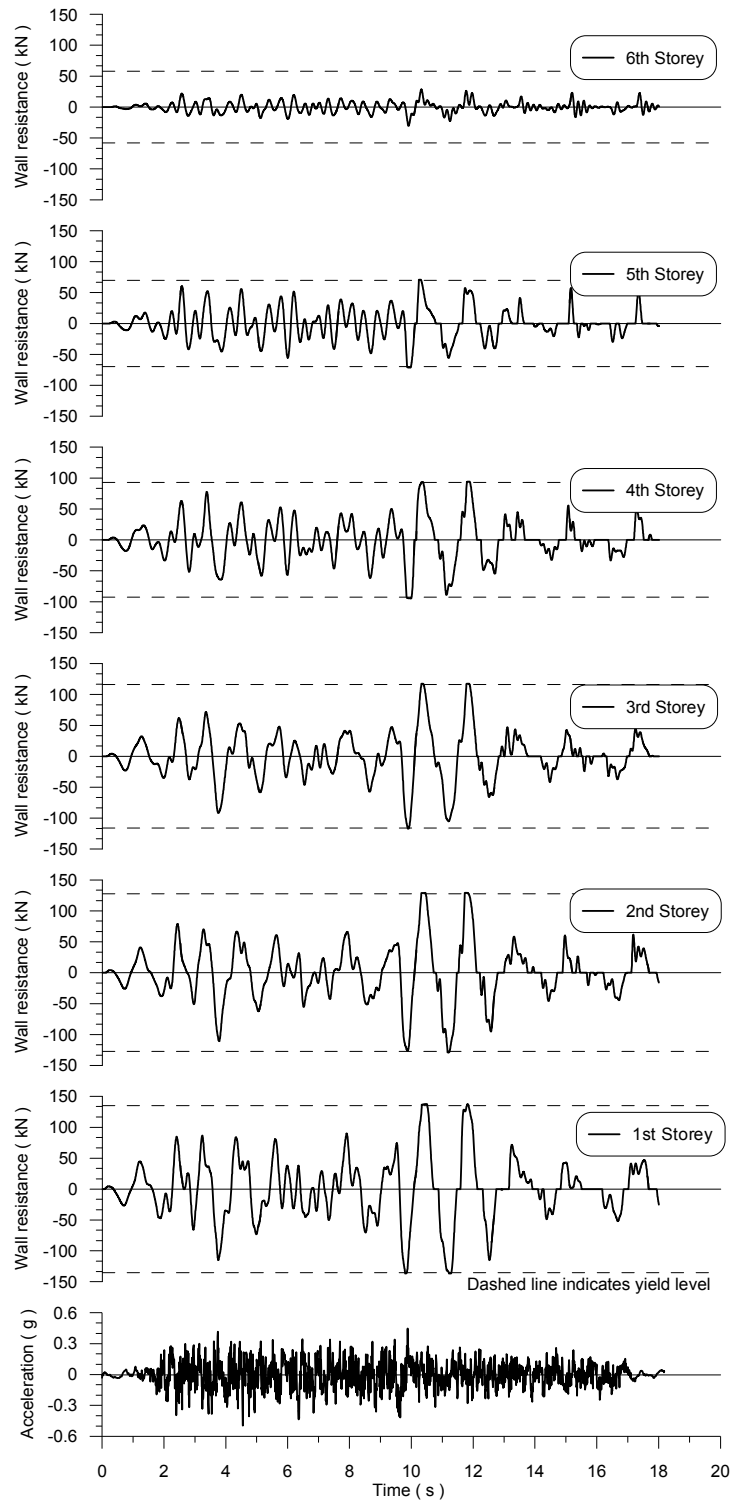

Figure H.6: Time history showing resistance vs. time for each storey, CM earthquake record, model 6S $R_d R_0$ 2.6-minbrace

Appendix I

Dynamic Analyses Results

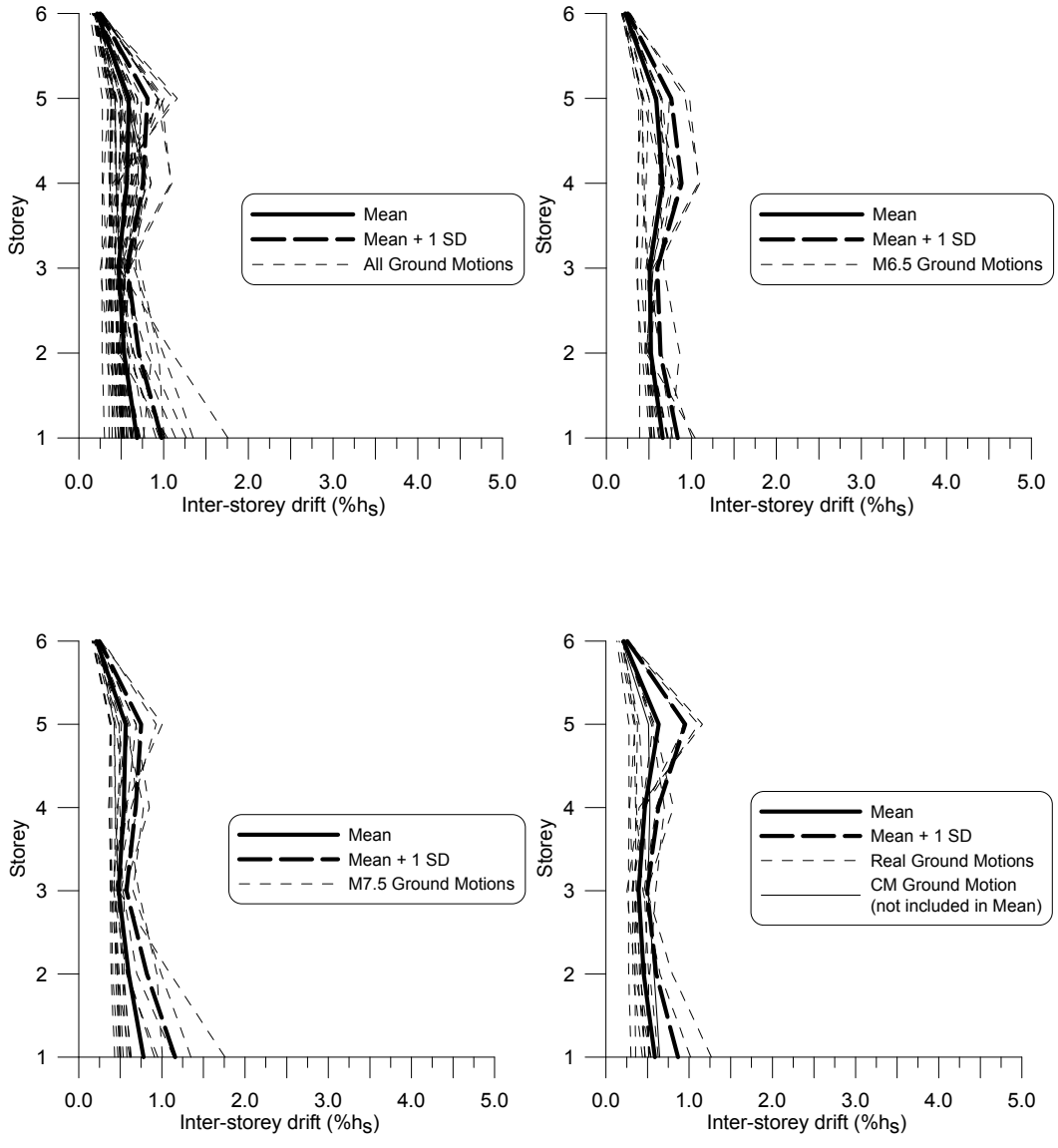

Figure I.2: Storey height versus inter-storey drift for 6S R_dR_o2.6-minbrace sized 100% full brace/chord stud model

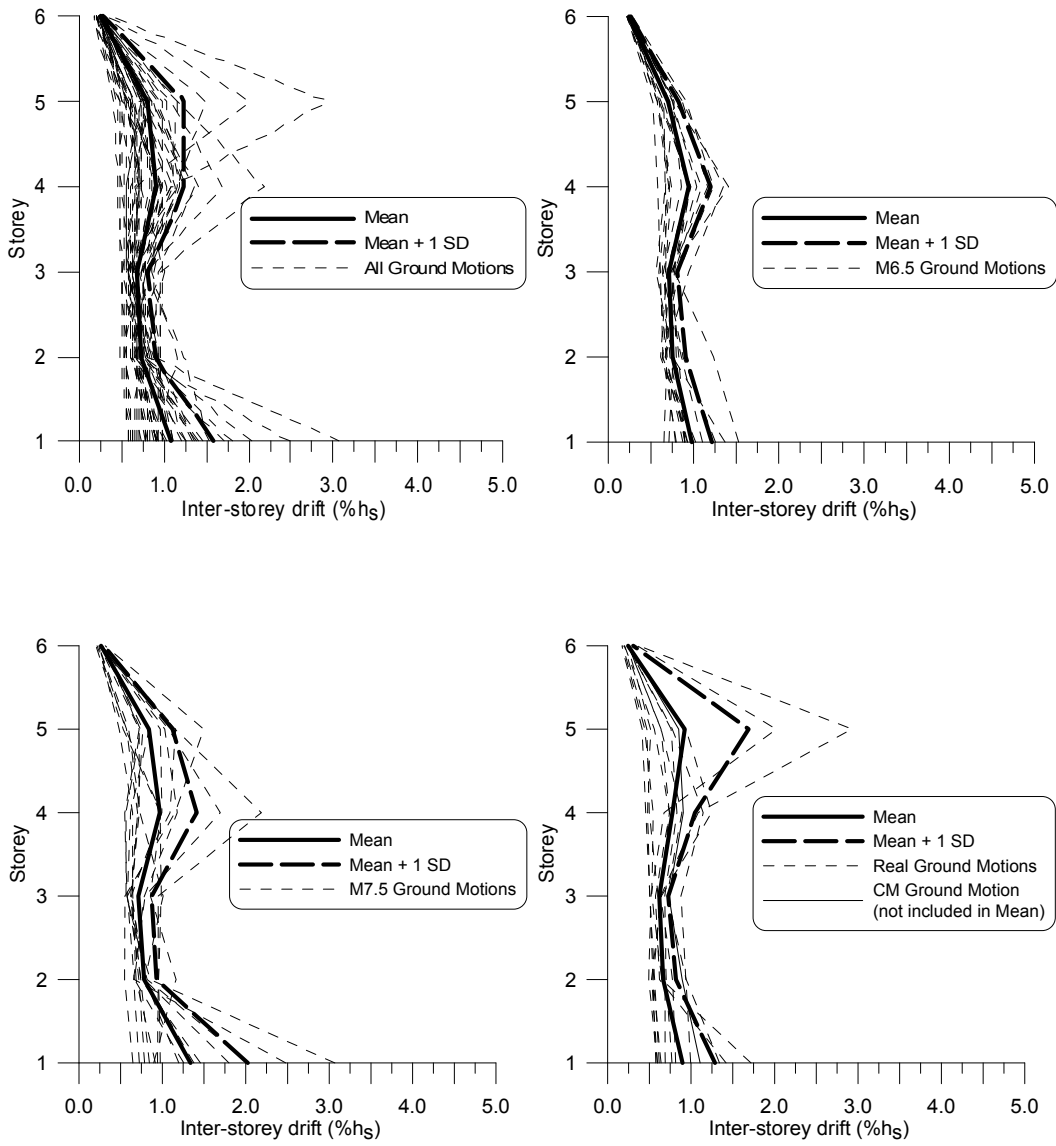

Figure I.3: Storey height versus inter-storey drift for 6S $R_d R_o 2.6$ -minbrace model

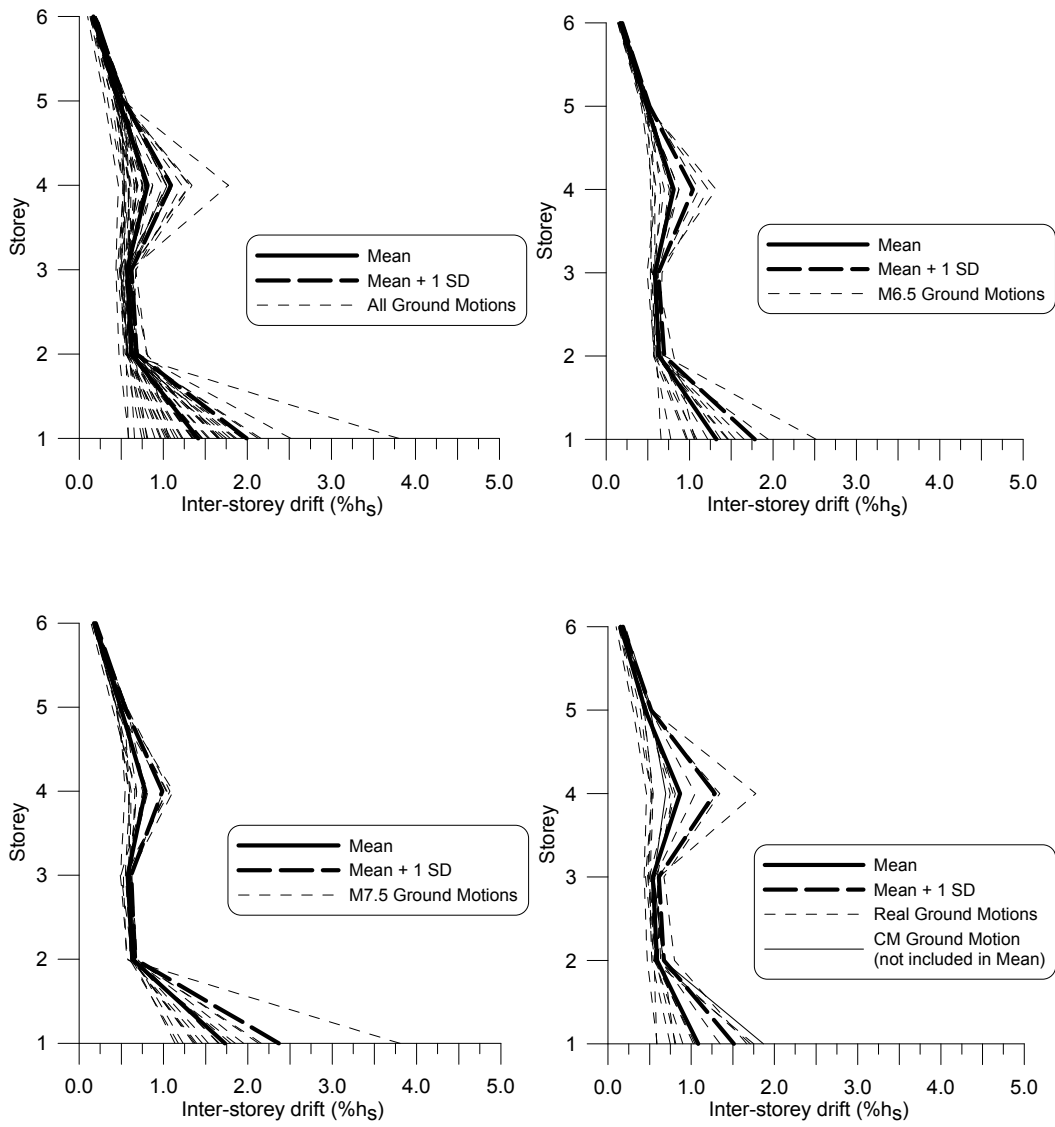

Figure I.4: Storey height versus inter-storey drift for 6S R_dR_o2.6-2brace model

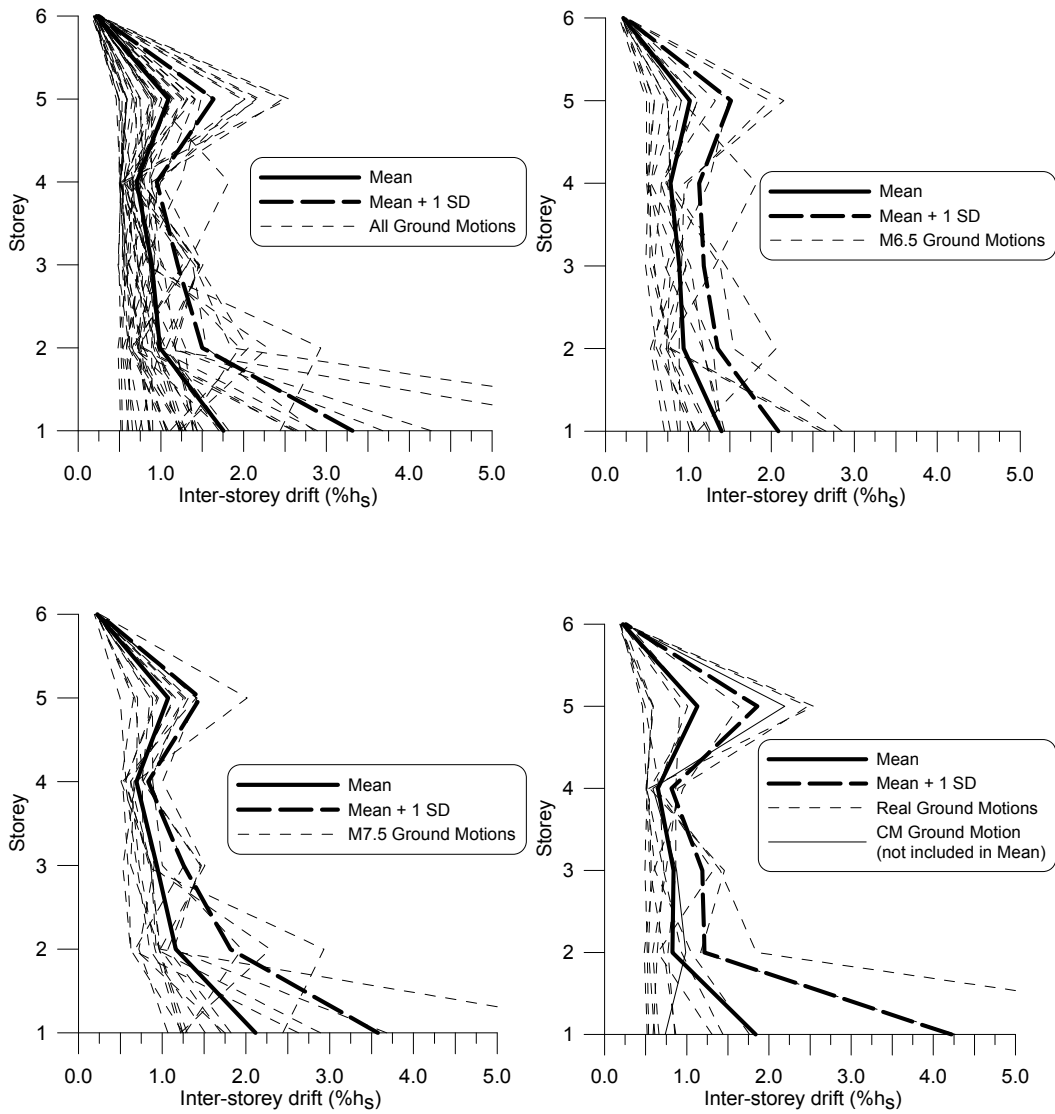

Figure I.5: Storey height versus inter-storey drift for 6S R_dR_o4-minbrace model

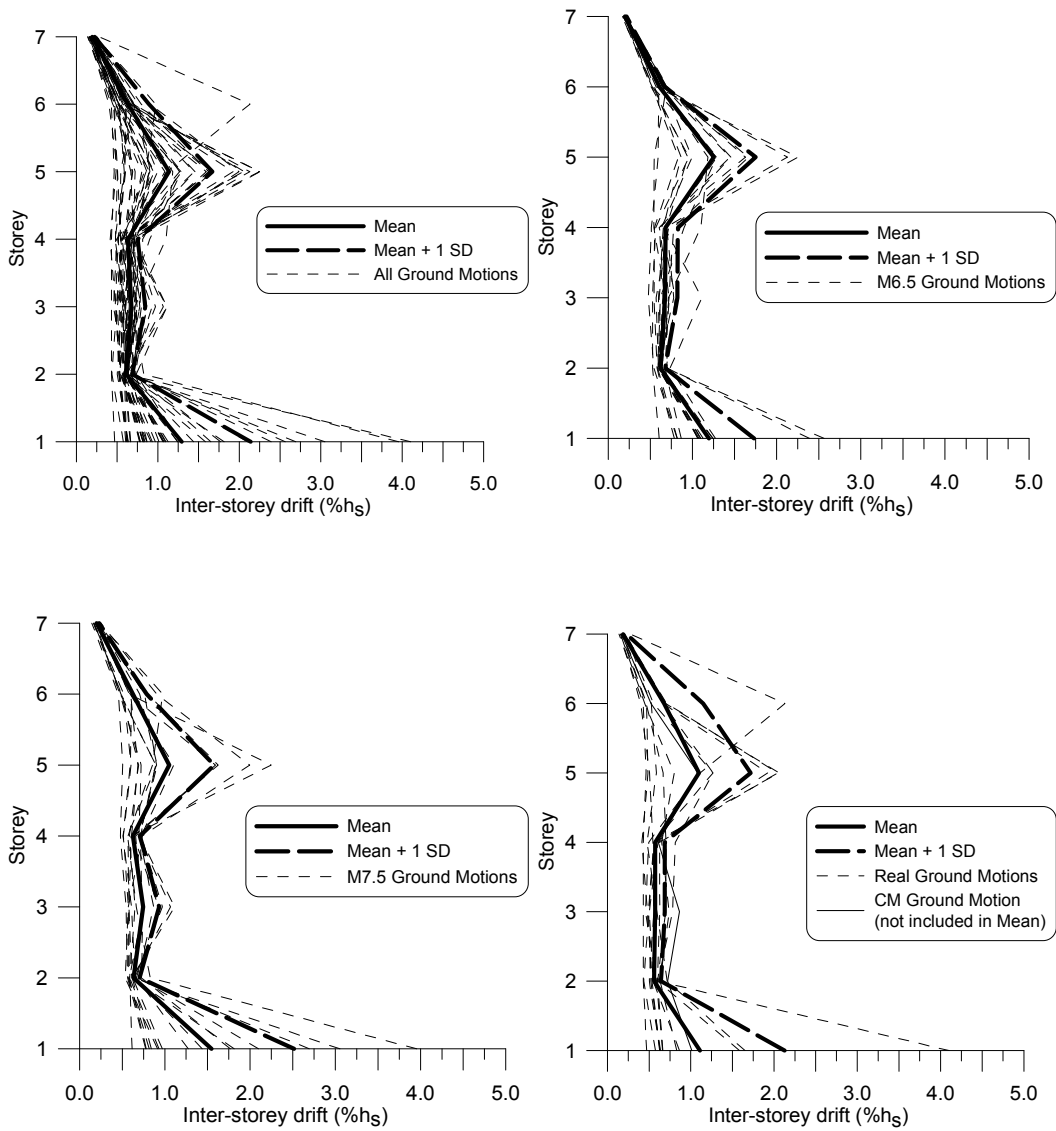

Figure I.6: Storey height versus inter-storey drift for 7S R_dR₀2.6-minbrace model

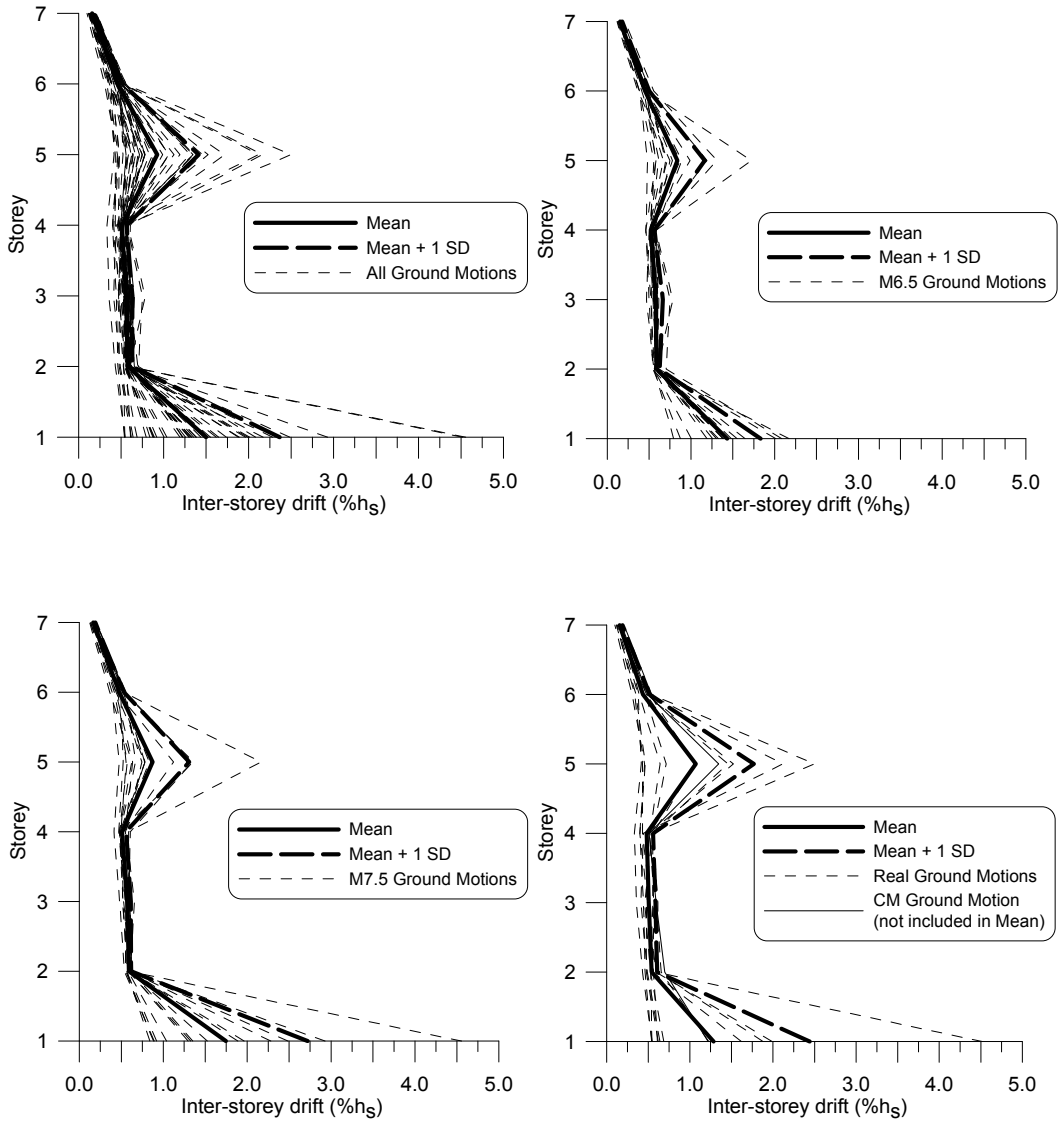

Figure I.7: Storey height versus inter-storey drift for 7S R_dR_{0.2.6}-2brace model

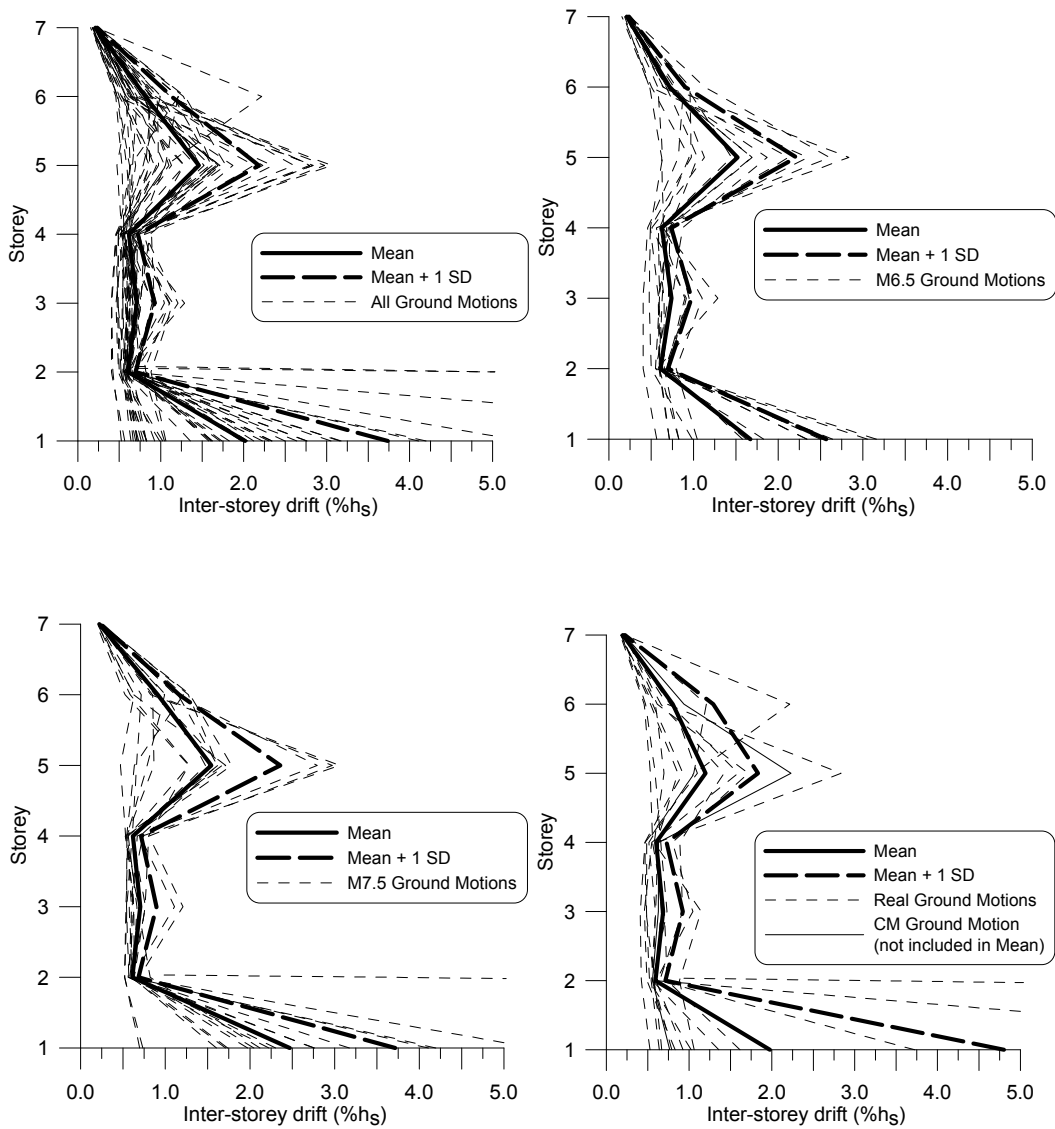

Figure I.8: Storey height versus inter-storey drift for 7S R_dR_o4-minbrace model

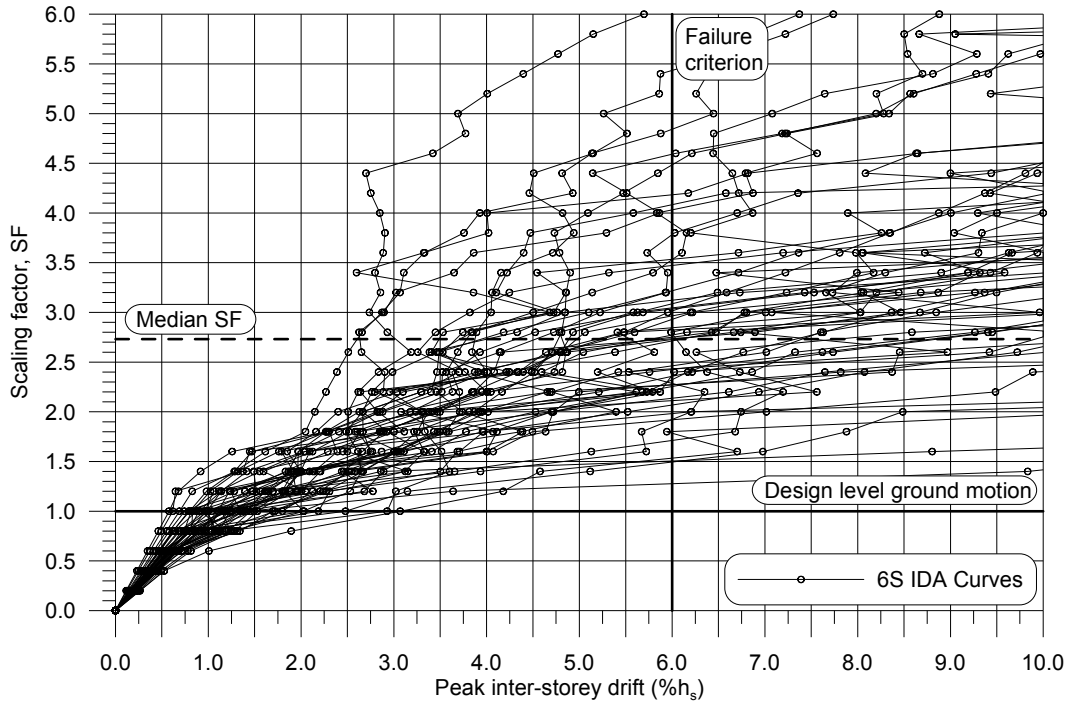

Figure I.9: IDA analysis for model 6S $R_d R_0 2.6$ -minbrace

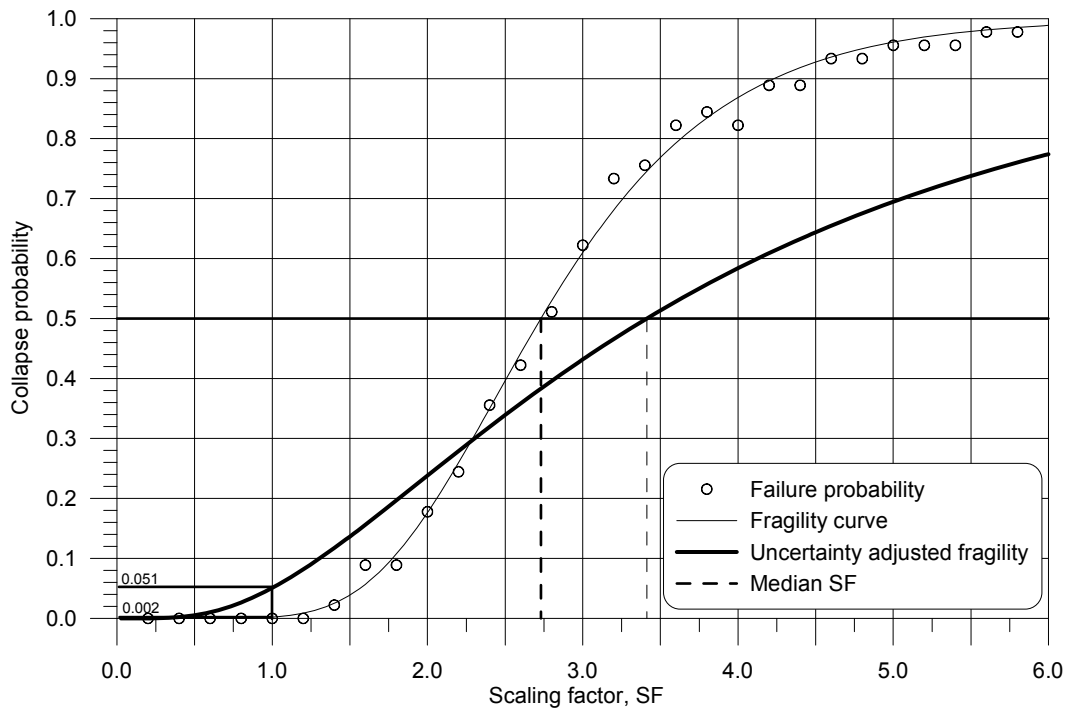

Figure I.10: Fragility curve for model 6S $R_d R_0 2.6$ -minbrace

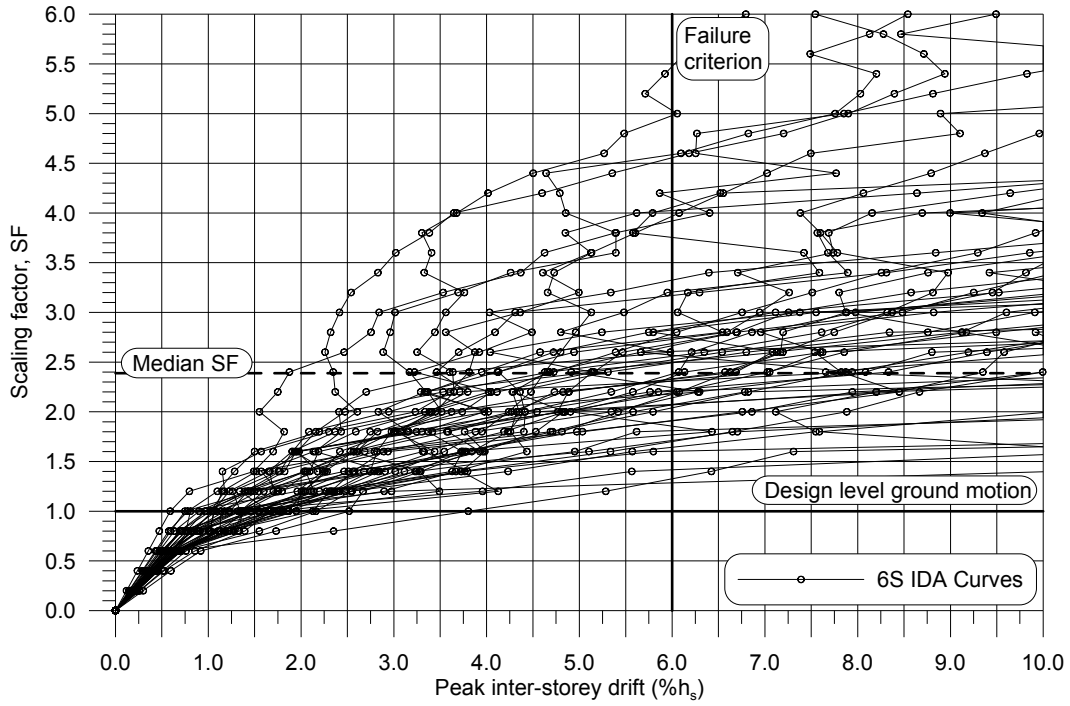

Figure I.11: IDA analysis for model 6S $R_d R_o 2.6-2$ brace

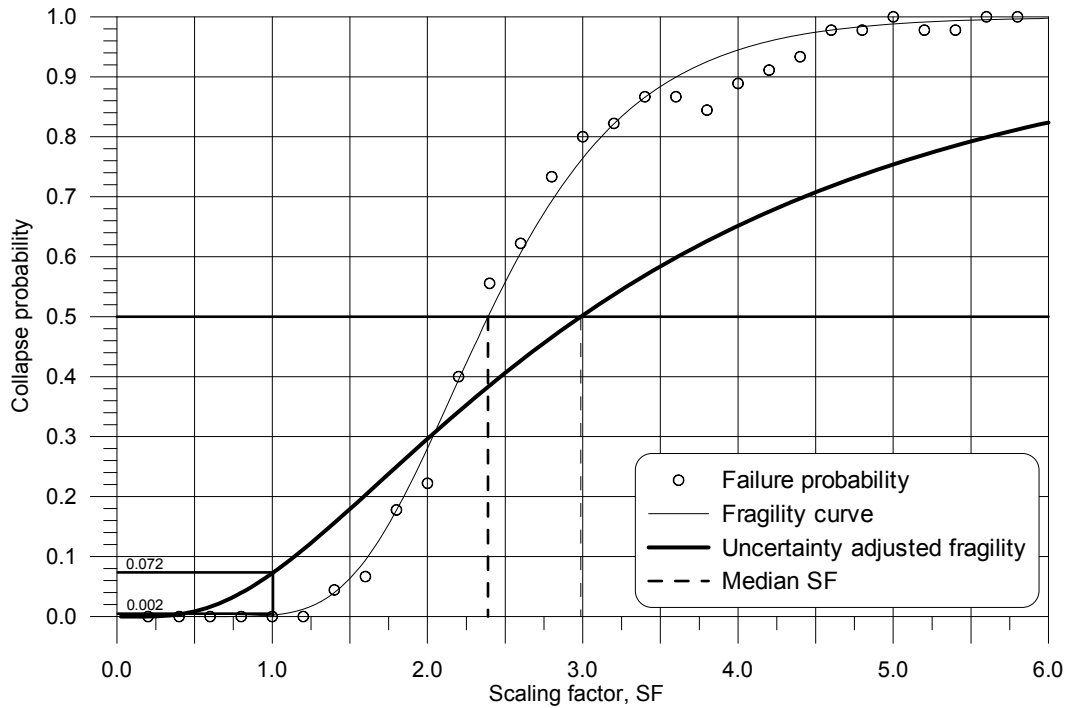

Figure I.12: Fragility curve for model 6S $R_d R_o 2.6-2$ brace

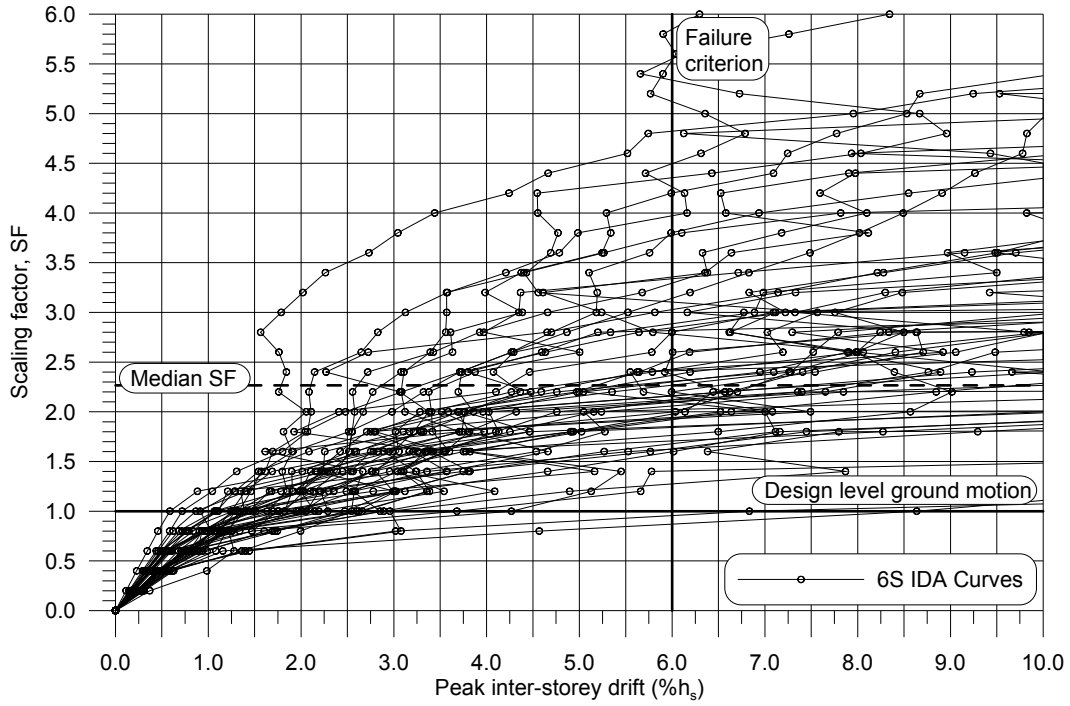

Figure I.13: IDA analysis for model 6S R_dR_o4-minbrace

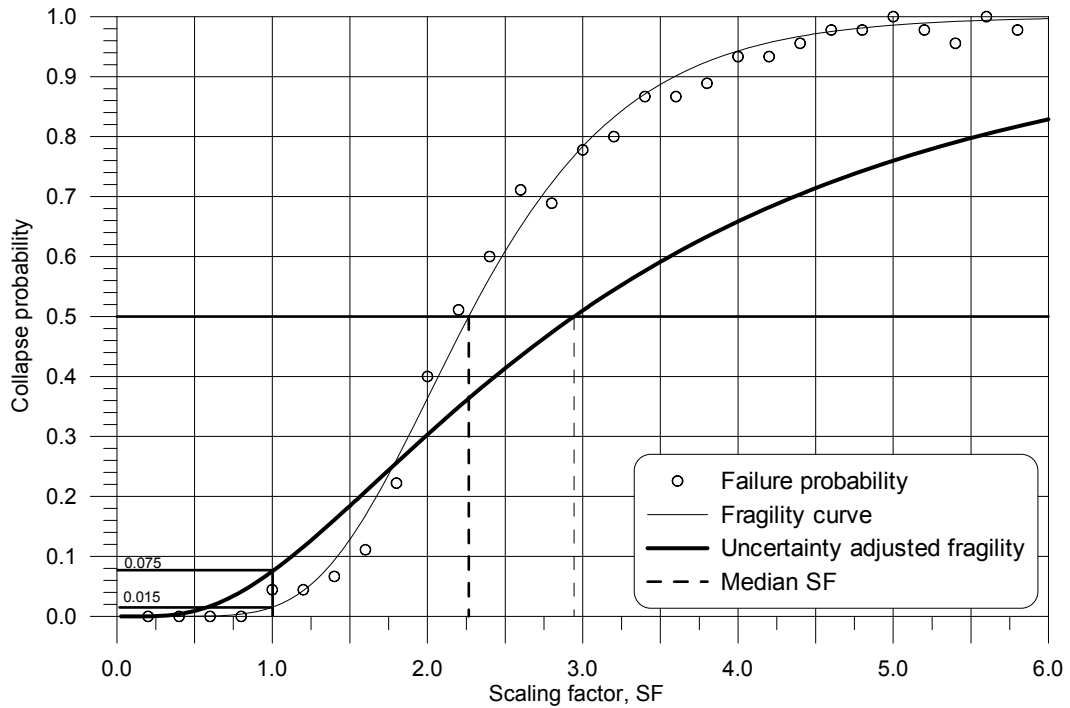

Figure I.14: Fragility curve for model 6S R_dR_o4-minbrace

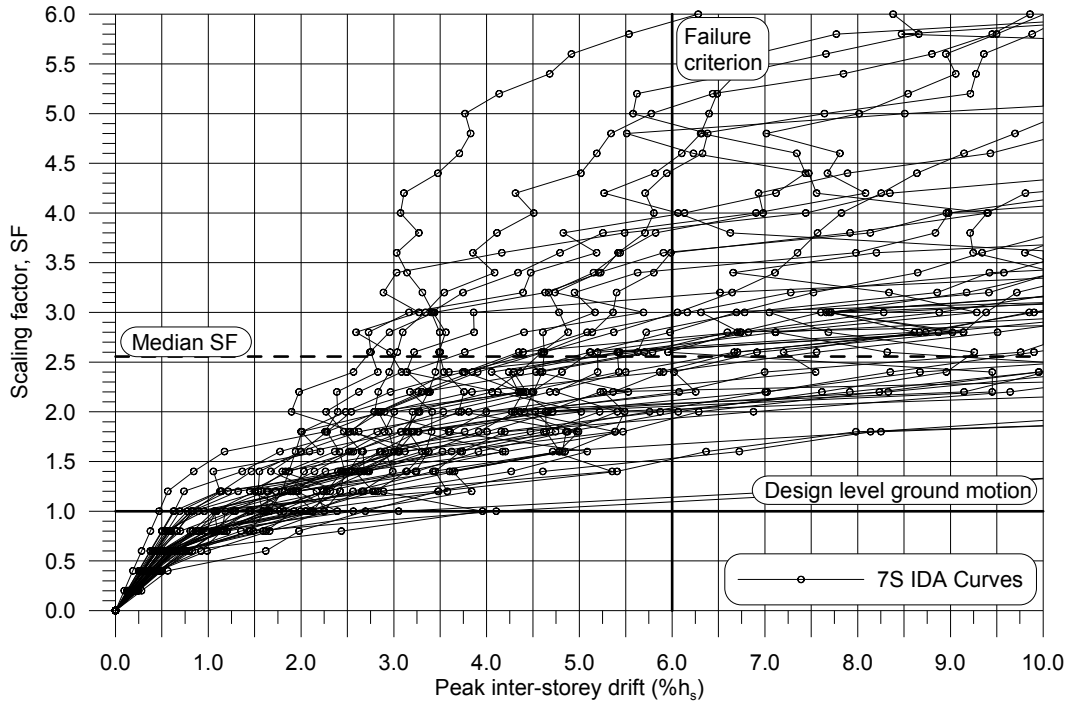

Figure I.15: IDA analysis for model 7S $R_d R_0 2.6$ -minbrace

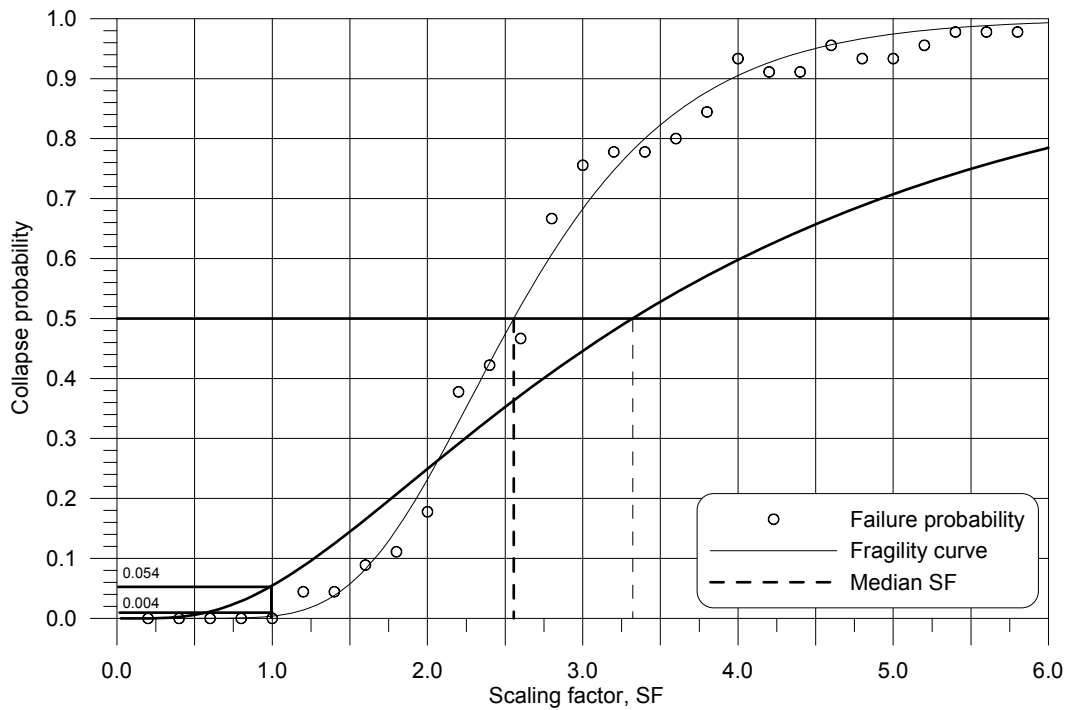

Figure I.16: Fragility curve for model 7S $R_d R_0 2.6$ -minbrace

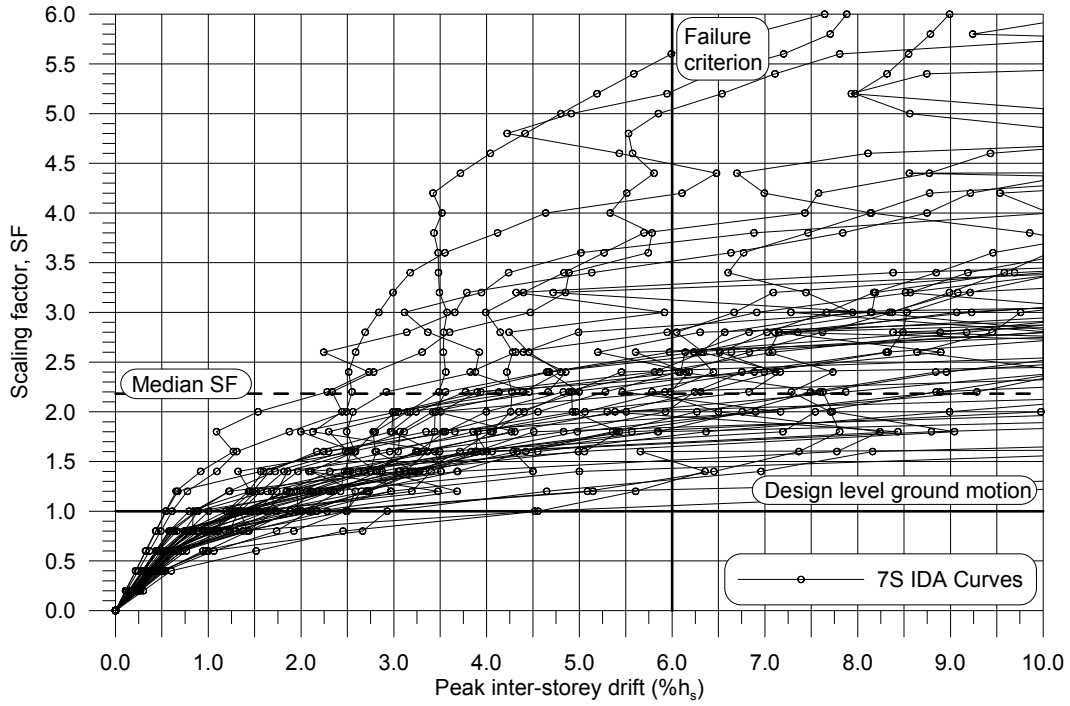

Figure I.17: IDA analysis for model 7S $R_d R_0 2.6-2brace$

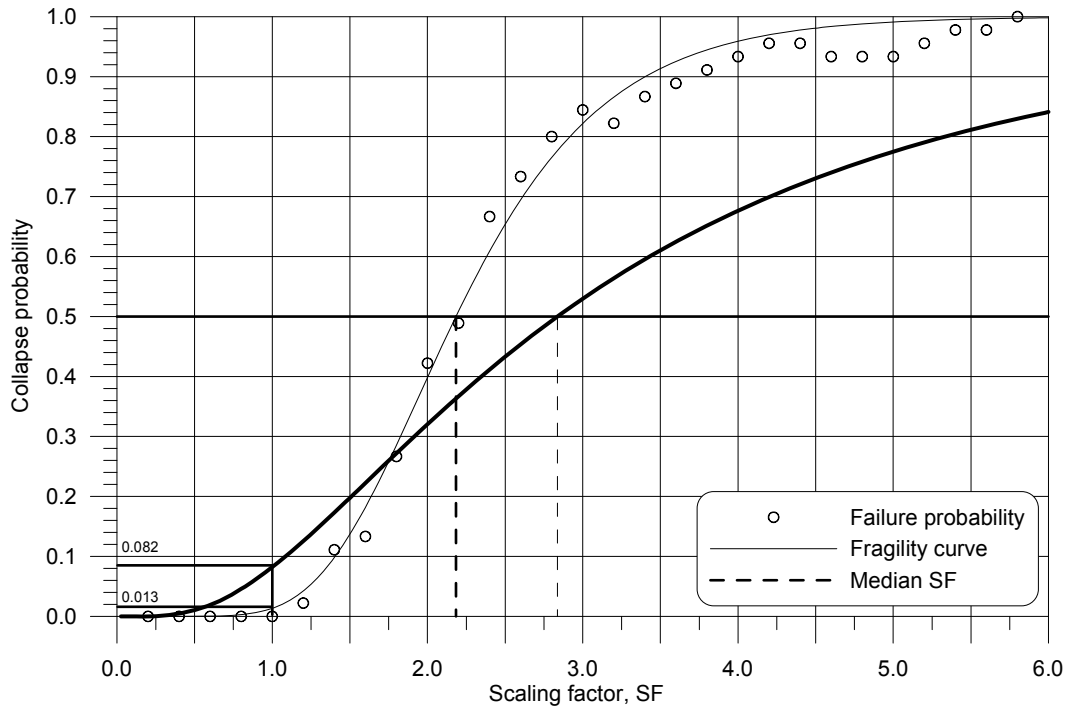

Figure I.18: Fragility curve for model 7S $R_d R_0 2.6-2brace$

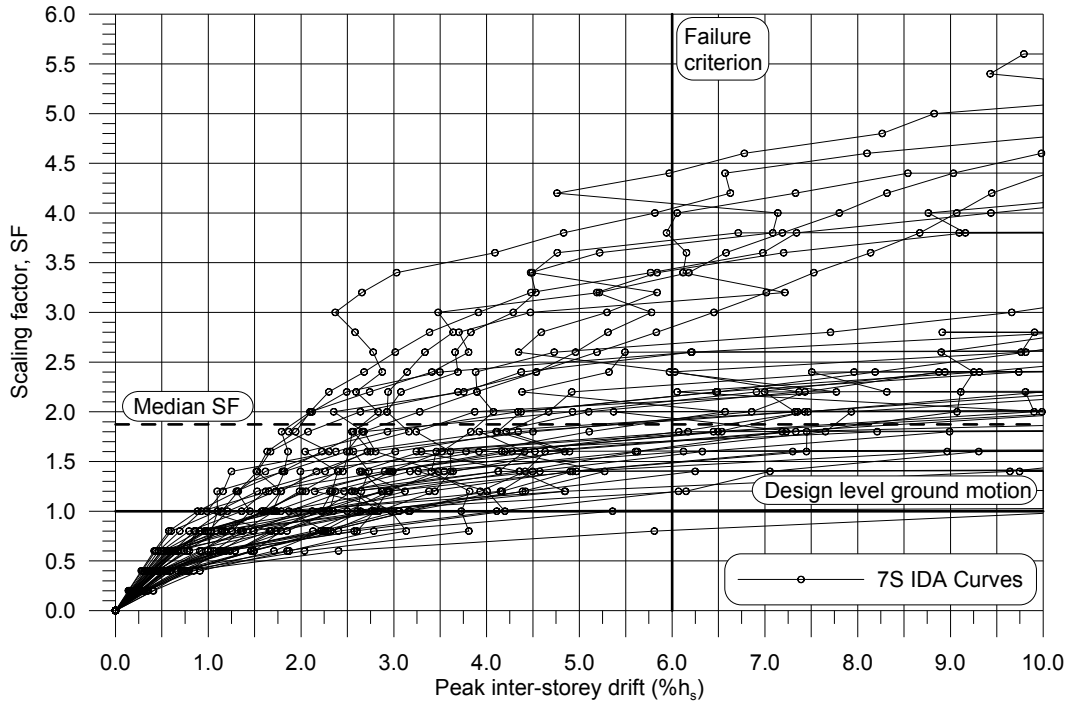

Figure I.19: IDA analysis for model 7S R_dR_o4 -minbrace

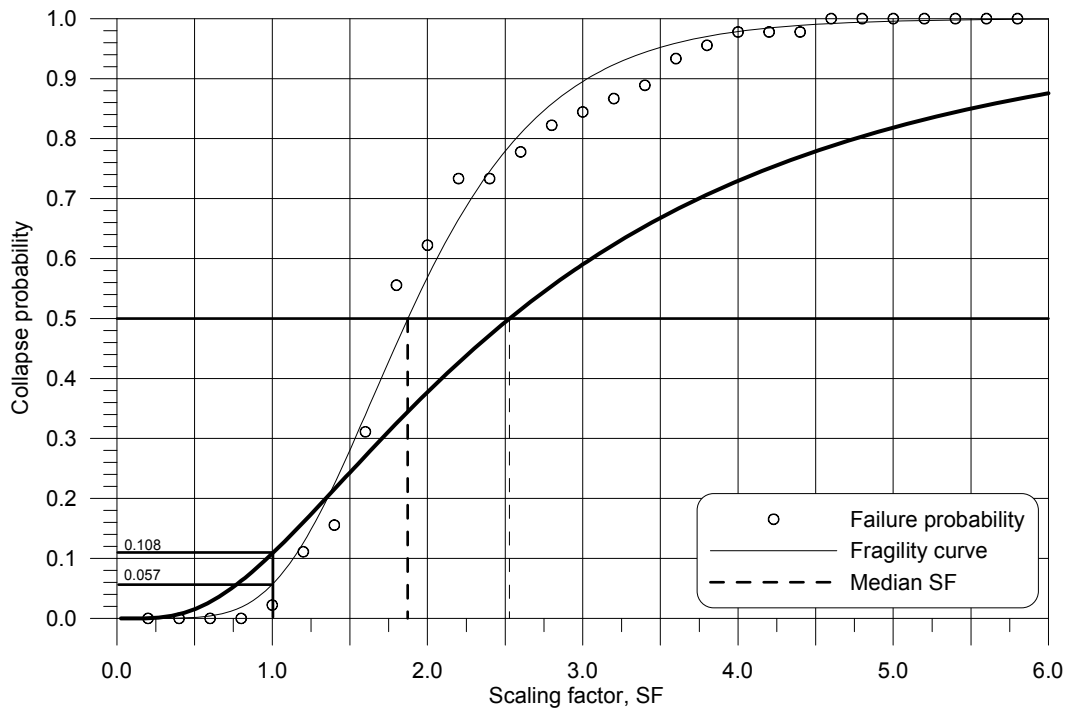

Figure I.20: Fragility curve for model 7S R_dR_o4 -minbrace

Appendix J

Tables with US Customary Units

Table 2.1: Probable forces in SFRS due to brace yielding

Force	Test Specimens ^a						
	Light		Medium		Heavy		
	8'×8' (1:1)	4'×8' (1:2)	8'×8' (1:1)	2'×8' (1:4)	8'×8' (1:1)	4'×8' (1:2)	2'×8' (1:4)
	13A-M 14A-C 15A-M 16A-C	15B-M 16B-C	17A-M 18A-C 19A-M 20A-C	19B-M 20B-C	21A-M 22A-C 23A-M 24A-C	23B-M 24B-C	23C-M 23C-C
$A_g R_y F_y$ Single Brace (kips)	5.37	5.37	8.05	8.05	14.77	14.77	14.77
Total Horizontal Force (kips) ^b	7.60	4.81	11.38	3.91	20.91	13.22	7.17
Total Vertical Force (kips) ^a	7.60	9.62	11.38	15.62	20.91	26.42	28.66

^aAspect ratio given in brackets

^bTotal force based on probable capacity of two tension braces

Table 2.2: Nominal axial compression capacity of back-to-back chord studs

Calculation assumptions	Test specimens						
	Light		Medium		Heavy		
	1:1	2:1	1:1	4:1	1:1	2:1	4:1
	13A-M 14A-C 15A-M 16A-C	15B-M 16B-C	17A-M 18A-C 19A-M 20A-C	19B-M 20B-C	21A-M 22A-C 23A-M 24A-C	23B-M 24B-C	23C-M 23C-C
Full composite action & web holes not considered (kips)	15.33		27.20		36.71		
Full composite action & 1.42 in web holes considered (kips)	13.40		23.74		31.47		
Web connections at 12 in o/c & web holes not considered (kips)	15.08		26.53		35.79		
Web connections at 12 in o/c & 1.42 in web holes considered (kips)	13.20		23.11		30.64		

Table 2.3: Nominal track compression, tension and bearing capacities

Calculation assumptions	Test specimens					
	Light		Medium		Heavy	
	13A-M 14A-C	15A-M 16A-C 15B-M 16B-C	17A-M 18A-C 19B-M 20B-C	19A-M 20A-C	21A-M 22A-C 23B-M 24B-C 23C-M 23C-C	23A-M 24A-C
Compression capacity, web holes not considered (kips)	4.90	9.10	9.31	14.16	14.16	25.09
Tension capacity - gross section yielding, web hole not considered (kips)	8.52	15.71	22.03	27.61	27.61	38.69
Tension capacity - net section fracture, 7/8in hole for shear anchor considered (kips)	9.78	17.72	26.08	32.66	32.66	45.68
^a Bearing Capacity at shear anchor hole, bolt hole deformation not considered (kips)	3.26	6.88	6.88	9.69	9.69	14.25
^a Bearing Capacity at shear anchor hole, bolt hole deformation considered (kips)	2.52	4.72	4.72	6.23	6.23	9.42

^aBearing capacity based on one shear anchor

Table 2.4: Strap weld design lengths and capacities

Calculation Assumptions ^a	Test Specimens						
	Light		Medium		Heavy		
	1:1	1:2	1:1	1:4	1:1	1:2	1:4
	13A-M 14A-C 15A-M 16A-C	15B-M 16B-C	17A-M 18A-C 19A-M 20A-C	19B-M 20B-C	21A-M 22A-C 23A-M 24A-C	23B-M 24B-C	23C-M 23C-C
Transverse Weld Length (in)	- ^b		2 3/4		4		
CSA S136	Longitudinal Weld Length, x 2 welds (in)	2.17	0.79		1.10		
	Total design fillet weld length (in)	6.81	4.33		6.22		
	Weld Group Capacity (kips)	5.40	8.18		14.77		
CSA S136 (40mm minimum weld length)	Longitudinal Weld Length, x 2 welds (in)	-	1.57		1.57		
	Total design fillet weld length (in)	-	5.91		7.17		
	Weld Group Capacity (kips)	-	9.15		16.05		

^aWeld capacity calculations based on 1/8in fillet weld and an electrode strength $F_{xx} = 59.4$ ksi

^bNo transverse welds used on light walls (see Figure 2.11)

Table 2.5: Nominal gusset plate resistance based on Whitmore section calculation

Calculation assumptions ^a	Test specimens						
	Light		Medium		Heavy		
	1:1	1:2	1:1	1:4	1:1	1:2	1:4
	13A-M 14A-C 15A-M 16A-C	15B-M 16B-C	17A-M 18A-C 19A-M 20A-C	19B-M 20B-C	21A-M 22A-C 23A-M 24A-C	23B-M 24B-C	23C-M 23C-C
Gusset plate capacity based on Whitmore section calculation, gross section yielding (kips)	NA		12.2		18.7		
Gusset plate capacity based on Whitmore section calculation, net section fracture (kips)	NA		16.1		24.8		

^aValues based on 1.57 in longitudinal weld length

Table 2.6: Material properties of strap braces

Strap width, (in)	Cross-head rate (in/min)	Strain rate ($\times 10^3 s^{-1}$)	Nominal thickness, t_n (in)	Base metal thickness, t_{avg} (in)	Yield stress, F_y (ksi)	Ultimate stress, F_u (ksi)	F_u / F_y	% Elongation	F_y / F_{yn}
2 1/2	0.00394	0.021	0.043	0.044	296	366	1.24	32.5	1.29
	1.968	10.4	0.043	0.044	310	381	1.23	30.4	1.35
	3.937	20.8	0.043	0.044	314	377	1.20	31.8	1.36
2 3/4	0.00394	0.021	0.054	0.056	387	560	1.45	27.2	1.14
	1.968	10.4	0.054	0.056	406	571	1.41	26.7	1.19
	3.937	20.8	0.054	0.056	406	584	1.44	28.1	1.19
4	0.00394	0.021	0.068	0.070	353	505	1.43	32.4	1.04
	1.968	10.4	0.068	0.070	372	521	1.40	30.7	1.10
	3.937	20.8	0.068	0.070	373	521	1.40	31.6	1.10

Table 2.7 : Material properties of studs, tracks and gusset plates

Member	Cross-head rate ^a (in/min)	Strain rate ($\times 10^3 s^{-1}$)	Nominal thickness, t_n (in)	Base metal thickness, t_{avg} (in)	Yield stress, F_y (ksi)	Ultimate stress, F_u (ksi)	F_u / F_y	% Elongation	F_y / F_{yn}
0.043 Stud	0.00394	0.021	0.043	0.046	42.9	53.0	1.18	28.8	1.41
0.043Track	0.00394	0.021	0.043	0.044	44.9	55.2	1.24	32.5	1.29
0.054 Stud	0.00394	0.021	0.054	0.056	45.5	54.6	1.45	27.2	1.14
0.054 Track	0.00394	0.021	0.054	0.056	56.1	81.2	1.45	27.2	1.14
0.054 Gusset	0.00394	0.021	0.054	0.056	58.8	82.8	1.45	27.2	1.14
0.068 Stud	0.00394	0.021	0.068	0.071	58.8	84.6	1.45	27.9	1.02
0.068 Track	0.00394	0.021	0.068	0.070	51.2	73.2	1.43	32.7	1.04
0.068 Gusset	0.00394	0.021	0.068	0.070	53.9	75.5	1.43	32.7	1.04
0.097 Track	0.00394	0.021	0.097	0.100	54.1	75.5	1.38	33.8	0.99

^aCross-head rate was increased to 0.236 in/min after full yielding was achieved.

Table 2.8: Comparison of measured, predicted and nominal elastic stiffness and yield resistance for monotonic tests

Wall		Test	K_c (kips/in)	K_p (kips/in)	K_c/K_p	K_c/K_n	S_y (kips)	S_{yp} (kips)	S_y/S_{yp}	S_y/S_{yn}	S_y/S_{yc}	
1 : 1	Light	13A-M	1	16.4	19.6	0.83	0.85	7.41	6.67	1.11	1.48	0.99
			2	15.5	19.9	0.78	0.80	7.31	6.78	1.08	1.46	0.97
		15A-M	1	15.3	19.6	0.78	0.80	6.98	6.67	1.05	1.39	0.93
			2	12.4	19.6	0.64	0.65	7.37	6.65	1.11	1.47	0.98
	Medium	17A-M	1	19.1	27.4	0.70	0.72	12.51	12.21	1.02	1.19	1.08
			2	18.4	27.4	0.67	0.69	12.88	12.21	1.05	1.22	1.11
		19A-M	1	18.7	27.5	0.68	0.70	12.74	12.26	1.04	1.21	1.10
			2	19.5	27.5	0.71	0.73	12.18	12.26	0.99	1.16	1.05
	Heavy	21A-M	1	33.3	43.7	0.76	0.78	20.84	20.38	1.02	1.08	0.98
			2	30.7	43.9	0.70	0.72	20.69	20.51	1.01	1.08	0.98
		23A-M	1	31.1	44.0	0.71	0.73	20.92	20.61	1.02	1.09	0.99
			2	31.4	43.9	0.72	0.74	20.35	20.51	0.99	1.06	0.96
1 : 2	Light	15B-M	1	4.8	9.9	0.49	0.49	4.55	4.19	1.08	1.43	0.95
			2	5.1	9.9	0.51	0.52	4.31	4.22	1.02	1.36	0.91
	Heavy	23B-M	1	11.9	22.2	0.54	0.55	12.52	12.99	0.96	1.03	0.94
			2	9.5	22.2	0.43	0.44	12.90	12.97	0.99	1.06	0.96
1 : 4	Medium	19B-M	1	1.9	4.7	0.40	0.41	4.07	4.20	0.97	1.13	1.03
			2	1.8	4.7	0.37	0.39	4.16	4.20	0.99	1.15	1.05
	Heavy	23C-M	1	2.7	7.9	0.34	0.35	6.26	7.06	0.89	0.95	0.86
			2	2.9	7.9	0.36	0.37	6.29	7.03	0.90	0.95	0.87

Table 2.9: Comparison of measured, predicted and nominal elastic stiffness and yield resistance for cyclic tests

Wall		Test ^a	K _e (kips/in)	K _p (kips/in)	K _e /K _p	K _e /K _n	S _y (kips)	S _{yp} (kips)	S _y /S _{yp}	S _y /S _{yn}	S _y /S _{yc}	
1 : 1	Light	14A-C	-ve	16.0	19.6	0.81	0.83	8.23	7.09	1.16	1.64	1.09
			+ve	16.7	19.6	0.85	0.87	8.26	7.09	1.16	1.65	1.10
		16A-C	-ve	17.8	19.6	0.90	0.92	8.16	7.07	1.15	1.63	1.08
			+ve	15.5	19.6	0.79	0.80	8.05	7.07	1.14	1.60	1.07
	Medium	18A-C	-ve	19.8	27.4	0.72	0.74	13.95	12.85	1.08	1.33	1.21
			+ve	22.3	27.4	0.82	0.84	14.27	12.85	1.11	1.36	1.23
		20A-C	-ve	22.6	27.5	0.82	0.85	14.45	12.87	1.12	1.37	1.25
			+ve	20.5	27.5	0.75	0.77	14.58	12.87	1.13	1.39	1.26
	Heavy	22A-C	-ve	34.0	43.9	0.77	0.80	23.41	21.64	1.08	1.22	1.11
			+ve	35.5	43.9	0.81	0.83	24.44	21.64	1.13	1.27	1.15
		24A-C	-ve	32.5	43.8	0.74	0.76	23.24	21.58	1.08	1.21	1.10
			+ve	33.8	43.8	0.77	0.79	23.30	21.58	1.08	1.21	1.10
1 : 2	Light	16B-C	-ve	5.7	9.9	0.57	0.58	4.97	4.47	1.11	1.57	1.04
			+ve	5.1	9.9	0.51	0.52	5.00	4.47	1.12	1.57	1.05
	Heavy	24B-C	-ve	11.2	22.1	0.51	0.52	13.62	13.68	1.00	1.12	1.02
			+ve	11.8	22.1	0.53	0.55	13.93	13.68	1.02	1.14	1.04
1 : 4	Medium	20B-C	-ve	2.1	4.7	0.45	0.46	4.37	4.41	0.99	1.21	1.10
			+ve	2.1	4.7	0.43	0.45	4.32	4.41	0.98	1.20	1.09
	Heavy	24C-C	-ve	2.9	7.9	0.37	0.38	5.34	7.41	0.72	0.81	0.74
			+ve	2.5	7.9	0.31	0.32	5.04	7.41	0.68	0.76	0.69

^a '-ve' and '+ve' denote values from the negative and positive load and displacement side if the test hysteresis respectively.

Table 2.10: Other measured test properties for monotonic tests

Wall		Test	Ductility, μ (in/in)	Energy (ft-lb)	Lateral Δ_{max} (in)	Lateral drift (%)	R_d	R_o	
1 : 1	Light	13A-M	1	18.7	5364	8.46	8.8	6.03	1.72
			2	16.0	4729	7.60	7.9	5.57	1.71
		15A-M	1	19.0	5336	8.66	9.0	6.08	1.67
			2	13.7	5010	8.15	8.5	5.15	1.68
	Medium	17A-M	1	11.8	9088	7.76	9.0	4.76	1.44
			2	10.2	8458	7.17	8.4	4.41	1.46
		19A-M	1	11.7	9206	8.50	8.9	4.73	1.46
			2	11.1	7356	6.93	7.2	4.60	1.44
	Heavy	21A-M	1	13.0	14874	8.19	8.5	4.99	1.31
			2	10.3	12545	7.80	8.1	4.43	1.28
		23A-M	1	11.3	13512	7.83	8.2	4.65	1.27
			2	12.2	13751	7.87	8.2	4.83	1.26
1 : 2	Light	15B-M	1	9.09	3204	8.58	9.0	4.14	1.65
			2	9.62	2897	8.19	8.6	4.27	1.58
	Heavy	23B-M	1	5.81	5904	6.14	6.4	3.26	1.18
			2	3.78	4777	5.24	5.4	2.56	1.19
1 : 4	Medium	19B-M	1	2.41	1349	5.20	5.4	1.95	1.25
			2	2.66	1631	6.18	6.4	2.08	1.28
	Heavy	23C-M	1	2.34	2278	6.02	6.3	1.92	1.05
			2	2.26	1971	5.04	5.2	1.88	1.06

Table 2.11: Other measured test properties for cyclic tests

Wall			Test ^a	Ductility, μ (in/in)	Energy (ft-lb)	Lateral Δ_{max} (in)	Lateral drift (%)	R_d	R_o
1 : 1	Light	14A-C	-ve	8.35	7300	4.29	4.5	3.96	1.82
			+ve	8.73		4.29	4.5	4.06	1.83
		16A-C	-ve	9.72	7101	4.45	4.6	4.29	1.81
			+ve	8.58		4.45	4.6	4.02	1.78
	Medium	18A-C	-ve	6.36	10753	4.49	4.7	3.42	1.47
			+ve	7.02		4.49	4.7	3.61	1.51
		20A-C	-ve	6.78	11053	4.33	4.5	3.54	1.53
			+ve	6.10		4.33	4.5	3.35	1.54
	Heavy	22A-C	-ve	6.44	18112	4.45	4.6	3.45	1.35
			+ve	7.08		4.88	5.1	3.63	1.41
		24A-C	-ve	6.28	17972	4.49	4.7	3.40	1.34
			+ve	6.52		4.49	4.7	3.47	1.35
1 : 2	Light	16B-C	-ve	5.06	4098	4.41	4.6	3.02	1.74
			+ve	4.50		4.45	4.6	2.83	1.75
	Heavy	24B-C	-ve	3.60	9559	4.37	4.5	2.49	1.24
			+ve	3.70		4.37	4.5	2.53	1.27
1 : 4	Medium	20B-C	-ve	2.34	3037	4.84	5.0	1.92	1.35
			+ve	1.94		4.06	4.2	1.70	1.33
	Heavy	24C-C	-ve	2.59	4790	4.72	4.9	2.04	0.90
			+ve	2.28		4.72	4.9	1.89	0.85

^a '-ve' and '+ve' denote values from the negative and positive load and displacement side if the test hysteresis respectively.

Table 3.1: Specified dead, live and snow loads

Dead loads		
Roof	Sheathing (3/4in plywood)	2.1 psf
	Insulation (4in blown fibre glass)	0.8 psf
	Ceiling (1/2in Gypsum)	2.1 psf
	Joists (cold-formed steel @24in o/c)	2.5 psf
	Sprinkler system	0.6 psf
	Roofing (3ply + gravel)	5.6 psf
	Mechanical	0.6 psf
	D	14.4 psf
Interior	Walls (interior and exterior)	15.0 psf
	Flooring (1in hardwood)	4.0 psf
	Concrete slab (Hambro® system)	37.0 psf
	Acoustic tile (1/2in)	0.8 psf
	Joists (cold-formed steel @24in o/c)	2.5 psf
	Mechanical	0.6 psf
	D	59.9 psf
Live loads		
Roof	Snow load (Equation 3-1)	
	S	34.3 psf
Interior	Residential area	39.7 psf
	L	39.7 psf

Table 3.2: Summary of design storey shear for building 6S R_dR_o2.6-minbrace

Storey	W _i (kips)	h _i (ft)	W _i x h _i	F _x (kips)	T _x (kips)	N _x (kips)	V _{ix} (kips)	ΣV _{ix} (kips)
6	54.3	62.0	3371	20.0	2.0	0.3	22.3	22.3
5	141.8	52.0	7377	28.2	2.8	0.9	32.0	54.3
4	141.8	42.0	5958	22.8	2.3	0.9	26.0	80.3
3	141.8	32.0	4539	17.4	1.7	0.9	20.1	100.4
2	141.8	22.0	3121	11.9	1.2	0.9	14.1	114.5
1	141.8	12.0	1702	6.5	0.7	0.9	8.1	122.6
Sum	763.2	-	26068	106.9	-	-	122.6	-

Table 3.3: Example of chosen strap sizes (6S R_dR_o2.6-minbrace)

Storey	T _{design} (kips)	F _y (ksi)	t (in)	Strap size, b (in)	Nominal strap size (in)
6	3.1	50	0.068	1.04	2.5
5	7.7	50	0.068	2.54	3.0
4	11.4	50	0.068	3.76	4.0
3	14.2	50	0.068	4.70	5.0
2	16.2	50	0.068	5.36	5.5
1	19.4	50	0.068	6.41	6.5

Table 3.4: Elastic inter-storey drift calculation (6S R_dR_o2.6-minbrace)

Storey	Δ _E (in)	Δ _{mx} (in)	Interstorey Drift (%)	W _i (kips)	θ _x
6	0.134	0.354	0.3	54.6	0.006
5	0.331	0.862	0.8	220.8	0.022
4	0.307	0.795	0.7	386.9	0.025
3	0.307	0.795	0.7	553.0	0.028
2	0.134	0.354	0.8	54.6	0.033

Table 3.5: Periods of vibration for stick models

Model Name	Height, h (ft)	NBCC T _a =0.025h _n (s)	NBCC 2T _a (s) (design period)	RUAUMOKO fundamental period, T (s)	RUAUMOKO 2 nd mode period (s)
2S R _d R _o 2.6-minbrace	22.0	0.17	0.34	0.540	0.255
4S R _d R _o 2.6-minbrace	42.0	0.32	0.64	0.747	0.280
6S R _d R _o 2.6-minbrace	62.0	0.47	0.95	1.089	0.401
				1.040	0.371
				1.286	0.466
7S R _d R _o 2.6-minbrace	72.2	0.55	1.1	1.219	0.449
				1.163	0.419
				1.456	0.538

Table 3.6: Summary of ground motions for Vancouver, site class C

No. ^{a,b}	Event	Magn.	Station	deg.	PGA (g)	Epicentral Distance (mile)	Scaling factor, SF	Time step (s)
1	Simulated V7	6.5	-	-	0.19	16.9	3	0.005
2	Simulated V17		-	-	0.06	31.1	4	0.005
3	Simulated V25		-	-	0.13	16.9	3	0.005
4	Simulated V29		-	-	0.18	4.4	1.8	0.005
5	Simulated V30		-	-	0.20	6.6	1.8	0.005
6	Simulated V82		-	-	0.34	3.1	1.1	0.005
7	Simulated V100		-	-	0.41	2.2	1.3	0.005
8	Simulated V109		-	-	0.47	2.2	0.9	0.005
9	Simulated V148		-	-	0.29	3.4	1.1	0.005
10	Simulated V156		-	-	0.35	9.3	1	0.005
11	Simulated V161		-	-	0.38	31.1	0.7	0.005
12	Simulated V170		-	-	0.15	22.1	2	0.005
13	Simulated V179		-	-	0.17	25.6	2	0.005
14	Simulated V186		-	-	0.24	13.9	1.5	0.005
15	Simulated V188		-	-	0.17	25.5	1.8	0.005
16	Simulated V197		-	-	0.23	25.4	1.2	0.005
17	Simulated V237	7.5	-	-	0.78	0.6	0.5	0.005
18	Simulated V268		-	-	0.26	17.5	1.3	0.005
19	Simulated V305		-	-	0.28	31.1	1.3	0.005
20	Simulated V311		-	-	0.92	0.6	0.6	0.005
21	Simulated V317		-	-	1.53	4.4	0.6	0.005
22	Simulated V321		-	-	0.39	13.2	1.25	0.005
23	Simulated V326		-	-	2.62	4.4	0.25	0.005
24	Simulated V328		-	-	0.52	8.8	0.8	0.005
25	Simulated V344		-	-	1.04	6.0	0.5	0.005
26	Simulated V355		-	-	1.19	8.6	0.5	0.005
27	Simulated V363		-	-	1.32	0.6	0.4	0.005
28	Simulated V389		-	-	0.26	4.5	1.1	0.005
29	Simulated V408		-	-	0.64	5.1	0.6	0.005
30	Simulated V410		-	-	0.34	8.5	0.9	0.005
31	Simulated V411		-	-	0.36	10.3	0.9	0.005
32	Simulated V430		-	-	0.13	13.6	2.4	0.005
33	CHICHIE	7.6	TCU045	90	0.49	48.2	1.1	0.005
34	CHICHIN			0			1	
35	FRULI000	6.5	Tolmezzo	0	0.33	12.6	1.5	0.005
36	FRULI270			270			1	
37	HECTOR000	7.1	Hector	0	0.3	16.5	2	0.005
38	HECTOR090			90			1.4	
39	KOBE000	6.9	Nishi-Akashi	0	0.51	5.4	0.8	0.01
40	KOBE090			90			1	
41	KOCAELI000	7.5	Arcelik	0	0.18	33.4	3	0.005
42	KOCAELI090			90			2.8	
43	MANJILL	7.4	Abbar	-	0.51	25.1	0.9	0.02
44	MANJILT			-			0.75	
45	CM	-	-	-	-	-	-	0.01

^aRecords 1 to 32 are synthetic (simulated) ground motions from Atkinson (2008)

^bRecords 33 to 44 are ground motions from PEER NGA database (PEER, 2005) (ATC-63, 2008)

Table 3. 7: Periods of vibration for full brace/chord stud models

Model Name		Height, h (ft)	NBCC $T_a=0.025h_n$ (s)	NBCC $2T_a$ (s) (design period)	RUAUMOKO fundamental period, T (s)	RUAUMOKO 2 nd mode period (s)
6S	R _d R _o 2.6-minbrace full brace/chord stud model, rigid chords, 80%K	62.0	0.47	0.95	0.78	0.287
	R _d R _o 2.6-minbrace full brace/chord stud model, sized chords, 80%K				1.07	0.340
	R _d R _o 2.6-minbrace full brace/chord stud model, sized chords, 100%K				1.01	0.312

Table 3.8: Inter-storey drift based on the seven earthquake records

Model Name		Height, h (ft)	R _d R _o Δ _E design ^a (%)	Δ _{max} RUAUMOKO and corresponding EQ record (%)		Δ _{average} RUAUMOKO (%)
2S	R _d R _o 2.6-minbrace	22.0	0.78	1.50	CM	1.16
4S	R _d R _o 2.6-minbrace	42.0	0.81	1.57	V305	1.12
6S	R _d R _o 2.6-minbrace	62.0	0.79	3.07	V305	1.40
7S	R _d R _o 2.6-minbrace	72.2	0.80	3.96	V305	1.63

^aR_dR_oΔ_E design based on strap brace stiffness only, R_d=2.0, R_o=1.3



American Iron and Steel Institute

1140 Connecticut Avenue, NW
Suite 705
Washington, DC 20036
www.steel.org



Steel Framing Alliance™

Steel. The Better Builder.

1201 15th Street, NW
Suite 320
Washington, DC 20005
www.steel framing.org

