

**Flexural Behavior and
Strength of Cold-Formed
Steel L-Headers**

RESEARCH REPORT RP08-3

2008



American Iron and Steel Institute



Steel Framing Alliance™

Steel. The Better Builder.

DISCLAIMER

The material contained herein has been developed by researchers based on their research findings and is for general information only. The information in it should not be used without first securing competent advice with respect to its suitability for any given application. The publication of the information is not intended as a representation or warranty on the part of the American Iron and Steel Institute, Steel Framing Alliance, or of any other person named herein, that the information is suitable for any general or particular use or of freedom from infringement of any patent or patents. Anyone making use of the information assumes all liability arising from such use.

PREFACE

The *North American Standard for Cold-Formed Steel Framing - Header Design*, AISI S212-07, provides design expressions for cold-formed steel L-headers. However, methods to evaluate deflection of single or double L-headers and uplift flexural strength of single L-headers are currently not addressed. Presented in this report are the findings from an extensive testing program conducted at the University of Waterloo of full-scale single and double cold-formed steel L-headers. Also presented are improved ultimate flexural strength design expressions and new vertical deflection expressions for single and double L-header assemblies.

It is anticipated that the AISI Committee on Framing Standards will consider the results of this study in the development of future standards and the Cold-Formed Steel Engineers Institute in the development of design aids. The American Iron and Steel Institute and Steel Framing Alliance wish to express their appreciation to the researchers and project sponsors for this report.

Flexural Behavior and Strength of Cold-formed Steel L-Headers

Prepared by
Jesse Pauls, B.ASc. (M.ASc. Candidate - University of Waterloo)

In conjunction with
Lei Xu, Ph.D., P.Eng. (Associate Professor, University of Waterloo)
and Steven Fox, Ph.D., P.Eng. (General Manager, CSSBI)

Prepared for
Canadian Sheet Steel Building Institute (CSSBI)

Waterloo, Ontario, Canada, 2008

Abstract

Cold-formed steel framing of residential and light commercial buildings continues to grow in popularity due to its structural and material advantages. The North American steel industry is actively performing research studies and developing design standards to assist in the cost-effectiveness of cold-formed steel in these markets. Cold-formed steel L-headers are structural components used over wall openings to transfer the loads to adjacent king studs. Recently, there has been an increased interest in L-headers among homebuilders primarily due to their ease of installation and low material cost. Design of the L-headers in North America is currently governed by the *North American Standard for Cold Formed Steel Framing – Header Design* (AISI, 2007) in combination with the *North American Specification for Design of Cold Formed Steel Structural Members* (CSA, 2007). However, the design provisions in the AISI - Header Design Standard (AISI, 2007) are particularly limiting. For instance, the method for evaluation of span deflections for both single and double L-headers, and uplift flexural strength for single L-headers is currently not available primarily due to lack of research on the issues.

Presented in this thesis are the findings from an extensive laboratory testing program of full-scale single and double cold-formed steel L-headers. The objective of the research was to investigate the structural behavior of L-headers under both gravity and uplift loads. From the analysis, improved ultimate flexural strength design expressions and new vertical deflection expressions for single and double L-header assemblies were developed.

Table of Contents

Abstract.....	ii
Table of Contents.....	iii
List of Figures.....	v
List of Tables.....	vii
List of Notations.....	viii
Chapter 1 Experimental Setup.....	1
1.1 General.....	1
1.2 Test Specimen.....	1
1.2.1 Material Properties.....	1
1.2.2 Section Properties.....	2
1.2.3 Test Specimen Assemblies.....	4
1.3 Short Span Test Setup.....	6
1.3.1 Gravity Tests.....	6
1.3.2 Uplift Tests.....	8
1.4 Long Span Test setup.....	9
1.4.1 Gravity Tests.....	10
1.4.2 Uplift Tests.....	11
1.4.3 Differences in Test Setup Compared to NAHB Research.....	11
Chapter 2 Results / Data analysis – Gravity Loads.....	13
2.1 General.....	13
2.2 Observed Failure Behavior.....	13
2.3 Flexural Strength – Ultimate Limit State.....	15
2.3.1 Double L-headers.....	17
2.3.2 Single L-headers.....	20
2.3.3 Single L-headers vs. Double L-headers.....	22
2.3.4 Comparison to Previous NAHB L-header Tests.....	22
2.4 Proposed Flexural Strength Design Equations.....	24
2.4.1 Comparison between Current and Proposed Flexural Strength Equations.....	28
2.5 Deflection – Serviceability Limit State.....	29
2.5.1 Short Span L-headers.....	29

2.5.2 Long Span L-headers	34
2.6 Proposed Deflection Prediction Equation	40
2.7 Effect of Gypsum Board on L-headers	43
Chapter 3 Results / Data Analysis – Uplift Loads.....	46
3.1 General.....	46
3.2 Observed Failure Behavior	46
3.3 Flexural Strength – Ultimate Limit State.....	50
3.3.1 Double L-headers	51
3.3.2 Single L-headers.....	53
3.3.3 Single L-headers vs. Double L-headers	54
3.4 Shear Influence on Strength.....	54
3.5 Proposed Flexural Strength Design Equation	56
3.6 Deflection – Serviceability Limit State.....	59
3.7 Proposed Deflection Prediction Equations	63
3.8 Effect of Gypsum Board on L-headers	67
Chapter 4 Conclusions.....	69
4.1 Recommendations for Future Research.....	71
Bibliography	72
Appendix A Assembly Properties	74
Appendix B Test Data	82

List of Figures

Figure 1.1 Double L-Header	4
Figure 1.2 Single L-Header.....	5
Figure 1.3 Gravity Load Case – Schematic 3ft and 4ft Test Setup.....	7
Figure 1.4 Gravity Load Case – Schematic 6ft Test Setup.....	7
Figure 1.5 Uplift Load Case – Schematic 3ft and 4ft Test Setup.....	8
Figure 1.6 Uplift Load Case – Schematic 6ft Test Setup.....	9
Figure 1.7 Long Span Load Cell Attachments.....	10
Figure 1.8 Gravity Load Case - Long Span Test Setup	11
Figure 1.9 Uplift Load Case - Long Span Test Setup.....	11
Figure 1.10 Comparison of Loading Configurations	12
Figure 2.1 Gravity Load Case - Failure of Short Span Assemblies	14
Figure 2.2 Gravity Load Case - Web Crippling under Applied Load.....	14
Figure 2.3 Gravity Load Case - Local Buckling of Compression Flange.....	15
Figure 2.4 Gravity Load Case - Long Span Flexural Failure at Mid-span.....	15
Figure 2.5 Gravity Load Case - M_{tg} Compared to M_{ng} for Double L-headers	27
Figure 2.6 Gravity Load Case - M_{tg} Compared to M_{ng} for Single L-headers.....	27
Figure 2.7 Gravity Load Case - Comparison between Current and Proposed Strengths ..	28
Figure 2.8 Gravity Load Case - Crushed Portion of L-header	30
Figure 2.9 Gravity Load Case - Typical Short Span L-header Load-Deflection Curve ...	31
Figure 2.10 Gravity Load Case - Typical Long Span L-header Load-Deflection Curve..	36
Figure 2.11 Semi-rigid Beam Member (Xu, 2001).....	36
Figure 2.12 Deflection vs. End-fixity Factor (Xu, 2001).....	37
Figure 2.13 Gravity Load Case - Typical Semi-Rigid Deflection Model.....	37
Figure 2.14 Semi-rigid Deflection Equations	38
Figure 2.15 Gravity Load Case - Comparison of Δ_{tg} to Δ_g for Double L-headers.....	43
Figure 2.16 Gravity Load Case - Comparison of Δ_{tg} to Δ_g for Single L-headers	43
Figure 2.17 Gravity Load Case - Drywall Comparison Load-Deflection Curve	45
Figure 3.1 Uplift Load Case - Buckling Failure of Web Section (6' Assemblies).....	47
Figure 3.2 Uplift Load Case - Flexural Buckling of Bottom Track.....	47
Figure 3.3 Uplift Load Case - Local Buckling of Web Section.....	48

Figure 3.4 Uplift Load Case - Prying of King Stud	48
Figure 3.5 Uplift Load Case - Screw failure at Ultimate Load.....	49
Figure 3.6 Uplift Load Case - Load-Deflection Curve Failure	50
Figure 3.7 Uplift Load Case - M_{tu} Compared to M_{nu} for Double L-headers.....	58
Figure 3.8 Uplift Load Case - M_{tu} Compared to M_{nu} for Single L-headers	58
Figure 3.9 Uplift Load Case - Typical Short Span Load-Deflection Curve	62
Figure 3.10 Uplift Load Case - Typical Long Span Load-Deflection Curve.....	62
Figure 3.11 Uplift Load Case - Comparison of Δ_{tu} to Δ_u for Double L-headers	65
Figure 3.12 Uplift Load Case - Comparison of Δ_{tu} to Δ_u for Single L-headers.....	66
Figure 3.13 Uplift Load Case - Drywall Comparison Load-Deflection Curve.....	68

List of Tables

Table 2.1 Long Span Ultimate Test Moment Equations	16
Table 2.2 Gravity Load Case - Double L-header Test Result Summary	18
Table 2.3 Gravity Load Case - Single L-header Test Result Summary	21
Table 2.4 Multi-point vs. Two-point Loading Configuration	23
Table 2.5 Gravity Load Case - Values of Ω and ϕ	26
Table 2.6 Gravity Load Case - Short Span L-Header Deflection Data Summary	32
Table 2.7 Gravity Load Case - Shear Deformation Contribution	33
Table 2.8 Gravity Load Case - Long Span Deflection Data Summary	34
Table 2.9 Semi-rigid Deflection m values	39
Table 2.10 Gravity Load Case - Long Span L-header Semi-Rigid Property Summary	40
Table 2.11 Gravity Load Case - Gypsum Board Test Results	44
Table 3.1 Uplift Load Case - Double L-header Test Result Summary	52
Table 3.2 Uplift Load Case - Single L-header Test Result Summary	53
Table 3.3 Uplift Load Case - Values of Ω and ϕ	59
Table 3.4 Uplift Load Case - Double L-header Deflection Summary	60
Table 3.5 Uplift Load Case - Single L-header Deflection Summary	61
Table 3.6 Uplift Load Case - Double L-header I_{eq}/I_{ec} Deflection Summary	63
Table 3.7 Uplift Load Case - Single L-header I_{eq}/I_{ec} Deflection Summary	64
Table 3.8 Uplift Load Case - Gypsum Board Test Results	67

List of Notations

A_w	Area of web ($t \times h$)
a	Distance between point loads
E	Modulus of Elasticity of steel
f	Stress level in compression element
F_y	Yield strength of L-section
F_v	Nominal shear stress
G	Shear Modulus of steel
h	Depth of L-section
I_{ec}	Effective moment of inertia, calculated at $f = F_y$ (causing compression in top flange)
I_{eq}	Equivalent effective moment of inertia
I_g	Gross moment of inertia
K_v	Shear buckling coefficient
L	Span length
M_{ng}	Nominal gravity flexural strength
M_{nu}	Nominal uplift flexural strength
M_{tg}	Ultimate test moment (gravity load case)
M_{tu}	Ultimate test moment (uplift load case)
P	Applied load at each cripple stud
P_t	Total applied load
R	End connection rotational stiffness AISI S212 Uplift factor
r	End-fixity factor
S_{ec}	Effective elastic section modulus, calculated at $f = F_y$ (causing compression in top flange)
t	Thickness of L-section
V_n	Nominal shear strength
V_{tu}	Maximum shear force from test (uplift load case)
Δ_g	Predicted mid-span deflection at service load level – gravity load case
Δ_{mid}	Mid-span deflection
Δ_u	Predicted mid-span deflection at service load level – uplift load case
Δ_{tg}	Tested mid-span deflection at service load level – gravity load case
Δ_{tu}	Tested mid-span deflection at service load level – uplift load case
ϕ	Load and Resistance Factor Design (LRFD) resistance factor
Ω	Allowable Stress Design (ASD) factor of safety

Chapter 1

EXPERIMENTAL SETUP

1.1 GENERAL

The experimental investigation was conducted in four main phases: short span gravity loaded tests, short span uplift tests, long span gravity loaded tests, and long span uplift tests. Each phase of testing was required to observe the flexural behavior and deflection performance of single and double L-header assemblies at various spans commonly used in residential and light commercial construction. Short span tests consisted of L-header assemblies with a clear span of 3ft (0.91m) to 6ft (1.83m). Long span tests consisted of spans ranging between 8ft (2.44m) to 16ft (4.88m). The testing procedure used for the short span tests was developed based on the test procedure implemented for similar tests, conducted at the NAHB Research Center. However, for the long span tests a different loading approach was implemented. The long span tests conducted at the NAHB Research Center were loaded using two-point loading, whereas the long span tests for this study were loaded with multiple loads at 24 inches (610mm) on center. Applying loads at 24 inches (610mm) on center is a closer simulation of the actual loading of such assemblies in typical residential load bearing wall construction. Simulating the actual loading conditions that are seen in the construction industry will help ensure the true behavior of L-headers assemblies is identified and will help create efficient design provisions.

All of the L-header assemblies were constructed with materials and methods appropriate for framing light commercial or residential cold-formed steel structures. Steel sections were provided by Bailey Metal Products Limited. Construction of the L-header assemblies and the testing was entirely performed at the University of Waterloo.

1.2 TEST SPECIMEN

1.2.1 Material Properties

All steel materials used conformed to minimum strength and thickness guidelines as per the *North American Specification for Cold-Formed Steel Structural Members* (CSA, 2007). Mechanical properties for the L-headers were based on tensile coupon tests and base steel

thickness measurements, conducted in accordance with ASTM A370 and ASTM A90 respectively (ASTM, 2003). Three coupons were cut from the web section of the L-shaped angle sections, by the University of Waterloo's machine shop, to meet the ASTM A370 requirements. Prior to testing, the galvanized coatings were removed by dipping the coupons in a sulfuric acid and water solution. Tensile tests were performed using an Instron 4206 testing machine, with a maximum capacity of 30 kips. Actual thickness and width measurements of the coupons were performed using a digital micrometer. Summarized in Tables A1 and A2 of Appendix A are the average mechanical properties for the material used in the gravity and uplift tests, respectively.

The material designation is as per the Steel Stud Manufacturers Association (SSMA). For example an 800L150-43 designation refers to an L-shaped angle with an 8" long leg (1/100 inches), 1.5" short leg (1/100 inches) and a 43 mil nominal thickness.

1.2.2 Section Properties

In reality, the performance and behavior of L-header assemblies are based on the entire assembly consisting of angle section(s), cripple studs, and track sections interconnected by self-drilling screws. Thus, determining the effective section properties for such complicated assemblies would be extremely difficult. As a simplification, the section properties for each L-header assembly were based entirely on the L-shaped angle(s), the top track or bottom track sections were not considered in the calculation of section properties. For strength determination the effective section modulus is required, while for deflection determination the effective moment of inertia is required.

Both the effective section modulus and effective moment of inertia of the L-shaped sections were calculated in accordance to the 2007 North American Specification (CSA, 2007). Currently, the North American Specification is published by different publishers depending on location. In the United States, the American Iron and Steel Institute (AISI S100) publishes the specification; however, in Canada the Canadian Standards Association (CSA S136) publishes the specification. For cold-formed steel L-headers, the effective section properties are dependent on the loading configuration. Under gravity loads, the top flange of the L-section experiences compression stresses, while the web section is subjected to a stress gradient with the compressive stress increasing towards the top flange. Under this

loading configuration the top flange acts as a stiffener to the web section under compression; as a result, the effective width of the web is increased.

In the case of uplift loads the top flange of the L-section experiences tensile stresses and the web section is subjected to a stress gradient. However, the compressive stress is now increasing towards the unstiffened free edge. With the compressed portion of the web being unstiffened, the effective width of the web is greatly reduced, resulting in a shift of the neutral axis towards the top flange and ultimately low effective section properties under uplift loads.

Recent changes to the *North American Specification for the Design of Cold-Formed Steel Structural Members* (CSA, 2007) have resulted in a significant decrease in section properties for L-headers under uplift loads. The new formulation; clause B3.2 2(ii) of the specification, for calculating the effective width of unstiffened compression elements subjected to stress gradients is however limited to elements with a web slenderness ratio, h/t of less than 60. In this study all of the tested headers had a web slenderness ratio exceeding this limit. It was found that if the slenderness ratio limit was ignored for the gravity load case, sections with a slenderness ratio of 150 or less resulted in identical section properties compared to the previously used method. However, for sections with web slenderness ratios larger than 150, the new formulation resulted in slightly larger section properties.

The calculated section properties based on a single L-section, for the gravity loaded tests are summarized in Table A3 of Appendix A. For double L-header assemblies, the values of the section properties were doubled. The subscript “c” denotes the section property was calculated based on gravity loading, producing compression in the top flange. A Visual Basic macro in Microsoft Excel was created in order to compute the following section properties; gross moment of inertia I_g , effective moment of inertia I_{ec} , and effective section modulus S_{ec} . All effective section properties were computed based on the maximum compression stress equaling the yield stress of the given material ($f = F_y$). Yielding of the tensile fiber was not considered a failure limit state. The inner radius of the L-shape corner was taken as twice the thickness. For the purposes of calculating the effective section properties the corner was assumed to be fully effective.

Under uplift loads the new formulation of the effective width of the web (clause B3.2 2(i) of the specification) resulted in a decrease in the section properties. As with the gravity load

case, the new formulation is limited to elements with a slenderness ratio (h/t) of less than 60. All of the L-sections used in the test program exceed this ratio, however if the new formulation is used for the uplift load cases, the resulting effective width of the web section is significantly reduced. With a small effective web section in compression, the neutral axis will shift towards the compression flange, resulting in small effective section properties. Since all the L-sections used within this test program greatly exceed the slenderness ratio of 60, a different approach was warranted. The gravity effective section modulus and gravity effective moment of inertia section properties were used for the uplift strength and deflection determination, respectively from herein. This is currently the approach also being used in the AISI S212-07 standard for the uplift strength determination (AISI, 2007).

Presented in Table A4 of Appendix A are the calculated section properties based on a single L-section, for the uplift loaded tests. The values are doubled for double L-headers.

1.2.3 Test Specimen Assemblies

The header assemblies were fabricated to simulate a typical opening in a 3-5/8 in. (92mm) wide steel stud wall assembly. One or two L-shaped cold-formed steel sections were added over the opening with the short leg lapping over the top track section and the long leg extended down the side of the cripple stud, as shown in Figure 1.1 and Figure 1.2 for double and single L-headers, respectively. Self-drilling screws (no. 8) were used to connect the L-shapes to the track sections, cripple studs, and king studs.

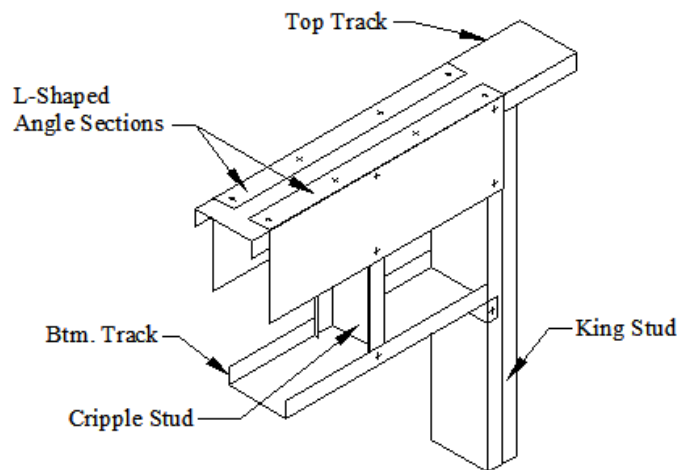

Figure 1.1 Double L-Header

Track sections used (362T125-33) had a minimum thickness of 33mils (0.84mm). Back-to-back cold-formed steel C-shaped studs (362S162-43) were attached to each end of the L-header, to simulate king studs. C-shape cripple studs consisted of 362S162-43 sections spaced 24 inches on center between the king studs. Drawings identifying the location of screws for each assemblies span are included in Appendix A.

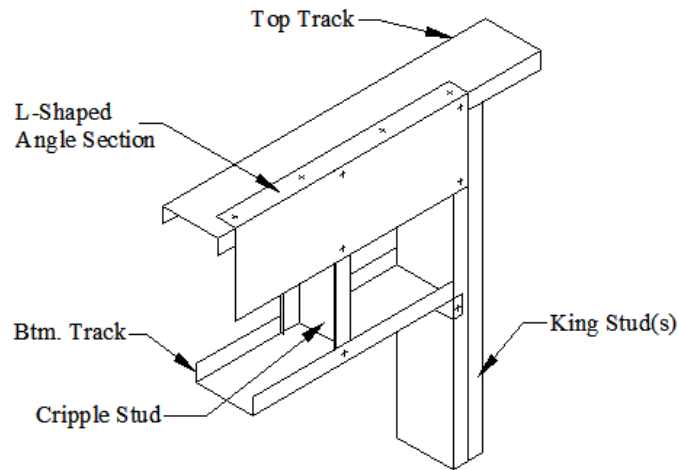

Figure 1.2 Single L-Header

Assembly designation is as follows: the first letter “D” or “S” represents double or single L-shape section, the first number is the vertical leg dimension (in.) of the L-shaped angle, the second number is the nominal thickness of the angle (in.), and the last number is the clear span (ft). The letter “A”, “B”, “C”, or “D” indicates the number of identical assemblies tested. Results are based on the average of two identical assemblies, if the results were within 10% of each other. If the results from the first two tests were not within 10% of each other further tests were performed and the average of all the tests was reported, unless notified otherwise. Uplift tests are identified with a ‘U’ at the end of the assembly designation. For example a D10-54-16B assembly designation represents a 16ft L-header assembly consisting of two L-sections with vertical leg depths of 10in., and thicknesses of 54mil. It is the second test for the D10-54-16 assemblies, tested under gravity loads.

Clear spans chosen for the tests were based on common spans used in construction and were the same as previous tests conducted by NAHB (NAHB-RC, 1998) and (NAHB-RC, 2003), for comparison purposes. For the double L-headers five different span lengths were tested: 3ft (0.91m), 6ft (1.83m), 8ft (2.44m), 12ft (3.66m), and 16ft (4.88m). For single L-

header assemblies three different span lengths were tested: 4ft (1.22m), 6ft (1.83m), and 8ft (2.44m).

1.3 SHORT SPAN TEST SETUP

Short span tests included clear spans ranging between 3ft (0.91m) to 6ft (1.83m) for both gravity and uplift loading. All short span tests were conducted using an H-frame universal testing machine in the Structures Lab at the University of Waterloo, equipped with a 35 kip (156 kN) maximum capacity actuator. A MTS Flex Test SE controller was used to control the hydraulics. While the data was acquired through National Instruments hardware and processed using a Labview virtual instrument (VI). The servo-hydraulics applied a constant rate of displacement of 1/20 inch (1.27mm) per minute to the assembly until failure was detected.

For the 3ft (0.91m) double L-header and 4ft (1.22m) single L-header assembly's tested under gravity loads mid-span deflections of the top track were recorded with a linear variable differential transformer (LVDT). Certain assemblies were retested with a linear motion transducer (LMT) attached to the bottom track in an effort to observe whether the bottom track deflection was less than the top track at mid-span. Under uplift loads, mid-span deflections were recorded with a LMT attached to the bottom track. For the 6ft (1.83m) assemblies, an LVDT measured the deflection of the top track at the location of the applied load (1/3 and 2/3 span), while the mid-span deflection was recorded using a LMT attached to the bottom track.

1.3.1 Gravity Tests

Gravity loads were applied to the assemblies to observe the flexural behavior and strength under typical loading conditions. The 3ft (0.91m) double L-header and 4ft (1.22m) single L-header assemblies were loaded with a single point load applied at mid-span over a cripple stud. The load was applied using a steel bearing plate with a contact area of 1.5 in. x 4 in. (38mm x 102mm). The two end-studs (king studs) on either end were positioned in fabricated base supports. The supports allowed the king studs to rotate in the plane of bending, while restraining the king studs from out of plane bending and lateral movement. Figure 1.3, shows the typical setup used for the 3ft and 4ft spans. Additional lateral braces

were not provided for the short span assemblies, since the unsupported length of the compression flange was relatively short, thus, flexural-torsional buckling was prevented.

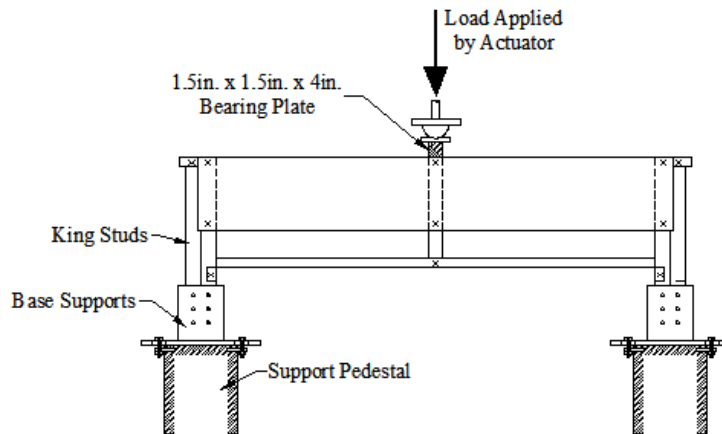

Figure 1.3 Gravity Load Case – Schematic 3ft and 4ft Test Setup

The 6ft (1.83m) double and single L-header assemblies were loaded by two point loads at 1/3 and 2/3 span. A spreader beam was attached to the universal testing machine and distributed the loads equally to the two cripple studs. Loads were applied through steel bearing plates with a contact area of 1.5in. x 4in. (38mm x 102mm), positioned directly above the cripple studs 24in. (610mm) on center. As with the shorter assemblies, the two king studs on each end were positioned into fabricated base supports. Shown in Figure 1.4 is the typical setup used for the 6ft (1.83m) spans.

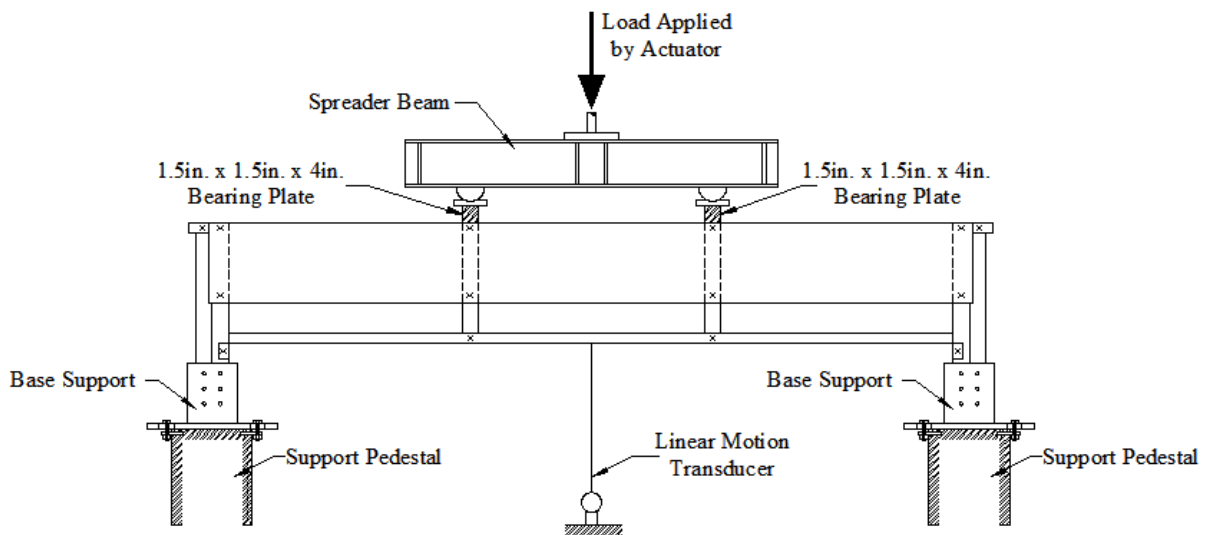

Figure 1.4 Gravity Load Case – Schematic 6ft Test Setup

1.3.2 Uplift Tests

Uplift loads were applied to the structures to observe the flexural behavior and strength of the assemblies under loads caused by wind. Attachments simulating strapping were fabricated and used to apply the tensile loads to each assembly. The attachments extended down the side of the cripple studs and were attached using 5 - #10 self-drilling screws to each side of the assemblies at the location of the cripple studs. The short 3ft (0.91m) double and 4ft (1.22m) single L-header assemblies' were loaded using a single attachment at mid-span as shown in Figure 1.5.

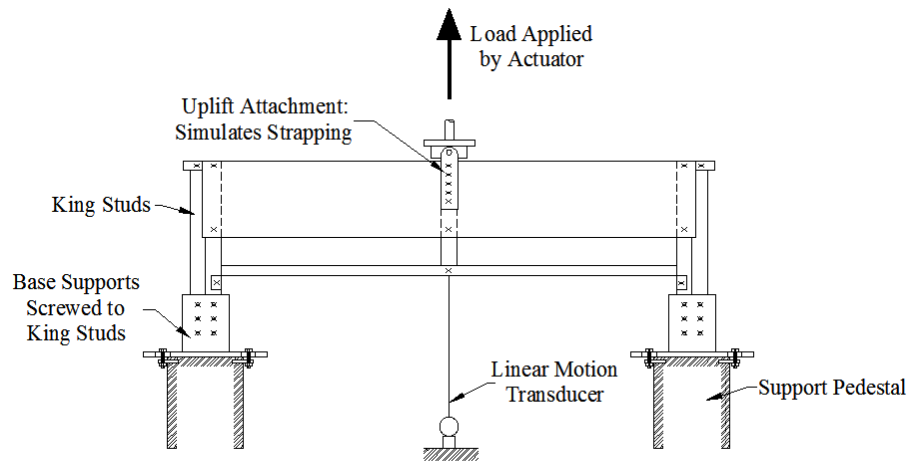

Figure 1.5 Uplift Load Case – Schematic 3ft and 4ft Test Setup

For the 6ft assemblies loaded with two concentrated loads, two attachments were attached to a spreader beam 24in. (610mm) on center, as shown in Figure 1.6. The king studs were fastened into base supports, with a total of 12 - #10 screws per support. Under this configuration the straps also acted as lateral braces, therefore, no additional lateral braces were required.

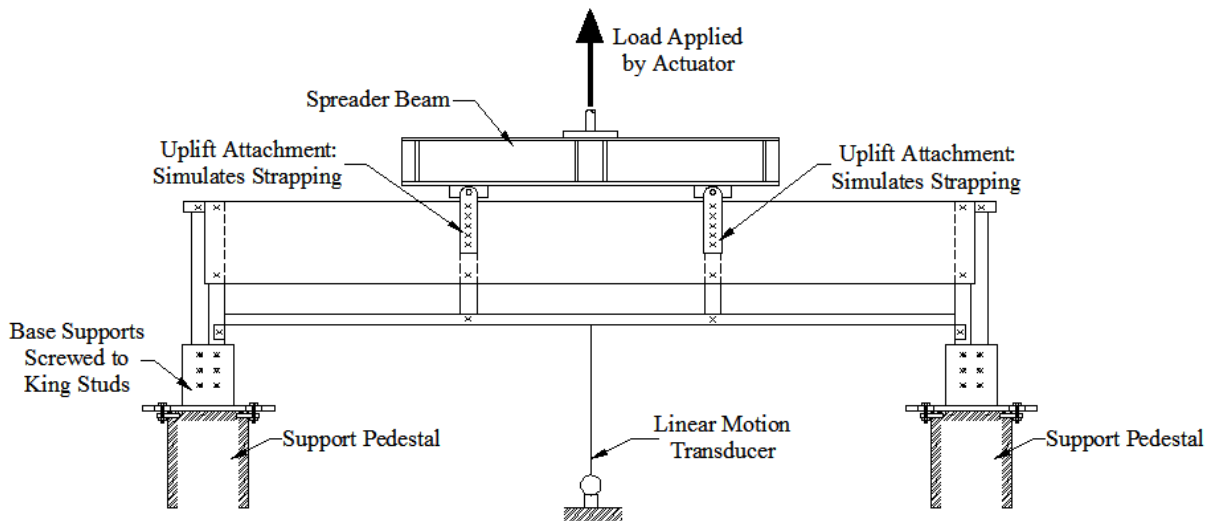

Figure 1.6 Uplift Load Case – Schematic 6ft Test Setup

1.4 LONG SPAN TEST SETUP

The long span L-header assemblies were tested using a Large Scale Hydraulic Truss Test Frame in the Structures Lab at the University of Waterloo, which applies equal loads at multiple points along the L-header assembly. This test frame operated under load control, rather than displacement control, which was used for the short span tests. As a result, an equivalent rate of loading of 1.1 kip (4.9 kN) per minute was used until failure. The constantly increasing load was controlled using a ramp generator connected to a MTS 406 controller. Loads were applied to the header assemblies through hydraulic cylinders; each of the cylinders had a maximum capacity of 10 kip (44.5 kN). Load cells were attached to each hydraulic cylinder in order to record the load applied by each cylinder, as shown in Figure 1.7. To ensure the loads from each hydraulic cylinder were comparatively equal the operating pressure of the hydraulics was reduced from 3,000 psi (20,684 kPa) to 1,000 psi (6,895 kPa). Using a lower pressure, the applied loads through the hydraulic cylinders were typically within 0.13 kip (0.6 kN) of each other.

Deflections were recorded using LMT's attached to the bottom track at mid-span, at $\frac{1}{4}$ span, and at $\frac{3}{4}$ span locations. Data from the load cells and LMT's was acquired through National Instruments hardware and processed using a Labview virtual instrument (VI).

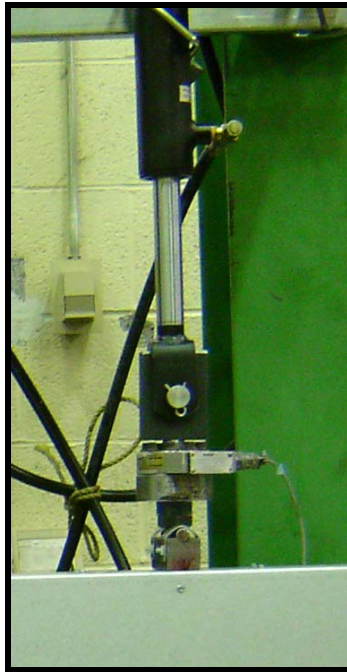

Figure 1.7 Long Span Load Cell Attachments

1.4.1 Gravity Tests

The 8ft (2.44m), 12ft (3.66m), and 16ft (4.88m) assemblies were loaded directly at the locations of cripple studs with 3, 5, and 7 point loads, respectively. Loads were applied to the header assemblies using steel bearing plates with contact areas of 1.5 inch x 4 inch (38 mm x 102 mm), as illustrated in Figure 1.7. The king studs were positioned in base supports. The supports allowed the king studs to rotate in the plane of bending, while restraining the king studs from out of plane bending and lateral movement. As the focus of this test program was to principally determine the behavior under in-plane bending, flexural-torsional buckling was prevented by providing full height lateral braces, as shown in Figure 1.8. Two lateral braces were positioned on each side of the assembly. For the 8ft (2.44m) assemblies the braces were positioned 6 in. (152mm) on either side of mid-span. For the 12ft (3.66m) assemblies the braces were positioned 18 in. (457mm) on either side of mid-span, and for the 16ft (4.88m) assemblies the braces were positioned 30 in. (762mm) on either side of mid-span.



Figure 1.8 Gravity Load Case - Long Span Test Setup

1.4.2 Uplift Tests

As with the short span tests, attachments simulating strapping were fabricated and used to apply the tensile loads to the assemblies. The attachments extended down the side of the cripple studs and were attached using 2 - #10 screws to each side of the assemblies at the location of cripple studs. The king studs were fastened to the base supports with a total of 12 - #10 screws per support. Figure 1.9 illustrates the typical test setup used for the long span uplift tests. In this loading configuration the straps also act as laterally braces, therefore additional lateral braces were not required.

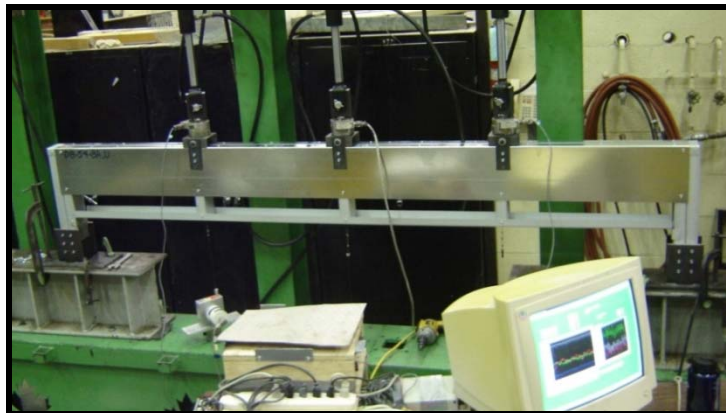

Figure 1.9 Uplift Load Case - Long Span Test Setup

1.4.3 Differences in Test Setup Compared to NAHB Research

The NAHB Research Center used two-point loading for all their long span tests conducted on double L-headers (NAHB-RC, 1998). Whereas the long span tests conducted in

this test program were loaded with multiple loads at 24 inches (610mm) on center. One of the main differences between the loading configurations was that with two-point loading the maximum moment is larger compared to multi-point loading under the same total applied load, for spans greater than 8ft (2.44m). Shown in Figure 1.10 are the respective differences in the shear force and bending moment diagrams for two-point and multi-point loading, under the same total load for a typical 12ft (3.66m) span.

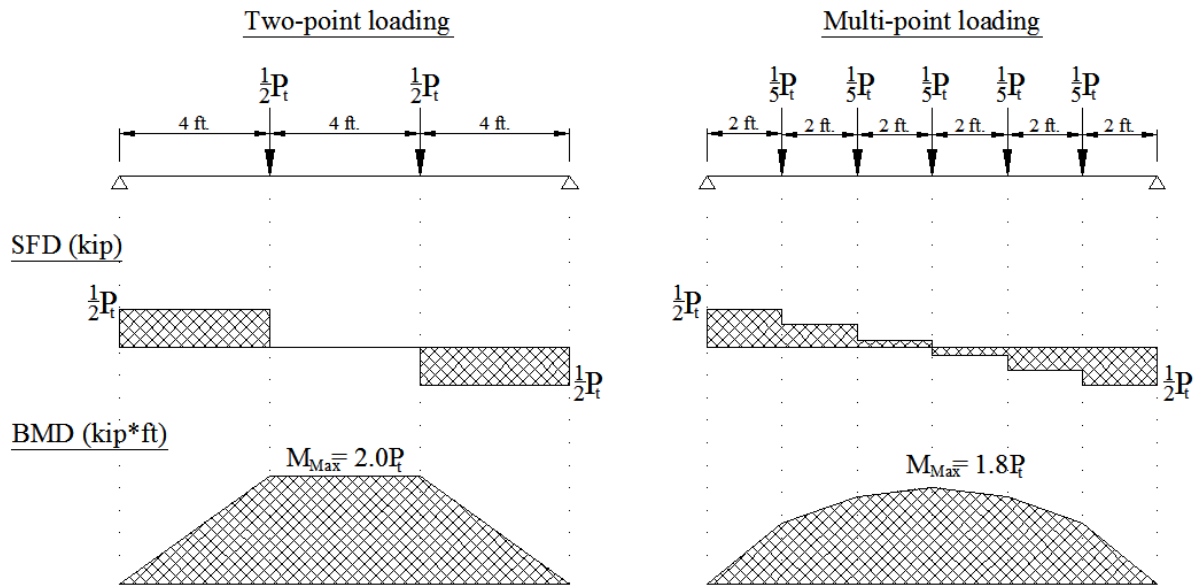

Figure 1.10 Comparison of Loading Configurations

For 12ft (3.66m) and 16ft (4.88m) spans, the mid-span moment is 11% and 17% larger under two-point loading, respectively. Furthermore, two-point loading results in zero shear force in mid-span region, while multi-point loading results in a non-zero shear force at mid-span. Under two-point loading certain failure modes are possibly overlooked.

Chapter 2

RESULTS / DATA ANALYSIS – GRAVITY LOADS

2.1 GENERAL

Data from the gravity load tests was collected in an effort to gain an understanding of the structural behavior of cold-formed steel L-headers. In particular, the flexural performance and deflection behavior were the main areas of interest. The nominal flexural strength as per the current AISI – Header Design Standard (AISI S212-07) was compared to the ultimate test moment in an effort to check the adequacy of the current design procedure. A new refined design approach has been proposed, based on tests summarized in this chapter, as well as tests previously conducted at the NAHB Research Center (NAHB-RC, 1998).

Given that there is currently no explicit deflection provisions for L-headers, deflection data was recorded for each assembly tested, in an effort to further understand the performance of the assemblies and ultimately produce a prediction equation for the vertical deflections of such assemblies.

2.2 OBSERVED FAILURE BEHAVIOR

Failure of single and double L-header assemblies was observed to be either a combination of flexure, web-crippling, and shear or purely flexural. For the 3ft (0.91m) double and 4ft (1.22m) single L-header assembly's, localized web failure was pronounced under the concentrated load, indicating web-crippling. Elastic shear buckling was also observed in the short span assemblies, as indicated by the diagonal tension field that can be seen at failure, as shown in Figure 2.1. Web crippling and shear buckling became less apparent for the 6ft (1.83m) assemblies. Assemblies longer than 6ft were observed to have buckled at mid-span, indicating purely flexural failure.

As the applied load increased for the short span assemblies, local buckling was first observed in the compression flange near the applied load. Local buckling refers to the phenomenon commonly experienced in cold-formed steel members, where elements appeared buckled however can still resist further loads. As the load was increased, local buckling became more apparent and the web section(s) began to bulge outwards at the king studs between the top and bottom screws, indicated the onset of elastic shear buckling

(Figure 2.1). At failure, the L-headers showed extensive buckling under the loading point, as well as considerable deformation at the king studs. Directly under the applied load, the web section appeared crushed, indicating that web crippling was experienced. Theoretically, the cripple studs located directly under the applied load are intended to prevent web crippling from occurring; however, under concentrated loads web crippling was evident, as shown in Figure 2.2.

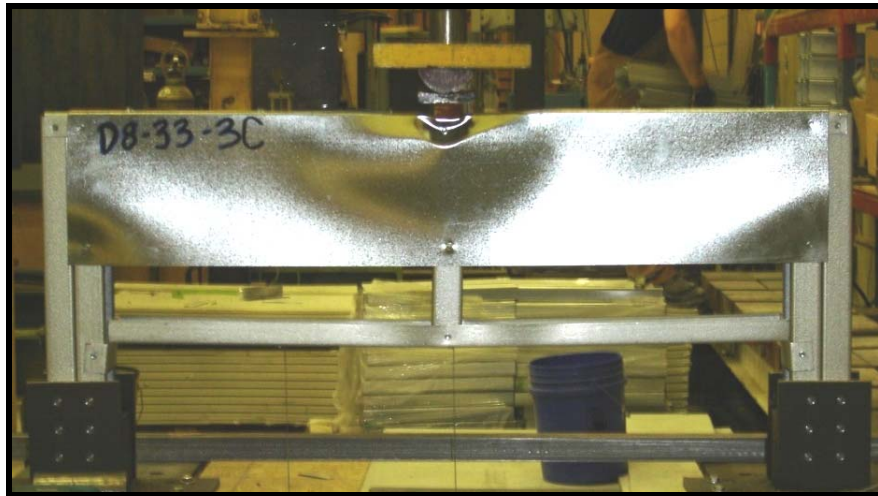

Figure 2.1 Gravity Load Case - Failure of Short Span Assemblies



Figure 2.2 Gravity Load Case - Web Crippling under Applied Load

For spans of 6ft (1.83m) or longer loaded with multiple point loads, local buckling of the compression flange between the loading points became particularly evident at about 50% of the ultimate load, as shown in Figure 2.3. The ultimate load was identified as the load at failure. With additional load, deformation of the web section(s) along the length of the

assemblies was noticeable; however, the diagonal tension field was not noticeable. At failure the long span assemblies showed extensive buckling of the compression flange and web section(s) at the location of failure, as shown in Figure 2.4.

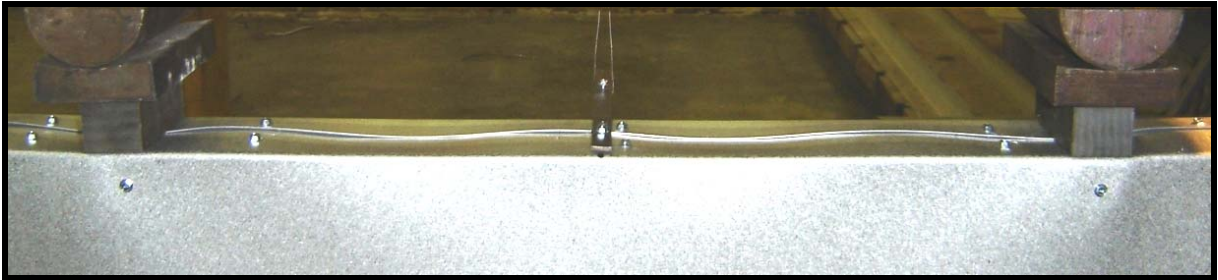

Figure 2.3 Gravity Load Case - Local Buckling of Compression Flange

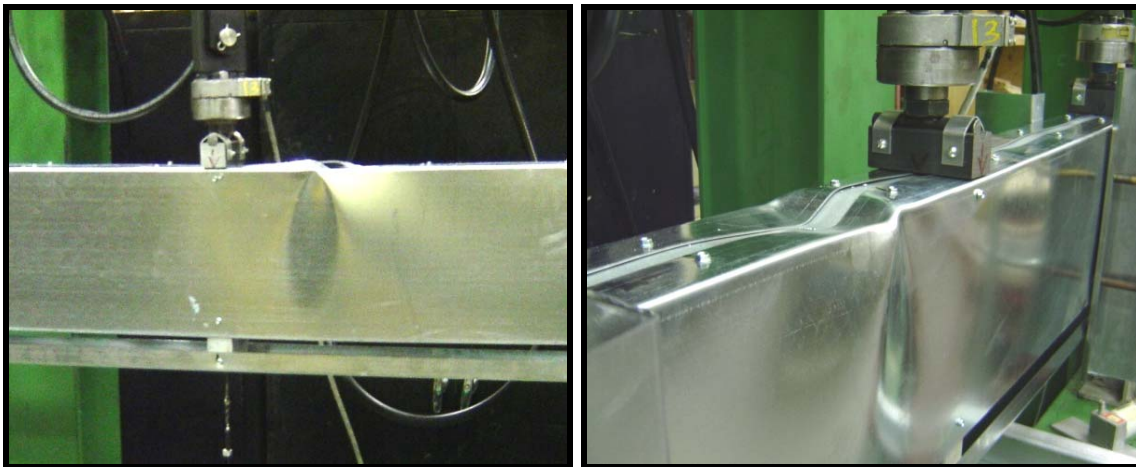

Figure 2.4 Gravity Load Case - Long Span Flexural Failure at Mid-span

For the 6ft (1.83m) assemblies failure typically occurred directly under the applied load; though, for spans greater than 6ft (1.83m) the assemblies did not fail directly under the applied load, rather failure typically occurred in the general vicinity of mid-span, as shown in Figure 2.4. Furthermore, no sign of web crippling was apparent directly under the applied loads, indicating pure flexural failure.

2.3 FLEXURAL STRENGTH – ULTIMATE LIMIT STATE

For the short span tests, the ultimate load applied at failure of each assembly was determined directly from the data acquisition output. Equations (2.1) and (2.2) were used to

calculate the ultimate test moment (M_t) based on the ultimate applied load (P_t). The test moments under gravity loads are identified by a 'g' subscript (M_{tg}).

For 3ft (0.91m) and 4ft (1.22m) assemblies:

$$M_t = \frac{P_t L}{4} \quad (2.1)$$

and for 6ft (1.83m) assemblies:

$$M_t = \frac{P_t a}{2} \quad (2.2)$$

Where P_t is the ultimate load at failure, L is the clear span length of the header, and a is the distance between cripple studs.

For the long span tests the ultimate load was defined as the summation of the individual loads applied at each cripple stud, at failure. The ultimate test moment (M_t) was calculated based on the individual loads at each cripple stud, as per eqs. 2.3, 2.4, and 2.5 depending on the clear span length.

Table 2.1 Long Span Ultimate Test Moment Equations

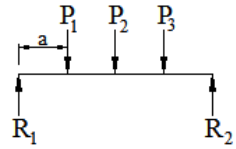
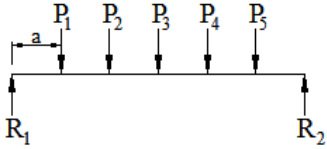
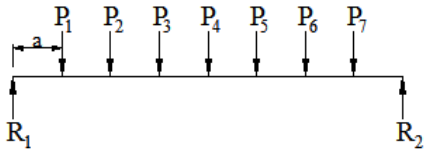
Span (L)	Loading Pattern	Ultimate Test Moment (M_t)
8ft (2.44m)		$M_t = R_1 \frac{L}{2} - P_1 a \quad (2.3)$
12ft (3.66m)		$M_t = R_1 \frac{L}{2} - 2P_1 a - P_2 a \quad (2.4)$
16ft (4.88m)		$M_t = R_1 \frac{L}{2} - 3P_1 a - 2P_2 a - P_3 a \quad (2.5)$

For each L-header assembly tested, the ultimate test moment was compared to the nominal flexural strength as per the *North American Specification for the Design of Cold-*

Formed Steel Structural Members (CSA S136-07) and to the recommended nominal gravity flexural capacity as per the *North American Standard for Cold-Formed Steel Framing - Header Design* (AISI S212-07). The nominal flexural strength as per Eq. (2.6), is based on the flexural strength of the L-section(s) only, assuming the track sections do not contribute to the strength of the assembly.

2.3.1 Double L-headers

As per the AISI - Header Design Standard (AISI, 2007), the nominal gravity flexural strength (M_{ng}) for L-header assemblies shall be calculated according to Eq. (2.6).

$$M_{ng} = S_{ec} F_y \quad (2.6)$$

Where F_y is the yield strength of the steel and S_{ec} is the effective elastic section modulus calculated at $f = F_y$ in the extreme compression fibers.

For double L-headers with a vertical depth of 8in. (203mm) or less, Eq. (2.6) shall be directly used. For L-header assemblies with a vertical depth of greater than 8in. (203mm) and with a span-to-vertical depth ratio equal to or greater than 10, Eq. (2.6) shall also be used. However, for L-header assemblies with a vertical depth greater than 8" (203mm) and a span-to-vertical depth ratio less than 10, the nominal flexural strength calculated as per Eq. (2.6) shall be multiplied by 0.9.

Actual measured mechanical properties were used in the calculation of the nominal gravity flexural strength. Summarized in Table 2.2 are the results of the double L-header gravity tests and the complete results are presented in Table B1 of Appendix B.

In general, the shortest and deepest L-header assemblies resulted in the lowest M_{tg}/M_{ng} ratios. Ratios of less than unity indicate the nominal flexural strength is over estimated. It was apparent even after applying the 0.9 modification factor as per the AISI - Header Design Standard, the nominal flexural strength is over-estimated for such short span assemblies. At such short clear spans it is probable that web crippling and shear forces are influencing the behavior of these assemblies. The cripple studs under the applied load are intended to prevent web crippling from occurring; however, web crippling was evident in test assemblies up to 6ft (1.83m) in length. Furthermore, the shortest L-header assemblies had span-to-depth ratios ranged between 3.6 and 6, shear deformation typically becomes a design concern for beams which have span-to-depth ratios of about 4. Given that the current design approach

only considers flexure as the failure mode, the strength of these short header assemblies is greatly over-estimated.

Table 2.2 Gravity Load Case - Double L-header Test Result Summary

Assembly Designation	No. of Tests	h/t	L/h	Average Ultimate Load P_t (kip)	Average Test Moment M_{tg} (kip*in.)	M_{ng} (kip*in.)	M_{tg}/M_{ng} (CSA S136)	M_{tg}/M_{ng} (AISI S212)
D6-33-3	2	182	6	3.61	32.5	27.5	1.18	1.18
D6-43-3	3	140	6	4.15	37.3	40.0	0.93	0.93
D6-54-3	2	111	6	6.00	54.0	55.7	0.97	0.97
D6-54-6	3	111	12	5.30	63.6	55.7	1.14	1.14
D6-43-8	2	140	16	4.05	64.2	37.5	1.52	1.52
D6-54-8	2	111	16	5.09	81.2	53.0	1.53	1.53
D8-33-3	3	242	4.5	4.30	38.7	52.5	0.74	0.74
D8-43-3	3	186	4.5	5.90	53.1	61.9	0.86	0.86
D8-43-6	2	186	9	5.88	70.5	61.9	1.14	1.14
D8-54-6	2	148	9	7.10	85.3	91.3	0.93	0.93
D8-43-8	2	186	12	5.47	87.1	61.8	1.41	1.41
D8-54-8	2	148	12	6.83	109	86.7	1.26	1.26
D8-54-12	2	148	18	5.21	114	86.7	1.32	1.32
D8-68-12	2	118	18	7.38	161	119	1.36	1.36
D8-54-16	2	148	24	4.32	122	87.6	1.40	1.40
D8-68-16	2	118	24	5.90	165	120	1.38	1.38
D10-33-3	2	303	3.6	4.84	43.5	78.9	0.55	0.61*
D10-43-3	2	233	3.6	5.97	53.8	92.3	0.58	0.65*
D10-43-6	2	233	7.2	7.18	86.1	92.3	0.93	1.04*
D10-54-6	2	185	7.2	9.22	111	135	0.82	0.91*
D10-43-8	2	233	9.6	6.87	109	92.1	1.19	1.32*
D10-54-8	2	185	9.6	8.57	137	128	1.06	1.18*
D10-54-12	2	185	14.4	7.40	162	128	1.26	1.26
D10-68-12	2	147	14.4	9.14	199	174	1.14	1.14
D10-54-16	2	185	19.2	5.17	145	130	1.11	1.11
D10-68-16	2	147	19.2	7.19	201	176	1.14	1.14
Mean							1.11	1.13
Std. Dev.							0.26	0.25
COV							0.24	0.22

Metric Conversion: 1 kip = 4.448 kN, 1 kip*in. = 0.112 kN*m

* Nominal flexural strength was multiplied by 0.9 as per the AISI - Header Design Standard (AISI, 2007)

It can be observed from Table 2.2, as the span lengths increase, the M_{tg}/M_{ng} ratios also increase. Assemblies with a span-to-depth ratio (L/h) of approximately 9 have M_{tg}/M_{ng} ratios of close to unity. For assemblies with L/h ratios of less than 9, M_{tg}/M_{ng} ratios are consistently less than unity. Furthermore, as the L/h ratio increases beyond 9, the nominal flexural strength calculated based on the AISI - Header Design Standard becomes conservative.

The slenderness ratio of the L-section (h/t) also tends to influence the nominal flexural strength. Results indicate that the lowest M_{tg}/M_{ng} ratios were obtained for short span assemblies with large slenderness ratios. The tests indicated that these assemblies experienced extensive local buckling, which causes the effective width to reduce and in return lowering the flexural strength of the assembly. However, the theoretical nominal flexural strength is calculated based on the effective section properties as per the North American Specification (CSA, 2007), in which the maximum slenderness ratio of 60 is greatly exceeded. It therefore becomes apparent that for unstiffened elements under stress gradient that exceed the slenderness ratio criterion, the effective width calculation could be perhaps over-estimated. As the slenderness ratio of L-header assemblies decreased, the M_{tg}/M_{ng} ratios increased closer to unity.

Flexural failure became increasingly predominant in long span assemblies. For such assemblies the nominal flexural strength calculated as per the AISI - Header Design Standard (AISI, 2007) resulted in accurate or underestimated strength values. Underestimated strengths became increasingly frequent at spans greater than 8ft (2.44m). As a simplification, the ultimate test moment was calculated based on pinned end connections. Pinned end-connections have a theoretical rotational stiffness of zero. At spans of 8ft (2.44m) or greater, it became evident that the connections between the L-sections and the king studs provided an inherent stiffness; therefore, acting as semi-rigid connections rather than pinned end connections. For semi-rigid connections, the end-fixity factor as given in Eq. (2.7) reflects the relative stiffness of the end connections (Xu, 2001).

$$r = \frac{1}{1 + \frac{3EI_{ec}}{RL}} \quad (2.7)$$

Where EI_{ec}/L is the effective flexural stiffness of the L-header(s) and R is the end connection rotational stiffness. For pinned connections the end-fixity factor is zero ($r = 0$),

while rigid end connections have an end-fixity factor of one ($r = 1$). Semi-rigid members have end-fixity factors ranging between zero and one. For members with a rotational stiffness greater than zero, end moments can develop, which in return would lower the mid-span moment and ultimately reduce the M_{tg}/M_{ng} ratios. Although, without directly measuring the rotation of the end connections, the magnitude of end moments developed cannot accurately be predicted. Semi-rigid connections are further discussed in Section 2.5 with respect to vertical deflections, end connection rotational stiffness's are approximated based on equations relating the end-fixity factor to the mid-span deflection.

Presented in Section 2.4 is a new design approach for gravity loaded double L-headers which accounts for web crippling and shear affects in short spans and the increased resistance of long spans due to semi-rigid connections.

2.3.2 Single L-headers

For single L-headers as per the AISI Header Design Standard (AISI, 2007), assemblies with a vertical leg dimension of 6in. (152mm) or less, the nominal flexural strength shall be calculated according to Eq. (2.6). For single L-headers with a vertical depth greater than 6in. (152mm) but not greater than 8in. (203mm), the nominal flexural strength as per Eq. (2.6) shall be multiplied by 0.9. Single L-headers with depths greater than 8in. (203mm) and/or spans greater than 4ft (1.22m) are not covered in the AISI - Header Design Standard. Assemblies tested which exceeded either of these limitations were calculated based on Eq. (2.6) with no modification factor. Results of the single L-header gravity tests are summarized in Table 2.3 and the complete results are presented in Table B2 of Appendix B. Actual measured mechanical properties were used in the calculation of the nominal gravity flexural strengths.

The results of the single L-header assemblies follow the same trend as the double L-header assemblies. The short spans had the lowest M_{tg}/M_{ng} ratios, as the spans increased the M_{tg}/M_{ng} ratios also increased. As with the double L-headers, assemblies with L/h ratios of 9 had M_{tg}/M_{ng} ratios of approximately unity. Assemblies with L/h ratio of less than 9 consistently had M_{tg}/M_{ng} less than unity. Assemblies with L/h ratios greater than 9 resulted in underestimated nominal flexural strengths.

Table 2.3 Gravity Load Case - Single L-header Test Result Summary

Assembly Designation	No. of Tests	h/t	L/h	Average Ultimate Load P_t (kip)	Average Test Moment M_{tg} (kip*in)	M_{ng} (kip*in)	M_{tg}/M_{ng} (CSA S136)	M_{tg}/M_{ng} (AISI S212)
S6-33-4	3	182	8	1.50	18.0	13.7	1.31	1.31
S6-43-4	4	140	8	1.80	21.6	20.0	1.08	1.08
S6-33-6	3	182	12	1.72	20.6	13.7	1.50	1.50**
S6-43-6	2	140	12	2.11	25.3	20.0	1.26	1.26**
S6-43-8	2	140	16	2.26	35.6	18.8	1.90	1.90**
S6-54-8	2	111	16	2.68	42.3	26.5	1.60	1.60**
S8-33-4	4	242	6	1.73	20.7	26.3	0.79	0.88*
S8-43-4	4	186	6	2.44	29.2	31.0	0.94	1.05*
S8-54-4	2	148	6	2.81	33.8	45.6	0.74	0.82*
S8-43-6	2	186	9	2.61	31.3	31.0	1.01	1.01**
S8-43-8	2	186	12	3.01	47.2	30.9	1.53	1.53**
S8-54-8	2	148	12	3.98	62.7	43.3	1.45	1.45**
S10-33-4	3	303	4.8	2.18	26.1	39.5	0.66	0.66**
S10-54-4	4	185	4.8	3.51	42.1	67.6	0.62	0.62**
S10-43-6	2	233	7.2	3.50	42.0	46.1	0.91	0.91**
S10-54-6	2	185	7.2	4.60	55.2	67.6	0.82	0.82**
S10-43-8	2	233	9.6	3.77	59.4	46.0	1.29	1.29**
S10-54-8	2	185	9.6	4.64	73.1	64.2	1.14	1.14**
						Mean	1.15	1.17
						Std. Dev.	0.37	0.36
						COV	0.32	0.31

Metric Conversion: 1 kip = 4.448 kN, 1 kip*in = 0.112 kN*m

* Nominal flexural capacity was multiplied by 0.9 as per the AISI - Header Design Standard (AISI, 2007)

** Assemblies not covered in AISI – Header Design Standard (AISI, 2007)

With the restriction of the AISI - Header Design Standard (AISI, 2007) in regards to single L-headers, only five out of the eighteen assemblies fell within the size limitations outlined in the standard. Based on these tests, the AISI - Header Design Standard estimated the strength of the assemblies reasonably well. However, two of the five assemblies resulted in average M_{tg}/M_{ng} ratios below 0.90, implying that the nominal strengths are over-estimated. As a result, a new design approach which accounts for a wider range of single L-headers is discussed in Section 2.4.

2.3.3 Single L-headers vs. Double L-headers

Comparing the tested ultimate moment strength of single L-headers to that of equivalent sized double L-headers, the single L-headers consistently had strengths of just over 50% of the equivalent double L-header assembly. With the nominal flexural strength of the assemblies calculated based solely on the section modulus of the L-section(s) alone, doubling the section modulus for a double L-header assembly resulted in exactly double the theoretical nominal flexural strength. However, the actual strength obtained from the test is to some degree influenced by the top and bottom track sections; therefore, adding a second L-section to the assembly did not exactly double the tested capacity. For this reason, the single L-header assemblies resulted in slightly larger M_{tg}/M_{ng} ratios compared to the same size double L-header assembly.

2.3.4 Comparison to Previous NAHB L-header Tests

The testing procedure used at the University of Waterloo for the short span tests was based on the testing conducted at the NAHB Research Center (NAHB-RC, 1998) and (NAHB-RC, 2003). However, the long span tests conducted at the University of Waterloo were loaded under multiple point loads, while two-point loading was used for the tests at the NAHB Research Center.

In general, the results from the double L-headers tests conducted at the NAHB Research Center were comparable to those conducted here at the University of Waterloo. For the short span L-headers, the yield strength of the steel used in the NAHB Research Center tests were lower. As a result, the average total load and maximum moment for these headers were lower than those tested at the University of Waterloo. Nonetheless, comparisons of the M_{tg}/M_{ng} ratios show the results from the NAHB tests and those conducted at the University of Waterloo were comparable, typically within 10% of each other. Two assemblies resulted in ratios which vary considerably, both the D10-43-8 and D10-54-8 assemblies. For both assemblies the ultimate total load and maximum moment obtained at the University of Waterloo were considerably higher than those obtained at the NAHB Research Center.

For the long span headers where different loading configurations were implemented, the average ultimate load at failure for the NAHB tests and University of Waterloo tests were quite close. Although, the maximum test moments tended to be higher for the tests

conducted at the NAHB Research Center under the two-point loading configuration. Complete comparisons of results are included in Table B3 in Appendix B. From a theoretical stand point, in the case of pure flexural bending, the maximum moment at failure should be independent of the loading configuration. To verify the maximum moment at failure does not depend on the loading configuration, two additional assemblies were tested under two-point loading rather than multi-point loading. As previously discussed in Section 1.4.3, under equal total loads, two-point loading results in a higher maximum moment. Thus, in order for the maximum moments to be equivalent, the ultimate load under two-point loading should be slightly less than the ultimate load under multi-point loading. The results are summarized in Table 2.4.

Table 2.4 Multi-point vs. Two-point Loading Configuration

Assembly Designation	Loading Configuration	Ultimate Load, P_t (kip)	Maximum Test Moment, M_t (kip*in.)
D8-54-12A	Multi-point	5.17	113
D8-54-12B	Multi-point	5.25	114
	<i>Average</i>	5.21	114
D8-54-12A (2pt)	Two-point	4.74	114
D8-54-12B (2pt)	Two-point	4.76	114
	<i>Average</i>	4.75	114

Metric Conversion: 1 kip = 4.448 kN, 1 kip*in. = 0.112 kN*m

As shown in Table 2.4, although the two-point loaded assemblies resulted in slightly lower ultimate loads compared to the identical assemblies loaded under multi-point loading, the maximum moments under both loading configurations were mathematically identical.

Four foot (1.22m) single L-header assemblies tested at the NAHB Research Center resulted in higher ultimate loads compared to those tested at the University of Waterloo. Furthermore, the steel materials used in the NAHB tests generally had lower yield strengths than those of the materials used in the tests at the University of Waterloo. With lower tested flexural strengths and higher calculated nominal flexural strengths, all tests conducted at the University of Waterloo resulted in noticeably lower M_{tg}/M_{ng} ratios. Also, the M_{ng} values used in the previous analysis conducted by R.A. LaBoube (LaBoube, 2005) are based on the 2000 version of the AISI Specification (AISI, 2001a). Thus, the M_{tg}/M_{ng} ratios do not

exactly correlate with results obtained in this current investigation. Complete comparisons of the results for the single L-header assemblies are included in Table B4 of Appendix B.

2.4 PROPOSED FLEXURAL STRENGTH DESIGN EQUATIONS

Under gravity loads, both single and double L-headers were observed to fail under combined web-crippling, shear, and bending or pure bending. The current AISI – Header Design Standard (AISII, 2007) provisions make a simplification by assuming the strength of the assemblies is solely based on the flexural strength of the L-headers alone and do not take into consideration the effect of web-crippling or shear in the overall strength of the L-header assembly. It was found in this investigation that the current design provisions become conservative for long spans. The inherent rotational stiffness of the end-connections makes the assembly act as semi-rigid members. Comparison between the tests of this study and the current design provisions indicate a new design methodology is desirable.

In an effort to be consistent with the current design provisions, the new strength equations are based solely on the flexural strength of the L-shaped sections alone. However a modification factor is applied to the flexural strength to account for the influence of web-crippling and shear effects for short span assemblies, and the apparent end-connection rotational stiffness of the long span assemblies.

As previously discussed, the ratio of the tested moment to the nominal flexural strength (M_{tg}/M_{ng}) of the L-header assemblies were found to generally be effected by the slenderness ratio of the web section (h/t), and span-to-depth ratio (L/h) of the assemblies. Therefore, the proposed flexural strength design equations are based on four major parameters. These four parameters are: effective elastic section modulus (S_{ec}), yield strength (f_y), span-to-depth ratio (L/h), and web slenderness ratio (h/t). Both the effective section modulus and yield strength have a direct influence on the flexural strength of the assemblies. However, the span-to-depth ratio and web slenderness ratio are indirectly related to the flexural strength, and seem to be good indicators of other behaviors besides flexural behavior that are ultimately causing failure of the assemblies. Equations (2.8) and (2.9) are proposed as the new nominal flexural strength (M_{ng}) determination equations for double and single L-headers, respectively.

For double L-headers:

$$M_{ng} = 0.465 S_{ec} F_y \left(1 + 0.985 \left(\frac{L}{h} \right)^{0.4} \right) \left(1 - 0.025 \sqrt{\frac{h}{t}} \right) \quad (2.8)$$

and for single L-headers:

$$M_{ng} = 0.050 S_{ec} F_y \left(1 + 3.700 \left(\frac{L}{h} \right)^{0.8} \right) \quad (2.9)$$

Where S_{ec} is the effective section modulus computed at ($f = F_y$) of the extreme compression flange, F_y is the yield strength, L is the span length, h is the vertical depth of the L-section(s), and t is the thickness of L-section(s). The equations take the same general form as the web crippling equations currently used in the *North American Specification for the Design of Cold-Formed Steel Structural Members* (CSA, 2007). The bracketed terms can be thought as of correction factors, the first being a span-to-depth correction factor and the second a web slenderness correction factor. As indicated by Eq. (2.9) the slenderness ratio (h/t) correction factor for single L-header was found to have an insignificant effect on the strength and therefore is not required in the nominal flexural strength determination equation. The empirical equations were determined using a statistical analysis software package known as Statistical Analysis System (SAS, 2004). SAS is a powerful statistical analysis program which allows a non-linear multivariable model to be specified and coefficients that cause the fitted curve to minimize the sum of the squares of the residuals can be determined.

The empirical coefficients for the double L-header predictor equation were determined based on 56 tests conducted at the University of Waterloo, and 42 tests previously conducted at the NAHB Research Center on double L-headers (NAHB-RC, 1998). Summarized in Table B5 of Appendix B is a comparison of the actual and predicted flexural strengths.

The empirical coefficients for single L-header predictor equation were determined based on 48 tests conducted at the University of Waterloo. Table B6 in Appendix B summarizes the actual and predicted flexural capacities for single L-headers. Results from previous tests conducted at the NAHB Research Center (NAHB-RC, 2003) were not included since they were analyzed using the 2000 version of the AISI Specification (AISI, 2001a), thus the M_{tg}/M_{ng} ratios did not correlate with results obtained in this current investigation.

The relationship between the tested flexural strengths and the predicted nominal flexural strengths, as per Eqs. (2.8) and (2.9) is shown graphically in Figure 2.5 and Figure 2.6 for double and single L-header assemblies, respectively. The solid line on the plots represents an exact solution of M_{tg} equal to M_{ng} . Data points below the solid line indicate an overestimation of the flexural strength, while points above the line indicate an underestimation of the flexural strength. The region bound by the dashed lines represents the points which fall within 15% of the ideal solution.

For the double L-headers the average M_{tg}/M_{ng} ratio was determined to be 0.993, with a standard deviation of 0.143, and a coefficient of variance of 0.145. For the single L-headers the average M_{tg}/M_{ng} ratio was determined to be 1.01, with a standard deviation of 0.124, and a coefficient of variance of 0.124. The statistical data was used to determine the values of Ω (ASD factor of safety) and ϕ (LRFD resistance factor) according to Section F1 of the AISI North American Specification (CSA, 2007). With using a calibration program written by Baher Beshara, the Ω and ϕ factors were determined as summarized in Table 2.5.

Table 2.5 Gravity Load Case - Values of Ω and ϕ

Configuration	Ω (ASD factor of safety)	ϕ (LRFD resistance factor)
Double L-header	1.85	0.704
Single L-header	1.78	0.736

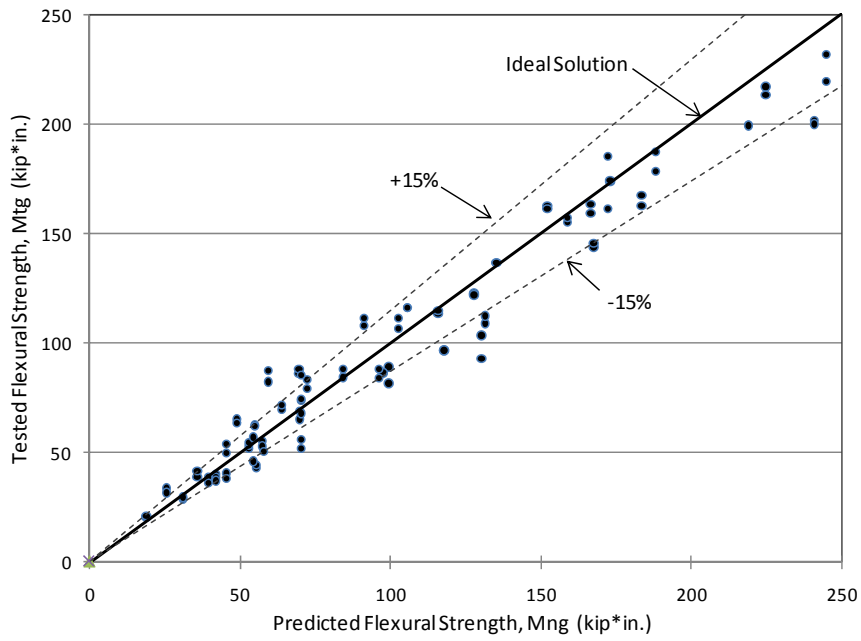

Figure 2.5 Gravity Load Case - M_{tg} Compared to M_{ng} for Double L-headers

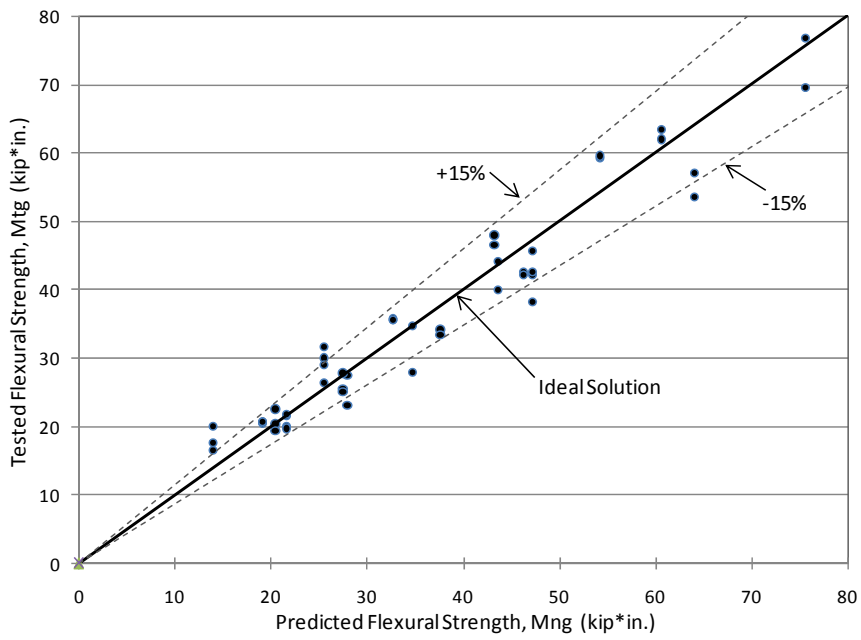

Figure 2.6 Gravity Load Case - M_{tg} Compared to M_{ng} for Single L-headers

2.4.1 Comparison between Current and Proposed Flexural Strength Equations

Based on the analysis of the data from the gravity loaded assemblies it is apparent the current design provisions (AISI, 2007) do not provide accurate predictions of the flexural strength for all L-header assemblies. As shown in Figure 2.7, the proposed nominal flexural strength equation produces M_{tg}/M_{ng} ratios that are consistently closer to an ideal solution of $M_{tg} = M_{ng}$, for double L-header assemblies. Figure 2.7 includes the results from all 56 tests conducted at the University of Waterloo and 42 tests previously conducted at the NAHB Research Center (NAHB-RC, 1998) on double L-headers.

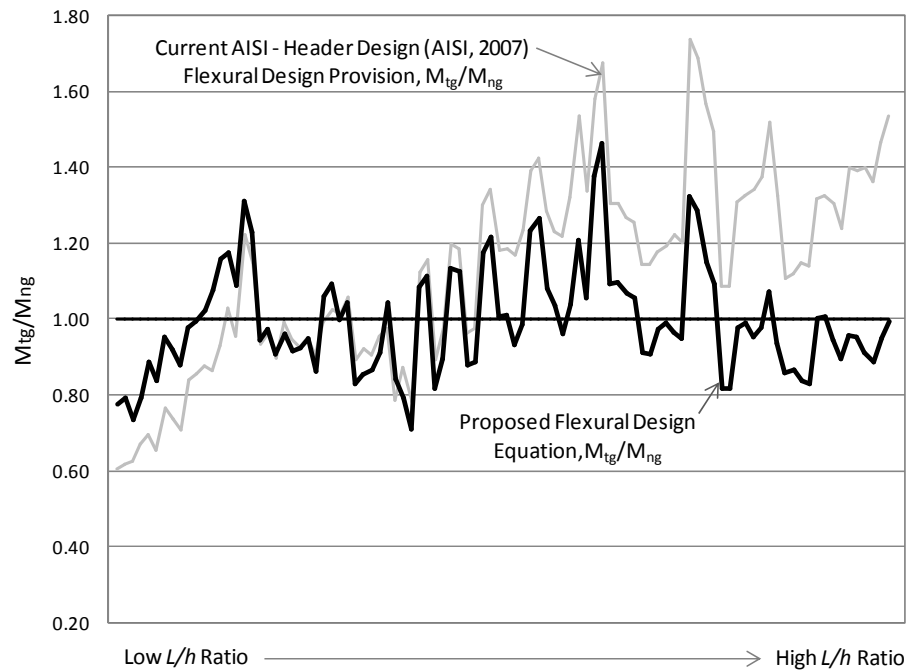

Figure 2.7 Gravity Load Case - Comparison between Current and Proposed Strengths

Based on 98 tests, the average M_{tg}/M_{ng} ratio when using the current AISI – Header Design Standard (AISI, 2007) nominal flexural strength provisions is 1.13, with a standard deviation of 0.26. Based on the proposed flexural strength equation for double L-headers, the average M_{tg}/M_{ng} ratio is 0.99, with a standard deviation of 0.14. With an average closer to an ideal solution and a lower variation in the results, it can be concluded that Eq. (2.8) increases the accuracy of predicting the flexural strength for double L-header assemblies. Furthermore, the proposed flexural strength equation reduces the extreme maximum and minimum M_{tg}/M_{ng} ratios. As can also be observed from Figure 2.7, the proposed flexural strength equation still

somewhat over-estimates the nominal flexural strength of assemblies with low span-to-depth ratios; however, the degree of over-estimation is reduced considerably. At large span-to-depth ratios the proposed flexural strength equation drastically increases the accuracy of the predicted flexural strength compared to the current AISI – Header Design Standard provisions.

2.5 DEFLECTION – SERVICEABILITY LIMIT STATE

Previous testing of L-header assemblies has provided limited deflection data. As a result, the current AISI - Header Design Standard (AISII, 2007) does not provide any guidance with regards to deflection computations. In an effort to further understand the behavior of L-headers and to provide future design guidance, vertical deflections were measured for each of the L-header test assemblies.

Generally, headers are designed to meet a minimum deflection criterion of $L/240$ under service loads. The $L/240$ deflection criterion is a rather lenient limitation, often stricter deflection requirements are necessary depending on the specific design protocol. For each L-header assembly tested the vertical deflection at mid-span was compared to the $L/240$ limit at 60% of the ultimate load. Sixty percent of the ultimate load was used as an approximation of the service load level.

2.5.1 Short Span L-headers

For the short span assemblies the mid-span deflection was measured using a linear variable differential transformer (LVDT) which was attached to the actuator applying the load to the assemblies. Thus, the deflection reading was an indication of the deflection of the top of the assembly. Since localized web crippling and shear was observed for the short spans it was anticipated the deflection readings of the top track would be greater than the mid-span bottom track readings. Furthermore, from a general perspective deflections of such assemblies are typically a greater concern when dealing with objects beneath the header assemblies; therefore, the deflection of the bottom track is of importance. In an effort to determine whether the bottom track was less susceptible to deflections three 3ft (0.91m) and four 4ft (1.22m) assemblies were retested with linear motion transducers attached to the mid-span of the bottom track. From the retests (D6-43-3C, D8-33-3C, D8-43-3C, S6-33-4C, S8-

43-4D, S10-33-4C, and S10-54-4D) it became evident that the deflections for the bottom track was less than the deflections of the top of the assembly. Complete deflection results for the short span assemblies are provided in Tables B7 and B9 of Appendix B. Theoretically, the deflection at the bottom of the assembly is less than the deflection of the top at the loading point because the deflection of the top includes the portion the L-section which crushes until contact is made with the top of the cripple stud, as shown in Figure 2.8.

Even the span deflections measured on the top of the assemblies at service load levels (60% of ultimate load), for each short span L-header assembly were typically less than the $L/240$ criterion, as summarized in Table 2.6.

Average deflections for the 3ft (0.91m) and 4ft (1.22m) assemblies listed in Table 2.6 are of the top of the assembly, the retests of the bottom track deflections are not included in the averages. Span deflections for the 6ft (1.83m) assemblies are of the bottom track.

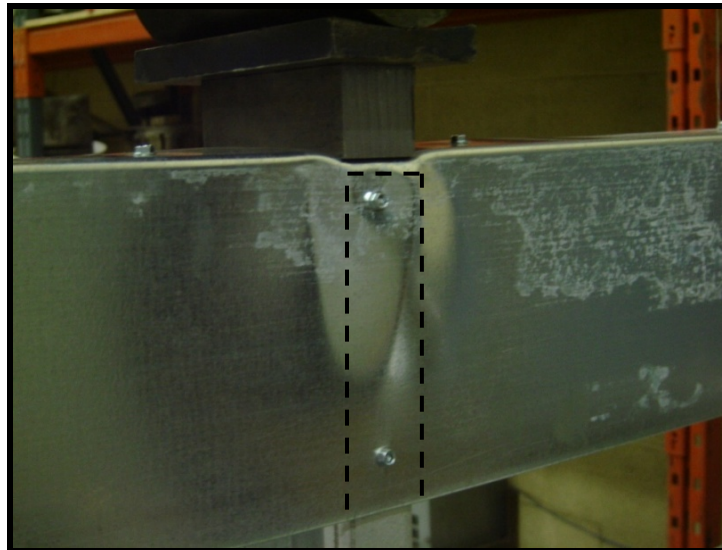

Figure 2.8 Gravity Load Case - Crushed Portion of L-header

Mid-span load-deflection curves for each assembly were compared to a predicted simply supported flexural deformation curve, as per Eqs. (2.10) and (2.11).

For 3ft (0.91m) and 4ft (1.22m) assemblies:

$$\Delta_{\text{midspan}} = \frac{PL^3}{48EI_{xc}} \quad (2.10)$$

And for 6ft (1.83m) assemblies:

$$\Delta_{\text{midspan}} = \frac{Pa}{24EI_{ec}} (3L^2 - 4a^2) \quad (2.11)$$

Where I_{ec} is the effective moment of inertia of the L-section(s) alone, computed at $f = F_y$. P is the applied load at each cripple stud, L is the clear span, a is the distance between point loads, and E is the modulus of elasticity of steel. Generally, with cold-formed steel members the effective widths of the elements constantly changes as the applied load increases, until yielding occurs in the extreme fiber. Thus, the effective moment of inertia will also constantly change, producing a non-linear load-deflection curve. As a simplification a constant effective moment of inertia calculated at $f = F_y$ has been used which produces a linear load-deflection curve. The stiffness of the short span assemblies was typically found to be less than that predicted by the simply supported model, as shown in Figure 2.9. As a result, the measured span deflections were larger than the predicted deflections from flexural deformation alone.

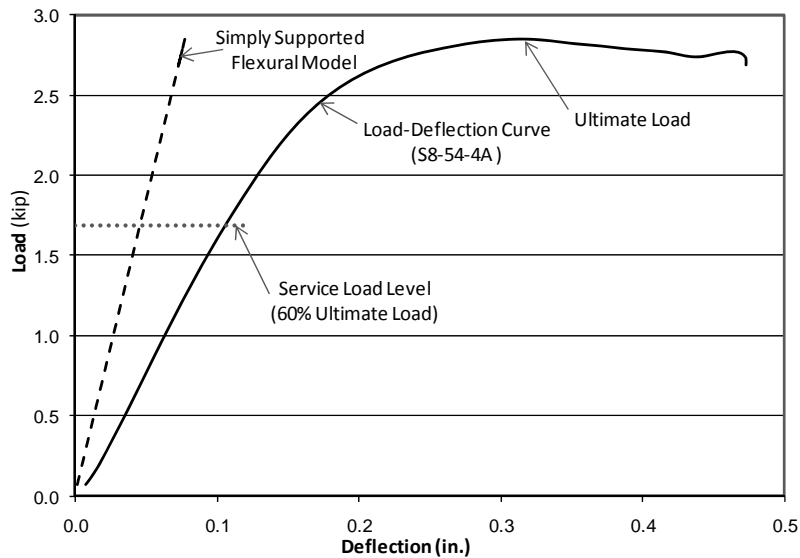

Figure 2.9 Gravity Load Case - Typical Short Span L-header Load-Deflection Curve

Table 2.6 Gravity Load Case - Short Span L-Header Deflection Data Summary

	Assembly Designation	No. of Tests	Mid-Span Defl. Reading Location	Average Ultimate Load P_t (kip)	Average Load at $L/240$ (kip)	$L/240$ Criterion (in.)	Average Deflection at Service Load Level (in.)
3ft Double L-headers	D6-33-3	2	Top	3.61	2.92	0.15	0.12
	D6-43-3	2	Top	4.22	3.18	0.15	0.12
	D6-54-3	2	Top	6.00	3.47	0.15	0.15
	D8-33-3	2	Top	4.38	3.92	0.15	0.10
	D8-43-3	2	Top	5.83	4.30	0.15	0.12
	D10-33-3	2	Top	4.84	4.13	0.15	0.10
	D10-43-3	2	Top	5.97	4.34	0.15	0.12
4ft Single L-headers	S6-33-4	2	Top	1.42	1.24	0.15	0.14
	S6-43-4	3	Top	1.73	1.50	0.15	0.14
	S8-33-4	4	Top	1.73	1.63	0.15	0.12
	S8-43-4	3	Top	2.37	2.02	0.15	0.14
	S8-54-4	2	Top	2.81	2.54	0.15	0.12
	S10-33-4	2	Top	2.11	1.96	0.15	0.13
	S10-54-4	3	Top	3.41	2.96	0.15	0.14
6ft Double L-headers	D6-54-6	2	Btm.	5.58	4.16	0.30	0.22
	D8-43-6	2	Btm.	5.88	5.76	0.30	0.15
	D8-54-6	2	Btm.	7.10	6.86	0.30	0.15
	D10-43-6	2	Btm.	7.18	*	0.30	*
	D10-54-6	2	Btm.	9.22	9.11	0.30	0.15
6ft Single L-headers	S6-33-6	3	Btm.	1.72	1.52	0.30	0.17
	S6-43-6	2	Btm.	2.11	1.83	0.30	0.18
	S8-43-6	2	Btm.	2.61	2.20	0.30	0.17
	S10-43-6	2	Btm.	3.50	2.96	0.30	0.15
	S10-54-6	2	Btm.	4.60	3.50	0.30	0.21

Metric Conversion: 1 kip = 4.448 kN, 1 in. = 25.4 mm

*Linear motion transducer not working correctly for tests – deflection data irrelevant

Given that the mid-span deflection for the tested assemblies was consistently greater than the simply supported theoretical model, other factors not just flexural stresses are influencing the vertical deflections. Shear deformations are typically neglected; however, at short spans deflections from shear can become significant. Shear deformations were incorporated using Eq. (2.12).

$$\Delta_{shear} = \frac{PL}{4Ght} \quad (2.12)$$

Where P is the applied load, L is the span, G is the shear modulus of steel, h is the vertical depth of the L-section(s), and t is the thickness of the L-section(s). The impact the shear deformation had on the overall deflection is summarized in Table 2.7. As indicated by Table 2.7 shear has a higher significance at low span-to-depth ratios.

Table 2.7 Gravity Load Case - Shear Deformation Contribution

Assembly Designation	L/h	Shear Contribution
D6-33-3	6	8.2%
D6-43-3	6	8.5%
D6-54-3	6	8.8%
D8-33-3	4.5	13.2%
D8-43-3	4.5	13.6%
D10-33-3	3.6	18.8%
D10-43-3	3.6	19.3%
S6-33-4	8	4.8%
S6-43-4	8	5.0%
S8-33-4	6	7.9%
S8-43-4	6	8.2%
S8-54-4	6	8.3%
S10-33-4	4.8	11.5%
S10-54-4	4.8	12.0%

Even after adding the shear contribution to the flexural deformation the predicted stiffness is still greater than the actual stiffness of the tested assemblies. For the short span L-header assemblies web crippling was observed as a failure mechanism. Consequently, the localized deformations directly under the applied load; caused by web crippling, need to be included in the mid-span deflection prediction model.

A deflection prediction equation has been developed; however, since the tests of the 3ft (0.91m) and 4ft (1.22m) assemblies recorded the deflection of the top of the assemblies and it was shown the bottom deflects less, the prediction equation was developed excluding the short span results. The deflection prediction equation is further discussed in Section 4.6.

2.5.2 Long Span L-headers

As with the short span assemblies, the maximum span deflection at service load levels was compared to the $L/240$ criterion for the long span assemblies. Results are summarized in Table 2.8. For each span it was evident the shallowest and thinnest L-headers either barely met or failed the $L/240$ criterion. The stiffer assemblies easily met the $L/240$ criterion.

Table 2.8 Gravity Load Case - Long Span Deflection Data Summary

Assembly Designation	No. of Tests	Average Ultimate Load, P_t (kip)	Average Load at $L/240$ (kip)	$L/240$ (in.)	Average Deflection at Service Load Level (in.)
D6-43-8	2	4.05	2.43	0.40	0.40
D6-54-8	2	5.09	3.02	0.40	0.40
D8-43-8	2	5.50	4.42	0.40	0.26
D8-54-8	2	6.83	4.93	0.40	0.32
D10-43-8	2	6.87	6.21	0.40	0.22
D10-54-8	2	8.57	7.48	0.40	0.23
D8-54-12	2	5.21	3.36	0.60	0.55
D8-68-12	2	7.38	4.27	0.60	0.63
D10-54-12	2	7.40	5.61	0.60	0.44
D10-68-12	2	9.14	6.72	0.60	0.47
D8-54-16	2	4.32	2.39	0.80	0.89
D8-68-16	2	5.90	2.88	0.80	1.03
D10-54-16	2	5.17	3.86	0.80	0.60
D10-68-16	2	7.19	4.54	0.80	0.75
S6-43-8	2	2.26	1.23	0.40	0.45
S6-54-8	2	2.68	1.58	0.40	0.41
S8-43-8	2	3.01	2.18	0.40	0.31
S8-54-8	2	3.98	2.58	0.40	0.36
S10-43-8	2	3.77	3.13	0.40	0.24
S10-54-8	2	4.64	3.57	0.40	0.29

Metric Conversion: 1 kip = 4.448 kN, 1 in. = 25.4 mm

The mid-span deflections for the long span assemblies were also compared to a predicted simply supported flexural deformation curve. Equations (2.13), (2.14), and (2.15) were used to predict the flexural deflections, depending on the length of the assembly. As indicated in Table 2.7 the influence of shear deformation becomes insignificant at larger span-to-depth ratios; therefore, shear contributions were not included for the long span assemblies.

For 8ft (1.83m) assemblies:

$$\Delta_{mid} = \frac{P}{48EI_{ec}} (6L^2a - 8a^3 + L^3) \quad (2.13)$$

for 12ft (3.66m) assemblies:

$$\Delta_{mid} = \frac{P}{48EI_{ec}} (18L^2a - 72a^3 + L^3) \quad (2.14)$$

and for 16ft (4.88m) assemblies:

$$\Delta_{mid} = \frac{P}{48EI_{ec}} (36L^2a - 288a^3 + L^3) \quad (2.15)$$

Where I_{ec} is the effective moment of inertia of L-header(s) alone, computed at $f = F_y$. P is the applied load at each cripple stud, L is the clear span, a is the distance between point loads, and E is the modulus of elasticity of steel.

As with the short span assemblies the effective moment of inertia was taken as a constant, calculated at $f = F_y$ which produces a linear load-deflection curve. The stiffness of the long span assemblies was typically found to be greater than that predicted value, as shown in Figure 2.10 for a typical long span assembly. As a result, the measured span deflections were smaller than the predicted deflections from flexural deformation alone.

The simply supported flexural predictor model is based on pinned end connections; though, as previously discussed the end connections of the L-headers provide some degree of end rotational restraint. Providing some degree of rotational restraint causes the L-headers to behave as semi-rigid members. With semi-rigid end connections the mid-span deflection will be less than predicted by the simply supported model. In order to accurately evaluate the span deflections a semi-rigid prediction model was created to take into consideration the rotational stiffness of the assemblies.

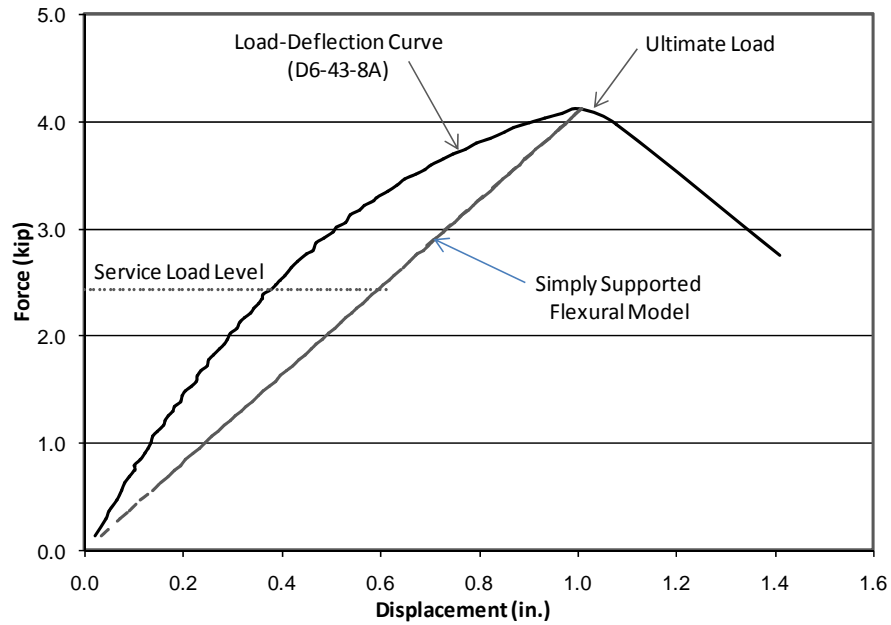

Figure 2.10 Gravity Load Case - Typical Long Span L-header Load-Deflection Curve

Connection flexibility was modeled using a rotational spring of zero length, as shown in Figure 2.11. Where the “@ symbol” represents the zero-length rotational spring, while R_1 and R_2 represent the stiffness of the springs.

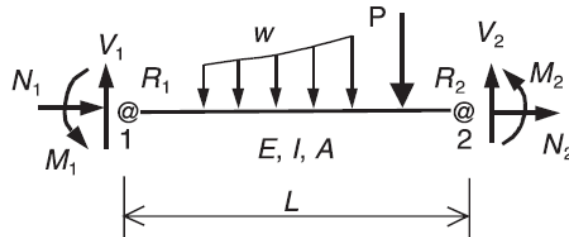

Figure 2.11 Semi-rigid Beam Member (Xu, 2001)

The end-fixity factor as previously defined, by Eq. (2.7) reflects the relative stiffness of the end connections (Xu, 2001). For pinned connections the end-fixity factor is zero ($r = 0$), while rigid end connections have an end-fixity factor of one ($r = 1$). Semi-rigid connections have end-fixity factors ranging between zero and one. As shown in Figure 2.12, the end-fixity factor has a drastic influence on the mid-span deflection. As the fixity factor increases from zero to one the mid-span deflection is considerably reduced, with a nearly linear relationship.

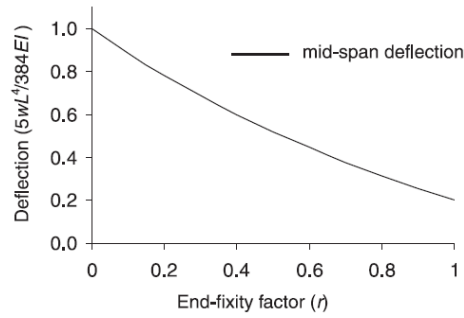

Figure 2.12 Deflection vs. End-fixity Factor (Xu, 2001)

Given that the measured span deflection of the tested L-header assemblies is less than that of a pinned end-connection, a certain end-fixity factor between ($0 < r < 1$) will cause the stiffness of the test assembly to equal the stiffness of the semi-rigid prediction model at a given point. As deflection evaluations are generally performed at the service load level, the semi-rigid prediction model was calibrated based on the service load level (60% ultimate load), as shown in Figure 2.13.

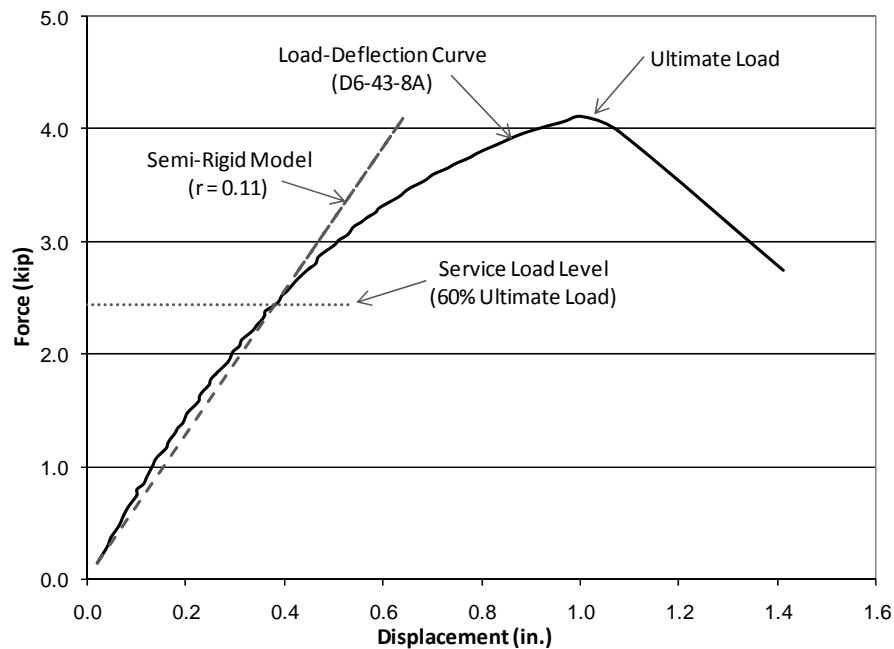

Figure 2.13 Gravity Load Case - Typical Semi-Rigid Deflection Model

The corresponding end-fixity factors were determined based on the deflection equations for semi-rigid members. In order to evaluate the deflection of semi-rigid members, the member end moments first need to be evaluated. The semi-rigid equations used to determine

the member end moments (M_1 and M_2) and mid-span deflection are shown in Figure 2.14. The corresponding m -values are listed in Table 2.9 (Xu, 2001). Where P is the applied load at a single cripple stud, and m_i is the corresponding m value listed in Table 2.9 used in the superposition method.

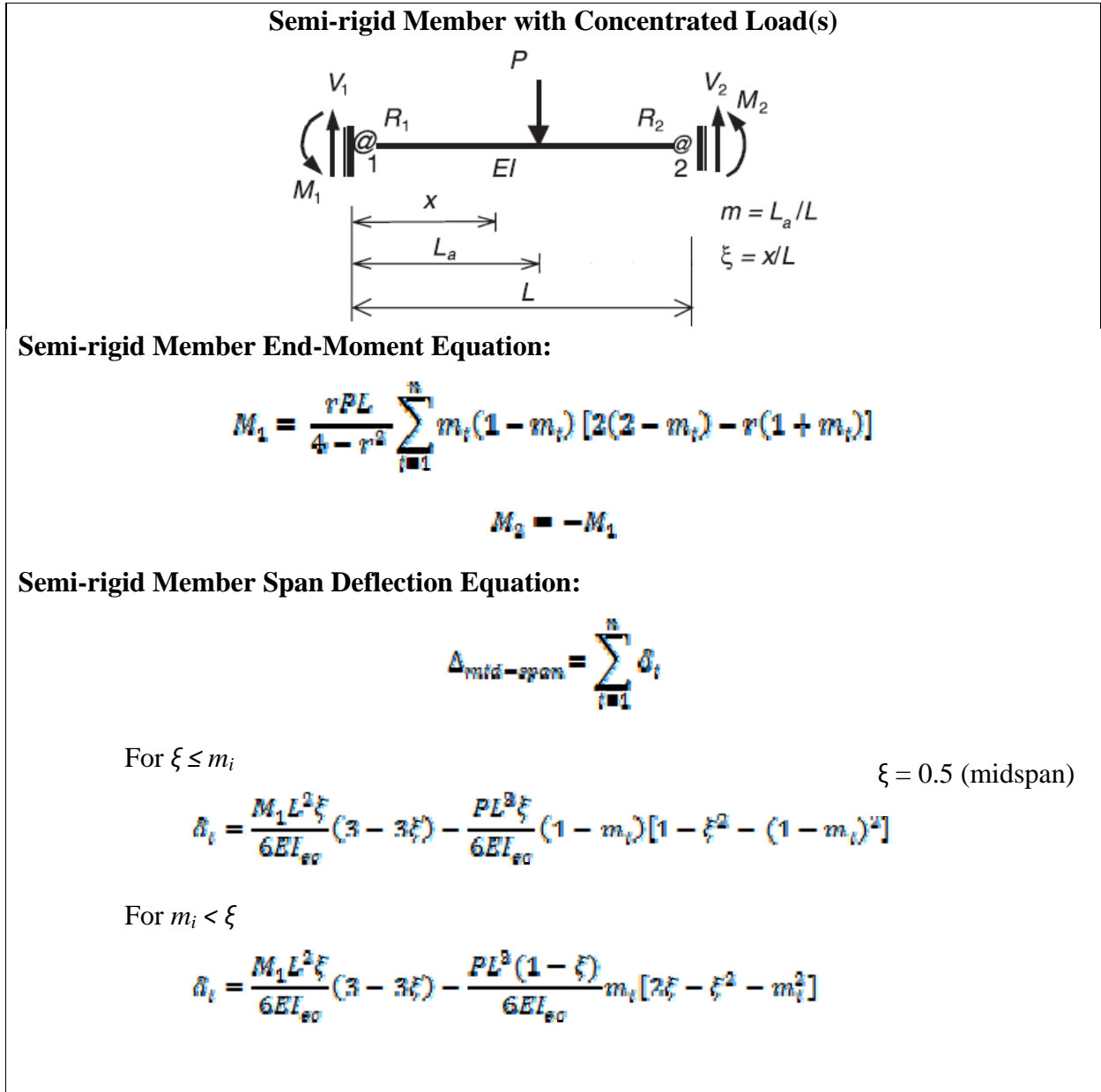
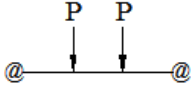
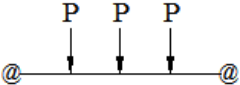
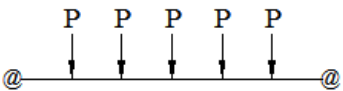
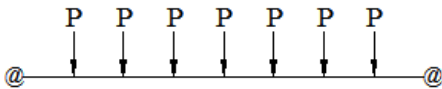

Figure 2.14 Semi-rigid Deflection Equations

Table 2.9 Semi-rigid Deflection m values

Span (L)	Loading Scheme	m values
6'		$n = 2$ $m_1 = 0.33, m_2 = 0.67$
8'		$n = 3$ $m_1 = 0.25, m_2 = 0.5, m_3 = 0.75$
12'		$n = 5$ $m_1 = 0.167, m_2 = 0.333, m_3 = 0.5$ $m_4 = 0.667, m_5 = 0.833$
16'		$n = 7$ $m_1 = 0.125, m_2 = 0.25, m_3 = 0.375, m_4 = 0.5$ $m_5 = 0.625, m_6 = 0.75, m_7 = 0.875$

For the L-header assemblies it was assumed that the end spring stiffness's are equal ($R_1 = R_2$) and the relative end-fixity factors are equal ($r_1 = r_2$). In order to evaluate the total end moment and span deflection for each assembly, the end moment and span deflection caused by each point load along the assembly were superimposed. P is the applied load at each cripple stud, it is assumed all point loads along the assembly are equal. For example, for a 8ft (2.44m) long L-header with a total ultimate load $P_t = 6$ kip (26.7 kN), $P = 2$ kip (8.9 kN). The effective moment of inertia, I_e is calculated at a constant stress level of $f = F_y$.

The tested L-header assemblies were found to have end-fixity factors ranging between 0 and 0.1 as summarized in Table 2.10. Generally, as the headers stiffness increased the end-fixity factor decreased. For a given header length increasing the depth or thickness results in increased assembly stiffness. Complete results for the analysis of the deflection results for the long span headers are included in Tables B8 and B10 of Appendix B.

Table 2.10 Gravity Load Case - Long Span L-header Semi-Rigid Property Summary

Assembly Designation	No. of Tests	L/h	h/t	End-Fixity Factor, r	End Stiffness, R (kip*in./rad.)
D6-43-8	2	16	140	0.10	199
D6-54-8	2	16	111	0.09	239
D8-43-8	2	12	186	0.08	370
D8-54-8	2	12	148	0.03	151
D10-43-8	2	9.6	233	0.03	221
D10-54-8	2	9.6	185	0.01	105
D8-54-12	2	18	148	0.05	198
D8-68-12	2	18	118	0.05	223
D10-54-12	2	14.4	185	0.05	330
D10-68-12	2	14.4	147	0.03	246
D8-54-16	2	24	148	0.05	134
D8-68-16	2	24	118	0.04	147
D10-54-16	2	19.2	185	0.04	231
D10-68-16	2	19.2	147	0.03	215
S6-43-8	2	16	140	0.10	100
S6-54-8	2	16	111	0.10	132
S8-43-8	2	12	186	0.06	136
S8-54-8	2	12	148	0.03	93.5
S10-43-8	2	9.6	233	0.02	73.4
S10-54-8	2	9.6	185	---	---

Metric Conversion: 1 kip*in./rad. = 0.112 kN*m/rad.

2.6 PROPOSED DEFLECTION PREDICTION EQUATION

At the service load level, from the analysis of the deflection data it became apparent that the actual span deflection for short-short span assemblies is significantly influenced by deformations other than just flexure. At low span-to-depth ratios it was concluded shear deformation can considerably increase the vertical deflection. However, it is presumed a substantial portion of the overall deflection is due to web crippling, thus determining the deflection based on theoretical equations would become very difficult.

As previously mentioned since the deflection records of the short 3ft (0.91m) and 4ft (1.22m) assemblies were taken from the top of the assembly rather than the bottom, the deflection data obtained from the these tests was not included in the development of the prediction equations.

For the long spans where web-crippling was not detected, the span deflections predicted solely based on the flexural deformation became conservative. The influence of the semi-rigid end connections theoretically explains this behavior. However, since the fixity factor for such assemblies was determined to be particularly low, accurately predicting the fixity factor is difficult. Furthermore, no general trends could be determined from the section properties of the L-header assembly and the corresponding fixity factor.

As a result, a simplified approach has been determined to predict the span deflection of gravity loaded L-headers, which accounts for the behavior of both short and long span assemblies. The approach assumes the span deflection is based solely on the flexural deformation, while a modification factor to the effective moment of inertia is used to account for the different behaviors of the assemblies. For 6 ft (1.83m) short span assemblies where the stiffness of the assemblies was determined to be less than that predicted, the modification factor is less than unity. While for long span assemblies where the predicted stiffness was less than the actual stiffness, the modification factor is greater to unity. The simply support flexural deformation equations presented previously shall be used with the effective moment of inertia (I_{ec}) replaced by the equivalent effective moment of inertia (I_{eq}). I_{eq} is defined by Eqs. (2.16) and (2.17) for double and single L-header assemblies, respectively. The equivalent moment of inertia has been calibrated to cause the predicted load-deflection curve to pass through the actual load deflection curve at 60% of the ultimate load, which was taken as the service load level. As a result, this approach will produce slightly conservative predicted deflections for total loads of less than the service load level, since the predicted load-deflection curve is linear. However, once the total load exceeds the service load level the predicted deflections will be underestimated.

For double L-headers: $6\text{ft (0.91m)} \leq L \leq 16\text{ft (4.88m)}$

$$I_{eq} = 0.94 \left(\frac{L}{h} \right)^{0.8} I_{ec} \quad (2.16)$$

and for single L-headers: $6\text{ft (0.91m)} \leq L \leq 8\text{ft (2.44m)}$

$$I_{eq} = 0.19 \left(\frac{L}{h} \right)^{1.0} I_{ec} \quad (2.17)$$

Where L is the span length of the assembly, h is the vertical depth of the L-shape, and I_{ec} is the effective moment of inertia calculated at $f = F_y$. The empirical equations were determined using the SAS statistical analysis software. The empirical coefficients

determined for double L-header assemblies were determined based on the results from 36 tests, with spans ranging between 6ft (1.83m) to 16ft (4.88m). The empirical coefficients for single L-header assemblies were determined based on the results 23 tests, with spans ranging between 6ft (1.83m) to 8ft (2.44m).

Summarized in Tables B11 and B12 in Appendix B are a comparison of the measured test deflection (Δ_{tg}) to the predicted deflection (Δ_g) at the service load level for double and single L-headers, respectively. The relationships are shown graphically in Figure 2.15 and Figure 2.16 for double and single L-header assemblies, respectively. The solid line on the plots represents an ideal solution of the test deflection equaling the predicted deflection. Data points below the solid line indicate an overestimation of the deflection, while points above the line indicate an underestimation of the deflection. The region bound by the dashed lines represents the points which fall within 15% of the ideal solution.

Although, the proposed procedure was not developed using the short span test data, the data from the retested assemblies with deflection records of the bottom track were included in the plots. For the 3ft (0.91m) double L-header assemblies the predicted deflections were slightly under-estimated, as shown in Figure 2.15. For the 4ft (1.22m) single L-header assemblies the results from the four retests indicate the deflections are overestimated, as shown in Figure 2.16. From a design perspective, deflections for short span assemblies are typically not of concern. As indicated from Table 2.6 all short span assemblies were under the $L/240$ criterion even with the larger top deflections.

For the single L-header assemblies it was observed the predicted deflections were significantly overestimated for a few 6ft (1.83m) assemblies as shown in Figure 2.16. Although, the deflections are overestimated the predicted deflections still meet the $L/240$ criterion.

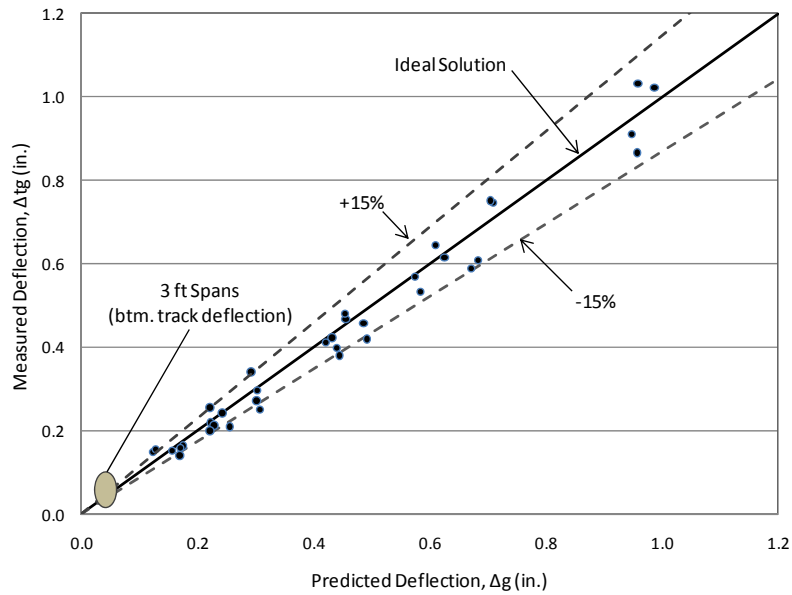

Figure 2.15 Gravity Load Case - Comparison of Δ_{tg} to Δ_g for Double L-headers

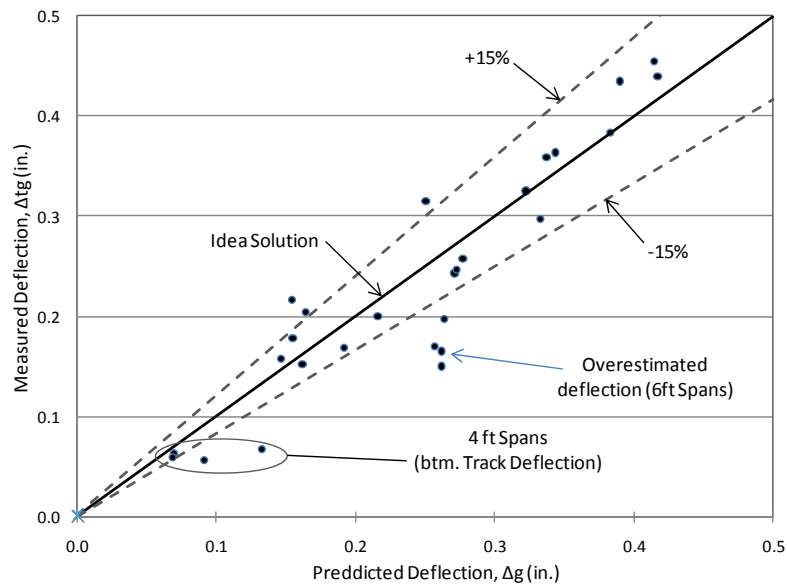

Figure 2.16 Gravity Load Case - Comparison of Δ_{tg} to Δ_g for Single L-headers

2.7 EFFECT OF GYPSUM BOARD ON L-HEADERS

The effect of adding a ½ in. (12.7mm) sheet of gypsum board to the L-header assembly was also investigated. Two different L-header assemblies were tested under gravity loads, while one assembly was tested under uplift loads with one sheet of gypsum board applied to

one side. The gypsum board covered the entire side of the assembly from the top track down to the bottom track. The gypsum board was attached to the L-header assemblies with self-drilling drywall screws; screw spacing was based on a 12in. (305mm) grid.

Under gravity loads gypsum board was tested on both D10-68-12 and S6-54-8 assemblies. For the long 12ft (3.66m) assemblies the gypsum board was attached to the assembly in such a manner that no splices were in the general region of mid-span. The results from the tests are summarized in Table 2.11. As indicated from the results the gypsum board has very little effect on the strength of large stiff L-header assemblies (D10-68-12); however, for assemblies with significantly lower stiffness (S6-54-8) the gypsum board appears to influence the strength considerably.

Table 2.11 Gravity Load Case - Gypsum Board Test Results

Assembly Designation	Gypsum Board	Ultimate Load (kip)	Maximum Test Moment (kip*in.)	Defl. @ Service Load Level (in.)
D10-68-12A	Yes	9.39	204	0.50
D10-68-12B	Yes	9.26	201	0.47
D10-68-12A	No	9.15	199	0.47
D10-68-12B	No	9.12	199	0.48
S6-54-8A	Yes	3.01	48.3	0.41
S6-54-8A	No	2.71	42.6	0.43
S6-54-8B	No	2.66	42.1	0.38

Metric Conversion: 1 kip*in. = 0.112 kN*m, 1 kip = 4.448 kN, 1 in. = 25.4 mm

A comparison of the load-deflection curves for the S6-54-8 assemblies with and without gypsum board is shown in Figure 2.17. It appears the gypsum board initially increases the stiffness of the assembly.

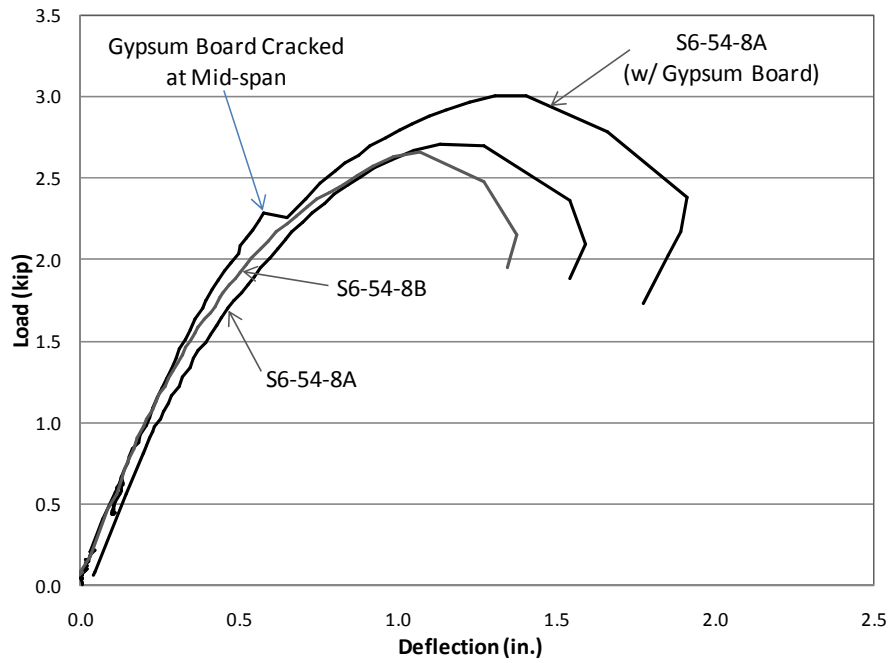

Figure 2.17 Gravity Load Case - Drywall Comparison Load-Deflection Curve

Once the gypsum board cracks a portion of the stiffness is lost. It is presumed once the gypsum board has cracked, the L-header would behave as though the no gypsum board is attached. However, from the one test performed it appears gypsum board actually showed a significant increase in the overall flexural strength. Due to limited tests it is inconclusive what the actual structural benefits of gypsum board would have on the L-header assemblies.

Chapter 3

RESULTS / DATA ANALYSIS – UPLIFT LOADS

3.1 GENERAL

In an effort to understand the structural behavior of L-headers under uplift loads, uplift data for a wide range of assemblies was recorded. In particular the flexural performance and deflection behavior were the main areas of interest. Currently, the AISI - Header Design Standard (AIS, 2007) does provide design guidance with regards to the flexural strength of double L-headers under uplift loads; however, no provisions are provided for single L-headers. Furthermore, serviceability criterion is absent for both double and single L-headers. In an effort to further understand the performance and ultimately predict the deflections for such assemblies deflection data was recorded for each tested assembly.

3.2 OBSERVED FAILURE BEHAVIOR

Failure of both single and double L-header assemblies under uplift loads was observed to be due to flexural and shear buckling of the web sections. Pure flexural buckling would seemingly occur in the highest flexural stress region (mid-span); however, the majority of the assemblies did not experience buckling failure at mid-span. For the short 3ft (0.91m) and 4ft (1.22m) assemblies loaded with a single point load, the web section(s) severely buckled at mid-span. For the 6ft (1.83m) assemblies the web section(s) between the load points and reactions experienced buckling failure, as shown in Figure 3.1. For the 8ft (2.44m) assemblies the web sections buckled at the first cripple stud from the end supports. While for the 12ft (3.66m) and 16ft (4.88m) assemblies, buckling of the web section(s) occurred at the second cripple stud from the end support. Pure flexural failure at mid-span was however observed for the D10-54-16 and D10-68-16 assemblies, as shown in Figure 3.2.



Figure 3.1 Uplift Load Case - Buckling Failure of Web Section (6' Assemblies)

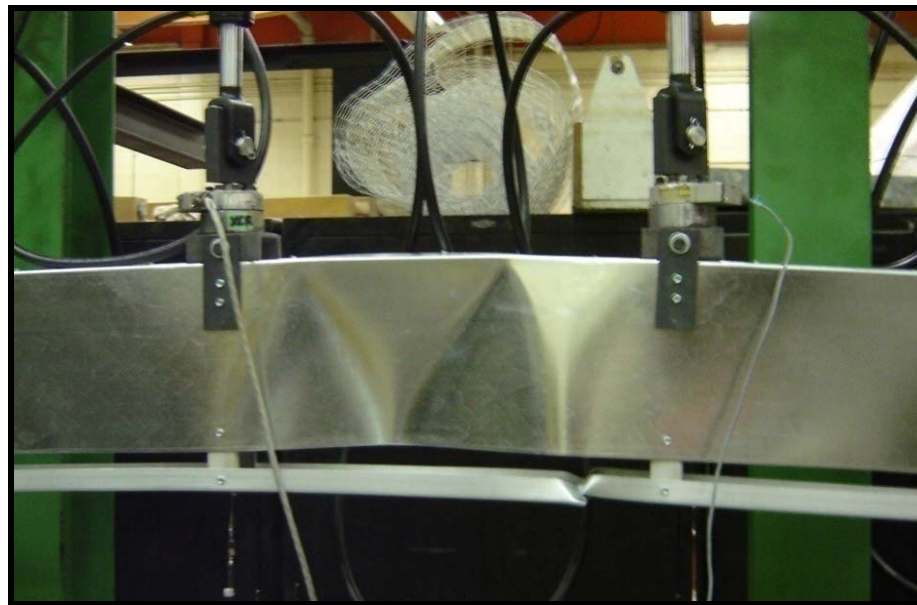

Figure 3.2 Uplift Load Case - Flexural Buckling of Bottom Track

Immediately after loading commenced, local buckling of the web sections between the loading points and reactions became visible, as shown in Figure 3.3. With an increase in load the screws attaching the L-section(s) to the king studs and cripple studs showed signs of excessive prying.



Figure 3.3 Uplift Load Case - Local Buckling of Web Section

Throughout the loading process, it was also observed that the king studs experienced bending. The two C-shaped stud sections screwed back-to-back simulating king studs were visually pried apart. As Figure 3.4 illustrates, the bottom screw attaching the L-header to the king stud were experiencing a pulling force, while the top screw was being pushed towards the king stud. As a result, a moment was created at the end connections.

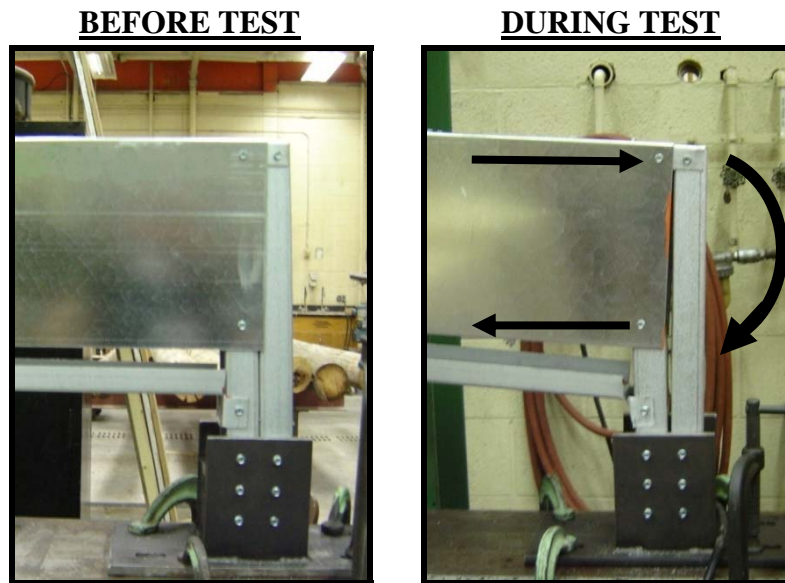

Figure 3.4 Uplift Load Case - Prying of King Stud

During testing of some of the thick 54mil (1.37mm) single and double short span L-header assemblies it was observed at peak loads the bottom screw(s) attaching the L-section(s) to the king studs, failed due to extreme prying (Figure 3.5). Short span assemblies which experienced screw failure (#8 self-drilling screws) at peak loads include: D10-54-3A, D10-54-6A, D10-54-6B, S8-54-4A, S8-54-4B, S10-54-6A, and S10-54-6B. In an effort to ensure screw failure was not a contributing factor to the ultimate capacity of the L-header assemblies, certain assemblies were retested with #10 screws instead of #8 screws.



Figure 3.5 Uplift Load Case - Screw failure at Ultimate Load

The assemblies which were retested with #10 screws were: D10-54-3B, D10-54-6C, and S8-54-4C. The retests indicated that the larger screws prevented prying failure, but had an insignificant effect on the flexural resistance of the assemblies. The assemblies with #8 screws failed suddenly, while the assemblies retested with #10 screws failed at roughly the same ultimate load, the assemblies seemed to behavior more ductile. As a result, #10 screws were used for all long span assemblies with L-section thicknesses greater than 54mil (1.37mm).

Even with the use of #10 screws for the long span assemblies failure of the screws was common when the peak load was prolonged. Figure 3.6 shows the load-deflection curve for a typical long span assembly which experienced buckling failure then screw failure. Given that the buckling failure consistently occurred prior to screw failure, it is presumed the buckling failure caused forces to redistribute and ultimately caused failure of the screws.

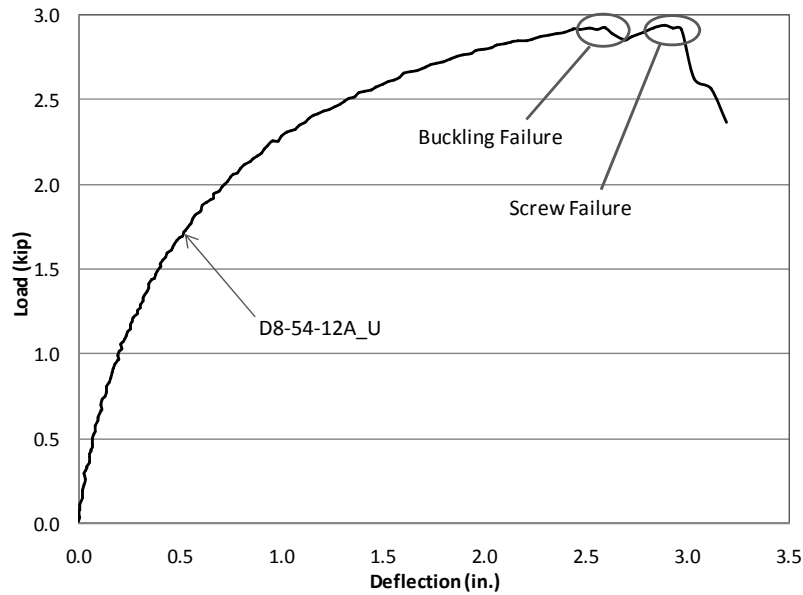

Figure 3.6 Uplift Load Case - Load-Deflection Curve Failure

3.3 FLEXURAL STRENGTH – ULTIMATE LIMIT STATE

For the short span tests the peak load at failure was directly obtained from the data acquisition output, from which the ultimate test moment (M_t) was computed based on Eqs. (2.1) or (2.2) depending on span. For the long span tests the total ultimate load was defined as the sum of the individual loads at each cripple stud, at failure. The ultimate test moment (M_t) was computed based on the individual loads at each cripple stud, as per Eqs. (2.3), (2.4), and (2.5) for 8ft (2.44m), 12ft (3.66m), and 16ft (4.88m) assemblies, respectively. Test moments obtained from uplift loads are identified by a “u” subscript (M_{tu})

For each L-header assembly tested, the ultimate test moment was compared to the nominal flexural strength as per Eq. (2.6) based on the *North American Specification for the Design of Cold-Formed Steel Structural Members* (CSA S136-07). The results were also compared to the recommended nominal uplift flexural strength as per the AISI - Header Design Standard (AISI 2007). The AISI - Header Design Standard however only covers double L-headers under uplift loads.

As previously discussed recent changes to the *North American Specification for the Design of Cold-Formed Steel Structural Members* (CSA, 2007) have resulted in a significant decrease in the section properties of L-headers under uplift loads. Therefore, section properties used in the determination of the uplift nominal strength are based on gravity loads,

which is currently the approach used in the *North American Standard for Cold-Formed Steel Framing – Header Design* (AISI, 2007).

3.3.1 Double L-headers

Currently, the AISI - Header Design Standard (AISI, 2007) suggests the nominal uplift flexural strength (M_{nu}) for double L-headers under uplift loads shall be computed based on Eq. (3.1).

$$M_{nu} = RM_{ng} \quad (3.1)$$

Where R is an uplift modification factor which is based on the depth-to-thickness ratio, for depth-to-thickness ratios less than or equal to 150, $R = 0.25$. For depth-to-thickness ratios greater than or equal to 170, $R = 0.20$. Linear interpolation shall be used to determine R for vertical leg-to-thickness ratios between 150 and 170. M_{ng} is the nominal gravity flexural strength computed in accordance to the AISI – Header Design Standard (AISI, 2007).

Table 3.1, summarizes the average results for double L-headers under uplift loads. Complete results for each assembly tested are included in Table B13 in Appendix B. For comparison purposes the nominal flexural capacity is based on the actual measured mechanical material properties.

The ratio of the ultimate test moment to the nominal flexural strength were found to be consistently well below unity, which was anticipated since the L-shape geometry under uplift promotes extensive local buckling, resulting in low ultimate test moments. Average M_{tu}/M_{ng} ratios ranged from 0.27 to 0.74, with a mean value of 0.52. Ideally the M_{tu}/M_{ng} ratio would be exactly unity, which would imply the predicted nominal flexural strength is equal to the ultimate test moment. A ratio less than unity implies the nominal strength is over-estimated, while values greater than unity suggests the nominal strength is conservative.

Further analysis shows the M_{tu}/M_{ng} ratio generally increases as the span-to-vertical depth ratio increases. Assemblies with the lowest span-to-vertical depth ratio were also found to have the lowest M_{tu}/M_{ng} ratio.

Table 3.1 Uplift Load Case - Double L-header Test Result Summary

Assembly Designation	No. of Tests	h / t	L / h	Average Ultimate Load P_t (kip)	Average Test Moment M_{tu} (kip*in)	M_{tu}/M_{ng} (CSA S136)	M_{tu}/M_{nu} (AISI S212)
D6-43-3	2	140	6	1.84	16.6	0.43	1.73
D6-54-3	2	111	6	2.82	25.4	0.45	1.79
D6-54-6	2	111	12	2.00	24.0	0.42	1.70
D6-43-8	3	140	16	1.79	28.8	0.75	3.02
D6-54-8	2	111	16	2.13	39.4	0.75	2.98
D8-33-3	2	242	4.5	2.24	20.1	0.56	2.78
D8-43-3	2	186	4.5	2.56	23.1	0.38	1.90
D8-43-6	2	186	9	1.72	20.7	0.34	1.70
D8-54-6	2	148	9	2.90	34.8	0.38	1.51
D8-54-8	2	148	12	3.44	55.5	0.64	2.57
D8-54-12	2	148	18	2.84	63.7	0.74	2.95
D8-68-12	2	118	18	3.18	70.6	0.60	2.38
D8-54-16	2	148	24	2.67	74.7	0.86	3.45
D10-43-3	2	233	3.6	3.35	30.2	0.33	1.85
D10-54-3	2	185	3.6	4.17	37.5	0.27	1.52
D10-54-6	2	185	7.2	2.89	34.6	0.25	1.41
D10-43-8	2	233	9.6	2.66	43.5	0.46	2.58
D10-54-8	3	185	9.6	3.75	60.8	0.48	2.64
D10-54-12	2	185	14.4	3.53	77.7	0.61	3.04
D10-68-12	2	147	14.4	3.82	83.8	0.48	1.93
D10-54-16	3	185	19.2	2.97	82.9	0.65	3.23
D10-68-16	2	147	19.2	3.36	93.7	0.55	2.19

Metric Conversion: 1 kip*in. = 0.112 kN*m, 1 kip = 4.448 kN

Presently, the approach for computing the nominal uplift flexural capacity as per the AISI – Header Design Standard (AISI, 2007) underestimates the strength significantly, resulting in excessively conservative designs. Average M_{tu}/M_{nu} ratios ranged between 1.51 to 3.45, with a mean of 2.34 and a standard deviation of 0.64, based on all the tests. Analysis of the results from tests conducted at the NAHB Research Center on double L-headers under uplift loads; which were used to develop the current uplift design provisions, indicate the peak failure loads of the tests conducted at the NAHB Research Center were considerably less than the peak loads obtained in this test program (NAHB-RC, 1998). However, without detailed loading information from the NAHB tests it is inconclusive what was classified as the failure

load. For the tests conducted within this test program, the failure load was taken as the peak load on the load-deflection curve. Therefore, from herein the double L-header uplift results obtained from the tests conducted at NAHB Research Center (NAHB-RC, 1998) are not included in the analysis or creation of the new proposed design equations.

3.3.2 Single L-headers

Currently, the *North American Standard for Cold-Formed Steel Framing – Header Design* (AISI, 2007) does not provide provisions for the nominal uplift flexural strength for single L-header assemblies. Various sizes of single L-headers up to a maximum span length of 8ft (2.44m) were tested under uplift loads in an effort to provide future design guidance.

As with the double L-header assemblies, the ultimate test moment under uplift (M_{tu}) of the single L-header assemblies was compared directly to the nominal gravity flexural strength, as per Eq. (2.6). Table 3.2 Summarized in Table 3.2 are the single L-header results. The results indicate similar trends as with the double L-headers.

Table 3.2 Uplift Load Case - Single L-header Test Result Summary

Assembly Designation	No. of Tests	h/t	L/h	Average Ultimate Load (kip)	Average Moment M_{tu} (kip*in.)	M_{tu}/M_{ng} (CSA S136)
S6-33-4	2	182	8	0.83	9.94	0.90
S6-43-4	2	140	8	0.84	10.1	0.55
S6-43-6	2	140	12	0.74	8.88	0.48
S6-43-8	2	140	16	1.13	18.9	1.01
S6-54-8	2	111	16	1.45	23.9	0.90
S8-43-4	2	186	6	1.21	14.5	0.48
S8-54-4	2	148	6	1.58	18.9	0.41
S8-43-6	2	186	9	1.13	13.6	0.45
S8-54-6	2	148	9	1.18	14.2	0.31
S8-43-8	3	186	12	1.41	23.2	0.75
S8-54-8	2	148	12	1.81	29.9	0.69
S10-33-4	3	303	4.8	1.15	13.8	0.46
S10-54-4	2	185	4.8	1.84	22.1	0.32
S10-54-6	2	185	7.2	1.81	21.7	0.32
S10-43-8	2	233	9.6	1.62	27.0	0.59

Metric Conversion: 1 kip*in. = 0.112 kN*m, 1 kip = 4.448 kN

Average M_{tu}/M_{ng} ratios ranged from 0.31 to 1.01, with a mean value of 0.56 based on all the single L-header assemblies tested under uplift loads. The M_{tu}/M_{ng} ratios were found to generally increase as the span-to-vertical depth ratio of the assemblies increased. Complete results for single L-header assemblies under uplift loads are contained in Table B14 in Appendix B.

3.3.3 Single L-headers vs. Double L-headers

Comparing the flexural strength of single L-headers to that of an equivalent sized double L-header, the single L-header assemblies have larger M_{tu}/M_{ng} ratios. Further analyses showed the capacity of the single L-headers were consistently greater than half that of the equivalent double L-header assembly. As with gravity loads the actual capacity is to some degree influenced by the top and bottom track sections; however, under uplift loads it is presumed the track sections influence the performance of the assembly to a larger degree. Therefore, adding a second L-shaped section to the assembly only increases the capacity by some fraction, typically ranging between 1.50 and 1.90.

3.4 SHEAR INFLUENCE ON STRENGTH

The AISI – Header Design Standard (AISII, 2007) provisions provide a simplified conservative design approach which is based solely on the flexural performance of the L-header assemblies. However, based on the observed failure modes, buckling failure from purely flexural stresses did not occur. Rather it was apparent a combination of flexure and shear stresses influence the behavior of the L-header assemblies under uplift. Failure from flexural stresses alone would typically occur at mid-span where the flexural stresses are the highest; although, consistently buckling failure occurred elsewhere. As a result, the shear capacities of the assemblies were checked.

The nominal shear strength (V_n) for each assembly was computed based on Eq. (3.2) as per the *North American Specification for the Design of Cold-Formed Steel Structural Members*, Section C3.2 (CSA, 2007).

$$V_n = A_w F_v \tag{3.2}$$

Where A_w is the area of the web element and F_v is the nominal shear stress. The nominal shear stress for web sections having large slenderness ratios is typically governed by elastic shear buckling as (AISI, 2001b),

$$F_v = 0.904E t_w / (h/t)^2 \quad (3.3)$$

Where E is the elastic modulus of steel, h is the vertical depth of the L-shape section, t is the thickness of the L-shape section, and k_v is the shear buckling coefficient. Presuming the cripple studs are adequately attached to the webs of the L-section(s), the cripple studs would act as transverse web stiffeners. With transverse web stiffeners, the shear buckling coefficient was determined using Eq. (3.4). Where the shear panel length ‘ a ’ was taken as the distance between the cripple studs and/or king studs.

$$k_v = 5.34 + \frac{4.00}{(a/h)^2} \quad (3.4)$$

Comparing the ultimate shear force from the uplift tests (V_{tu}) to the nominal shear resistance (V_n), the nominal shear resistance was never exceeded during testing. Results indicate that typically the ultimate shear force experienced by the L-header assemblies was 1/3 that of the nominal shear strength. Although, a few short assemblies had V_{tu}/V_n ratios of as high as 0.74. Consequently, it could not be concluded that either shear or flexure alone caused failure, it is presumed a combination of shear stresses and flexural stresses play a significant role in the buckling failure the L-headers under uplift loads.

A combined bending and shear check was also performed at the critical section, where the buckling failure was found to occur for each tested assembly. Equation (3.5) was used to check the combined failure mode (CSA, 2007).

$$0.6 \frac{M_{tu}}{M_{ng}} + \frac{V_{tu}}{V_n} \leq 1.3 \quad (3.5)$$

With basing the nominal flexural strength on the gravity section properties the combined failure mode was never exceeded. In reality the actual nominal uplift flexural strength is less than the nominal gravity flexural strength, but to what degree is uncertain. Consequently,

without knowing exactly what the nominal flexural uplift strength is, basing the check on the nominal flexural gravity strength is particularly conservative and perhaps irrelevant. Complete results and comparisons are included in Tables B15 and B16 of Appendix B.

3.5 PROPOSED FLEXURAL STRENGTH DESIGN EQUATION

Currently the AISI - Header Design Standard (AISI, 2007) only provides design provisions for double L-headers under uplift loads. Based on the uplift test results the AISI – Header Design Standard (AISI, 2007) provisions significantly underestimate the strength of L-header assemblies; therefore, further improvements to the current double L-header design provisions are desirable.

Comparing the tested flexural strength (M_{tu}) to the nominal gravity flexural strength (M_{ng}) results show a general trend exists between the span-to-depth ratio and the M_{tu}/M_{ng} ratio for single and double L-header assemblies with span-to-depth ratios of 7.2 or greater. For assemblies with a span-to-depth ratio of less than 7.2 results indicate the span-to-depth ratio does not correlate well with the strength. Consequently, two new flexural strength design equations have been developed, one for assemblies that have a span-to-depth ratio greater than 7.2 and one for assemblies with span-to-depth ratios of less than 7.2. In an effort to stay consistent with the current design provisions the proposed design provisions are based solely on the flexural strength of the L-shaped section(s). A modification factor is applied to the flexural resistance to account for the reduced section properties due to uplift and the influence of shear effects. For assemblies with span to depth ratios of less than 7.2 a constant modification factor is applied to the flexural strength. While for assemblies with span-to-depth ratios of 7.2 or greater, the flexural strength is modified by a factor based on the span-to-depth ratio.

With the use of Statistical Analysis System (SAS, 2004) software, the span-to-depth ratio was found to linearly correlate with the M_{tu}/M_{ng} ratio. Therefore, the proposed nominal strength (M_{nu}) determination equation takes the general form as shown in Eq. (3.6) or (3.7) for assemblies with a span-to-depth of 7.2 or higher. For assemblies with span-to-vertical depth ratios of less than 7.2, Eq. (3.8) shall be used.

For double L-headers: $L/h \geq 7.2$

$$M_{nu} = S_{ec} F_y \left(0.025 + 0.065 \left(\frac{L}{h} \right)^{0.8} \right) \quad (3.6)$$

for single L-headers: $L/h \geq 7.2$

$$M_{nu} = S_{ec} F_y \left(-0.140 + 0.065 \left(\frac{L}{h} \right)^{1.0} \right) \quad (3.7)$$

and for double & single L-headers: $L/h < 7.2$

$$M_{nu} = 0.95 S_{ec} F_y \quad (3.8)$$

Where S_{ec} is the effective section modulus computed at ($f = F_y$) of the extreme compression flange based on gravity loads, F_y is the yield strength, L is the span length, h is the vertical depth of the L-shape, and t is the thickness. The numerical coefficients were determined using the SAS software. The coefficients for double L-header assemblies were based on 37 tests with L/h ratios of 7.2 or greater. The single L-header coefficients were determined based on 23 tests.

Summarized in Tables B17 and B18 in Appendix B are the ultimate test moment (M_{tu}) and predicted nominal uplift flexural strength (M_{nu}) for both double and single L-header assemblies, respectively. The relationship between M_{tu} and M_{nu} is shown graphically in Figure 3.7 and Figure 3.8 for double and single L-header assemblies, respectively. The solid line on the plots represents an ideal solution of M_{tu} equal to M_{nu} . Data points below the solid line indicate an overestimation of the flexural strength, while points above the line indicate an underestimation of the flexural strength. The region bound by the dashed lines represents the points which fall within 20% of the ideal solution.

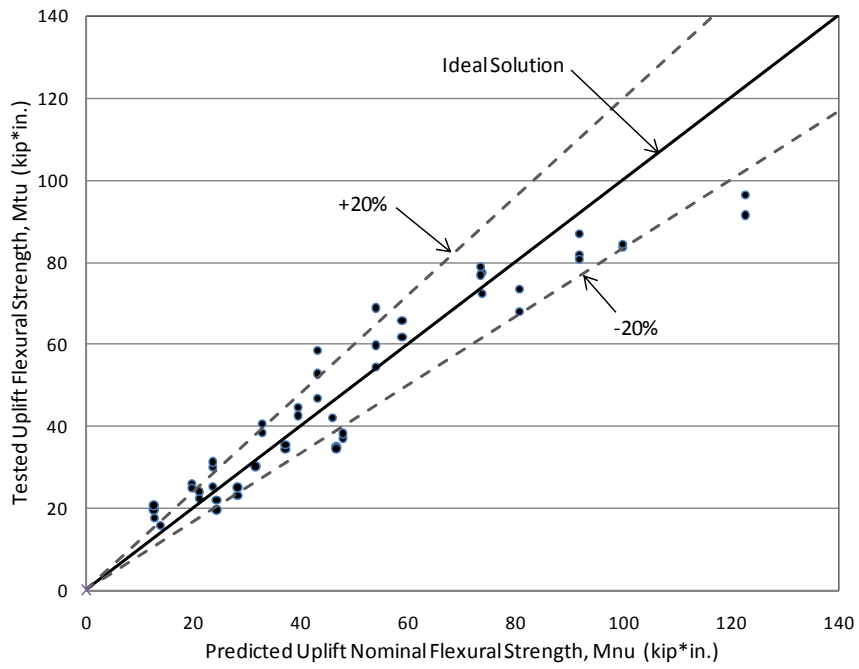

Figure 3.7 Uplift Load Case - M_{tu} Compared to M_{nu} for Double L-headers

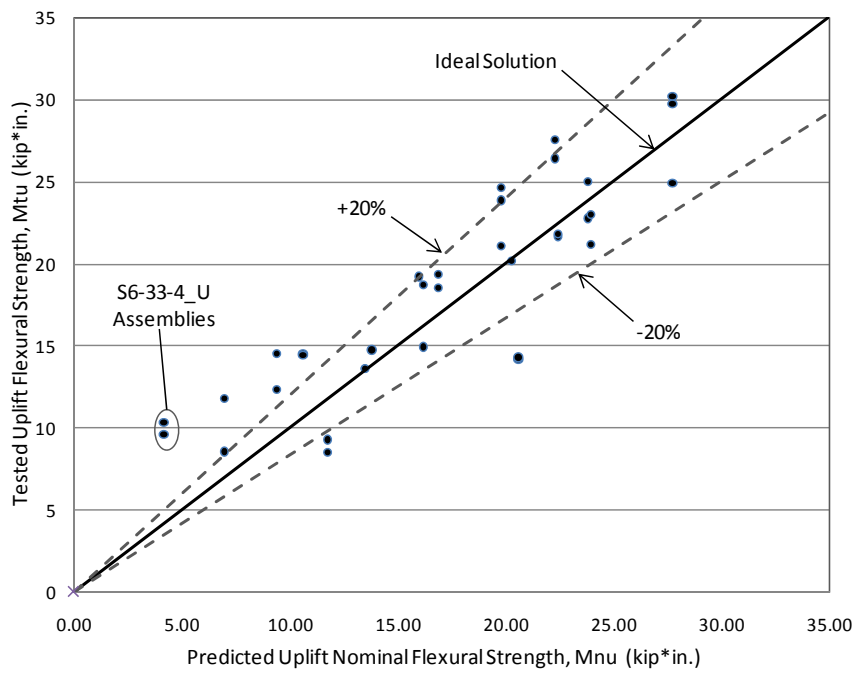

Figure 3.8 Uplift Load Case - M_{tu} Compared to M_{nu} for Single L-headers

For the double L-headers the average M_{tg}/M_{ng} ratio was determined to be 1.036, with a standard deviation of 0.209, and a coefficient of variation of 0.202. For single L-headers the average M_{tg}/M_{ng} ratio was determined to be 1.082, with a standard deviation of 0.224, and a coefficient of variation of 0.207. The statistical data was used to determine the values of Ω (ASD factor of safety) and ϕ (LRFD resistance factor) according to Section F1 of the AISI North American Specification (CSA, 2007). With using a calibration program written by Baher Beshara (Beshara, 2005), the Ω and ϕ factors determined are summarized in Table 3.3 Uplift Load Case - Values of Ω and ϕ .

Table 3.3 Uplift Load Case - Values of Ω and ϕ

Configuration	Ω (ASD factor of safety)	ϕ (LRFD resistance factor)
Double L-header	1.95	0.652
Single L-header	1.90	0.665

3.6 DEFLECTION – SERVICEABILITY LIMIT STATE

In an effort to further understand the behavior of L-headers under uplift loads, vertical deflections were recorded for all test assemblies. Previous research studies conducted at the NAHB Research Center on single and double L-headers did not incorporate detailed vertical deflection records. As a result, the current AISI - Header Standard does not provide any guidance with regards to span deflection computations. Based on the analysis of the vertical deflection data a design expression to predict the span deflections of L-header assemblies under uplifts is developed.

Generally, headers are designed to meet a minimum deflection criterion of $L/240$ under service loads. The mid-span deflection for each tested L-header assembly was compared to the $L/240$ limit at an applied load equal to the service load level. Sixty percent of the ultimate load was used as the service load level. Test results indicate mid-span deflections at service loads were typically less than $L/240$, as summarized in Table 3.4 and Table 3.5 for double and single L-header assemblies, respectively. Complete deflection results for each test assembly are included in Tables B19 and B20 of Appendix B.

Deflection results were also compared to a predicted mid-span deflection based on simply supported flexural deformation equations, as previously presented 3ft (0.91m) & 4ft (1.22m)

assemblies – Eq. (2.10), 6ft (1.83m) assemblies – Eq. (2.11), 8ft (2.44m) assemblies – Eq. (2.13), 12ft (3.66m) assemblies – Eq. (2.14), and 16ft (4.88m) assemblies – Eq. (2.15). Where the effective moment of inertia I_{ec} is computed at $f = F_y$ and based on gravity loads. Using a constant effective moment of inertia a linear load-deflection curve is produced.

Table 3.4 Uplift Load Case - Double L-header Deflection Summary

Assembly Designation	No. of Tests	Average Ultimate Load, P_t (kip)	Load at $L/240$ (kip)	$L/240$ (in.)	Deflection at Service Load Level (in.)
D6-43-3_U	2	1.84	1.27	0.15	0.13
D6-54-3_U	2	2.83	2.02		0.11
D8-33-3_U	2	2.24	1.64		0.10
D8-43-3_U	2	2.57	1.77		0.11
D10-43-3_U	2	3.35	2.29		0.12
D10-54-3_U	2	4.17	2.60		0.14
D6-54-6_U	2	2.00	1.52	0.30	0.19
D8-43-6_U	2	1.73	1.52		0.14
D8-54-6_U	2	2.91	2.28		0.17
D10-54-6_U	2	2.89	2.13		0.19
D6-43-8_U	3	1.79	1.09	0.40	0.40
D6-54-8_U	2	2.41	1.35		0.45
D8-54-8_U	2	3.44	2.02		0.42
D10-43-8_U	2	2.76	2.19		0.21
D10-54-8_U	3	3.75	2.55		0.30
D8-54-12_U	2	2.87	1.74	0.60	0.58
D8-68-12_U	2	3.19	1.96		0.57
D10-54-12_U	2	3.53	2.38		0.46
D10-68-12_U	2	3.82	2.70		0.43
D8-54-16_U	2	2.67	1.55	0.80	0.84
D10-54-16_U	3	2.97	1.98		0.62
D10-68-16_U	2	3.36	2.28		0.63

Metric Conversion: 1 kip = 4.448 kN, 1 in. = 25.4 mm

Table 3.5 Uplift Load Case - Single L-header Deflection Summary

Assembly Designation	No. of Tests	Average Ultimate Load, P_t (kip)	Load at $L/240$ (kip)	$L/240$ (in.)	Deflection at Service Load Level (in.)
S6-33-4_U	2	0.83	0.56	0.20	0.16
S6-43-4_U	2	0.84	0.55		0.18
S8-43-4_U	2	1.21	0.84		0.15
S8-54-4_U	3	1.47	0.95		0.17
S10-33-4_U	3	1.15	0.75		0.17
S10-54-4_U	2	1.84	1.28		0.15
S6-43-6_U	2	0.74	0.60	0.30	0.16
S8-43-6_U	2	1.13	0.92		0.13
S8-54-6_U	3	1.18	0.91		0.18
S10-54-6_U	2	1.81	1.45		0.14
S6-43-8_U	2	1.15	0.66	0.40	0.44
S6-54-8_U	2	1.45	0.73		0.55
S8-43-8_U	3	1.41	0.88		0.36
S8-54-8_U	2	1.81	1.06		0.42
S10-43-8_U	2	1.63	1.18		0.27

Metric Conversion: 1 kip = 4.448 kN, 1 in. = 25.4 mm

Load-deflection plots of the test data were produced and compared to the predicted linear load-deflection curves. Generally the load-deflection curves for the L-header assemblies were non-linear throughout the full range of loading. However, once the load increased beyond about the service load level, the curves tend to become increasingly non-linear. Consistently, the predicted load-deflection curve was found to be stiffer than the L-header assemblies and thus smaller deflections were predicted. Ideally the predicted simply supported flexural model would pass through the actual load-deflection curves at the service load level. For the short L-header assemblies the difference between the predicted and actual stiffness was the most significant (Figure 3.9), the longer spans correlated fairly well with the predicted stiffness (Figure 3.10).

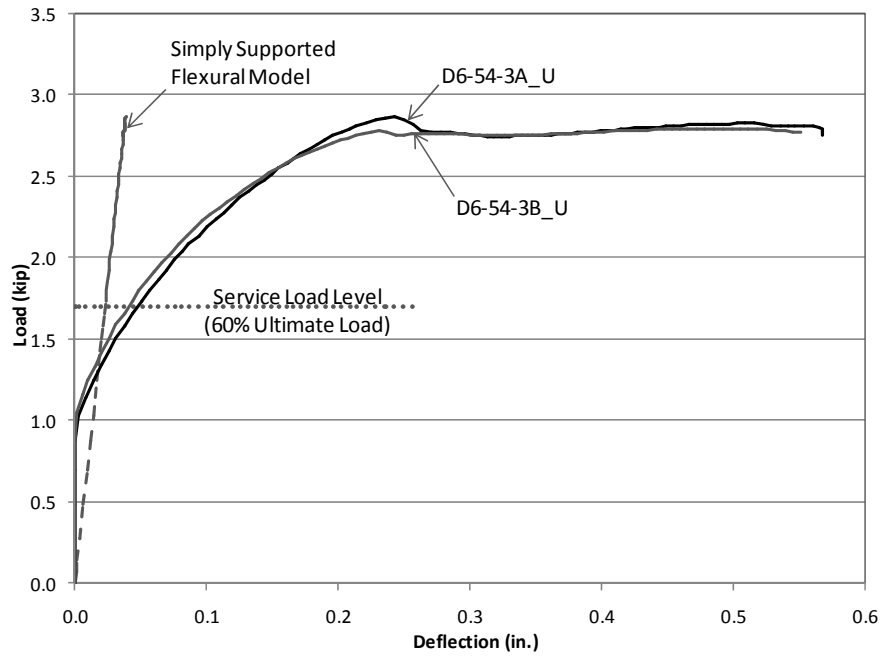

Figure 3.9 Uplift Load Case - Typical Short Span Load-Deflection Curve

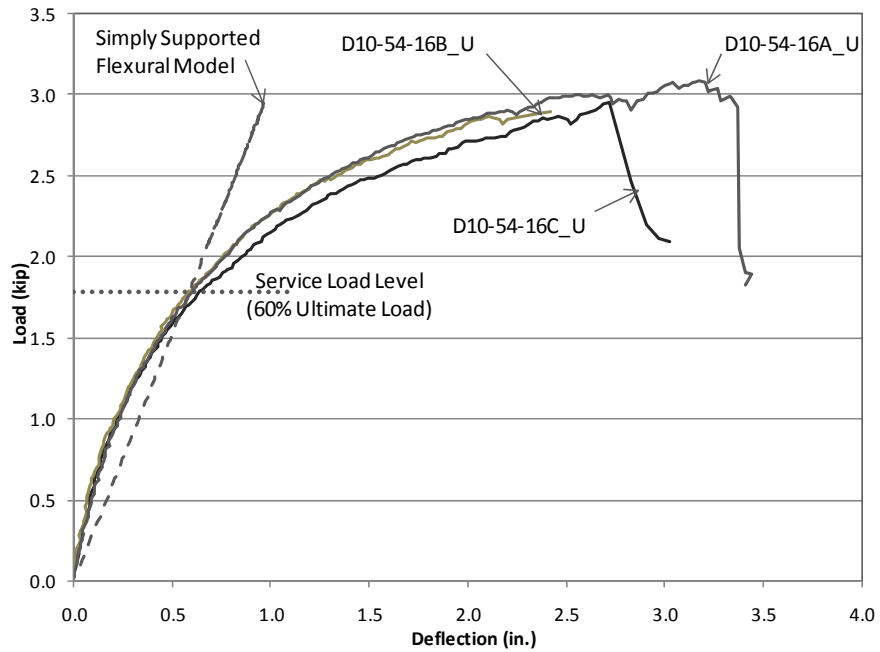

Figure 3.10 Uplift Load Case - Typical Long Span Load-Deflection Curve

3.7 PROPOSED DEFLECTION PREDICTION EQUATIONS

When subjected to uplift loads L-headers can experience significant deformation, due to the stiffness reduction associated with local buckling. As previously discussed, the L-headers typically met the $L/240$ criterion; however, their stiffness was less than predicted by simply supported flexural equations. In order to rationally compare the difference between the predicted stiffness with the actual stiffness at the service load level, an equivalent moment of inertia (I_{eq}) was computed at which the predicted deflection equaled the actual deflection at the service load level. The ratio of the equivalent effective moment of inertia I_{eq} to the actual effective moment of inertia I_{ec} was used to give an indication of how much the effective moment of inertia needs to be modified. Results are summarized in Table 3.6 and Table 3.7 for double and single L-header assemblies, respectively.

Table 3.6 Uplift Load Case - Double L-header I_{eq}/I_{ec} Deflection Summary

Assembly Designation	No. of Tests	L/h	h/t	Average I_{eq}/I_{ec}
D6-43-3_U	2	6	140	0.15
D6-54-3_U	2	6	111	0.19
D8-33-3_U	2	4.5	242	0.12
D8-43-3_U	2	4.5	186	0.10
D10-43-3_U	2	3.6	233	0.07
D10-54-3_U	2	3.6	185	0.05
D6-54-6_U	2	12	111	0.55
D8-43-6_U	2	9	186	0.37
D8-54-6_U	2	9	148	0.39
D10-54-6_U	2	7.2	185	0.18
D6-43-8_U	3	16	140	0.67
D6-54-8_U	2	16	111	0.62
D8-54-8_U	2	12	148	0.42
D10-43-8_U	2	9.6	233	0.45
D10-54-8_U	3	9.6	185	0.35
D8-54-12_U	2	18	148	0.81
D8-68-12_U	2	18	118	0.68
D10-54-12_U	2	14.4	185	0.66
D10-68-12_U	2	14.4	147	0.57
D8-54-16_U	2	24	148	1.17
D10-54-16_U	3	19.2	185	0.94
D10-68-16_U	2	19.2	147	0.79

Further analysis of the I_{eq}/I_{ec} ratios showed that there is a direct correlation between the span-to-depth ratio and the I_{eq}/I_{ec} ratio. As a result, a deflection prediction equation was

developed based solely on the flexural deformations, which uses a modification factor to convert the effective moment of inertia into an equivalent effective moment of inertia. The equations previously presented for simply supported flexural deformations are used to predict the deflection; although, I_{ec} is replaced with I_{eq} . The equivalent moment of inertia has been calibrated to make the predicted load-deflection curve pass through the actual load deflection curve at the service load level (60% of ultimate load).

Table 3.7 Uplift Load Case - Single L-header I_{eq}/I_{ec} Deflection Summary

Assembly Designation	No. of Tests	L/h	h/t	Average I_{eq}/I_{ec}
S6-33-4_U	2	8	182	0.14
S6-43-4_U	2	8	140	0.11
S8-43-4_U	2	6	186	0.09
S8-54-4_U	3	6	148	0.07
S10-33-4_U	3	4.8	303	0.05
S10-54-4_U	2	4.8	185	0.05
S6-43-6_U	2	12	140	0.64
S8-43-6_U	2	9	186	0.51
S8-54-6_U	2	9	148	0.30
S10-54-6_U	2	7.2	185	0.32
S6-43-8_U	2	16	140	0.77
S6-54-8_U	2	16	111	0.61
S8-43-8_U	3	12	186	0.51
S8-54-8_U	2	12	148	0.44
S10-43-8_U	2	9.6	233	0.42

Equations (3.9) and (3.10) are used to convert the effective moment of inertia into the equivalent moment of inertia for double and single L-headers, respectively. The equation for double L-header assemblies was based on the 47 test results that are summarized in Table 3.6, while the single L-header equation was based on the 33 test results that are summarized in Table 3.7.

For double L-headers:

$$I_{eq} = [0.05(L/h) - 0.13] I_{ec} \quad (3.9)$$

and for single L-headers:

$$I_{eq} = [0.06(L/h) - 0.20] I_{ec} \quad (3.10)$$

Where L is the span length of the assembly, h is the vertical depth of the L-shape(s), and I_{ec} is the effective moment of inertia calculated at ($f = F_y$) based on gravity loads.

Provided in Tables B21 and B22 of Appendix B are complete comparisons of the measured (Δ_{tu}) and predicted (Δ_u) deflection at the service load level, for double and single L-headers respectively. The relationship of Δ_{tu}/Δ_u is shown graphically in Figure 3.11 and Figure 3.12.

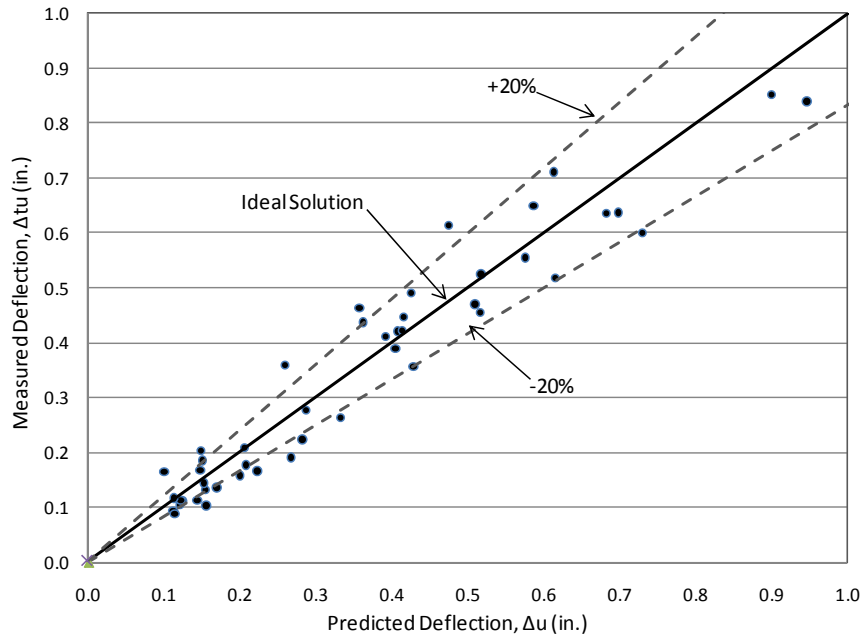

Figure 3.11 Uplift Load Case - Comparison of Δ_{tu} to Δ_u for Double L-headers

The solid line on the plots represents an ideal solution of the test deflection equaling the predicted deflection. Data points below the solid line indicate an overestimation of the deflection, while points above the line indicate an underestimation of the deflection. The region bound by the dashed lines represents the points which fall within 20% of the ideal solution. The average Δ_{tu}/Δ_u ratio for the double L-header data set was 0.97, while this is a favorable average the standard deviation of the data set was 0.20.

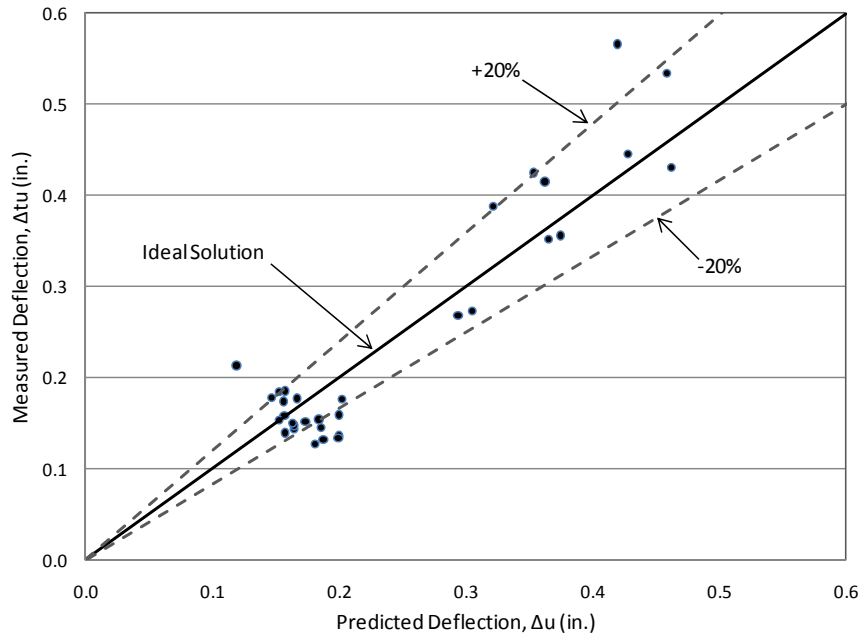

Figure 3.12 Uplift Load Case - Comparison of Δ_{tu} to Δ_u for Single L-headers

For the single L-header data set the average is 0.99, with a standard deviation of 0.23. The high standard deviations indicate the results vary considerably. Furthermore, since design for serviceability does not involve factors of safety or resistance factors, a more conservative prediction of the equivalent moment of inertia is proposed. It is proposed Eqs. (3.9) and (3.10) are multiplied by 0.85 to account for some of the variation in the results. Equations (3.11) and (3.12) produce more conservative equivalent effective moments of inertia, thus larger predicted deflections.

For double L-headers:

$$I_{eq} = 0.85 \left[0.05 \left(\frac{L}{h} \right) - 0.13 \right] I_{ec} \quad (3.11)$$

and for single L-headers:

$$I_{eq} = 0.85 \left[0.06 \left(\frac{L}{h} \right) - 0.20 \right] I_{ec} \quad (3.12)$$

As a result, of predicting conservative deflections it becomes apparent that the $L/240$ deflection criterion is no longer met for all assemblies at the service load level. Consequently, the design of L-header assemblies under uplift loads may perhaps be governed by the serviceability limit state rather than the ultimate limit state for certain L-headers.

3.8 EFFECT OF GYPSUM BOARD ON L-HEADERS

Two identical S6-54-6 assemblies were constructed and one sheet of ½ in. (12.7mm) gypsum board was applied to one side. The results of the assembly tests with and without gypsum board under uplift loads are compared in Table 3.8. Graphically the tests are compared with a load-deflection curve, as shown in Figure 2.17.

Table 3.8 Uplift Load Case - Gypsum Board Test Results

Assembly Designation	Gypsum Board	Ultimate Load P_t (kip)	Maximum Test Moment M_{tu} (kip*in.)	Defl. @ Service Load Level (in.)
S6-54-8A_U	Yes	1.81	29.5	0.28
S6-54-8B_U	Yes	1.90	30.4	0.32
S6-54-8A_U	No	1.51	25.2	0.58
S6-54-8B_U	No	1.39	22.7	0.53

Metric Conversion: 1 kip = 4.448 kN, 1 kip*in. = 0.112 kN*m, 1 in. = 25.4 mm

It becomes apparent that under uplift loads the gypsum board can improve the flexural performance of the L-header assemblies. The stiffness of the assembly is increased, which results in less deflection under service loads. Also, the flexural strength is increased. It was observed that the gypsum board cracked / failed at the same point the L-header assembly failed. Although, it appears that the gypsum board can significantly improve the structural performance of L-headers under uplift loads. Further tests would need to be conducted on a wider range of L-header assemblies to make any general conclusions.

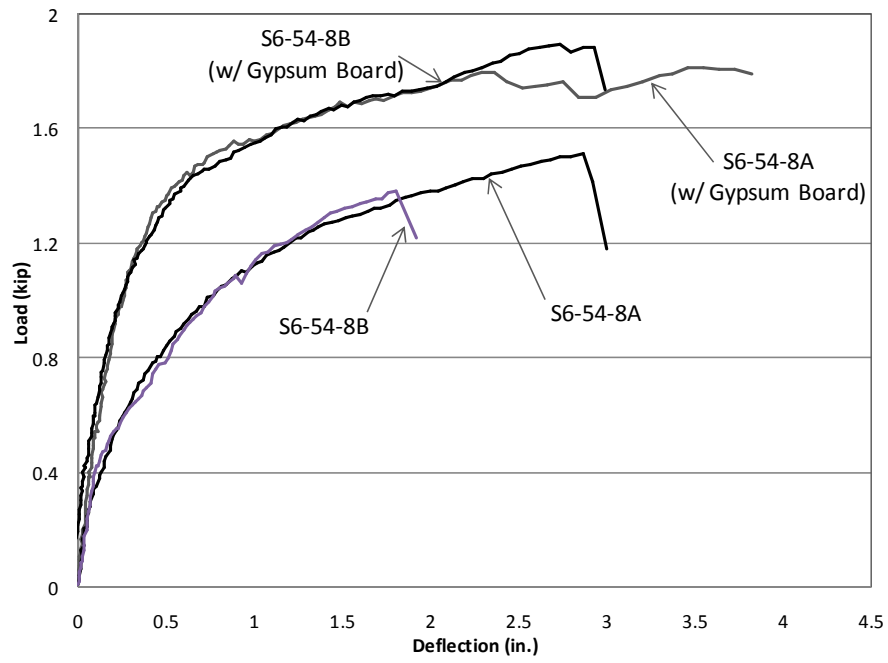

Figure 3.13 Uplift Load Case - Drywall Comparison Load-Deflection Curve

Chapter 4

CONCLUSIONS

Based on a total of 188 tests conducted, new flexural strength equations have been proposed for both double and single L-headers. The proposed flexural strength equations provide an improved approximation of the actual flexural strength of the L-header assemblies, compared to the current AISI – Header Design Standard (AISI, 2007) provisions. Under gravity loads the proposed equations take into account the effects web-crippling and shear in short span assemblies and the inherit connection stiffness of long span assemblies. In the case of uplift loads the proposed flexural strength equations account for both the effects of shear and the reduced section properties associated with local buckling.

A new formulation to predict vertical deflections of single and double L-header under gravity and uplift loads has also been proposed. The proposed formulations use general simply supported flexural deformation equations, with an equivalent effective moment of inertia term.

Based on the test results and analysis, the following conclusions of the flexural strength and structural behavior of cold-formed steel L-headers were observed:

1. Gravity Load Case

- Failure of single and double L-header assemblies was observed to be either a combination of flexure and web-crippling or purely flexural. Short span assemblies showed signs of web-crippling as well as shear; however, assemblies longer than 6ft (1.83m) were observed to fail purely in flexure.
- The behavior of short span assemblies is influenced by web-crippling, shear, and flexure. The current AISI – Header Design Standard (AISI, 2007) bases the nominal resistance of the assemblies on flexure alone; therefore, the nominal flexural resistance of short span assemblies is over-estimated.
- Flexural failure is increasingly predominant in long span assemblies. For such assemblies the nominal flexural resistance calculated as per the AISI - Header Design Standard (AISI, 2007) results in accurate or underestimated resistance values. For spans of 8ft (2.44m) or greater, it became evident that the connections

between the L-sections and the king studs provide an inherent stiffness; therefore, acting as semi-rigid connections rather than pinned end connections.

- Flexure, shear, and localized web-crippling deformations play a significant role in the total deflection of short span assemblies. Assemblies larger than 6ft (1.83m) act as semi-rigid members. Depending on the assemblies fixity factor the mid-span deflection can be considerably less than predicted by common simply supported flexural deformation equations.
- With Gypsum board applied to the assemblies, little effect on the strength was noticed for stiff L-header assemblies; however, for assemblies with lower stiffness' the gypsum board appears to influence the strength considerably.

2. Uplift Load Case

- Failure of single and double L-header assemblies was observed to be due to a combination of flexural and shear. The unsupported webs showed signs of local buckling immediately after loading commenced, which causes the strength and stiffness to be significantly decreased.
- The new effective width formulation for unstiffened compression elements subjected to stress gradient (Section B3.2 2(ii); CSA, 2007) is not practical for L-headers under uplift loads. The new formulation produces effective section properties which are excessively small, instead it is recommend the section properties based on gravity loads be used for the uplift load case as well.
- Using the current AISI – Header Design Standard (AISII, 2007) to calculate nominal flexural resistances of double L-headers produces exceptionally conservative results.
- L-headers typically met the $L/240$ deflection criterion under service loads; however, their mid-span deflections were generally greater than predicted by common simply supported flexural deformation equations.
- Gypsum board can improve the flexural performance of the L-header assemblies. The stiffness of the assembly is increased, resulting in lower deflections under service loads. The flexural strength is also increased.

4.1 RECOMMENDATIONS FOR FUTURE RESEARCH

Based on the findings of this investigation, the following recommendations for future research are proposed:

1. Additional experimental work should be carried out on 3ft (0.91m) and 4ft (1.22m) short span assemblies to develop accurate span deflection expressions. The short span assemblies meet the $L/240$ deflection criterion; however, due to inadequate testing a deflection expression for short span assemblies could not be developed.
2. Verify the proposed design provisions for both single and double L-headers with the use of 6-inch deep studs and track sections.
3. Additional testing is required to quantify the effect gypsum board has on the overall strength when applied to L-header assemblies. This study provided an indication that gypsum board can significantly increase the stiffness of assemblies with low section properties and sections loaded under uplift. However, only limited testing was conducted.
4. Further testing is required under uplift loads to successfully understand the combined failure behavior.
5. Further analysis should be carried out to quantify the effect the track sections have on the overall assemblies' strength. As indicated in this investigation the flexural strength of the L-header assembly is to some degree affected by the track sections.
6. Development of a finite element analysis program to efficiently model the structural behavior and strength of L-header assemblies.

BIBLIOGRAPHY

AISI. (2001b). *Commentary on North American Specification for the Design of Cold-Formed Steel Structural Members, 2001 Edition*. Washington, D.C.: American Iron and Steel Institute.

AISI. (2001a). *North American Specification for the Design of Cold-Formed Steel Structural Members*. Washington, D.C.: American Iron and Steel Institute.

AISI. (2007). *North American Standard for Cold-Formed Steel Framing - Header Design AISI S212-07*. Washington, D.C.: American Iron and Steel Institute.

ASTM. (2003). *Standard Test Methods and Definitions for Mechanical Testing of Steel Products (A370) & (A90)*. West Conshohocken, P.A.: American Society for Testing and Materials.

Beshara, B. (2005). *Calibration Program for Cold Formed Steel Members. Version 2.1*. University of Waterloo, Ontario, Canada.

CSA. (2007). *North American Specification for the Design of Cold-Formed Steel Structural Members S136-07 (AISI S100)*. Mississauga, Ontario: Canadian Standards Association.

Elhajj, N. R., & LaBoube, R. A. (2000). L-Header Testing, Evaluation and Design Methodology. *Proceedings of the 15th International Specialty Conference on Cold-Formed Steel Structures*, (pp. 437-456). Department of Civil Engineering University of Missouri-Rolla, Rolla, MO.

LaBoube, R. (2005). *L-Header Testing, Evaluation and Design Methodology*. Report submitted to AISI Cold-Formed Steel Framing Committee.

NAHB-RC. (1997). *Cold-Formed Steel Back-to-Back Header Assembly Tests (Publication RG-9719)*. Washington, D.C.: American Iron and Steel Institute.

NAHB-RC. (1998). *L-Shaped Header Testing, Evaluation, and Design Guidance*. Upper Marlboro, M.D.: National Association of Home Builders Research Center.

NAHB-RC. (2003). *Testing of Steel Single L-Headers*. Upper Marlboro, MD: National Association of Home Builders Research Center.

SAS. (2004). *Statistical Analysis System 9.1.3*. Cary, NC, USA: SAS Institute Inc.

Xu, L. (2001). Second-order Analysis for Semirigid Steel Frame Design. *Canadian Journal of Civil Engineering*, Vol. 28 , 59-76.

Appendix A
ASSEMBLY PROPERTIES

TABLE A1 - Mechanical Properties - Gravity Tests

	Material Designation¹	Uncoated Thickness (in.)	Yield Strength (ksi)	Tensile Strength (ksi)	Average Elongation (%)
3' / 4' / 6' Spans	600L150-33	0.0334	51.8	55.7	33.7%
	600L150-43	0.0437	54.5	59.5	29.4%
	600L150-54	0.0541	58.5	78.0	30.1%
	800L150-33	0.0341	58.5	67.2	28.2%
	800L150-43	0.0434	51.2	61.4	30.3%
	800L150-54	0.0541	58.5	78.0	30.1%
	1000L150-33	0.0341	58.5	67.2	28.2%
	1000L150-43	0.0434	51.2	61.4	30.3%
	1000L150-54	0.0541	58.5	78.0	30.1%
8' / 12' Spans	600L150-43	0.0438	50.4	55.4	30.8%
	600L150-54	0.0543	55.0	71.2	31.1%
	800L150-43	0.0438	50.4	55.4	30.8%
	800L150-54	0.0543	55.0	71.2	31.1%
	800L150-68	0.0695	55.6	72.7	30.8%
	1000L150-43	0.0438	50.4	55.4	30.8%
	1000L150-54	0.0543	55.0	71.2	31.1%
	1000L150-68	0.0695	55.6	72.7	30.8%
16' Span	800L150-54	0.0542	55.7	72.0	30.2%
	800L150-68	0.0698	55.8	73.5	29.8%
	1000L150-54	0.0542	55.7	72.0	30.2%
	1000L150-68	0.0698	55.8	73.5	29.8%

Metric Conversion: 1 in. = 25.4 mm, 1 ksi = 6,895 kPa

¹ Material designation is as per the Steel Stud Manufacturers Association (SSMA). For example an 800L150-43 designation refers to an L-shaped angle with an 8" long leg (1/100 inches), 1.5" short leg (1/100 inches) and a 43 mil nominal thickness.

TABLE A2 - Mechanical Properties - Uplift Tests

	Material Designation¹	Uncoated Thickness (in.)	Yield Strength (ksi)	Tensile Strength (ksi)	Average Elongation (%)
3' / 4' / 6' Spans	600L150-33	0.038	34.0	52.9	30.7
	600L150-43	0.043	50.2	55.0	32.6
	600L150-54	0.056	56.7	63.9	31.9
	800L150-33	0.038	34.0	52.9	30.7
	800L150-43	0.043	50.2	55.0	32.6
	800L150-54	0.056	56.7	63.9	31.9
	1000L150-33	0.038	34.0	52.9	30.7
	1000L150-43	0.043	50.2	55.0	32.6
	1000L150-54	0.056	56.7	63.9	31.9
8' / 12' Spans	600L150-43	0.044	52.0	55.9	31.1
	600L150-54	0.054	55.1	75.8	28.4
	800L150-43	0.044	52.0	55.9	31.1
	800L150-54	0.054	55.1	75.8	28.4
	800L150-68	0.070	55.1	76.2	29.4
	1000L150-43	0.044	52.0	55.9	31.1
	1000L150-54	0.054	55.1	75.8	28.4
	1000L150-68	0.070	55.1	76.2	29.4
16' Span	800L150-54	0.054	55.6	76.2	28.4
	800L150-68	0.070	54.7	73.9	29.8
	1000L150-54	0.054	55.6	76.2	28.4
	1000L150-68	0.070	54.7	73.9	29.8

Metric Conversion: 1 in. = 25.4 mm, 1 ksi = 6,895 kPa

¹ Material designation is as per the Steel Stud Manufacturers Association (SSMA). For example an 800L150-43 designation refers to an L-shaped angle with an 8" long leg (1/100 inches), 1.5" short leg (1/100 inches) and a 43 mil nominal thickness.

TABLE A3 - Section Properties (Gravity Tests)

	Material Designation¹	Gross Moment of Inertia, I_g (in.⁴)	Effective Moment of Inertia, I_{ec} (in.⁴)	Effective Section Modulus, S_{ec} (in.³)
3' / 4' / 6' Spans	600L150-33	0.94	0.74	0.27
	600L150-43	1.23	1.00	0.37
	600L150-54	1.51	1.28	0.48
	800L150-33	2.11	1.70	0.45
	800L150-43	2.67	2.25	0.61
	800L150-54	3.32	2.87	0.78
	1000L150-33	3.90	3.22	0.68
	1000L150-43	4.95	4.25	0.90
	1000L150-54	6.14	5.40	1.16
8' / 12' Spans	600L150-43	1.23	1.01	0.37
	600L150-54	1.52	1.29	0.48
	800L150-43	2.70	2.27	0.61
	800L150-54	3.33	2.89	0.79
	800L150-68	4.23	3.84	1.07
	1000L150-43	4.99	4.29	0.91
	1000L150-54	6.16	5.44	1.17
	1000L150-68	7.84	7.19	1.57
16' Span	800L150-54	3.32	2.88	0.79
	800L150-68	4.25	3.86	1.07
	1000L150-54	6.15	5.43	1.16
	1000L150-68	7.87	7.23	1.57

Metric Conversion: 1 in.⁴ = 416,231 mm⁴, 1 in.³ = 16,387 mm³

¹ Material designation is as per the Steel Stud Manufacturers Association (SSMA). For example an 800L150-43 designation refers to an L-shaped angle with an 8" long leg (1/100 inches), 1.5" short leg (1/100 inches) and a 43 mil nominal thickness.

TABLE A4 - Section Properties (Uplift Tests)

	Material Designation¹	Gross Moment of Inertia, I_g (in.⁴)	Effective Moment of Inertia, I_{ec} (in.⁴)	Effective Section Modulus, S_{ec} (in.³)
3' / 4' / 6' Spans	600L150-33	1.06	0.88	0.32
	600L150-43	1.22	1.00	0.37
	600L150-54	1.56	1.33	0.50
	800L150-33	2.33	1.97	0.53
	800L150-43	2.67	2.25	0.61
	800L150-54	3.43	2.99	0.82
	1000L150-33	4.31	3.71	0.79
	1000L150-43	4.93	4.24	0.90
	1000L150-54	6.35	5.62	1.21
8' / 12' Spans	600L150-43	1.22	1.00	0.37
	600L150-54	1.51	1.28	0.48
	800L150-43	2.68	2.25	0.61
	800L150-54	3.32	2.88	0.78
	800L150-68	4.25	3.87	1.07
	1000L150-43	4.96	4.25	0.90
	1000L150-54	6.14	5.42	1.16
	1000L150-68	7.88	7.24	1.58
16' Span	800L150-54	3.30	2.86	0.78
	800L150-68	4.23	3.85	1.07
	1000L150-54	6.10	5.38	1.15
	1000L150-68	7.84	7.20	1.57

Metric Conversion: 1 in.⁴ = 416,231 mm⁴, 1 in.³ = 16,387 mm³

¹ Material designation is as per the Steel Stud Manufacturers Association (SSMA). For example an 800L150-43 designation refers to an L-shaped angle with an 8" long leg (1/100 inches), 1.5" short leg (1/100 inches) and a 43 mil nominal thickness.

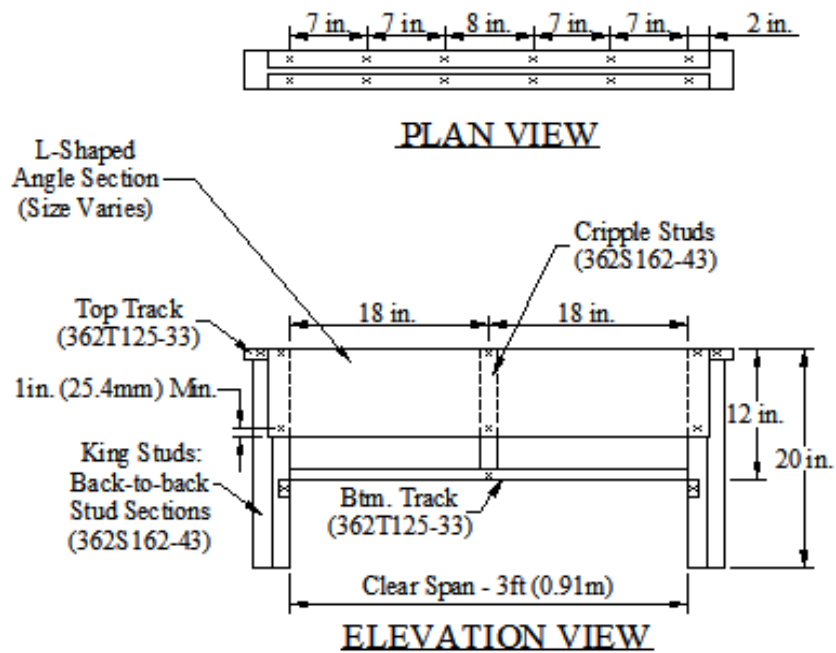

***NOTE: Screw Sizes**

Gravity Load Case:

No. 8 Self-drilling Screws (typical)

Uplift Load Case:

>54 mil (1.37mm) thickness - No. 8 self-drilling screws used throughout
 <54 mil (1.37mm) thickness - No. 10 self-drilling screws used to attach long leg of L-shape(s)
 to cripple studs and king studs. No. 8 self-drilling screws used
 elsewhere.

Metric Conversion:

1 in. = 25.4 mm

1 ft = .305 m

DWG. TITLE:

Typical 3ft (0.91m) Assembly

PROJECT:

Flexural Behavior and Strength of Cold-formed Steel L-headers

DATE:

July 2008

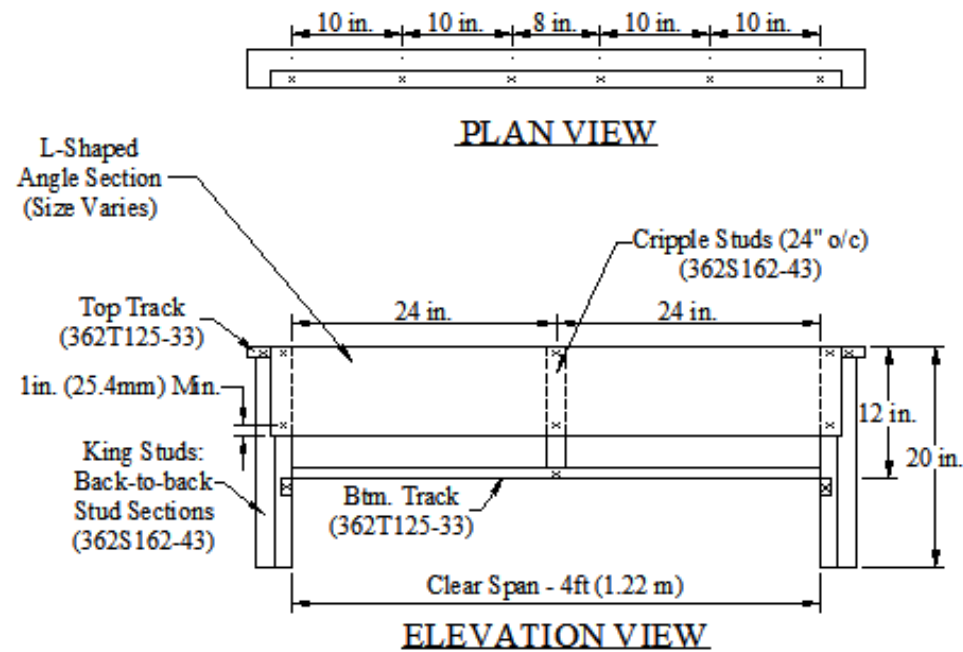

***NOTE: Screw Sizes**
Gravity Load Case:
 No. 8 Self-drilling Screws (typical)

Uplift Load Case:
 >54 mil (1.37mm) thickness - No. 8 self-drilling screws used throughout
 <54 mil (1.37mm) thickness - No. 10 self-drilling screws used to attach long leg of L-shape(s)
 to cripple studs and king studs. No. 8 self-drilling screws used elsewhere.

Metric Conversion:
 1 in. = 25.4 mm
 1 ft. = .305 m

DWG. TITLE:
 Typical 4ft (1.22m) Assembly

PROJECT:
 Flexural Behavior and Strength of Cold-formed Steel L-headers

DATE:
 July 2008

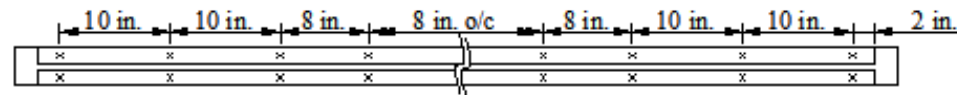

PLAN VIEW

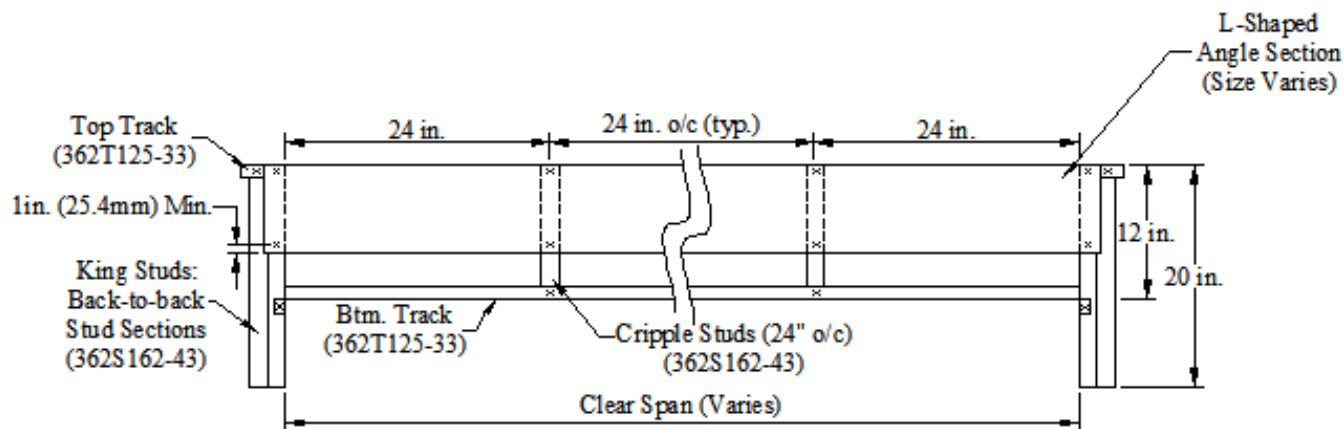

ELEVATION VIEW

***NOTE: Screw Sizes**

Gravity Load Case:

No. 8 Self-drilling Screws (typical)

Uplift Load Case:

>54 mil (1.37mm) thickness - No. 8 self-drilling screws used throughout

<54 mil (1.37mm) thickness - No. 10 self-drilling screws used to attach long leg of L-shape(s) to cripple studs and king studs. No. 8 self-drilling screws used elsewhere.

Metric Conversion:

1 in. = 25.4 mm

1 ft. = .305 m

DWG TITLE:
Typical 6ft (1.83m) to 16ft (4.88m) Assembly

PROJECT:
Flexural Behavior and Strength of Cold-formed Steel L-headers

DATE:
July 2008

Appendix B
TEST DATA

TABLE B1 – Double L-header Strength Test Data (Gravity Loads)

Header Designation ¹	Span <i>L</i> (ft.)	<i>L/h</i>	<i>h/t</i>	Ultimate Test Load <i>P_t</i> (kip)	Test Moment <i>M_{tg}</i> (kip*in.)	AISI – N.A. Specification (AISI S100-07)		AISI – Header Standard (AISI S212-07)	
						<i>M_{ng}</i> (kip*in.)	<i>M_{tg} / M_{ng}</i>	<i>M_{ng}</i> (kip*in.)	<i>M_{tg} / M_{ng}</i>
D6-33-3A	3	6	180	3.73	33.5	27.5	1.22	27.5	1.22
D6-33-3B	3	6	180	3.50	31.5	27.5	1.15	27.5	1.15
Average				3.61	32.5		1.18		1.18
D6-43-3A	3	6	137	4.16	37.4	40.0	0.94	40.0	0.94
D6-43-3B	3	6	137	4.29	38.6	40.0	0.96	40.0	0.96
D6-43-3C	3	6	137	4.00	36.0	40.0	0.90	40.0	0.90
Average				4.15	37.3		0.93		0.93
D6-54-3A	3	6	111	6.14	55.3	55.7	0.99	55.7	0.99
D6-54-3B	3	6	111	5.87	52.8	55.7	0.95	55.7	0.95
Average				6.00	54.0		0.97		0.97
D6-54-6A	6	12	111	5.43	65.2	55.7	1.17	55.7	1.17
D6-54-6B*	6	12	111	4.73	56.8	55.7	1.02	55.7	1.02
D6-54-6C	6	12	111	5.73	68.8	55.7	1.23	55.7	1.23
Average				5.30	63.6		1.14		1.14
D6-43-8A	8	16	137	4.11	65.1	37.5	1.74	37.5	1.74
D6-43-8B	8	16	137	4.00	63.3	37.5	1.69	37.5	1.69
Average				4.05	64.2		1.71		1.52
D6-54-8A	8	16	110	5.20	83.1	53.0	1.57	53.0	1.57
D6-54-8B	8	16	110	4.98	79.2	53.0	1.50	53.0	1.50
Average				5.09	81.2		1.53		1.53
D8-33-3A	3	4.5	235	4.46	40.2	52.5	0.77	52.5	0.77
D8-33-3B	3	4.5	235	4.30	38.7	52.5	0.74	52.5	0.74
D8-33-3C	3	4.5	235	4.12	37.1	52.5	0.71	52.5	0.71
Average				4.30	38.7		0.74		0.74

Metric Conversion: 1 kip. = 4.448 kN, 1 kip*in. = 0.112 kN*m

¹ Assembly designation is as follows: the first letter “D” or “S” represents double or single L-section, the first number is the vertical leg dimension (in.) of the L-section(s), the second number is the nominal thickness of the L-section (in.), and the last number is the clear span (ft).

* Outlier, not included in averages.

TABLE B1 cont. – Double L-header Strength Test Data (Gravity Loads)

Header Designation ¹	Span <i>L</i> (ft.)	<i>L/h</i>	<i>h/t</i>	Ultimate Test Load <i>P_t</i> (kip)	Test Moment <i>M_{te}</i> (kip*in.)	AISI – N.A. Specification (AISI S100-07)		AISI – Header Standard (AISI S212-07)	
						<i>M_{ng}</i> (kip*in.)	<i>M_{tg} / M_{ng}</i>	<i>M_{ng}</i> (kip*in.)	<i>M_{tg} / M_{ng}</i>
D8-43-3A	3	4.5	184	5.77	52.0	61.9	0.84	61.9	0.84
D8-43-3B	3	4.5	184	5.89	53.0	61.9	0.86	61.9	0.86
D8-43-3C	3	4.5	184	6.04	54.3	61.9	0.88	61.9	0.88
Average				5.90	53.1		0.86		0.86
D8-43-6A	6	9	184	5.79	69.5	61.9	1.12	61.9	1.12
D8-43-6B	6	9	184	5.96	71.5	61.9	1.15	61.9	1.15
Average				5.88	70.5		1.14		1.14
D8-54-6A	6	9	148	6.79	81.5	91.3	0.89	91.3	0.89
D8-54-6B	6	9	148	7.42	89.0	91.3	0.98	91.3	0.98
Average				7.10	85.3		0.93		0.93
D8-43-8A	8	12	183	5.40	86.0	61.8	1.39	61.8	1.39
D8-43-8B	8	12	183	5.53	88.1	61.8	1.42	61.8	1.42
Average				5.47	87.1		1.41		1.41
D8-54-8A	8	12	147	6.96	111	86.7	1.28	86.7	1.28
D8-54-8B	8	12	147	6.71	106	86.7	1.23	86.7	1.23
Average				6.83	109		1.26		1.26
D8-54-12A	12	18	147	5.17	113	86.7	1.31	86.7	1.31
D8-54-12B	12	18	147	5.25	115	86.7	1.32	86.7	1.32
Average				5.21	114		1.32		1.32
D8-68-12A	12	18	115	7.29	159	118	1.34	119	1.34
D8-68-12B	12	18	115	7.46	163	118	1.38	119	1.38
Average				7.38	161		1.36		1.36

Metric Conversion: 1 ft. = .305 m, 1 kip. = 4.448 kN, 1 kip*in. = 0.112 kN*m

¹ Assembly designation is as follows: the first letter “D” or “S” represents double or single L-section, the first number is the vertical leg dimension (in.) of the L-section(s), the second number is the nominal thickness of the L-section (in.), and the last number is the clear span (ft).

TABLE B1 cont. – Double L-header Strength Test Data (Gravity Loads)

Header Designation ¹	Span <i>L</i> (ft.)	<i>L/h</i>	<i>h/t</i>	Ultimate Test Load <i>P_t</i> (kip)	Test Moment <i>M_{te}</i> (kip*in.)	AISI – N.A. Specification (AISI S100-07)		AISI – Header Standard (AISI S212-07)	
						<i>M_{ng}</i> (kip*in.)	<i>M_{tg} / M_{ng}</i>	<i>M_{ng}</i> (kip*in.)	<i>M_{tg} / M_{ng}</i>
D8-54-16A	16	24	148	4.34	123	87.6	1.40	87.6	1.40
D8-54-16B	16	24	148	4.30	122	87.6	1.39	87.6	1.39
Average				4.32	122		1.40		1.40
D8-68-16A	16	24	115	5.99	167	120	1.40	120	1.40
D8-68-16B	16	24	115	5.82	163	120	1.36	120	1.36
Average				5.90	165		1.38		1.38
D10-33-3A	3	3.6	293	4.78	43.0	78.9	0.55	71.0	0.61
D10-33-3B	3	3.6	293	4.89	44.0	78.9	0.56	71.0	0.62
Average				4.84	43.5		0.55		0.61
D10-43-3A	3	3.6	230	5.76	51.9	92.3	0.56	83.1	0.62
D10-43-3B	3	3.6	230	6.18	55.7	92.3	0.60	83.1	0.67
Average				5.97	53.8		0.58		0.65
D10-43-6A	6	7.2	230	7.02	84.3	92.3	0.91	83.1	1.01
D10-43-6B	6	7.2	230	7.33	88.0	92.3	0.95	83.1	1.06
Average				7.18	86.1		0.93		1.04
D10-54-6A	6	7.2	185	9.08	109	135	0.81	122	0.89
D10-54-6B	6	7.2	185	9.36	112	135	0.83	122	0.92
Average				9.22	111		0.82		0.91
D10-43-8A	8	9.6	228	6.77	108	92.1	1.17	82.9	1.30
D10-43-8B	8	9.6	228	6.98	111	92.1	1.21	82.9	1.34
Average				6.87	109		1.19		1.32

Metric Conversion: 1 ft. = .305 m, 1 kip. = 4.448 kN, 1 kip*in. = 0.112 kN*m

¹ Assembly designation is as follows: the first letter “D” or “S” represents double or single L-section, the first number is the vertical leg dimension (in.) of the L-section(s), the second number is the nominal thickness of the L-section (in.), and the last number is the clear span (ft).

TABLE B1 cont. – Double L-header Strength Test Data (Gravity Loads)

Header Designation ¹	Span <i>L</i> (ft.)	<i>L/h</i>	<i>h/t</i>	Ultimate Test Load <i>P_t</i> (kip)	Test Moment <i>M_{te}</i> (kip*in.)	AISI – N.A. Specification (AISI S100-07)		AISI – Header Standard (AISI S212-07)	
						<i>M_{ng}</i> (kip*in.)	<i>M_{tg} / M_{ng}</i>	<i>M_{ng}</i> (kip*in.)	<i>M_{tg} / M_{ng}</i>
D10-54-8A	8	9.6	184	8.56	136	128	1.06	116	1.18
D10-54-8B	8	9.6	184	8.58	137	128	1.07	116	1.18
Average				8.57	137		1.06		1.18
D10-54-12A	12	14.4	184	7.45	163	128	1.27	128	1.27
D10-54-12B	12	14.4	184	7.36	161	128	1.26	128	1.26
Average				7.40	162		1.26		1.26
D10-68-12A	12	14.4	144	9.15	199	174	1.14	174	1.14
D10-68-12B	12	14.4	144	9.12	199	174	1.14	174	1.14
Average				9.14	199		1.14		1.14
D10-54-16A	16	19.2	185	5.12	144	130	1.11	130	1.11
D10-54-16B	16	19.2	185	5.21	145	130	1.12	130	1.12
Average				5.17	144		1.11		1.11
D10-68-16A	16	19.2	143	7.22	201	176	1.15	176	1.15
D10-68-16B	16	19.2	143	7.17	200	176	1.14	176	1.14
Average				7.19	201		1.14		1.14

Metric Conversion: 1 ft. = .305 m, 1 kip. = 4.448 kN, 1 kip*in. = 0.112 kN*m

¹ Assembly designation is as follows: the first letter “D” or “S” represents double or single L-section, the first number is the vertical leg dimension (in.) of the L-section(s), the second number is the nominal thickness of the L-section (in.), and the last number is the clear span (ft).

TABLE B2 – Single L-header Strength Test Data (Gravity Loads)

Header Designation ¹	Span <i>L</i> (ft.)	<i>L/h</i>	<i>h/t</i>	Ultimate Test Load <i>P_t</i> (kip)	Test Moment <i>M_{te}</i> (kip*in.)	AISI – N.A. Specification (AISI S100-07)		AISI – Header Standard (AISI S212-07)	
						<i>M_{ng}</i> (kip*in.)	<i>M_{tg} / M_{ng}</i>	<i>M_{ng}</i> (kip*in.)	<i>M_{tg} / M_{ng}</i>
S6-33-4A	4	8	180	1.37	16.5	13.7	1.20	13.7	1.20
S6-33-4B	4	8	180	1.47	17.6	13.7	1.28	13.7	1.28
S6-33-4C	4	8	180	1.67	20.0	13.7	1.46	13.7	1.46
Average				1.50	18.0		1.31		1.31
S6-43-4A	4	8	137	1.69	20.3	20.0	1.02	20.0	1.02
S6-43-4B	4	8	137	1.61	19.3	20.0	0.97	20.0	0.97
S6-43-4C	4	8	137	2.00	24.0	20.0	1.20	20.0	1.20
S6-43-4D	4	8	137	1.88	22.5	20.0	1.12	20.0	1.12
Average				1.80	21.6		1.08		1.08
S6-33-6A	6	12	180	1.71	20.6	13.7	1.50	N/A	
S6-33-6B	6	12	180	1.71	20.6	13.7	1.50	N/A	
S6-33-6C	6	12	180	1.73	20.7	13.7	1.51	N/A	
Average				1.72	20.6		1.50		N/A
S6-43-6A	6	12	137	1.93	23.1	20.0	1.16	N/A	
S6-43-6B	6	12	137	2.29	27.5	20.0	1.37	N/A	
S6-43-6C*	6	12	137	3.21	38.5	20.0	1.93	N/A	
Average				2.11	25.3		1.26		N/A
S6-43-8A	8	16	137	2.27	35.7	18.8	1.90	N/A	
S6-43-8B	8	16	137	2.25	35.5	18.8	1.89	N/A	
Average				2.26	35.6		1.90		N/A
S6-54-8A	8	16	110	2.71	42.6	26.5	1.61	N/A	
S6-54-8B	8	16	110	2.66	42.1	26.5	1.59	N/A	
Average				2.68	42.3		1.60		N/A

Metric Conversion: 1 ft. = .305 m, 1 kip. = 4.448 kN, 1 kip*in. = 0.112 kN*m

¹ Assembly designation is as follows: the first letter “D” or “S” represents double or single L-section, the first number is the vertical leg dimension (in.) of the L-section(s), the second number is the nominal thickness of the L-section (in.), and the last number is the clear span (ft).

*Outlier, not included in averages.

TABLE B2 cont. – Single L-header Strength Test Data (Gravity Loads)

Header Designation ¹	Span <i>L</i> (ft.)	<i>L/h</i>	<i>h/t</i>	Ultimate Test Load <i>P_t</i> (kip)	Test Moment <i>M_{te}</i> (kip*in.)	AISI – N.A. Specification (AISI S100-07)		AISI – Header Standard (AISI S212-07)	
						<i>M_{ng}</i> (kip*in.)	<i>M_{tg} / M_{ng}</i>	<i>M_{ng}</i> (kip*in.)	<i>M_{tg} / M_{ng}</i>
S8-33-4A	4	6	235	1.66	20.0	26.3	0.76	23.6	0.85
S8-33-4B	4	6	235	1.64	19.7	26.3	0.75	23.6	0.83
S8-33-4C	4	6	235	1.79	21.5	26.3	0.82	23.6	0.91
S8-33-4D	4	6	235	1.81	21.7	26.3	0.83	23.6	0.92
Average				1.73	20.7		0.79		0.88
S8-43-4A	4	6	184	2.50	30.0	31.0	0.97	27.9	1.07
S8-43-4B	4	6	184	2.20	26.4	31.0	0.85	27.9	0.95
S8-43-4C	4	6	184	2.42	29.0	31.0	0.94	27.9	1.04
S8-43-4D	4	6	184	2.63	31.6	31.0	1.02	27.9	1.13
Average				2.44	29.2		0.94		1.05
S8-54-4A	4	6	148	2.85	34.2	45.6	0.75	41.1	0.83
S8-54-4B	4	6	148	2.78	33.4	45.6	0.73	41.1	0.81
Average				2.81	33.8		0.74		0.82
S8-43-6A	6	9	184	2.33	27.9	27.9	1.00	N/A	
S8-43-6B	6	9	184	2.88	34.6	27.9	1.24	N/A	
Average				2.61	31.3		1.12		N/A
S8-43-8A	8	12	183	3.05	47.9	27.8	1.72	N/A	
S8-43-8B	8	12	183	2.96	46.4	27.8	1.67	N/A	
Average				3.01	47.2		1.70		N/A
S8-54-8A	8	12	147	4.01	63.4	39.0	1.62	N/A	
S8-54-8B	8	12	147	3.94	61.9	39.0	1.59	N/A	
Average				3.98	62.7		1.61		N/A

Metric Conversion: 1 ft. = .305 m, 1 kip. = 4.448 kN, 1 kip*in. = 0.112 kN*m

¹ Assembly designation is as follows: the first letter “D” or “S” represents double or single L-section, the first number is the vertical leg dimension (in.) of the L-section(s), the second number is the nominal thickness of the L-section (in.), and the last number is the clear span (ft).

TABLE B2 cont. – Single L-header Strength Test Data (Gravity Loads)

Header Designation ¹	Span <i>L</i> (ft.)	<i>L/h</i>	<i>h/t</i>	Ultimate Test Load <i>P_t</i> (kip)	Test Moment <i>M_{te}</i> (kip*in.)	AISI – N.A. Specification (AISI S100-07)		AISI – Header Standard (AISI S212-07)	
						<i>M_{ng}</i> (kip*in.)	<i>M_{tg} / M_{ng}</i>	<i>M_{ng}</i> (kip*in.)	<i>M_{tg} / M_{ng}</i>
S10-33-4A	4	4.8	293	2.12	25.5	39.5	0.64	N/A	
S10-33-4B	4	4.8	293	2.09	25.1	39.5	0.64	N/A	
S10-33-4C	4	4.8	293	2.31	27.8	39.5	0.70	N/A	
Average				2.18	26.1		0.66		N/A
S10-54-4A	4	4.8	185	3.51	42.2	67.6	0.62	N/A	
S10-54-4B	4	4.8	185	3.19	38.2	67.6	0.57	N/A	
S10-54-4C	4	4.8	185	3.55	42.6	67.6	0.63	N/A	
S10-54-4D	4	4.8	185	3.80	45.6	67.6	0.67	N/A	
Average				3.51	42.1		0.62		N/A
S10-43-6A	6	7.2	230	3.33	40.0	46.1	0.87	N/A	
S10-43-6B	6	7.2	230	3.67	44.0	46.1	0.95	N/A	
Average				3.50	42.0		0.91		N/A
S10-54-6A	6	7.2	185	4.46	53.5	67.6	0.79	N/A	
S10-54-6B	6	7.2	185	4.75	57.0	67.6	0.84	N/A	
Average				4.60	55.2		0.82		N/A
S10-43-8A	8	9.6	228	3.76	59.2	46.0	1.29	N/A	
S10-43-8B	8	9.6	228	3.78	59.5	46.0	1.29	N/A	
Average				3.77	59.4		1.29		N/A
S10-54-8A	8	9.6	184	4.87	76.8	64.2	1.20	N/A	
S10-54-8B	8	9.6	184	4.40	69.5	64.2	1.08	N/A	
Average				4.64	73.1		1.14		N/A

Metric Conversion: 1 ft. = .305 m, 1 kip. = 4.448 kN, 1 kip*in. = 0.112 kN*m

¹ Assembly designation is as follows: the first letter “D” or “S” represents double or single L-section, the first number is the vertical leg dimension (in.) of the L-section(s), the second number is the nominal thickness of the L-section (in.), and the last number is the clear span (ft).

TABLE B3 – Double L-header NAHB and UW Comparison of Results (Gravity Loads)

Header Designation	Test Location	Average Ultimate Load P_t (kip)	Average Test Moment, M_{tg} (kip*in.)	AISI – N.A. Specification (AISI S100-07)		AISI – Header Standard (AISI S212-07)	
				M_{ng} (kip*in.)	M_{tg} / M_{ng}	M_{ng} (kip*in.)	M_{tg} / M_{ng}
D6-33-3	UW	3.61	32.5	27.5	1.18	27.5	1.18
	NAHB	2.28	20.5	20.3	1.01	20.3	1.01
D6-43-3	UW	4.15	37.3	40.0	0.93	40.0	0.93
	NAHB	3.24	29.2	31.0	0.94	31.0	0.94
D6-54-3	UW	6.00	54.0	55.7	0.97	55.7	0.97
	NAHB	5.59	50.3	55.6	0.90	55.6	0.90
D6-54-6	UW	5.30	63.6	55.7	1.14	55.7	1.14
	NAHB	6.27	75.3	55.6	1.35	55.6	1.35
D8-33-3	UW	4.30	38.7	52.5	0.74	52.5	0.74
	NAHB	4.47	40.2	44.8	0.90	44.8	0.90
D8-43-3	UW	5.90	53.1	61.9	0.86	61.9	0.86
	NAHB	5.74	51.7	52.1	0.99	52.1	0.99
D8-43-6	UW	5.88	70.5	61.9	1.14	61.9	1.14
	NAHB	5.18	62.1	52.1	1.19	52.1	1.19
D8-54-6	UW	7.10	85.3	91.3	0.93	91.3	0.93
	NAHB	7.19	86.3	89.0	0.97	89.0	0.97
D8-43-8	UW	5.47	87.1	61.8	1.41	61.8	1.41
	NAHB	5.30	84.7	52.1	1.63	52.1	1.63
D8-54-8	UW	6.83	109	86.7	1.26	86.7	1.26
	NAHB	7.25	116	89.0	1.30	89.0	1.30
D8-68-12	UW	7.38	161	119	1.36	119	1.36
	NAHB	7.22	173	122	1.42	122	1.42
D8-54-16	UW	4.32	122	87.6	1.40	87.6	1.40
	NAHB	3.20	102	89.0	1.15	89.0	1.15
D8-68-16	UW	5.90	165	120	1.38	120	1.38
	NAHB	5.72	183	122	1.50	122	1.50
D10-33-3	UW	4.84	43.5	78.9	0.55	71.0	0.61
	NAHB	4.36	39.3	64.7	0.61	58.2	0.67
D10-43-6	UW	7.18	86.1	92.3	0.93	83.1	1.04
	NAHB	7.17	86.0	103	0.84	92.4	0.93
D10-54-6	UW	9.22	111	135	0.82	122	0.91
	NAHB	8.17	98.0	132	0.74	119	0.83
D10-43-8	UW	6.87	109	92.1	1.19	82.9	1.32
	NAHB	4.14	66.2	103	0.64	92.4	0.72
D10-54-8	UW	8.57	137	128	1.06	115	1.18
	NAHB	6.59	105	132	0.80	119	0.89
D10-54-12	UW	7.40	162	128	1.26	128	1.26
	NAHB	6.50	156	132	1.18	132	1.18
D10-68-12	UW	9.14	199	174	1.14	174	1.14
	NAHB	8.97	215	177	1.21	177	1.21
D10-54-16	UW	5.17	144	130	1.11	130	1.11
	NAHB	5.44	174	132	1.32	132	1.32
D10-68-16	UW	7.19	201	176	1.14	176	1.14
	NAHB	7.05	225	177	1.27	177	1.27

Metric Conversion: 1 ft. = .305 m, 1 kip = 4.448 kN, 1 kip*in. = 0.112 kN*m

TABLE B4 – Single L-header NAHB and UW Comparison of Results (Gravity Loads)

Header Designation	Test Location	Average Ultimate Load P_t (kip)	Average Test Moment, M_{tg} (kip*in.)	AISI – N.A. Specification (AISI S100-07)		AISI – Header Standard (AISI S212-07)	
				M_{ng} (kip*in.)	M_{tg} / M_{ng}	M_{ng} (kip*in.)	M_{tg} / M_{ng}
S6-33-4	UW	1.50	18.0	13.7	1.31	13.7	1.31
	NAHB	1.82	21.8	10.8 ²	2.02	10.8	2.02
S6-43-4	UW	1.80	21.6	20.0	1.08	20.0	1.08
	NAHB	2.18	26.2	16.4 ²	1.59	16.4	1.59
S8-33-4	UW	1.73	20.7	26.3	0.79	23.6	0.88
	NAHB	2.22	26.6	17.4 ²	1.53	15.6	1.70
S8-43-4	UW	2.44	29.2	31.0	0.94	27.9	1.05
	NAHB	2.84	34.1	25.5 ²	1.34	22.9	1.48
S8-54-4	UW	2.81	33.8	45.6	0.74	41.1	0.82
	NAHB	3.22	38.6	44.0 ²	0.88	39.6	0.97

Metric Conversion: 1 ft. = .305 m, 1 kip. = 4.448 kN, 1 kip*in. = 0.112 kN*m

¹ Assembly designation is as follows: the first letter “D” or “S” represents double or single L-section, the first number is the vertical leg dimension (in.) of the L-section(s), the second number is the nominal thickness of the L-section (in.), and the last number is the clear span (ft).

² Nominal flexural strength computed based on 2000 version of the AISI Specification (AISI, 2001a)

TABLE B5 – Double L-header Prop. Flexural Design Equation (Gravity Loads)

	Header Designation ¹	Span <i>L</i> (ft.)	<i>L/h</i>	<i>h/t</i>	Test Moment <i>M_{ig}</i> (kip*in.)	Proposed Prediction Equation	
						<i>M_{ng}</i> (kip*in.)	<i>M_{ig} / M_{ng}</i>
UNIVERSITY OF WATERLOO TESTS	D6-33-3A	3	6	180	33.5	25.6	1.31
	D6-33-3B	3	6	180	31.5	25.6	1.23
	D6-43-3A	3	6	137	37.4	39.7	0.94
	D6-43-3B	3	6	137	38.6	39.7	0.97
	D6-43-3C	3	6	137	36.0	39.7	0.91
	D6-54-3A	3	6	111	55.3	57.6	0.96
	D6-54-3B	3	6	111	52.8	57.6	0.92
	D6-54-6A	6	12	111	65.2	69.9	0.93
	D6-54-6B*	6	12	111	56.8	N/A	N/A
	D6-54-6C	6	12	111	68.8	69.9	0.98
	D6-43-8A	8	16	137	65.1	49.2	1.32
	D6-43-8B	8	16	137	63.3	49.2	1.29
	D6-54-8A	8	16	110	83.1	72.4	1.15
	D6-54-8B	8	16	110	79.2	72.4	1.09
	D8-33-3A	3	4.5	235	40.2	42.1	0.95
	D8-33-3B	3	4.5	235	38.7	42.1	0.92
	D8-33-3C	3	4.5	235	37.1	42.1	0.88
	D8-43-3A	3	4.5	184	52.0	53.2	0.98
	D8-43-3B	3	4.5	184	53.0	53.2	0.99
	D8-43-3C	3	4.5	184	54.3	53.2	1.02
	D8-43-6A	6	9	184	69.5	64.2	1.08
	D8-43-6B	6	9	184	71.5	64.2	1.11
	D8-54-6A	6	9	148	81.5	99.6	0.82
	D8-54-6B	6	9	148	89.0	99.6	0.89
	D8-43-8A	8	12	183	86.0	69.7	1.23
	D8-43-8B	8	12	183	88.1	69.7	1.26
	D8-54-8A	8	12	147	111	103	1.08
	D8-54-8B	8	12	147	107	103	1.04
	D8-54-12A	12	18	147	113	116	0.98
	D8-54-12B	12	18	147	115	116	0.99
	D8-68-12A	12	18	115	159	167	0.95
	D8-68-12B	12	18	115	163	167	0.98
	D8-54-16A	16	24	148	123	128	0.96
	D8-54-16B	16	24	148	122	128	0.95
	D8-68-16A	16	24	115	167	184	0.91
	D8-68-16B	16	24	115	163	184	0.89
D10-33-3A	3	3.6	293	43.0	55.5	0.78	
D10-33-3B	3	3.6	293	44.0	55.5	0.79	

Metric Conversion: 1 ft. = .305 m, 1 kip*in. = 0.112 kN*m

¹ Assembly designation is as follows: the first letter “D” or “S” represents double or single L-section, the first number is the vertical leg dimension (in.) of the L-section(s), the second number is the nominal thickness of the L-section (in.), and the last number is the clear span (ft).

* Outlier, not included in averages.

TABLE B5 cont. – Double L-header Prop. Flexural Design Equation (Gravity Loads)

	Header Designation ¹	Span <i>L</i> (ft.)	<i>L/h</i>	<i>h/t</i>	Test Moment <i>M_{tg}</i> (kip*in.)	Proposed Prediction Equation	
						<i>M_{ng}</i> (kip*in.)	<i>M_{ig} / M_{ng}</i>
UW TESTS	D10-43-3A	3	3.6	230	51.9	70.4	0.74
	D10-43-3B	3	3.6	230	55.7	70.4	0.79
	D10-43-6A	6	7.2	230	84.3	84.4	1.00
	D10-43-6B	6	7.2	230	88.0	84.4	1.04
	D10-54-6A	6	7.2	185	109	131.6	0.83
	D10-54-6B	6	7.2	185	112	131.6	0.85
	D10-43-8A	8	9.6	228	108	91.5	1.18
	D10-43-8B	8	9.6	228	111	91.5	1.21
	D10-54-8A	8	9.6	184	136	135.4	1.01
	D10-54-8B	8	9.6	184	137	135.4	1.01
	D10-54-12A	12	14.4	184	163	152.3	1.07
	D10-54-12B	12	14.4	184	161	152.3	1.06
	D10-68-12A	12	14.4	144	199	219.1	0.91
	D10-68-12B	12	14.4	144	199	219.1	0.91
	D10-54-16A	16	19.2	185	144	167.7	0.86
	D10-54-16B	16	19.2	185	145	167.7	0.87
	D10-68-16A	16	19.2	143	201	240.9	0.84
	D10-68-16B	16	19.2	143	200	240.9	0.83
NAHB-RC TESTS		3	6	130	28.8	31.2	0.92
		3	6	130	29.5	31.2	0.95
		3	6	103	50.3	58.2	0.86
		6	12	103	67.8	70.6	0.96
		6	12	103	73.4	70.6	1.04
		6	12	103	85.3	70.6	1.21
		6	12	103	74.4	70.6	1.05
		3	4.5	233	38.7	36.0	1.08
		3	4.5	233	41.7	36.0	1.16
		3	4.5	171	53.7	46.0	1.18
		3	4.5	171	49.6	46.0	1.09
		6	9	171	62.4	55.0	1.14
		6	9	171	61.8	55.0	1.12
		8	12	171	82.2	59.7	1.38
		8	12	171	87.2	59.7	1.46
		6	9	144	85.9	97.6	0.88
		6	9	144	86.8	97.6	0.89
		8	12	144	116	106	1.09
	8	12	144	116	106	1.10	

Metric Conversion: 1 ft. = .305 m, 1 kip*in. = 0.112 kN*m

¹ Assembly designation is as follows: the first letter “D” or “S” represents double or single L-section, the first number is the vertical leg dimension (in.) of the L-section(s), the second number is the nominal thickness of the L-section (in.), and the last number is the clear span (ft).

TABLE B5 cont. – Double L-header New Flexural Design Equation (Gravity Loads)

	Header Designation ¹	Span <i>L</i> (ft.)	<i>L/h</i>	<i>h/t</i>	Test Moment <i>M_{tg}</i> (kip*in.)	Proposed Prediction Equation	
						<i>M_{ng}</i> (kip*in.)	<i>M_{tg} / M_{ng}</i>
NAHB-RC TESTS		11.5	17.25	144	96.6	118	0.82
		11.5	17.25	144	96.6	118	0.82
		6	7.2	210	83.8	96.5	0.87
		6	7.2	210	88.1	96.5	0.91
		3	3.6	292	40.5	45.6	0.89
		3	3.6	292	38.1	45.6	0.84
		6	7.2	292	56.9	54.6	1.04
		6	7.2	292	45.9	54.6	0.84
		3	6	176	20.1	19.0	1.06
		3	6	176	20.8	19.0	1.09
		6	7.2	173	103	130	0.79
		6	7.2	173	92.7	130	0.71
		12	18	110	185	173	1.07
		12	18	110	161	173	0.93
		16	24	110	179	188	0.95
		16	24	110	187	188	0.99
		12	14.4	173	155	159	0.98
		12	14.4	173	157	159	0.99
		16	19.2	173	174	173	1.00
		16	19.2	173	174	173	1.01
	12	14.4	138	217	225	0.97	
	12	14.4	138	213	225	0.95	
	16	19.2	138	231	245	0.94	
	16	19.2	138	219	245	0.89	
						Average	0.99
						Standard Deviation	0.14
						COV	0.14

Metric Conversion: 1 ft. = .305 m, 1 kip*in. = 0.112 kN*m

¹ Assembly designation is as follows: the first letter “D” or “S” represents double or single L-section, the first number is the vertical leg dimension (in.) of the L-section(s), the second number is the nominal thickness of the L-section (in.), and the last number is the clear span (ft).

TABLE B6 – Single L-header New Flexural Design Equation (Gravity Loads)

	Header Designation ¹	Span <i>L</i> (ft.)	<i>L/h</i>	<i>h/t</i>	Test Moment <i>M_{ig}</i> (kip*in.)	Proposed Prediction Equation	
						<i>M_{ng}</i> (kip*in.)	<i>M_{ig} / M_{ng}</i>
UNIVERSITY OF WATERLOO TESTS	S6-33-4A	4	8	180	16.5	14.1	1.17
	S6-33-4B	4	8	180	17.6	14.1	1.25
	S6-33-4C	4	8	180	20.0	14.1	1.42
	S6-43-4A	4	8	137	20.3	20.5	0.99
	S6-43-4B	4	8	137	19.3	20.5	0.94
	S6-43-4C*	4	8	137	24.0	20.5	1.17
	S6-43-4D	4	8	137	22.5	20.5	1.10
	S6-33-6A	6	12	180	20.6	19.2	1.07
	S6-33-6B	6	12	180	20.6	19.2	1.07
	S6-33-6C	6	12	180	20.7	19.2	1.08
	S6-43-6A	6	12	137	23.1	28.0	0.82
	S6-43-6B	6	12	137	27.5	28.0	0.98
	S6-43-6C*	6	12	137	38.5	N/A	N/A
	S6-43-8A	8	16	137	35.7	32.8	1.09
	S6-43-8B	8	16	137	35.5	32.8	1.08
	S6-54-8A	8	16	110	42.6	46.4	0.92
	S6-54-8B	8	16	110	42.1	46.4	0.91
	S8-33-4A	4	6	235	20.0	21.7	0.92
	S8-33-4B	4	6	235	19.7	21.7	0.91
	S8-33-4C	4	6	235	21.5	21.7	0.99
	S8-33-4D	4	6	235	21.7	21.7	1.00
	S8-43-4A	4	6	184	30.0	25.6	1.17
	S8-43-4B	4	6	184	26.4	25.6	1.03
	S8-43-4C	4	6	184	29.0	25.6	1.14
	S8-43-4D	4	6	184	31.6	25.6	1.23
	S8-54-4A	4	6	148	34.2	37.7	0.91
	S8-54-4B	4	6	148	33.4	37.7	0.88
	S8-43-6A	6	9	184	28.0	34.8	0.80
	S8-43-6B	6	9	184	34.6	34.8	1.00
	S8-43-8A	8	12	183	47.9	43.3	1.11
	S8-43-8B	8	12	183	46.4	43.3	1.07
	S8-54-8A	8	12	147	63.4	60.7	1.04
	S8-54-8B	8	12	147	62.0	60.7	1.02
	S10-33-4A	4	4.8	293	25.5	27.6	0.92
	S10-33-4B	4	4.8	293	25.1	27.6	0.91
	S10-33-4C	4	4.8	293	27.8	27.6	1.01

Metric Conversion: 1 ft. = .305 m, 1 kip*in. = 0.112 kN*m

¹ Assembly designation is as follows: the first letter “D” or “S” represents double or single L-section, the first number is the vertical leg dimension (in.) of the L-section(s), the second number is the nominal thickness of the L-section (in.), and the last number is the clear span (ft).

* Outlier, not included in averages.

TABLE B6 cont. – Single L-header New Flexural Design Equation (Gravity Loads)

	Header Designation ¹	Span <i>L</i> (ft.)	<i>L/h</i>	<i>h/t</i>	Test Moment <i>M_{ig}</i> (kip*in.)	Proposed Prediction Equation	
						<i>M_{ng}</i> (kip*in.)	<i>M_{ig} / M_{ng}</i>
UW TESTS	S10-54-4A	4	4.8	185	42.2	47.3	0.89
	S10-54-4B	4	4.8	185	38.2	47.3	0.81
	S10-54-4C	4	4.8	185	42.6	47.3	0.90
	S10-54-4D	4	4.8	185	45.6	47.3	0.96
	S10-43-6A	6	7.2	230	40.0	43.7	0.91
	S10-43-6B	6	7.2	230	44.0	43.7	1.01
	S10-54-6A	6	7.2	185	53.5	64.1	0.83
	S10-54-6B	6	7.2	185	57.0	64.1	0.89
	S10-43-8A	8	9.6	228	59.2	54.3	1.09
	S10-43-8B	8	9.6	228	59.5	54.3	1.10
	S10-54-8A	8	9.6	184	76.8	75.7	1.01
	S10-54-8B	8	9.6	184	69.5	75.7	0.92
						Average	1.01
						Standard Deviation	0.12
						COV	0.12

Metric Conversion: 1 ft. = .305 m, 1 kip*in. = 0.112 kN*m

¹ Assembly designation is as follows: the first letter “D” or “S” represents double or single L-section, the first number is the vertical leg dimension (in.) of the L-section(s), the second number is the nominal thickness of the L-section (in.), and the last number is the clear span (ft).

TABLE B7 – Short Span Double L-header Deflection Test Data (Gravity Loads)

Assembly Designation ¹	Span L (ft.)	L/h	h/t	Load at L/240 (kip.)	Deflection at Service Load Level (in.)	L/240 Limit (in.)
D6-33-3A ²	3	6	180	3.38	0.10	0.15
D6-33-3B ²	3	6	180	2.46	0.14	
Average				2.92	0.12	
D6-43-3A ²	3	6	137	2.94	0.13	0.15
D6-43-3B ²	3	6	137	3.42	0.11	
D6-43-3C ³	3	6	137	3.93	0.06 ³	
Average				3.18	0.12	
D6-54-3A ²	3	6	111	3.54	0.15	0.15
D6-54-3B ²	3	6	111	3.39	0.16	
Average				3.47	0.15	
D8-33-3A ²	3	4.5	235	4.00	0.09	0.15
D8-33-3B ²	3	4.5	235	3.84	0.10	
D8-33-3C ³	3	4.5	235	4.08	0.05 ³	
Average				3.92	0.10	
D8-43-3A ²	3	4.5	184	4.30	0.12	0.15
D8-43-3B ²	3	4.5	184	4.30	0.12	
D8-43-3C ³	3	4.5	184	5.76	0.07 ³	
Average				4.30	0.12	
D10-33-3A ²	3	3.6	293	4.14	0.10	0.15
D10-33-3B ²	3	3.6	293	4.13	0.10	
Average				4.13	0.10	
D10-43-3A ²	3	3.6	230	4.56	0.12	0.15
D10-43-3B ²	3	3.6	230	4.12	0.13	
Average				4.34	0.12	
D6-54-6A	6	12	111	3.95	0.24	0.30
D6-54-6B*	6	12	111	4.03	0.22	
D6-54-6C	6	12	111	4.38	0.21	
Average				4.16	0.22	
D8-43-6A	6	9	184	5.64	0.14	0.30
D8-43-6B	6	9	184	5.88	0.16	
Average				5.76	0.15	

Metric Conversion: 1 ft. = .305 m, 1 kip = 4.448 kN, 1 in. = 25.4mm

¹ Assembly designation is as follows: the first letter “D” or “S” represents double or single L-section, the first number is the vertical leg dimension (in.) of the L-section(s), the second number is the nominal thickness of the L-section (in.), and the last number is the clear span (ft).

² Deflection readings are of top track.

³ Retested – Deflection readings are of bottom track.

⁴ LMT not working correctly – deflection reading not appropriate

* Outlier, not included averages.

TABLE B7 cont. – Short Span Double L-header Deflection Test Data (Gravity Loads)

Assembly Designation¹	Span L (ft.)	L/h	h/t	Load at L/240 (kip.)	Deflection at Service Load Level (in.)	L/240 Limit (in.)
D8-54-6A	6	9	148	6.54	0.15	0.30
D8-54-6B	6	9	148	7.18	0.16	
Average				6.86	0.15	
D10-43-6A ⁴	6	7.2	230	N/A	N/A	0.30
D10-43-6B ⁴	6	7.2	230	N/A	N/A	
Average				N/A	N/A	
D10-54-6A	6	7.2	185	9.04	0.15	0.30
D10-54-6B	6	7.2	185	9.17	0.16	
Average				9.11	0.15	

Metric Conversion: 1 ft. = .305 m, 1 kip = 4.448 kN, 1 in. = 25.4mm

¹ Assembly designation is as follows: the first letter “D” or “S” represents double or single L-section, the first number is the vertical leg dimension (in.) of the L-section(s), the second number is the nominal thickness of the L-section (in.), and the last number is the clear span (ft).

⁴ LMT not working correctly – deflection readings not appropriate

* Outlier, not included averages.

TABLE B8 – Long Span Double L-header Deflection Test Data (Gravity Loads)

Assembly Designation ¹	Span L (ft.)	L/h	h/t	Load at L/240 (kip.)	Deflection at Service Load Level (in.)	L/240 Limit (in.)	Semi-Rigid Properties	
							Fixity Factor r	End-Connection Stiffness (kip*in./rad.)
D6-43-8A	8	16	137	2.53	0.38	0.40	0.11	224
D6-43-8B	8	16	137	2.33	0.42		0.09	174
Average				2.43	0.40		0.10	199
D6-54-8A	8	16	110	3.07	0.40	0.40	0.09	250
D6-54-8B	8	16	110	2.97	0.41		0.09	229
Average				3.02	0.40		0.09	239
D8-43-8A	8	12	183	4.30	0.27	0.40	0.07	323
D8-43-8B	8	12	183	4.54	0.25		0.09	417
Average				4.42	0.26		0.08	370
D8-54-8A	8	12	147	5.09	0.30	0.40	0.04	250
D8-54-8B	8	12	147	4.76	0.34		0.01	51.3
Average				4.93	0.32		0.03	151
D10-43-8A	8	9.6	228	6.16	0.22	0.40	0.02	185
D10-43-8B	8	9.6	228	6.26	0.21		0.03	256
Average				6.21	0.22		0.03	221
D10-54-8A	8	9.6	184	7.78	0.20	0.40	0.04	450
D10-54-8B	8	9.6	184	7.17	0.25		-0.02	----
Average				7.48	0.23		0.01	225
D8-54-12A	12	18	147	3.28	0.57	0.60	0.05	184
D8-54-12B	12	18	147	3.43	0.53		0.06	211
Average				3.36	0.55		0.05	198
D8-68-12A	12	18	115	4.18	0.64	0.60	0.04	210
D8-68-12B	12	18	115	4.36	0.61		0.05	237
Average				4.27	0.63		0.05	223
D10-54-12A	12	14.4	184	5.74	0.42	0.60	0.05	366
D10-54-12B	12	14.4	184	5.47	0.46		0.04	295
Average				5.61	0.44		0.05	330
D10-68-12A	12	14.4	144	6.79	0.47	0.60	0.03	290
D10-68-12B	12	14.4	144	6.65	0.48		0.02	203
Average				6.72	0.47		0.03	246
D8-54-16A	16	24	148	2.45	0.86	0.80	0.05	138
D8-54-16B	16	24	148	2.34	0.91		0.05	129
Average				2.39	0.89		0.05	134
D8-68-16A	16	24	115	2.88	1.02	0.80	0.04	149
D8-68-16B	16	24	115	2.88	1.03		0.04	146
Average				2.88	1.03		0.04	147
D10-54-16A	16	19.2	185	3.89	0.59	0.80	0.05	237
D10-54-16B	16	19.2	185	3.84	0.61		0.04	226
Average				3.86	0.60		0.04	231
D10-68-16A	16	19.2	143	4.54	0.75	0.80	0.03	217
D10-68-16B	16	19.2	143	4.53	0.75		0.03	214
Average				4.54	0.75		0.03	215

TABLE B9 – Short Span Single L-header Deflection Test Data (Gravity Loads)

Assembly Designation ¹	Span L (ft.)	L/h	h/t	Load at L/240 (kip.)	Deflection at Service Load Level (in.)	L/240 Limit (in.)
S6-33-4A ²	4	8	180	1.28	0.14	0.20
S6-33-4B ²	4	8	180	1.19	0.15	
S6-33-4C ³	4	8	180	1.65	0.07 ³	
Average				1.24	0.14	
S6-43-4A ²	4	8	137	1.54	0.13	0.20
S6-43-4B ²	4	8	137	1.45	0.15	
S6-43-4C*	4	8	137	1.19	0.18	
S6-43-4D ²	4	8	137	1.51	0.15	
Average				1.50	0.14	
S8-33-4A ²	4	6	235	1.47	0.13	0.20
S8-33-4B ²	4	6	235	1.50	0.14	
S8-33-4C ²	4	6	235	1.77	0.09	
S8-33-4D ²	4	6	235	1.77	0.12	
Average				1.63	0.12	
S8-43-4A ²	4	6	184	1.80	0.17	0.20
S8-43-4B ²	4	6	184	2.06	0.14	
S8-43-4C ²	4	6	184	2.21	0.13	
S8-43-4D ³	4	6	184	2.63	0.06 ³	
Average				2.02	0.14	
S8-54-4A ²	4	6	148	2.62	0.11	0.20
S8-54-4B ²	4	6	148	2.46	0.13	
Average				2.54	0.12	
S10-33-4A ²	4	4.8	293	2.00	0.13	0.20
S10-33-4B ²	4	4.8	293	1.92	0.14	
S10-33-4C ³	4	4.8	293	2.27	0.06 ³	
Average				1.96	0.13	
S10-54-4A ²	4	4.8	185	3.04	0.13	0.20
S10-54-4B ²	4	4.8	185	2.93	0.13	
S10-54-4C ²	4	4.8	185	2.91	0.15	
S10-54-4D ³	4	4.8	185	3.79	0.06 ³	
Average				2.96	0.14	
S6-33-6A	6	12	180	1.66	0.15	0.30
S6-33-6B	6	12	180	1.51	0.16	
S6-33-6C	6	12	180	1.40	0.20	
Average				1.52	0.17	

Metric Conversion: 1 ft. = .305 m, 1 kip = 4.448 kN, 1 in. = 25.4mm

¹ Assembly designation is as follows: the first letter “D” or “S” represents double or single L-section, the first number is the vertical leg dimension (in.) of the L-section(s), the second number is the nominal thickness of the L-section (in.), and the last number is the clear span (ft).

² Deflection readings are of top track.

³ Retested – Deflection readings are of bottom track.

* Outlier, not included averages.

TABLE B9 cont. – Short Span Single L-header Deflection Test Data (Gravity Loads)

Assembly Designation ¹	Span <i>L</i> (ft.)	<i>L/h</i>	<i>h/t</i>	Load at <i>L/240</i> (kip.)	Deflection at Service Load Level (in.)	<i>L/240</i> Limit (in.)
S6-43-6A	6	12	137	1.67	0.20	0.30
S6-43-6B	6	12	137	1.98	0.17	
S6-43-6C*	6	12	137	2.86	0.10	
Average				1.83	0.18	
S8-43-6A	6	9	184	2.08	0.18	0.30
S8-43-6B	6	9	184	2.32	0.17	
Average				2.20	0.17	
S10-43-6A	6	7.2	230	2.82	0.16	0.30
S10-43-6B	6	7.2	230	3.09	0.15	
Average				2.96	0.15	
S10-54-6A	6	7.2	185	3.46	0.22	0.30
S10-54-6B	6	7.2	185	3.54	0.20	
Average				3.50	0.21	

Metric Conversion: 1 ft. = .305 m, 1 kip = 4.448 kN, 1 in. = 25.4mm

¹ Assembly designation is as follows: the first letter “D” or “S” represents double or single L-section, the first number is the vertical leg dimension (in.) of the L-section(s), the second number is the nominal thickness of the L-section (in.), and the last number is the clear span (ft).

* Outlier, not included averages.

TABLE B10 – Long Span Single L-header Deflection Test Data (Gravity Loads)

Assembly Designation ¹	Span L (ft.)	L/h	h/t	Load at L/240 (kip.)	Deflection at Service Load Level (in.)	L/240 Limit (in.)	Semi-Rigid Properties	
							Fixity Factor <i>r</i>	End-Connection Stiffness (kip*in./rad.)
S6-43-8A	8	16	137	1.24	0.44	0.40	0.10	104
S6-43-8B	8	16	137	1.21	0.45		0.09	95.9
Average				1.23	0.45		0.10	100
S6-54-8A	8	16	110	1.50	0.43	0.40	0.09	113
S6-54-8B	8	16	110	1.65	0.38		0.11	151
Average				1.58	0.41		0.10	132
S8-43-8A	8	12	183	2.25	0.30	0.40	0.07	161
S8-43-8B	8	12	183	2.11	0.32		0.05	111
Average				2.18	0.31		0.06	136.
S8-54-8A	8	12	147	2.54	0.36	0.40	0.03	88.7
S8-54-8B	8	12	147	2.62	0.36		0.04	98.3
Average				2.58	0.36		0.03	93.5
S10-43-8A	8	9.6	228	3.09	0.24	0.40	0.02	80.2
S10-43-8B	8	9.6	228	3.17	0.25		0.02	66.5
Average				3.13	0.24		0.02	73.4
S10-54-8A	8	9.6	184	3.82	0.26	0.40	---	---
S10-54-8B	8	9.6	184	3.33	0.31		---	---
Average				3.57	0.29		---	---

Metric Conversion: 1 ft. = .305 m, 1 kip = 4.448 kN, 1 in. = 25.4mm, 1 kip*in./rad. = 0.112 kN*m/rad.

¹ Assembly designation is as follows: the first letter “D” or “S” represents double or single L-section, the first number is the vertical leg dimension (in.) of the L-section(s), the second number is the nominal thickness of the L-section (in.), and the last number is the clear span (ft).

TABLE B11 – Double L-header Serviceability Proposed Prediction Equation

Assembly Designation ¹	Span <i>L</i> (ft.)	<i>L/h</i>	<i>h/t</i>	Effective Moment of Inertia <i>I_e</i> (in. ⁴)	Deflection at Service Load Level Δ_{ig} (in.)	<i>L/240</i> Limit (in.)	Proposed Prediction Equation		
							Equivalent Moment of Inertia <i>I_{eq}</i> (in. ⁴)	Deflection at Service Load Level Δ_{pg} (in.)	$\Delta_{ig} / \Delta_{pg}$
D6-33-3A ²	3	6	180	1.47	0.10	0.15	1.22	0.06	N/A
D6-33-3B ²	3	6	180	1.47	0.14	0.15	1.22	0.06	N/A
D6-43-3A ²	3	6	137	2.00	0.13	0.15	1.67	0.05	N/A
D6-43-3B ²	3	6	137	2.00	0.11	0.15	1.67	0.05	N/A
D6-43-3C ³	3	6	137	2.00	0.06 ³	0.15	1.67	0.05	1.19
D6-54-3A ²	3	6	111	2.56	0.15	0.15	2.13	0.06	N/A
D6-54-3B ²	3	6	111	2.56	0.16	0.15	2.13	0.05	N/A
D8-33-3A ²	3	4.5	235	3.39	0.09	0.15	2.45	0.04	N/A
D8-33-3B ²	3	4.5	235	3.39	0.10	0.15	2.45	0.03	N/A
D8-33-3C ³	3	4.5	235	3.39	0.05 ³	0.15	2.45	0.03	1.46
D8-43-3A ²	3	4.5	184	4.50	0.12	0.15	3.24	0.04	N/A
D8-43-3B ²	3	4.5	184	4.50	0.12	0.15	3.24	0.04	N/A
D8-43-3C ³	3	4.5	184	4.50	0.07 ³	0.15	3.24	0.04	1.96
D10-33-3A ²	3	3.6	293	6.45	0.10	0.15	4.16	0.02	N/A
D10-33-3B ²	3	3.6	293	6.45	0.10	0.15	4.16	0.02	N/A
D10-43-3A ²	3	3.6	230	8.49	0.12	0.15	5.48	0.02	N/A
D10-43-3B ²	3	3.6	230	8.49	0.13	0.15	5.48	0.02	N/A
D6-54-6A	6	12	111	2.56	0.24	0.30	3.01	0.24	0.99
D6-54-6B*	6	12	111	2.56	0.22	0.30	3.01	0.21	N/A
D6-54-6C	6	12	111	2.56	0.21	0.30	3.01	0.26	0.81
D8-43-6A	6	9	184	4.50	0.14	0.30	4.59	0.17	0.82
D8-43-6B	6	9	184	4.50	0.16	0.30	4.59	0.18	0.93

Metric Conversion: 1 ft. = .305 m, 1 in.⁴ = 416,231 mm⁴, 1 in. = 25.4mm

¹ Assembly designation is as follows: the first letter “D” or “S” represents double or single L-section, the first number is the vertical leg dimension (in.) of the L-section(s), the second number is the nominal thickness of the L-section (in.), and the last number is the clear span (ft).

² Deflection readings are of top track.

³ Retest – Deflection readings are of bottom track.

* Outlier, not included averages.

TABLE B11 cont. – Double L-header Serviceability Proposed Prediction Equation

Assembly Designation ¹	Span <i>L</i> (ft.)	<i>L/h</i>	<i>h/t</i>	Effective Moment of Inertia <i>I_e</i> (in. ⁴)	Deflection at Service Load Level Δ_{lg} (in.)	<i>L/240</i> Limit (in.)	Proposed Prediction Equation		
							Equivalent Moment of Inertia <i>I_{eq}</i> (in. ⁴)	Deflection at Service Load Level Δ_{pg} (in.)	$\Delta_{lg} / \Delta_{pg}$
D8-54-6A	6	9	148	5.73	0.15	0.30	5.85	0.16	0.97
D8-54-6B	6	9	148	5.73	0.16	0.30	5.85	0.17	0.92
D10-43-6A ⁴	6	7.2	230	8.49	N/A	0.30	7.75	0.12	N/A
D10-43-6B ⁴	6	7.2	230	8.49	N/A	0.30	7.75	0.13	N/A
D10-54-6A	6	7.2	185	10.8	0.15	0.30	9.85	0.12	1.19
D10-54-6B	6	7.2	185	10.8	0.16	0.30	9.85	0.13	1.21
D6-43-8A	8	16	137	2.02	0.38	0.40	2.75	0.44	0.85
D6-43-8B	8	16	137	2.02	0.42	0.40	2.75	0.43	0.98
D6-54-8A	8	16	110	2.58	0.40	0.40	3.51	0.44	0.90
D6-54-8B	8	16	110	2.58	0.41	0.40	3.51	0.42	0.97
D8-43-8A	8	12	183	4.55	0.27	0.40	5.35	0.30	0.90
D8-43-8B	8	12	183	4.55	0.25	0.40	5.35	0.31	0.81
D8-54-8A	8	12	147	5.78	0.30	0.40	6.81	0.30	0.98
D8-54-8B	8	12	147	5.78	0.34	0.40	6.81	0.29	1.16
D10-43-8A	8	9.6	228	8.59	0.22	0.40	9.04	0.22	0.98
D10-43-8B	8	9.6	228	8.59	0.21	0.40	9.04	0.23	0.92
D10-54-8A	8	9.6	184	10.9	0.20	0.40	11.5	0.22	0.90
D10-54-8B	8	9.6	184	10.9	0.25	0.40	11.5	0.22	1.15
D8-54-12A	12	18	147	5.78	0.57	0.60	8.34	0.58	0.99
D8-54-12B	12	18	147	5.78	0.53	0.60	8.34	0.58	0.91
D8-68-12A	12	18	115	7.68	0.64	0.60	11.1	0.61	1.05
D8-68-12B	12	18	115	7.68	0.61	0.60	11.1	0.63	0.98

Metric Conversion: 1 ft. = .305 m, 1 in.⁴ = 416,231 mm⁴, 1 in. = 25.4mm

¹ Assembly designation is as follows: the first letter “D” or “S” represents double or single L-section, the first number is the vertical leg dimension (in.) of the L-section(s), the second number is the nominal thickness of the L-section (in.), and the last number is the clear span (ft).

⁴ LMT not working correctly – deflection readings not appropriate

TABLE B11 cont. – Double L-header Serviceability Proposed Prediction Equation

Assembly Designation ¹	Span <i>L</i> (ft.)	<i>L/h</i>	<i>h/t</i>	Effective Moment of Inertia <i>I_e</i> (in. ⁴)	Deflection at Service Load Level Δ_{lg} (in.)	<i>L/240</i> Limit (in.)	Proposed Prediction Equation		
							Equivalent Moment of Inertia <i>I_{eq}</i> (in. ⁴)	Deflection at Service Load Level Δ_{pg} (in.)	$\Delta_{lg} / \Delta_{pg}$
D10-54-12A	12	14.4	184	10.9	0.42	0.60	14.0	0.49	0.85
D10-54-12B	12	14.4	184	10.9	0.46	0.60	14.0	0.49	0.94
D10-68-12A	12	14.4	144	14.5	0.47	0.60	18.7	0.46	1.02
D10-68-12B	12	14.4	144	14.5	0.48	0.60	18.7	0.45	1.06
D8-54-16A	16	24	148	5.77	0.86	0.80	9.60	0.96	0.90
D8-54-16B	16	24	148	5.77	0.91	0.80	9.60	0.95	0.96
D8-68-16A	16	24	115	7.72	1.02	0.80	12.9	0.99	1.03
D8-68-16B	16	24	115	7.72	1.03	0.80	12.9	0.96	1.08
D10-54-16A	16	19.2	185	10.9	0.59	0.80	16.2	0.67	0.88
D10-54-16B	16	19.2	185	10.9	0.61	0.80	16.2	0.68	0.89
D10-68-16A	16	19.2	143	14.5	0.75	0.80	21.5	0.71	1.05
D10-68-16B	16	19.2	143	14.5	0.75	0.80	21.5	0.71	1.06
								Average	0.97
								Standard Deviation	0.10
								COV	0.11

Metric Conversion: 1 ft. = .305 m, 1 in⁴ = 416,231 mm⁴, 1 in. = 25.4mm

¹ Assembly designation is as follows: the first letter “D” or “S” represents double or single L-section, the first number is the vertical leg dimension (in.) of the L-section(s), the second number is the nominal thickness of the L-section (in.), and the last number is the clear span (ft).

TABLE B12 – Single L-header Serviceability Proposed Prediction Equation

Assembly Designation ¹	Span L (ft.)	L/h	h/t	Effective Moment of Inertia I_e (in. ⁴)	Deflection at Service Load Level Δ_{lg} (in.)	$L/240$ Limit (in.)	Proposed Prediction Equation		
							Equivalent Moment of Inertia I_{eq} (in. ⁴)	Deflection at Service Load Level Δ_{pg} (in.)	$\Delta_{lg} / \Delta_{pg}$
S6-33-4A ²	4	8	180	0.74	0.14	0.20	0.59	0.11	N/A
S6-33-4B ²	4	8	180	0.74	0.15	0.20	0.59	0.12	N/A
S6-33-4C ³	4	8	180	0.74	0.07 ³	0.20	0.59	0.13	0.51
S6-43-4A ²	4	8	137	1.00	0.13	0.20	0.80	0.10	N/A
S6-43-4B ²	4	8	137	1.00	0.15	0.20	0.80	0.09	N/A
S6-43-4C*	4	8	137	1.00	0.18	0.20	0.80	0.12	N/A
S6-43-4D ²	4	8	137	1.00	0.15	0.20	0.80	0.11	N/A
S8-33-4A ²	4	6	235	1.70	0.13	0.20	1.02	0.08	N/A
S8-33-4B ²	4	6	235	1.70	0.14	0.20	1.02	0.08	N/A
S8-33-4C ²	4	6	235	1.70	0.09	0.20	1.02	0.08	N/A
S8-33-4D ²	4	6	235	1.70	0.12	0.20	1.02	0.08	N/A
S8-43-4A ²	4	6	184	2.25	0.17	0.20	1.35	0.09	N/A
S8-43-4B ²	4	6	184	2.25	0.14	0.20	1.35	0.08	N/A
S8-43-4C ²	4	6	184	2.25	0.13	0.20	1.35	0.08	N/A
S8-43-4D ³	4	6	184	2.25	0.06 ³	0.20	1.35	0.09	0.61
S8-54-4A ²	4	6	148	2.87	0.11	0.20	1.72	0.08	N/A
S8-54-4B ²	4	6	148	2.87	0.13	0.20	1.72	0.08	N/A
S10-33-4A ²	4	4.8	293	3.22	0.13	0.20	1.55	0.06	N/A
S10-33-4B ²	4	4.8	293	3.22	0.14	0.20	1.55	0.06	N/A
S10-33-4C ³	4	4.8	293	3.22	0.06	0.20	1.55	0.07	0.89

Metric Conversion: 1 ft. = .305 m, 1 in⁴ = 416,231 mm⁴, 1 in. = 25.4mm

¹ Assembly designation is as follows: the first letter “D” or “S” represents double or single L-section, the first number is the vertical leg dimension (in.) of the L-section(s), the second number is the nominal thickness of the L-section (in.), and the last number is the clear span (ft).

² Deflection readings are of top track.

³ Retest – Deflection readings are of bottom track.

* Outlier, not included averages.

TABLE B12 cont. – Single L-header Serviceability Proposed Prediction Equation

Assembly Designation ¹	Span <i>L</i> (ft.)	<i>L/h</i>	<i>h/t</i>	Effective Moment of Inertia <i>I_e</i> (in. ⁴)	Deflection at Service Load Level Δ_{ig} (in.)	<i>L/240</i> Limit (in.)	Proposed Prediction Equation		
							Equivalent Moment of Inertia <i>I_{eq}</i> (in. ⁴)	Deflection at Service Load Level Δ_{pg} (in.)	$\Delta_{ig} / \Delta_{pg}$
S10-54-4A ²	4	4.8	185	5.40	0.13	0.20	2.59	0.06	N/A
S10-54-4B ²	4	4.8	185	5.40	0.13	0.20	2.59	0.06	N/A
S10-54-4C ²	4	4.8	185	5.40	0.15	0.20	2.59	0.06	N/A
S10-54-4D ³	4	4.8	185	5.40	0.06 ³	0.20	2.59	0.07	0.85
S6-33-6A	6	12	180	0.74	0.15	0.30	0.88	0.26	0.57
S6-33-6B	6	12	180	0.74	0.16	0.30	0.88	0.26	0.63
S6-33-6C	6	12	180	0.74	0.20	0.30	0.88	0.26	0.75
S6-43-6A	6	12	137	1.00	0.20	0.30	1.20	0.22	0.92
S6-43-6B	6	12	137	1.00	0.17	0.30	1.20	0.26	0.66
S6-43-6C	6	12	137	1.00	0.10	0.30	1.20	0.36	0.26
S8-43-6A	6	9	184	2.25	0.18	0.30	2.02	0.16	1.15
S8-43-6B	6	9	184	2.25	0.17	0.30	2.02	0.19	0.87
S10-43-6A	6	7.2	230	4.25	0.16	0.30	3.06	0.15	1.07
S10-43-6B	6	7.2	230	4.25	0.15	0.30	3.06	0.16	0.94
S10-54-6A	6	7.2	185	5.40	0.22	0.30	3.89	0.15	1.39
S10-54-6B	6	7.2	185	5.40	0.20	0.30	3.89	0.16	1.24
S6-43-8A	8	16	137	1.01	0.44	0.40	1.62	0.42	1.05
S6-43-8B	8	16	137	1.01	0.45	0.40	1.62	0.41	1.10
S6-54-8A	8	16	110	1.29	0.43	0.40	2.06	0.39	1.11
S6-54-8B	8	16	110	1.29	0.38	0.40	2.06	0.38	1.00
S8-43-8A	8	12	183	2.27	0.30	0.40	2.73	0.33	0.89
S8-43-8B	8	12	183	2.27	0.32	0.40	2.73	0.32	1.01

Metric Conversion: 1 ft. = .305 m, 1 in.⁴ = 416,231 mm⁴, 1 in. = 25.4mm

¹ Assembly designation is as follows: the first letter “D” or “S” represents double or single L-section, the first number is the vertical leg dimension (in.) of the L-section(s), the second number is the nominal thickness of the L-section (in.), and the last number is the clear span (ft).

² Deflection readings are of top track.

³ Retest– Deflection readings are of bottom track.

TABLE B12 cont. – Single L-header Serviceability Proposed Prediction Equation

Assembly Designation ¹	Span L (ft.)	L/h	h/t	Effective Moment of Inertia I_e (in. ⁴)	Deflection at Service Load Level Δ_{lg} (in.)	$L/240$ Limit (in.)	Proposed Prediction Equation		
							Equivalent Moment of Inertia I_{eq} (in. ⁴)	Deflection at Service Load Level Δ_{pg} (in.)	$\Delta_{lg} / \Delta_{pg}$
S8-54-8A	8	12	147	2.89	0.36	0.40	3.47	0.34	1.06
S8-54-8B	8	12	147	2.89	0.36	0.40	3.47	0.34	1.06
S10-43-8A	8	9.6	228	4.29	0.24	0.40	4.12	0.27	0.90
S10-43-8B	8	9.6	228	4.29	0.25	0.40	4.12	0.27	0.90
S10-54-8A	8	9.6	184	5.44	0.26	0.40	5.22	0.28	0.93
S10-54-8B	8	9.6	184	5.44	0.31	0.40	5.22	0.25	1.26
								Average	0.98
								Standard Deviation	0.20
								COV	0.21

Metric Conversion: 1 ft. = .305 m, 1 in.⁴ = 416,231 mm⁴, 1 in. = 25.4mm

¹ Assembly designation is as follows: the first letter “D” or “S” represents double or single L-section, the first number is the vertical leg dimension (in.) of the L-section(s), the second number is the nominal thickness of the L-section (in.), and the last number is the clear span (ft).

TABLE B13 – Double L-header Flexural Test Data (Uplift Loads)

Header Designation ¹	Span <i>L</i> (ft.)	<i>L/h</i>	<i>h/t</i>	Ultimate Test Load <i>P_t</i> (kip)	Test Moment <i>M_{tu}</i> (kip*in.)	AISI – N.A. Specification (AISI S100-07)		AISI – Header Standard (AISI S212-07)	
						<i>M_{ng}</i> (kip*in.)	<i>M_{tu} / M_{ng}</i>	<i>M_{nu}</i> (kip*in.)	<i>M_{tu} / M_{nu}</i>
D6-43-3A_U ²	3	6.0	137	1.74	15.7	40.0	0.39	10.0 ²	1.57
D6-43-3B_U	3	6.0	139	1.94	17.4	36.8	0.47	9.20	1.90
Average				1.84	16.6		0.43		1.73
D6-54-3A_U	3	6.0	107	2.87	25.8	56.6	0.46	14.2	1.82
D6-54-3B_U	3	6.0	107	2.77	24.9	56.6	0.44	14.2	1.76
Average				2.82	25.4		0.45		1.79
D6-54-6A_U	6	12	107	2.08	25.0	56.6	0.44	14.2	1.76
D6-54-6B_U	6	12	107	1.92	23.0	56.6	0.41	14.2	1.63
Average				2.00	24.0		0.42		1.70
D6-43-8A_U	8	16	138	1.61	25.2	38.2	0.66	9.54	2.64
D6-43-8B_U	8	16	138	1.83	30.0	38.2	0.79	9.54	3.15
D6-43-8C_U	8	16	138	1.94	31.2	38.2	0.82	9.54	3.27
Average				1.79	28.8		0.75		3.02
D6-54-8A_U	8	16	111	2.46	40.4	52.8	0.77	13.2	3.06
D6-54-8B_U	8	16	111	2.36	38.4	52.8	0.73	13.2	2.90
Average				2.13	39.4		0.75		2.98
D8-33-3A_U	3	4.5	212	2.18	19.6	36.2	0.54	7.23	2.71
D8-33-3B_U	3	4.5	212	2.30	20.7	36.2	0.57	7.23	2.86
Average				2.24	20.1		0.56		2.78
D8-43-3A_U	3	4.5	185	2.66	23.9	60.7	0.39	12.1	1.97
D8-43-3B_U	3	4.5	185	2.47	22.2	60.7	0.37	12.1	1.83
Average				2.56			0.38		1.90

Metric Conversion: 1 ft = .305 m, 1 kip = 4.448 kN, 1 kip*in. = 0.112 kN*m

¹ Assembly designation is as follows: the first letter “D” or “S” represents double or single L-section, the first number is the vertical leg dimension (in.) of the L-section(s), the second number is the nominal thickness of the L-section (in.), and the last number is the clear span (ft).

² L-header material used was from the gravity loaded material – mechanical properties are different.

TABLE B13 cont. – Double L-header Flexural Test Data (Uplift Loads)

Header Designation ¹	Span <i>L</i> (ft.)	<i>L/h</i>	<i>h/t</i>	Ultimate Test Load <i>P_t</i> (kip)	Test Moment <i>M_{tu}</i> (kip*in.)	AISI – N.A. Specification (AISI S100-07)		AISI – Header Standard (AISI S212-07)	
						<i>M_{ng}</i> (kip*in.)	<i>M_{tu}</i> / <i>M_{ng}</i>	<i>M_{nu}</i> (kip*in.)	<i>M_{tu}</i> / <i>M_{nu}</i>
D8-43-6A_U	6	9.0	185	1.63	19.6	60.7	0.32	12.1	1.61
D8-43-6B_U	6	9.0	185	1.82	21.8	60.7	0.36	12.1	1.80
Average				1.72	20.7		0.34		1.70
D8-54-6A_U	6	9.0	143	2.85	34.3	92.6	0.37	23.1	1.48
D8-54-6B_U	6	9.0	143	2.95	35.4	92.6	0.38	23.1	1.53
Average				2.90	34.8		0.38		1.51
D8-54-8A_U*	8	12.0	148	2.93	46.7	86.4	0.54	21.6	2.16
D8-54-8B_U	8	12.0	148	3.30	52.7	86.4	0.61	21.6	2.44
D8-54-8C_U	8	12.0	148	3.58	58.2	86.4	0.67	21.6	2.69
Average				3.44	55.5		0.64		2.57
D8-54-12A_U	12	18.0	148	2.94	65.7	86.4	0.76	21.6	3.04
D8-54-12B_U	12	18.0	148	2.75	61.6	86.4	0.71	21.6	2.85
Average				2.84	63.7		0.74		2.95
D8-68-12A_U	12	18.0	114	3.32	73.2	119	0.62	29.6	2.47
D8-68-12B_U	12	18.0	114	3.04	67.9	119	0.57	29.6	2.29
Average				3.18	70.6		0.60		2.38
D8-54-16A_U	16	24.0	114	2.60	72.2	86.6	0.83	21.7	3.33
D8-54-16B_U	16	24.0	114	2.73	77.2	86.6	0.89	21.7	3.57
Average				2.67	74.7		0.86		3.45
D10-43-3A_U	3	3.6	231	3.36	30.3	90.4	0.33	16.3	1.86
D10-43-3B_U	3	3.6	231	3.35	30.1	90.4	0.33	16.3	1.85
Average				3.35	30.2		0.33		1.85
D10-54-3A_U	3	3.6	179	4.11	37.0	137	0.27	24.7	1.50
D10-54-3B_U	3	3.6	179	4.23	38.1	137	0.28	24.7	1.54
Average				4.17	37.5		0.27		1.52

Metric Conversion: 1 ft = .305 m, 1 kip = 4.448 kN, 1 kip*in. = 0.112 kN*m

¹ Assembly designation is as follows: the first letter “D” or “S” represents double or single L-section, the first number is the vertical leg dimension (in.) of the L-section(s), the second number is the nominal thickness of the L-section (in.), and the last number is the clear span (ft).

TABLE B13 cont. – Double L-header Flexural Test Data (Uplift Loads)

Header Designation ¹	Span L (ft.)	L/h	h/t	Ultimate Test Load P_t (kip)	Test Moment M_{tu} (kip*in.)	AISI – N.A. Specification (AISI S100-07)		AISI – Header Standard (AISI S212-07)	
						M_{ng} (kip*in.)	M_{tu} / M_{ng}	M_{nu} (kip*in.)	M_{tu} / M_{nu}
D10-54-6A_U	6	7.2	179	2.90	34.8	137	0.25	24.7	1.41
D10-54-6B_U	6	7.2	179	2.87	34.4	137	0.25	24.7	1.40
D10-54-6C_U ^{2*}	6	7.2	185	3.50	42.0	135	0.31	24.4	1.72
Average				3.09	37.1		0.27		1.51
D10-43-8A_U	8	9.6	230	2.61	42.5	93.8	0.45	16.9	2.51
D10-43-8B_U	8	9.6	230	2.72	45.0	93.8	0.48	16.9	2.64
Average				2.66	43.5		0.46		2.58
D10-54-8A_U	8	9.6	185	3.32	54.2	128	0.42	23.0	2.35
D10-54-8B_U	8	9.6	185	3.68	59.6	128	0.47	23.0	2.59
D10-54-8C_U	8	9.6	185	4.26	68.7	128	0.54	23.0	2.98
Average				3.75	60.8		0.48		2.64
D10-54-12A_U	12	14.4	185	3.51	76.7	128	0.60	25.6	3.00
D10-54-12B_U	12	14.4	185	3.56	78.7	128	0.61	25.6	3.07
Average				3.53	77.7		0.61		3.04
D10-68-12A_U	12	14.4	143	3.81	83.4	174	0.48	43.5	1.92
D10-68-12B_U	12	14.4	143	3.83	84.2	174	0.48	43.5	1.93
Average				3.82	83.8		0.48		1.93
D10-54-16A_U	16	19.2	186	2.95	81.6	128	0.64	25.7	3.18
D10-54-16B_U	16	19.2	186	2.88	80.5	128	0.63	25.7	3.14
D10-54-16C_U	16	19.2	186	3.08	86.7	128	0.68	25.7	3.38
Average				2.97	82.9		0.65		3.23
D10-68-16A_U	16	19.2	144	3.25	91.3	172	0.53	42.9	2.13
D10-68-16B_U	16	19.2	144	3.47	96.2	172	0.56	42.9	2.24
Average				3.36	93.7		0.55		2.19

Metric Conversion: 1 ft = .305 m, 1 kip = 4.448 kN, 1 kip*in. = 0.112 kN*m

¹ Assembly designation is as follows: the first letter “D” or “S” represents double or single L-section, the first number is the vertical leg dimension (in.) of the L-section(s), the second number is the nominal thickness of the L-section (in.), and the last number is the clear span (ft).

² L-header material used was from the gravity loaded material batch – mechanical properties are different.

* Outlier, not included in averages.

TABLE B14 – Single L-header Flexural Test Data (Uplift Loads)

Header Designation ¹	Span L (ft.)	L/h	h/t	Ultimate Test Load P_t (kip)	Test Moment M_{tu} (kip*in.)	AISI – N.A. Specification (AISI S100-07)	
						M_{ng} (kip*in.)	M_{tu}/M_{ng}
S6-33-4A_U	4	8	159	0.86	10.3	11.0	0.94
S6-33-4B_U	4	8	159	0.80	9.57	11.0	0.87
Average				0.83	9.94		0.90
S6-43-4A_U	4	8	139	0.98	11.8	18.4	0.64
S6-43-4B_U	4	8	139	0.71	8.51	18.4	0.46
Average				0.84	10.1		0.55
S6-43-6A_U	6	12	139	0.77	9.25	18.4	0.50
S6-43-6B_U	6	12	139	0.71	8.50	18.4	0.46
Average				0.74	8.88		0.48
S6-43-8A_U	8	16	137	1.11	18.5	18.8	0.99
S6-43-8B_U	8	16	137	1.15	19.3	18.8	1.03
Average				1.13	18.9		1.01
S6-54-8A_U	8	16	110	1.51	25.0	26.5	0.94
S6-54-8B_U	8	16	110	1.39	22.7	26.5	0.86
Average				1.45	23.9		0.90
S8-43-4A_U	4	6	185	1.21	14.5	30.4	0.48
S8-43-4B_U	4	6	185	1.20	14.4	30.4	0.48
Average				1.21	14.5		0.48
S8-54-4A_U	4	6	143	1.56	18.7	46.3	0.40
S8-54-4B_U*	4	6	143	1.24	14.9	46.3	0.32
S8-54-4C_U ²	4	6	148	1.60	19.2	45.6	0.42
Average				1.58	18.9		0.41
S8-43-6A_U	6	9	185	1.13	13.6	30.4	0.45
S8-43-6B_U	6	9	185	1.13	13.6	30.4	0.45
Average				1.13	13.6		0.45
S8-54-6A_U	6	9	143	1.18	14.2	46.3	0.31
S8-54-6B_U	6	9	143	1.19	14.3	46.3	0.31
S8-54-6C_U ^{2*}	6	9	148	1.68	20.2	45.6	0.44
Average				1.19	14.2		0.31
S8-43-8A_U	8	12	183	1.28	21.0	30.9	0.68
S8-43-8B_U	8	12	183	1.49	24.6	30.9	0.80
S8-43-8C_U	8	12	183	1.45	23.8	30.9	0.77
Average				1.41	23.2		0.75
S8-54-8A_U	8	12	147	1.83	30.2	43.3	0.70
S8-54-8B_U*	8	12	147	1.48	24.9	43.3	0.57
S8-54-8C_U	8	12	147	1.79	29.7	43.3	0.69
Average				1.81	29.9		0.70

Metric Conversion: 1 kip = 4.448 kN, 1 kip*in. = 0.112 kN*m

¹ Assembly designation is as follows: the first letter “D” or “S” represents double or single L-section, the first number is the vertical leg dimension (in.) of the L-section(s), the second number is the nominal thickness of the L-section (in.), and the last number is the clear span (ft).

² L-header material used was from the gravity loaded material batch – mechanical properties are different.

* Outlier, not included in averages.

TABLE B14 cont. – Single L-header Flexural Test Data (Uplift Loads)

Header Designation ¹	Span <i>L</i> (ft.)	<i>L/h</i>	<i>h/t</i>	Ultimate Test Load <i>P_t</i> (kip)	Test Moment <i>M_{tu}</i> (kip*in.)	AISI – N.A. Specification (AISI S100-07)	
						<i>M_{ng}</i> (kip*in.)	<i>M_{tu} / M_{ng}</i>
S10-33-4A_U	4	4.8	265	1.02	12.3	26.9	0.46
S10-33-4B_U	4	4.8	265	1.21	14.5	26.9	0.54
S10-33-4C_U ²	4	4.8	293	1.23	14.7	39.5	0.37
Average				1.15	13.8		0.46
S10-54-4A_U	4	4.8	179	1.76	21.2	68.5	0.31
S10-54-4B_U	4	4.8	179	1.91	23.0	68.5	0.34
Average				1.84	22.1		0.32
S10-54-6A_U	6	7.2	179	1.80	21.6	68.5	0.32
S10-54-6B_U	6	7.2	179	1.82	21.8	68.5	0.32
Average				1.81	21.7		0.32
S10-43-8A_U	8	9.6	228	1.59	26.4	46.0	0.57
S10-43-8B_U	8	9.6	228	1.65	27.5	46.0	0.60
Average				1.62	27.0		0.59

Metric Conversion: 1 kip = 4.448 kN, 1 kip*in. = 0.112 kN*m

¹ Assembly designation is as follows: the first letter “D” or “S” represents double or single L-section, the first number is the vertical leg dimension (in.) of the L-section(s), the second number is the nominal thickness of the L-section (in.), and the last number is the clear span (ft).

² L-header material used was from the gravity loaded material batch – mechanical properties are different.

* Outlier, not included in averages.

TABLE B15 – Double L-header Shear & Combined Flexure & Shear Check (Uplift Loads)

Header Designation ¹	Span <i>L</i> (ft.)	<i>L/h</i>	<i>h/t</i>	Ultimate Test Load <i>P_t</i> (kip)	Maximum Shear Force <i>V_t</i> (kip)	AISI – N.A. Specification (AISI S100-07)				Critical Section Forces		
						<i>k_v</i>	<i>F_v</i> (ksi)	<i>V_n</i> (kip)	<i>V_t / V_n</i>	<i>M_{t,crit}</i>	<i>V_{t,crit}</i>	Combined Check
D6-43-3A_U ²	3	6.0	137	1.74	0.87	5.59	7.77	4.08	0.21	15.7	0.87	0.45
D6-43-3B_U	3	6.0	139	1.94	0.97	5.59	7.63	3.97	0.24	17.4	0.97	0.53
D6-54-3A_U	3	6.0	107	2.87	1.43	5.59	12.8	8.58	0.17	25.8	1.43	0.44
D6-54-3B_U	3	6.0	107	2.77	1.38	5.59	12.8	8.58	0.16	24.9	1.38	0.42
D6-54-6A_U	6	12	107	2.08	1.04	5.59	12.8	8.58	0.12	25.0	1.04	0.39
D6-54-6B_U	6	12	107	1.92	0.96	5.59	12.8	8.58	0.11	23.0	0.96	0.36
D6-43-8A_U	8	16	138	1.61	0.86	5.59	7.70	4.02	0.21	20.6	0.86	0.54
D6-43-8B_U	8	16	138	1.83	0.93	5.59	7.70	4.02	0.23	22.3	0.93	0.58
D6-43-8C_U	8	16	138	1.94	0.97	5.59	7.70	4.02	0.24	23.3	0.97	0.61
D6-54-8A_U	8	16	111	2.46	1.23	5.59	11.9	7.73	0.16	29.6	1.23	0.49
D6-54-8B_U	8	16	111	2.36	1.18	5.59	11.9	7.73	0.15	28.3	1.18	0.47
D8-33-3A_U	3	4.5	212	2.18	1.09	5.78	3.37	2.03	0.54	19.3	1.09	0.86
D8-33-3B_U	3	4.5	212	2.30	1.15	5.78	3.37	2.03	0.57	20.7	1.15	0.91
D8-43-3A_U	3	4.5	185	2.66	1.33	5.78	4.44	3.08	0.43	23.9	1.33	0.67
D8-43-3B_U	3	4.5	185	2.47	1.23	5.78	4.44	3.08	0.40	22.2	1.23	0.62
D8-43-6A_U	6	9.0	185	1.63	0.82	5.78	4.44	3.08	0.26	19.6	0.82	0.46
D8-43-6B_U	6	9.0	185	1.82	0.91	5.78	4.44	3.08	0.30	21.8	0.91	0.51
D8-54-6A_U	6	9.0	143	2.85	1.43	5.78	7.43	6.66	0.21	34.3	1.43	0.44
D8-54-6B_U	6	9.0	143	2.95	1.48	5.78	7.43	6.66	0.22	35.4	1.48	0.45
D8-54-8A_U*	8	12.0	148	2.93	1.52	5.78	6.93	6.00	0.25	36.4	1.52	0.51
D8-54-8B_U	8	12.0	148	3.30	1.71	5.78	6.93	6.00	0.28	41.1	1.71	0.57
D8-54-8C_U	8	12.0	148	3.58	1.81	5.78	6.93	6.00	0.30	43.3	1.81	0.60
D8-54-12A_U	12	18.0	148	2.94	1.47	5.78	6.93	6.00	0.24	57.7	0.93	0.55
D8-54-12B_U	12	18.0	148	2.75	1.37	5.78	6.93	6.00	0.23	55.7	0.89	0.54

Metric Conversion: 1 kip = 4.448 kN, 1 kip*in. = 0.112 kN*m

¹ Assembly designation is as follows: the first letter “D” or “S” represents double or single L-section, the first number is the vertical leg dimension (in.) of the L-section(s), the second number is the nominal thickness of the L-section (in.), and the last number is the clear span (ft).

² L-header material used was from the gravity loaded material batch – mechanical properties are different.

* Outlier, not included in averages.

TABLE B15 cont. – Double L-header Shear & Combined Flexure & Shear Check (Uplift Loads)

Header Designation ¹	Span <i>L</i> (ft.)	<i>L/h</i>	<i>h/t</i>	Ultimate Test Load <i>P_t</i> (kip)	Maximum Shear Force <i>V_t</i> (kip)	AISI – N.A. Specification (AISI S100-07)				Critical Section Forces		
						<i>k_v</i>	<i>F_v</i> (ksi)	<i>V_n</i> (kip)	<i>V_t / V_n</i>	<i>M_{t,crit}</i>	<i>V_{t,crit}</i>	Combined Check
D8-68-12A_U	12	18.0	114	3.32	1.66	5.78	11.6	13.0	0.13	64.7	1.03	0.41
D8-68-12B_U	12	18.0	114	3.04	1.52	5.78	11.6	13.0	0.12	60.4	0.97	0.38
D8-54-16A_U	16	24.0	114	2.60	1.30	5.78	6.86	5.90	0.22	54.3	0.95	0.54
D8-54-16B_U	16	24.0	114	2.73	1.37	5.78	6.86	5.90	0.23	57.9	1.04	0.58
D10-43-3A_U	3	3.6	231	3.36	1.68	6.03	2.97	2.57	0.65	30.3	1.68	0.85
D10-43-3B_U	3	3.6	231	3.35	1.67	6.03	2.97	2.57	0.65	30.1	1.67	0.85
D10-54-3A_U	3	3.6	179	4.11	2.06	6.03	4.96	5.56	0.37	37.0	2.06	0.53
D10-54-3B_U	3	3.6	179	4.23	2.11	6.03	4.96	5.56	0.38	38.0	2.11	0.55
D10-54-6A_U	6	7.2	179	2.90	1.45	6.03	4.96	5.56	0.26	34.83	1.45	0.41
D10-54-6B_U	6	7.2	179	2.87	1.44	6.03	4.96	5.56	0.26	34.4	1.44	0.41
D10-54-6C_U ^{2*}	6	7.2	185	3.50	1.75	6.03	4.63	5.01	0.35	42.0	1.75	0.53
D10-43-8A_U	8	9.6	230	2.61	1.35	6.03	2.99	2.60	0.52	32.3	1.35	0.72
D10-43-8B_U	8	9.6	230	2.72	1.42	6.03	2.99	2.60	0.54	34.0	1.42	0.76
D10-54-8A_U	8	9.6	185	3.32	1.67	6.03	4.63	5.01	0.33	40.1	1.67	0.52
D10-54-8B_U	8	9.6	185	3.68	1.84	6.03	4.63	5.01	0.37	44.2	1.84	0.57
D10-54-8C_U	8	9.6	185	4.26	2.13	6.03	4.63	5.01	0.43	51.4	2.13	0.67
D10-54-12A_U	12	14.4	185	3.51	1.76	6.03	4.63	5.01	0.35	68.0	1.06	0.53
D10-54-12B_U	12	14.4	185	3.56	1.78	6.03	4.63	5.01	0.35	69.6	1.10	0.55
D10-68-12A_U	12	14.4	143	3.81	1.90	6.03	7.73	10.8	0.18	73.4	1.15	0.36
D10-68-12B_U	12	14.4	143	3.83	1.91	6.03	7.73	10.8	0.18	74.7	1.18	0.37
D10-54-16A_U	16	19.2	186	2.95	1.47	6.03	4.58	4.93	0.30	60.4	1.06	0.50
D10-54-16B_U	16	19.2	186	2.88	1.44	6.03	4.58	4.93	0.29	60.5	1.07	0.50
D10-54-16C_U	16	19.2	186	3.08	1.54	6.03	4.58	4.93	0.31	64.2	1.15	0.53
D10-68-16A_U	16	19.2	144	3.25	1.63	6.03	7.64	10.6	0.15	67.4	1.21	0.35
D10-68-16B_U	16	19.2	144	3.47	1.73	6.03	7.64	10.6	0.16	72.0	1.26	0.37

Metric Conversion: 1 ft = .305 m, 1 kip = 4.448 kN, 1 kip*in. = 0.112 kN*m

¹ Assembly designation is as follows: the first letter “D” or “S” represents double or single L-section, the first number is the vertical leg dimension (in.) of the L-section(s), the second number is the nominal thickness of the L-section (in.), and the last number is the clear span (ft).

² L-header material used was from the gravity loaded material batch – mechanical properties are different.

* Outlier, not included in averages.

TABLE B16 – Single L-header Shear & Combined Flexure & Shear Check (Uplift Loads)

Header Designation ¹	Span <i>L</i> (ft.)	<i>L/h</i>	<i>h/t</i>	Ultimate Test Load <i>P_t</i> (kip)	Maximum Shear Force <i>V_t</i> (kip)	AISI – N.A. Specification (AISI S100-07)				Critical Section Forces		
						<i>k_v</i>	<i>F_v</i> (ksi)	<i>V_n</i> (kip)	<i>V_t / V_n</i>	<i>M_{t_crit}</i>	<i>V_{t_crit}</i>	Combined Check
S6-33-4A_U	4	8	159	0.86	0.43	5.59	5.79	1.31	0.33	10.3	0.43	0.89
S6-33-4B_U	4	8	159	0.80	0.40	5.59	5.79	1.31	0.30	9.57	0.40	0.83
S6-43-4A_U	4	8	139	0.98	0.49	5.59	7.63	1.98	0.25	11.8	0.49	0.63
S6-43-4B_U	4	8	139	0.71	0.35	5.59	7.63	1.98	0.18	8.51	0.35	0.46
S6-43-6A_U	6	12	139	0.77	0.39	5.59	7.63	1.98	0.19	9.25	0.39	0.50
S6-43-6B_U	6	12	139	0.71	0.35	5.59	7.63	1.98	0.18	8.50	0.35	0.46
S6-43-8A_U	8	16	137	1.11	0.55	5.59	7.81	2.05	0.27	13.3	0.55	0.70
S6-43-8A_U	8	16	137	1.15	0.58	5.59	7.81	2.05	0.28	14.0	0.58	0.73
S6-54-8A_U	8	16	110	1.51	0.78	5.59	12.0	3.91	0.20	19.0	0.78	0.63
S6-54-8B_U	8	16	110	1.39	0.70	5.59	12.0	3.91	0.18	16.8	0.70	0.56
S8-43-4A_U	4	6	185	1.21	0.60	5.78	4.44	1.54	0.39	14.5	0.60	0.68
S8-43-4B_U	4	6	185	1.20	0.60	5.78	4.44	1.54	0.39	14.4	0.60	0.68
S8-54-4A_U	4	6	143	1.56	0.78	5.78	7.43	3.33	0.23	18.7	0.78	0.48
S8-54-4B_U*	4	6	143	1.24	0.62	5.78	7.43	3.33	0.19	14.9	0.62	0.38
S8-54-4C_U ²	4	6	148	1.60	0.80	5.78	6.93	3.00	0.27	19.2	0.80	0.52
S8-43-6A_U	6	9	185	1.13	0.57	5.78	4.44	1.54	0.37	13.6	0.57	0.64
S8-43-6B_U	6	9	185	1.13	0.57	5.78	4.44	1.54	0.37	13.6	0.57	0.64
S8-54-6A_U	6	9	143	1.18	0.59	5.78	7.43	3.33	0.18	14.2	0.59	0.36
S8-54-6B_U	6	9	143	1.19	0.59	5.78	7.43	3.33	0.18	14.3	0.59	0.36
S8-54-6C_U ²	6	9	148	1.68	0.84	5.78	6.93	3.00	0.28	20.2	0.84	0.54
S8-43-8A_U	8	12	183	1.28	0.65	5.78	4.55	1.59	0.41	15.6	0.65	0.71
S8-43-8B_U	8	12	183	1.49	0.76	5.78	4.55	1.59	0.48	18.2	0.76	0.83
S8-43-8C_U	8	12	183	1.45	0.73	5.78	4.55	1.59	0.46	17.4	0.73	0.79

Metric Conversion: 1 ft = .305 m, 1 kip = 4.448 kN, 1 kip*in. = 0.112 kN*m

¹ Assembly designation is as follows: the first letter “D” or “S” represents double or single L-section, the first number is the vertical leg dimension (in.) of the L-section(s), the second number is the nominal thickness of the L-section (in.), and the last number is the clear span (ft).

² L-header material used was from the gravity loaded material batch – mechanical properties are different.

* Outlier, not included in averages.

TABLE B16 cont. – Single L-header Shear & Combined Flexure & Shear Check (Uplift Loads)

Header Designation ¹	Span <i>L</i> (ft.)	<i>L/h</i>	<i>h/t</i>	Ultimate Test Load <i>P_t</i> (kip)	Maximum Shear Force <i>V_t</i> (kip)	AISI – N.A. Specification (AISI S100-07)				Critical Section Forces		
						<i>k_v</i>	<i>F_v</i> (ksi)	<i>V_n</i> (kip)	<i>V_t / V_n</i>	<i>M_{t,crit}</i>	<i>V_{t,crit}</i>	Combined Check
S8-54-8A_U	8	12	147	1.83	0.92	5.78	6.99	3.03	0.30	22.1	0.92	0.61
S8-54-8B_U*	8	12	147	1.48	0.75	5.78	6.99	3.03	0.25	17.9	0.75	0.49
S8-54-8C_U	8	12	147	1.79	0.90	5.78	6.99	3.03	0.30	21.7	0.90	0.60
S10-33-4A_U	4	4.8	265	1.02	0.51	6.03	2.25	0.85	0.60	12.3	0.51	0.88
S10-33-4B_U	4	4.8	265	1.21	0.60	6.03	2.25	0.85	0.71	14.5	0.60	1.04
S10-33-4C_U ²	4	4.8	293	1.23	0.61	6.03	1.84	0.63	0.98	14.7	0.61	1.20
S10-54-4A_U	4	4.8	179	1.76	0.88	6.03	4.96	2.78	0.32	21.2	0.88	0.50
S10-54-4B_U	4	4.8	179	1.91	0.96	6.03	4.96	2.78	0.34	23.0	0.96	0.55
S10-54-6A_U	6	7.2	179	1.80	0.90	6.03	4.96	2.78	0.32	21.6	0.90	0.51
S10-54-6B_U	6	7.2	179	1.82	0.91	6.03	4.96	2.78	0.33	21.8	0.91	0.52
S10-43-8A_U	8	9.6	228	1.59	0.80	6.03	3.03	1.33	0.60	19.2	0.80	0.85
S10-43-8B_U	8	9.6	228	1.65	0.83	6.03	3.03	1.33	0.63	20.0	0.83	0.89

Metric Conversion: 1 ft = .305 m, 1 kip = 4.448 kN, 1 kip*in. = 0.112 kN*m

¹ Assembly designation is as follows: the first letter “D” or “S” represents double or single L-section, the first number is the vertical leg dimension (in.) of the L-section(s), the second number is the nominal thickness of the L-section (in.), and the last number is the clear span (ft).

² L-header material used was from the gravity loaded material batch – mechanical properties are different.

* Outlier, not included in averages.

TABLE B17 – Double L-header Proposed Flexural Design Equation (Uplift Loads)

Header Designation ¹	Span <i>L</i> (ft.)	<i>L/h</i>	<i>h/t</i>	Test Moment <i>M_{tu}</i> (kip*in.)	Proposed Prediction Equation	
					<i>M_{ng}</i> (kip*in.)	<i>M_{ig} / M_{ng}</i>
D6-43-3A_U ²	3	6.0	137	15.7	14.0	1.12
D6-43-3B_U	3	6.0	139	17.4	12.9	1.35
D6-54-3A_U	3	6.0	107	25.8	19.8	1.30
D6-54-3B_U	3	6.0	107	24.9	19.8	1.26
D6-54-6A_U	6	12	107	25.0	28.3	0.88
D6-54-6B_U	6	12	107	23.0	28.3	0.81
D6-43-8A_U	8	16	138	25.2	23.7	1.06
D6-43-8B_U	8	16	138	30.0	23.7	1.26
D6-43-8C_U	8	16	138	31.2	23.7	1.31
D6-54-8A_U	8	16	111	40.4	32.9	1.23
D6-54-8B_U	8	16	111	38.4	32.9	1.17
D8-33-3A_U	3	4.5	212	19.6	12.7	1.55
D8-33-3B_U	3	4.5	212	20.7	12.7	1.63
D8-43-3A_U	3	4.5	185	23.9	21.2	1.13
D8-43-3B_U	3	4.5	185	22.2	21.2	1.04
D8-43-6A_U	6	9.0	185	19.6	24.4	0.80
D8-43-6B_U	6	9.0	185	21.8	24.4	0.89
D8-54-6A_U	6	9.0	143	34.3	37.2	0.92
D8-54-6B_U	6	9.0	143	35.4	37.2	0.95
D8-54-8A_U*	8	12.0	148	46.7	43.2	1.08
D8-54-8B_U	8	12.0	148	52.7	43.2	1.22
D8-54-8C_U	8	12.0	148	58.2	43.2	1.35
D8-54-12A_U	12	18.0	148	65.7	58.9	1.12
D8-54-12B_U	12	18.0	148	61.6	58.9	1.05
D8-68-12A_U	12	18.0	114	73.2	80.8	0.91
D8-68-12B_U	12	18.0	114	67.9	80.8	0.84
D8-54-16A_U	16	24.0	114	72.2	73.7	0.98
D8-54-16B_U	16	24.0	114	77.2	73.7	1.05
D10-43-3A_U	3	3.6	231	30.3	31.6	0.96
D10-43-3B_U	3	3.6	231	30.1	31.6	0.95
D10-54-3A_U	3	3.6	179	37.0	47.9	0.77
D10-54-3B_U	3	3.6	179	38.1	47.9	0.79
D10-54-6A_U	6	7.2	179	34.8	46.6	0.75
D10-54-6B_U	6	7.2	179	34.4	46.6	0.74
D10-54-6C_U ^{2*}	6	7.2	185	42.0	46.0	0.91
D10-43-8A_U	8	9.6	230	42.5	39.6	1.07
D10-43-8B_U	8	9.6	230	44.6	39.6	1.13
D10-54-8A_U	8	9.6	185	54.2	54.0	1.00
D10-54-8B_U	8	9.6	185	59.6	54.0	1.10
D10-54-8C_U	8	9.6	185	68.7	54.0	1.27
D10-54-12A_U	12	14.4	185	76.7	73.5	1.04
D10-54-12B_U	12	14.4	185	78.7	73.5	1.07

Metric Conversion: 1 ft. = .305 m, 1 kip*in. = 0.112 kN*m

¹ Assembly designation is as follows: the first letter “D” or “S” represents double or single L-section, the first number is the vertical leg dimension (in.) of the L-section(s), the second number is the nominal thickness of the L-section (in.), and the last number is the clear span (ft).

² L-header material used was from the gravity loaded material batch – mechanical properties are different.

* Outlier, not included in averages.

TABLE B17 cont. – Double L-header Prop. Flexural Design Equation (Uplift Loads)

Header Designation ¹	Span <i>L</i> (ft.)	<i>L/h</i>	<i>h/t</i>	Test Moment <i>M_{tu}</i> (kip*in.)	Proposed Prediction Equation	
					<i>M_{ng}</i> (kip*in.)	<i>M_{tg} / M_{ng}</i>
D10-68-12A_U	12	14.4	143	83.4	99.9	0.83
D10-68-12B_U	12	14.4	143	84.2	99.9	0.84
D10-54-16A_U	16	19.2	186	81.6	91.9	0.89
D10-54-16B_U	16	19.2	186	80.5	91.9	0.88
D10-54-16C_U	16	19.2	186	86.7	91.9	0.94
D10-68-16A_U	16	19.2	144	91.3	123	0.74
D10-68-16B_U	16	19.2	144	96.2	123	0.78
					Average	1.04
					Standard Deviation	0.21
					COV	0.20

Metric Conversion: 1 ft. = .305 m, 1 kip*in. = 0.112 kN*m

¹ Assembly designation is as follows: the first letter “D” or “S” represents double or single L-section, the first number is the vertical leg dimension (in.) of the L-section(s), the second number is the nominal thickness of the L-section (in.), and the last number is the clear span (ft).

TABLE B18 – Single L-header Proposed Flexural Design Equation (Uplift Loads)

Header Designation ¹	Span <i>L</i> (ft.)	<i>L/h</i>	<i>h/t</i>	Test Moment <i>M_{tu}</i> (kip*in.)	Proposed Prediction Equation	
					<i>M_{ng}</i> (kip*in.)	<i>M_{tg} / M_{ng}</i>
S6-33-4A_U	4	8	159	10.3	4.17	2.47
S6-33-4B_U	4	8	159	9.57	4.17	2.29
S6-43-4A_U	4	8	139	11.8	6.99	1.68
S6-43-4B_U	4	8	139	8.51	6.99	1.22
S6-43-6A_U	6	12	139	9.25	11.8	0.79
S6-43-6B_U	6	12	139	8.50	11.8	0.72
S6-43-8A_U	8	16	137	18.5	16.9	1.10
S6-43-8A_U	8	16	137	19.3	16.9	1.14
S6-54-8A_U	8	16	110	25.0	23.8	1.05
S6-54-8B_U	8	16	110	22.7	23.8	0.95
S8-43-4A_U	4	6	185	14.5	10.6	1.37
S8-43-4B_U	4	6	185	14.4	10.6	1.36
S8-54-4A_U	4	6	143	18.7	16.2	1.15
S8-54-4B_U*	4	6	143	14.9	16.2	0.92
S8-54-4C_U ²	4	6	148	19.2	16.0	1.20
S8-43-6A_U	6	9	185	13.6	13.5	1.01
S8-43-6B_U	6	9	185	13.6	13.5	1.00
S8-54-6A_U	6	9	143	14.2	20.6	0.69
S8-54-6B_U	6	9	143	14.3	20.6	0.69
S8-54-6C_U ²	6	9	148	20.2	20.3	0.99
S8-43-8A_U	8	12	183	21.0	19.8	1.06
S8-43-8B_U	8	12	183	24.6	19.8	1.24
S8-43-8C_U	8	12	183	23.8	19.8	1.20
S8-54-8A_U	8	12	147	30.2	27.7	1.09
S8-54-8B_U*	8	12	147	24.9	27.7	0.90
S8-54-8C_U	8	12	147	29.7	27.7	1.07
S10-33-4A_U	4	4.8	265	12.3	9.41	1.31
S10-33-4B_U	4	4.8	265	14.5	9.41	1.54
S10-33-4C_U ²	4	4.8	293	14.7	13.8	1.07
S10-54-4A_U	4	4.8	179	21.2	24.0	0.88
S10-54-4B_U	4	4.8	179	23.0	24.0	0.96
S10-54-6A_U	6	7.2	179	21.6	22.5	0.96
S10-54-6B_U	6	7.2	179	21.8	22.5	0.97
S10-43-8A_U	8	9.6	228	26.4	22.3	1.18
S10-43-8B_U	8	9.6	228	27.5	22.3	1.24
					Average	1.08
					Standard Deviation	0.22
					COV	0.21

Metric Conversion: 1 ft. = .305 m, 1 kip*in. = 0.112 kN*m

¹ Assembly designation is as follows: the first letter “D” or “S” represents double or single L-section, the first number is the vertical leg dimension (in.) of the L-section(s), the second number is the nominal thickness of the L-section (in.), and the last number is the clear span (ft).

² L-header material used was from the gravity loaded material batch – mechanical properties are different.

* Outlier, not included in averages.

TABLE B19 –Double L-header Deflection Test Data (Uplift Loads)

Assembly Designation ¹	Span L (ft.)	L/h	h/t	Load at L/240 (kip.)	Deflection at Service Load Level (in.)	L/240 Limit (in.)
D6-43-3A_U ²	3	6	137	1.04	0.16	0.15
D6-43-3B_U	3	6	139	1.49	0.09	
Average				1.27	0.13	
D6-54-3A_U	3	6	107	2.02	0.11	0.15
D6-54-3B_U	3	6	107	2.02	0.11	
Average				2.02	0.11	
D8-33-3A_U	3	4.5	212	1.71	0.09	0.15
D8-33-3B_U	3	4.5	212	1.56	0.10	
Average				1.64	0.10	
D8-43-3A_U	3	4.5	185	1.79	0.11	0.15
D8-43-3B_U	3	4.5	185	1.75	0.12	
Average				1.77	0.11	
D10-43-3A_U	3	3.6	231	2.44	0.10	0.15
D10-43-3B_U	3	3.6	231	2.14	0.13	
Average				2.29	0.12	
D10-54-3A_U	3	3.6	179	2.76	0.11	0.15
D10-54-3B_U	3	3.6	179	2.44	0.17	
Average				2.60	0.14	
D6-54-6A_U	6	12	107	1.60	0.17	0.30
D6-54-6B_U	6	12	107	1.43	0.21	
Average				1.52	0.19	
D8-43-6A_U	6	9	185	1.45	0.14	0.30
D8-43-6B_U	6	9	185	1.59	0.14	
Average				1.52	0.14	
D8-54-6A_U	6	9	143	2.30	0.16	0.30
D8-54-6B_U	6	9	143	2.26	0.18	
Average				2.28	0.17	
D10-54-6A_U	6	7.2	179	2.17	0.18	0.30
D10-54-6B_U	6	7.2	179	2.09	0.20	
D10-54-6C_U ^{2*}	6	7.2	185	2.53	0.13*	
Average				2.13	0.19	
D6-43-8A_U	8	16	138	1.00	0.46	0.40
D6-43-8B_U	8	16	138	1.09	0.39	
D6-43-8C_U	8	16	138	1.16	0.36	
Average				1.09	0.40	

Metric Conversion: 1 ft. = .305 m, 1 kip = 4.448 kN, 1 in. = 25.4 mm

¹ Assembly designation is as follows: the first letter “D” or “S” represents double or single L-section, the first number is the vertical leg dimension (in.) of the L-section(s), the second number is the nominal thickness of the L-section (in.), and the last number is the clear span (ft).

² L-header material used was from the gravity loaded material batch – mechanical properties are different.

* Outlier, not included in averages.

TABLE B19 cont. – Double L-header Deflection Test Data (Uplift Loads)

Assembly Designation ¹	Span L (ft.)	L/h	h/t	Load at L/240 (kip.)	Deflection at Service Load Level (in.)	L/240 Limit (in.)
D6-54-8A_U	8	16	111	1.29	0.49	0.40
D6-54-8B_U	8	16	111	1.41	0.42	
Average				1.35	0.45	
D8-54-8A_U*	8	12	148	1.77	0.62*	0.40
D8-54-8B_U	8	12	148	1.99	0.44	
D8-54-8C_U	8	12	148	2.05	0.41	
Average				2.02	0.42	
D10-43-8A_U	8	9.6	230	2.18	0.19	0.40
D10-43-8B_U	8	9.6	230	2.20	0.22	
Average				2.19	0.21	
D10-54-8A_U	8	9.6	185	2.38	0.36	0.40
D10-54-8B_U	8	9.6	185	2.62	0.28	
D10-54-8C_U	8	9.6	185	2.64	0.26	
Average				2.55	0.30	
D8-54-12A_U	12	18	148	1.84	0.52	0.60
D8-54-12B_U	12	18	148	1.64	0.65	
Average				1.74	0.58	
D8-68-12A_U	12	18	114	2.03	0.52	0.60
D8-68-12B_U	12	18	114	1.89	0.61	
Average				1.96	0.57	
D10-54-12A_U	12	14.4	185	2.37	0.47	0.60
D10-54-12B_U	12	14.4	185	2.39	0.45	
Average				2.38	0.46	
D10-68-12A_U	12	14.4	143	2.74	0.42	0.60
D10-68-12B_U	12	14.4	143	2.66	0.45	
Average				2.70	0.43	
D8-54-16A_U	16	24	114	1.55	0.85	0.80
D8-54-16B_U	16	24	114	1.56	0.84	
Average				1.55	0.84	
D10-54-16A_U	16	19.2	186	1.93	0.64	0.80
D10-54-16B_U	16	19.2	186	1.97	0.63	
D10-54-16C_U	16	19.2	186	2.05	0.60	
Average				1.98	0.62	
D10-68-16A_U	16	19.2	144	2.40	0.55	0.80
D10-68-16B_U	16	19.2	144	2.15	0.71	
Average				2.28	0.63	

Metric Conversion: 1 ft. = .305 m, 1 kip = 4.448 kN, 1 in. = 25.4 mm

¹ Assembly designation is as follows: the first letter “D” or “S” represents double or single L-section, the first number is the vertical leg dimension (in.) of the L-section(s), the second number is the nominal thickness of the L-section (in.), and the last number is the clear span (ft).

² L-header material used was from the gravity loaded material batch – mechanical properties are different.

* Outlier, not included in averages.

TABLE B20 – Single L-header Deflection Test Data (Uplift Loads)

Assembly Designation ¹	Span L (ft.)	L/h	h/t	Load at L/240 (kip.)	Deflection at Service Load Level (in.)	L/240 Limit (in.)
S6-33-4A_U	4	8	159	0.59	0.14	0.20
S6-33-4B_U	4	8	159	0.52	0.18	
Average				0.56	0.16	
S6-43-4A_U	4	8	139	0.61	0.15	0.20
S6-43-4B_U	4	8	139	0.49	0.21	
Average				0.55	0.18	
S8-43-4A_U	4	6	185	0.86	0.14	0.20
S8-43-4B_U	4	6	185	0.82	0.16	
Average				0.84	0.15	
S8-54-4A_U	4	6	143	1.00	0.15	0.20
S8-54-4B_U*	4	6	143	0.83	0.22*	
S8-54-4C_U ²	4	6	148	1.03	0.15	
Average				0.95	0.17	
S10-33-4A_U	4	4.8	265	0.72	0.18	0.20
S10-33-4B_U	4	4.8	265	0.79	0.15	
S10-33-4C_U ²	4	4.8	293	0.74	0.18	
Average				0.75	0.17	
S10-54-4A_U	4	4.8	179	1.18	0.18	0.20
S10-54-4B_U	4	4.8	179	1.39	0.13	
Average				1.28	0.15	
S6-43-6A_U	6	12	139	0.60	0.16	0.30
S6-43-6B_U	6	12	139	0.61	0.15	
Average				0.60	0.16	
S8-43-6A_U	6	9	185	0.89	0.14	0.30
S8-43-6B_U	6	9	185	0.96	0.13	
Average				0.92	0.13	
S8-54-6A_U	6	9	143	0.91	0.17	0.30
S8-54-6B_U	6	9	143	0.90	0.18	
S8-54-6C_U ^{2*}	6	9	148	1.18	0.11*	
Average				0.91	0.18	
S10-54-6A_U	6	7.2	179	1.45	0.14	0.30
S10-54-6B_U	6	7.2	179	1.46	0.13	
Average				1.45	0.14	
S6-43-8A_U	8	16	137	0.66	0.44	0.40
S6-43-8B_U	8	16	137	0.66	0.43	
Average				0.66	0.44	

Metric Conversion: 1 ft. = .305 m, 1 kip = 4.448 kN, 1 in. = 25.4 mm

¹ Assembly designation is as follows: the first letter “D” or “S” represents double or single L-section, the first number is the vertical leg dimension (in.) of the L-section(s), the second number is the nominal thickness of the L-section (in.), and the last number is the clear span (ft).

² L-header material used was from the gravity loaded material batch – mechanical properties are different.

* Outlier, not included in averages.

TABLE B20 cont. – Single L-header Deflection Test Data (Uplift Loads)

Assembly Designation ¹	Span <i>L</i> (ft.)	<i>L/h</i>	<i>h/t</i>	Load at <i>L/240</i> (kip.)	Deflection at Service Load Level (in.)	<i>L/240</i> Limit (in.)
S6-54-8A_U	8	16	110	0.76	0.53	0.40
S6-54-8B_U	8	16	110	0.70	0.57	
Average				0.73	0.55	
S8-43-8A_U	8	12	183	0.86	0.39	0.40
S8-43-8B_U*	8	12	183	0.89	0.36	
S8-43-8C_U	8	12	183	0.88	0.35	
Average				0.88	0.36	
S8-54-8A_U	8	12	147	1.06	0.41	0.40
S8-54-8B_U	8	12	147	0.94	0.54	
S8-54-8C_U	8	12	147	1.05	0.42	
Average				1.06	0.42	
S10-43-8A_U	8	9.6	228	1.19	0.27	0.40
S10-43-8B_U	8	9.6	228	1.17	0.27	
Average				1.18	0.27	

Metric Conversion: 1 ft. = .305 m, 1 kip = 4.448 kN, 1 in. = 25.4 mm

¹ Assembly designation is as follows: the first letter “D” or “S” represents double or single L-section, the first number is the vertical leg dimension (in.) of the L-section(s), the second number is the nominal thickness of the L-section (in.), and the last number is the clear span (ft).

² L-header material used was from the gravity loaded material batch – mechanical properties are different.

* Outlier, not included in averages.

TABLE B21 – Double L-header Serviceability Proposed Prediction Equation (Uplift Loads)

Assembly Designation ¹	Span L (ft.)	L/h	h/t	Effective Moment of Inertia I_e (in. ⁴)	Deflection at Service Load Level Δ_{tu} (in.)	$L/240$ Limit (in.)	Proposed Prediction Equation		
							Equivalent Moment of Inertia I_{eq} (in. ⁴)	Deflection at Service Load Level Δ_{pu} (in.)	$\Delta_{tu} / \Delta_{pu}$
D6-43-3A_U ²	3	6	137	2.00	0.16	0.15	0.34	0.10	1.62
D6-43-3B_U	3	6	139	1.99	0.09	0.15	0.34	0.11	0.81
D6-54-3A_U	3	6	107	2.67	0.11	0.15	0.45	0.13	0.88
D6-54-3B_U	3	6	107	2.67	0.11	0.15	0.45	0.12	0.90
D8-33-3A_U	3	4.5	212	3.94	0.09	0.15	0.37	0.12	0.76
D8-33-3B_U	3	4.5	212	3.94	0.10	0.15	0.37	0.12	0.85
D8-43-3A_U	3	4.5	185	4.49	0.11	0.15	0.43	0.12	0.90
D8-43-3B_U	3	4.5	185	4.49	0.12	0.15	0.43	0.11	1.01
D10-43-3A_U	3	3.6	231	8.48	0.10	0.15	0.42	0.16	0.65
D10-43-3B_U	3	3.6	231	8.48	0.13	0.15	0.42	0.16	0.84
D10-54-3A_U	3	3.6	179	11.3	0.11	0.15	0.56	0.14	0.78
D10-54-3B_U	3	3.6	179	11.3	0.17	0.15	0.56	0.15	1.11
D6-54-6A_U	6	12	107	2.67	0.17	0.30	1.25	0.22	0.74
D6-54-6B_U	6	12	107	2.67	0.21	0.30	1.25	0.21	1.01
D8-43-6A_U	6	9	185	4.49	0.14	0.30	1.44	0.15	0.93
D8-43-6B_U	6	9	185	4.49	0.14	0.30	1.44	0.17	0.79
D8-54-6A_U	6	9	143	5.98	0.16	0.30	1.91	0.20	0.78
D8-54-6B_U	6	9	143	5.98	0.18	0.30	1.91	0.21	0.84
D10-54-6A_U	6	7.2	179	11.3	0.18	0.30	2.59	0.15	1.22
D10-54-6B_U	6	7.2	179	11.3	0.20	0.30	2.59	0.15	1.34
D10-54-6C_U ^{2*}	6	7.2	185	10.8	0.13	0.30	2.48	0.19	N/A

Metric Conversion: 1 ft. = .305 m, 1 in.⁴ = 416,231 mm⁴, 1 in. = 25.4 mm

¹ Assembly designation is as follows: the first letter “D” or “S” represents double or single L-section, the first number is the vertical leg dimension (in.) of the L-section(s), the second number is the nominal thickness of the L-section (in.), and the last number is the clear span (ft).

² L-header material used was from the gravity loaded material batch – mechanical properties are different.

* Outlier, not included in averages.

TABLE B21 cont. – Double L-header Serviceability Proposed Prediction Equation (Uplift Loads)

Assembly Designation ¹	Span L (ft.)	L/h	h/t	Effective Moment of Inertia I_e (in. ⁴)	Deflection at Service Load Level Δ_{tu} (in.)	$L/240$ Limit (in.)	Proposed Prediction Equation		
							Equivalent Moment of Inertia I_{eq} (in. ⁴)	Deflection at Service Load Level Δ_{pu} (in.)	$\Delta_{tu} / \Delta_{pu}$
D6-43-8A_U	8	16	138	2.00	0.46	0.40	1.34	0.36	1.29
D6-43-8B_U	8	16	138	2.00	0.39	0.40	1.34	0.41	0.96
D6-43-8C_U	8	16	138	2.00	0.36	0.40	1.34	0.43	0.83
D6-54-8A_U	8	16	111	2.56	0.49	0.40	1.72	0.43	1.15
D6-54-8B_U	8	16	111	2.56	0.42	0.40	1.72	0.41	1.03
D8-54-8A_U*	8	12	148	5.76	0.62	0.40	2.71	0.32	N/A
D8-54-8B_U	8	12	148	5.76	0.44	0.40	2.71	0.36	1.20
D8-54-8C_U	8	12	148	5.76	0.41	0.40	2.71	0.39	1.04
D10-43-8A_U	8	9.6	230	8.50	0.19	0.40	2.98	0.27	0.71
D10-43-8B_U	8	9.6	230	8.50	0.22	0.40	2.98	0.28	0.79
D10-54-8A_U	8	9.6	185	10.8	0.36	0.40	3.79	0.26	1.38
D10-54-8B_U	8	9.6	185	10.8	0.28	0.40	3.79	0.29	0.96
D10-54-8C_U	8	9.6	185	10.8	0.26	0.40	3.79	0.33	0.79
D8-54-12A_U	12	18	148	5.76	0.52	0.60	4.44	0.62	0.84
D8-54-12B_U	12	18	148	5.76	0.65	0.60	4.44	0.59	1.10
D8-68-12A_U	12	18	114	7.74	0.52	0.60	5.96	0.52	1.01
D8-68-12B_U	12	18	114	7.74	0.61	0.60	5.96	0.48	1.29
D10-54-12A_U	12	14.4	185	10.8	0.47	0.60	6.40	0.51	0.92
D10-54-12B_U	12	14.4	185	10.8	0.45	0.60	6.40	0.52	0.88
D10-68-12A_U	12	14.4	143	14.5	0.42	0.60	8.54	0.41	1.02
D10-68-12B_U	12	14.4	143	14.5	0.45	0.60	8.54	0.42	1.07
D8-54-16A_U	16	24	149	5.72	0.85	0.80	6.12	0.90	0.94
D8-54-16B_U	16	24	149	5.72	0.84	0.80	6.12	0.95	0.88

Metric Conversion: 1 ft. = .305 m, 1 in.⁴ = 416,231 mm⁴, 1 in. = 25.4 mm

¹ Assembly designation is as follows: the first letter “D” or “S” represents double or single L-section, the first number is the vertical leg dimension (in.) of the L-section(s), the second number is the nominal thickness of the L-section (in.), and the last number is the clear span (ft).

² L-header material used was from the gravity loaded material batch – mechanical properties are different.

* Outlier, not included in averages.

TABLE B21 cont. – Double L-header Serviceability Proposed Prediction Equation (Uplift Loads)

Assembly Designation ¹	Span L (ft.)	L/h	h/t	Effective Moment of Inertia I_e (in. ⁴)	Deflection at Service Load Level Δ_{tu} (in.)	$L/240$ Limit (in.)	Proposed Prediction Equation		
							Equivalent Moment of Inertia I_{eq} (in. ⁴)	Deflection at Service Load Level Δ_{pu} (in.)	$\Delta_{tu} / \Delta_{pu}$
D10-54-16A_U	16	19.2	186	10.8	0.64	0.80	8.93	0.70	0.91
D10-54-16B_U	16	19.2	186	10.8	0.63	0.80	8.93	0.68	0.93
D10-54-16C_U	16	19.2	186	10.8	0.60	0.80	8.93	0.73	0.82
D10-68-16A_U	16	19.2	144	14.4	0.55	0.80	12.0	0.58	0.96
D10-68-16B_U	16	19.2	144	14.4	0.71	0.80	12.0	0.61	1.15
Average									0.97
Standard Deviation									0.20
COV									0.20

Metric Conversion: 1 ft. = .305 m, 1 in.⁴ = 416,231 mm⁴, 1 in. = 25.4 mm

¹ Assembly designation is as follows: the first letter “D” or “S” represents double or single L-section, the first number is the vertical leg dimension (in.) of the L-section(s), the second number is the nominal thickness of the L-section (in.), and the last number is the clear span (ft).

² L-header material used was from the gravity loaded material batch – mechanical properties are different.

* Outlier, not included in averages.

TABLE B22 – Single L-header Serviceability Proposed Prediction Equation (Uplift Loads)

Assembly Designation ¹	Span L (ft.)	L/h	h/t	Effective Moment of Inertia I_e (in. ⁴)	Deflection at Service Load Level Δ_{tu} (in.)	$L/240$ Limit (in.)	Proposed Prediction Equation		
							Equivalent Moment of Inertia I_{eq} (in. ⁴)	Deflection at Service Load Level Δ_{pu} (in.)	$\Delta_{tu} / \Delta_{pu}$
S6-33-4A_U	4	8	159	0.88	0.14	0.2	0.25	0.16	0.86
S6-33-4B_U	4	8	159	0.88	0.18	0.2	0.25	0.15	1.20
S6-43-4A_U	4	8	139	1.00	0.15	0.2	0.28	0.16	0.89
S6-43-4B_U	4	8	139	1.00	0.21	0.2	0.28	0.12	1.78
S8-43-4A_U	4	6	185	2.25	0.14	0.2	0.36	0.16	0.88
S8-43-4B_U	4	6	185	2.25	0.16	0.2	0.36	0.16	1.00
S8-54-4A_U	4	6	143	2.99	0.15	0.2	0.48	0.15	1.00
S8-54-4B_U*	4	6	143	2.99	0.22	0.2	0.48	0.12	N/A
S8-54-4C_U ²	4	6	148	2.87	0.15	0.2	0.46	0.16	0.91
S10-33-4A_U	4	4.8	265	3.71	0.18	0.2	0.33	0.15	1.20
S10-33-4B_U	4	4.8	265	3.71	0.15	0.2	0.33	0.17	0.87
S10-33-4C_U ²	4	4.8	293	3.22	0.18	0.2	0.28	0.20	0.87
S10-54-4A_U	4	4.8	179	5.62	0.18	0.2	0.49	0.17	1.06
S10-54-4B_U	4	4.8	179	5.62	0.13	0.2	0.49	0.18	0.69
S6-43-6A_U	6	12	139	1.00	0.16	0.3	0.52	0.20	0.79
S6-43-6B_U	6	12	139	1.00	0.15	0.3	0.52	0.18	0.83
S8-43-6A_U	6	9	185	2.25	0.14	0.3	0.76	0.20	0.68
S8-43-6B_U	6	9	185	2.25	0.13	0.3	0.76	0.20	0.66
S8-54-6A_U	6	9	143	2.99	0.17	0.3	1.02	0.16	1.11
S8-54-6B_U	6	9	143	2.99	0.18	0.3	1.02	0.16	1.17
S8-54-6C_U ^{2*}	6	9	148	2.87	0.11	0.3	0.97	0.23	N/A
S10-54-6A_U	6	7.2	179	5.62	0.14	0.3	1.30	0.19	0.77
S10-54-6B_U	6	7.2	179	5.62	0.13	0.3	1.30	0.19	0.70

Metric Conversion: 1 ft. = .305 m, 1 in.⁴ = 416,231 mm⁴, 1 in. = 25.4 mm

¹ Assembly designation is as follows: the first letter “D” or “S” represents double or single L-section, the first number is the vertical leg dimension (in.) of the L-section(s), the second number is the nominal thickness of the L-section (in.), and the last number is the clear span (ft).

² L-header material used was from the gravity loaded material batch – mechanical properties are different.

* Outlier, not included in averages.

TABLE B22 cont. – Single L-header Serviceability Proposed Prediction Equation (Uplift Loads)

Assembly Designation ¹	Span L (ft.)	L/h	h/t	Effective Moment of Inertia I_e (in. ⁴)	Deflection at Service Load Level Δ_{tu} (in.)	$L/240$ Limit (in.)	Proposed Prediction Equation		
							Equivalent Moment of Inertia I_{eq} (in. ⁴)	Deflection at Service Load Level Δ_{pu} (in.)	$\Delta_{tu} / \Delta_{pu}$
S6-43-8A_U	8	16	137	1.01	0.44	0.4	0.77	0.43	1.04
S6-43-8B_U	8	16	137	1.01	0.43	0.4	0.77	0.46	0.93
S6-54-8A_U	8	16	111	1.29	0.53	0.4	0.98	0.46	1.16
S6-54-8B_U	8	16	111	1.29	0.57	0.4	0.98	0.42	1.35
S8-43-8A_U	8	12	183	2.27	0.39	0.4	1.18	0.32	1.20
S8-43-8B_U	8	12	183	2.27	0.36	0.4	1.18	0.37	0.95
S8-43-8C_U	8	12	183	2.27	0.35	0.4	1.18	0.37	0.96
S8-54-8A_U	8	12	147	2.89	0.41	0.4	1.50	0.36	1.14
S8-54-8B_U*	8	12	147	2.89	0.54	0.4	1.50	0.29	N/A
S8-54-8C_U	8	12	148	2.89	0.42	0.4	1.50	0.35	1.20
S10-43-8A_U	8	9.6	228	4.29	0.27	0.4	1.61	0.29	0.91
S10-43-8B_U	8	9.6	228	4.29	0.27	0.4	1.61	0.31	0.89
								Average	0.99
								Standard Deviation	0.23
								COV	0.23

Metric Conversion: 1 ft. = .305 m, 1 in.⁴ = 416,231 mm⁴, 1 in. = 25.4 mm

¹ Assembly designation is as follows: the first letter “D” or “S” represents double or single L-section, the first number is the vertical leg dimension (in.) of the L-section(s), the second number is the nominal thickness of the L-section (in.), and the last number is the clear span (ft).

² L-header material used was from the gravity loaded material batch – mechanical properties are different.

* Outlier, not included in averages.



American Iron and Steel Institute

1140 Connecticut Avenue, NW
Suite 705
Washington, DC 20036
www.steel.org



Steel Framing Alliance™

Steel. The Better Builder.

1201 15th Street, NW
Suite 320
Washington, DC 20005
www.steel framing.org

