

research report

Steel Sheet Sheathing Options for CFS Framed Shear Wall Assemblies Providing Shear Resistance

RESEARCH REPORT RP07-3

2007



American Iron and Steel Institute



Steel Framing Alliance™

Steel. The Better Builder.

DISCLAIMER

The material contained herein has been developed by researchers based on their research findings and is for general information only. The information in it should not be used without first securing competent advice with respect to its suitability for any given application. The publication of the information is not intended as a representation or warranty on the part of the American Iron and Steel Institute, Steel Framing Alliance, or of any other person named herein, that the information is suitable for any general or particular use or of freedom from infringement of any patent or patents. Anyone making use of the information assumes all liability arising from such use.

PREFACE

The *North American Standard for Cold-Formed Steel Framing - Lateral Design*, AISI S213-07, provides design provisions for cold-formed steel framed shear walls with steel sheet sheathing. However, options are limited to 18-mil and 27-mil steel sheet sheathing. Presented in this report are the findings from an extensive monotonic and cyclic testing program conducted at the University of North Texas of 30-mil and 33-mil steel sheet sheathed shear walls with 2:1 and 4:1 aspect ratios and 27-mil sheet steel shear walls with 2:1 aspect ratio and 6-in., 4-in., 3-in., and 2-in. fastener spacing at panel edges.

It is anticipated that the results of this study will be incorporated in future standards developed by the AISI Committee on Framing Standards and design aids developed by the Cold-Formed Steel Engineers Institute.



**Steel Sheet Sheathing Options for Cold-Formed Steel Framed
Shear Wall Assemblies Providing Shear Resistance**

Report No. UNT-G76234

By

Cheng Yu, PhD – Project Director

Hitesh Vora, Tony Dainard, Jimmy Tucker, Pradeep Veetvkuri – Research Assistants

A Research Report Submitted to American Iron and Steel Institute

October 31, 2007

Department of Engineering Technology
University of North Texas
Denton, Texas 76207

ABSTRACT

In cold-formed steel construction, stud walls covered with steel sheet sheathing is an available option to resist lateral loads such as those caused by wind and earthquakes. The current American Iron and Steel Institute (AISI) Standard for Cold-Formed Steel Framing – Lateral Design 2004 Edition provides nominal shear strength for a limited range of steel sheet sheathed shear wall configurations. This report presents a research project developed to add values for 0.030-in. and 0.033-in. steel sheet sheathed shear walls with 2:1 and 4:1 aspect ratios and 0.027-in. sheet steel shear walls with 2:1 aspect ratio and 6-in., 4-in., 3-in., and 2-in. fastener spacing at panel edges. For all specimen configurations, the steel sheet sheathing was installed on one face of the wall. The test program consisted of two series of shear wall tests. The first series focused on determining the nominal shear strength for wind loads for which monotonic tests in accordance with ASTM E564 standard were performed. The second series of tests addressed the nominal shear strength for seismic loads for which the reversed cyclic tests using CUREE protocol were conducted. The research was sponsored by AISI and SSMA, and was performed at University of North Texas.

Table of Contents

Background and Objectives	1
Work Scope	2
Test Program	3
Test Setup.....	3
Test Procedure.....	6
Test Specimens - Main Group.....	7
Test Specimens - Supporting Group.....	15
Test Results	18
Shear Wall Tests for Specimens in Main Group.....	18
Shear Wall Tests for Specimens in Supporting Group.....	26
Material Properties.....	30
Discussion and Design Examples	31
Nominal Shear Strength.....	31
Reduction Factor.....	34
Comparison with the Test Results of other Researchers.....	41
Design Examples.....	43
Conclusions and Future Research	49
Acknowledgement	50
References	50
Appendix A Data Sheets of Monotonic Tests (Main Group)	52
Appendix B Data Sheets of Cyclic Tests (Main Group)	83
Appendix C Data Sheets of Additional Tests (Supporting Group)	127
Appendix D Quality Control Process	137

BACKGROUND AND OBJECTIVES

The research on the cold-formed steel framed shear walls with sheet steel sheathing is limited. In the past, Dr. Reynaud Serrette and his research team conducted series of tests on cold-formed steel framed walls with sheet steel sheathing on one side. In his test program reported in 1997 (Serrette 1997), both monotonic and cyclic tests were conducted on 0.018-in. and 0.027-in. steel sheet sheathed shear walls. The test protocol used for monotonic tests in Serrette’s tests was similar to ASTM E564 “Standard Practice for Static Load Test for Shear Resistance of Framed Walls for Buildings.” except the incremental loading procedure in Serrette’s work was based on the lateral top of wall displacement while ASTM E564 uses the estimated peak load to determine the load increments. For the cyclic tests, the sequential phase displacement (SPD) protocol was used in Serrette’s tests. The SPD consists of 72 cycles with a maximum displacement of 2.8 in.

Table 1 summarizes the test matrix and results of Serrette’s work in 1997 on the sheet steel shear walls. The nominal shear strength as tabulated in Table 1 was based on the average peak loads from the stabilized backbone curves for cyclic tests and the peak loads for monotonic tests. The failure mode varied for different specimen configurations. In general, for wall assemblies with fasteners spaced further apart, sheathing fastener pull-out and significant deformation of sheathing were observed. For the wall assemblies with fasteners spaced closer together, failure mode was buckling in the sheathing as well as in the studs.

The results reported in Serrette (1997) were used to update and expand the design data in the 1997 Uniform Building Code (UBC), and were included in the 2000 International Building Code (IBC), and American Iron and Steel Institute (AISI) Standard for Cold-Formed Steel Framing – Lateral Design 2004 Edition. Coupon tests on material properties were not reported in Serrette (1997).

Table 1 Test matrix and results of steel sheet shear walls in Serrette 1997

Monotonic Tests				
Configuration	Sheathing Thickness (in.)	#8 Screw Spacing edge (in.)/field(in.)	Wall Aspect Ratio (h:w)	Nominal Shear Strength (plf)
1	0.018	6/12	4:1 (8 ft × 2 ft)	491
2	0.018	6/12	2:1 (8 ft × 4 ft)	483
3	0.027	4/12	4:1 (8 ft × 2 ft)	990
Cyclic Tests				
1	0.018	6/12	2:1 (8 ft × 4 ft)	392
2	0.027	4/12	4:1 (8 ft × 2 ft)	1003
3	0.027	2/12	4:1 (8 ft × 2 ft)	1171
All specimens used nominal 33 ksi yield strength material, SSMA 350S162-33 studs, SSMA 350T125-33 track, and No.8 × ½-inch self-drilling screws.				

In 2002, Serrette performed cyclic tests on 0.027-in. sheet steel shear walls with simple lap shear connections at the adjoining panel edges. The overall dimensions of the wall assemblies were 4-ft. × 8-ft. and the sheathing was made by two 4-ft. × 4-ft. $\frac{3}{4}$ -in. sheets connected by single line of fasteners. No. 8 self-drilling screws were used to assemble the shear walls and the screws were installed at 2-in. o.c. on the edges and 12-in. o.c. in the field of the sheathing sheets. The nominal shear strength from this particular wall configuration was 787 pound per linear foot (plf). The mode of failure was pullout of the screws from the sheathing along the lap joint of the two sheets.

The current AISI Lateral Standard (2004) provides a limited range of nominal shear strengths for both wind loads and seismic loads for sheet steel shear walls. The published shear strengths are based on the research conducted by Dr. Reynaud Serrette and his team at Santa Clara University in 1997 and 2002 and only cover 0.018-in. and 0.027-in. sheet steel walls with a limitation of up to a 2:1 aspect ratio for the 0.018-in. steel sheet sheathing and up to a 4:1 aspect ratio for 0.027-in. steel sheet sheathing. Therefore additional tests were desired to address a wider range of options of steel sheet sheathing for cold-formed steel shear walls.

The objective of the research reported here was to develop experimental data and produce nominal shear strengths for both wind loads and seismic loads for cold-formed steel framed shear wall assemblies with 0.033-in., 0.030-in., or 0.027-in. steel sheathing on one side. The specific goals were to determine the nominal shear strength for:

- 0.030-in and 0.033-in. steel sheet shear walls with 2:1 and 4:1 aspect ratios (height/width) for both wind loads and seismic loads,
- 0.027-in. steel sheet shear walls with 2:1 aspect ratio for both wind loads and seismic loads.
- Fastener spacing of 6-in., 4-in., 3-in., and 2-in. at panel edges for all wall configurations of interest.

WORK SCOPE

The research project primarily involves two series of shear wall tests (referred as main group): the monotonic tests to obtain shear strengths for wind loads and the reversed cyclic tests to determine shear strengths for seismic loads. The monotonic tests conform to the ASTM E564-06 “Standard Practice for Static Load Test for Shear Resistance of Framed Walls for Buildings.” The reversed cyclic tests use the CUREE (Consortium of Universities for Research in Earthquake Engineering) protocol in accordance with ICC-ES AC130 “Acceptance Criteria for prefabricated Wood Shear Panels” (2004).

At the early stage of this project, five additional shear wall tests and three axial compression tests on wall assemblies were also performed to determine the fastener size and the fastener installation pattern used for the main group specimens. At the end of this project, one additional cyclic test was performed to investigate the option of using thicker steel framing in a 27-mil steel sheet sheathed shear wall assembly. Those additional tests are referred as the supporting group in this report. Coupon tests were also conducted to obtain the material properties of the shear wall assembly members.

TEST PROGRAM

The test program was carried out during the time period from February to August 2007 in the NUCONSTEEL Materials Testing Laboratory at University of North Texas, Denton Texas. A total of 33 monotonic shear wall tests, 33 cyclic shear wall tests, and 3 compression tests were conducted. The following sections provide the details of the test setup, testing procedure, and the test matrix.

Test Setup

The monotonic tests and the cyclic tests were performed on a 16-ft. span, 12-ft. high adaptable structural steel testing frame. Figure 1 shows the front view of the testing frame with a 4-ft. × 8-ft. steel shear wall and Figure 2 shows the back view of the frame. Figure 3 illustrates the schematic of the test setup. All the shear wall specimens were assembled in a horizontal position and then installed vertically in the testing frame. The wall is bolted to the base beam and loaded horizontally at the top. The base beam was 5-in. × 5-in. × ½-in. thickness structural steel tubing and that was attached to a W16×67 structural steel beam that was attached to the concrete floor slab with ¾-in. anchor bolts at 24-in. on center. The web of the structural steel tubing base beam was cut-out in several locations on one side to provide access to anchor bolts.

The out-of-plane (OOP) displacement of the wall was prevented by a series of steel rollers on the front side and three individual rollers on the back side of the wall top. A gap of approximately 1/8-in. was provided between the rollers on each side to the top of the wall. The rollers also worked as a guide for the loading beam “T” shape as shown in Figure 4. The “T” shape was attached to the top track member of the wall by 2 - No. 12 × 1-1/2-in. hex washer head (HWH) self-drilling tapping screws placed every 3-in. on center. The “T” shape was made to be 4.5-in. wide so that it prevents the rollers from touching the test specimens during the test. The anchorage system for monotonic tests consisted of three Grade 8 1/2-in. diameter shear anchor bolts with standard cut washers (reference ASME B18.22.1 (R 1998)) and one Simpson Strong-Tie® S/HD10S hold-down with one Grade 8 1/2-in. diameter anchor bolt. For the cyclic tests, the anchorage system included two Grade 8 1/2-in. diameter shear anchor bolts and one Simpson Strong-Tie® S/HD10S hold-down with a Grade 8 1/2-in. diameter hold-down anchor bolt at each end of the shear wall.

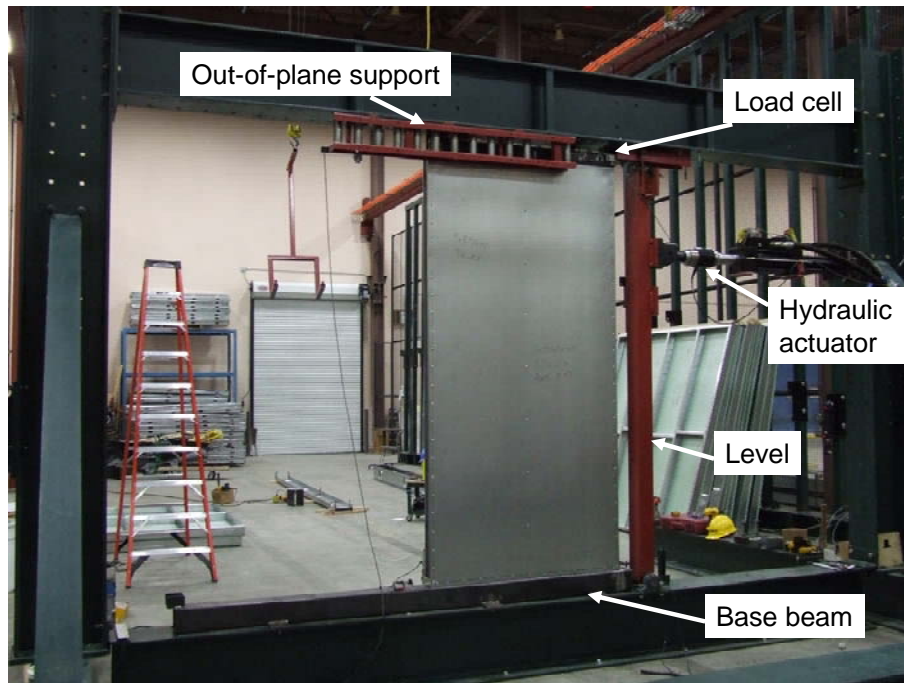

Figure 1 Front view of the test setup



Figure 2 Back view of the test setup

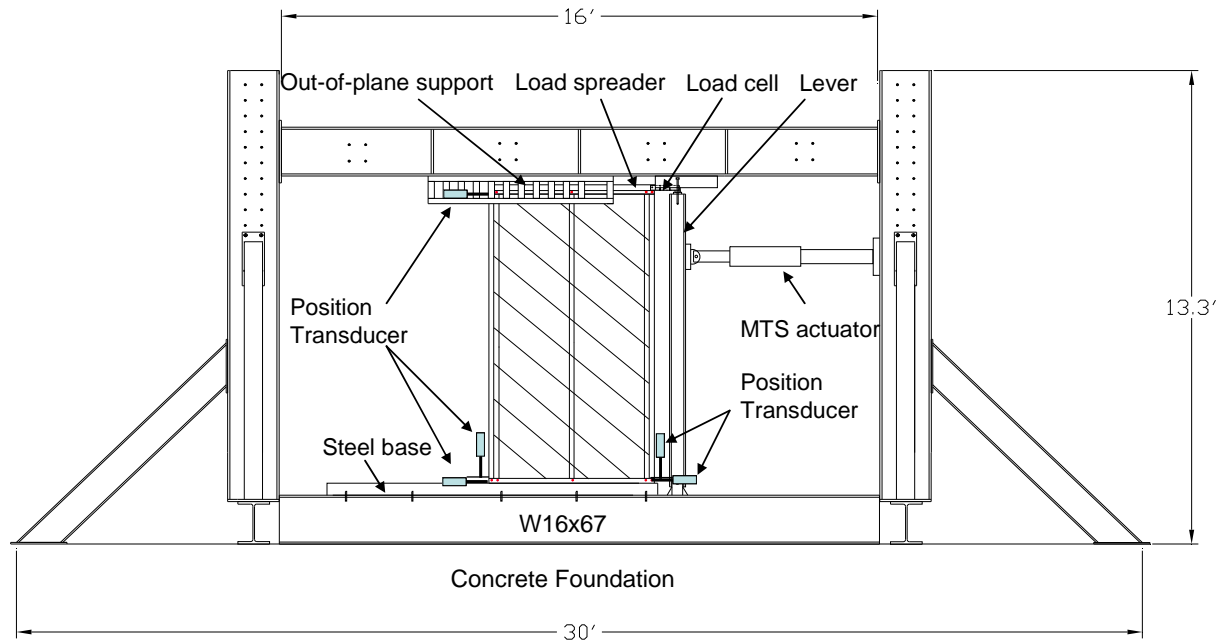

Figure 3 Testing frame with a 4-ft. × 8-ft. wall assembly

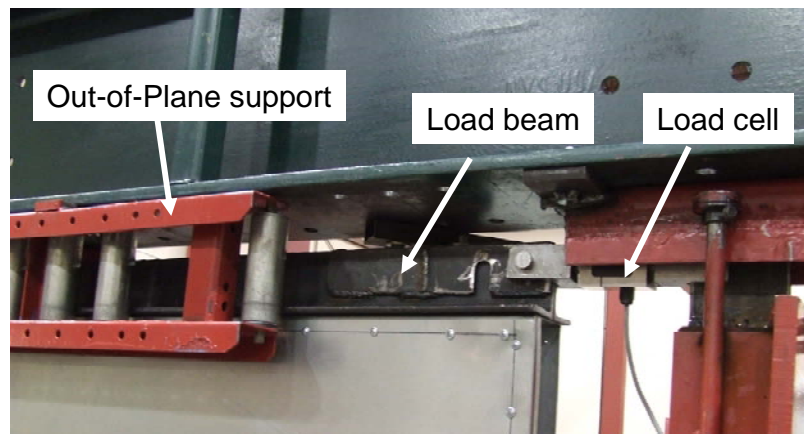

Figure 4 Close up of the top of the wall specimen

The testing frame was equipped with one MTS[®] 35-kip hydraulic actuator with ± 5 -in. stroke. A MTS[®] 407 controller and one 7-GPM MTS[®] hydraulic power unit were employed to support the loading system. Due to the limited capacity of the hydraulic power unit, a lever made by 4-in. \times 4-in. \times 1/4-in thickness square structural steel tubing was used to improve the performance of the hydraulic actuator. A 10-kip TRANSDUCER TECHNIQUES[®] SWO universal compression/tension load cell was placed to connect the top of lever to the “T” shape for force measuring. Five NOVOTECHNIC[®] position transducers were employed to measure the horizontal displacement at the top of wall, the vertical displacement of the two boundary studs, and the horizontal displacements of the bottom of the two boundary studs, as shown in Figure 3. The data acquisition system consisted of a National Instruments[®] unit (including a

PCI6225 DAQ card, a SCXI1100 chassis with SCXI1520 load cell sensor module and SCXI1540 LVDT input module) and an IBM® desktop. The applied force and the five displacements were measured and recorded instantaneously during the test.

Test Procedure

Both the monotonic and the cyclic tests were conducted in a displacement control mode. The procedure of the monotonic tests was in accordance with ASTM E564-06 “Standard Practice for Static Load Test for Shear Resistance of Framed Walls for Buildings”. A preload of approximately 10% of the estimated ultimate load was applied first to the specimen and held for 5 minutes to seat all connections. After the preload was removed, the incremental loading procedure started until failure using a load increment of 1/3 of the estimated ultimate load.

The CUREE protocol, in accordance with ICC-ES AC130 (2004), was chosen for the reversed cyclic tests. The CUREE basic loading history shown in Figure 5 includes 40 cycles with specific displacement amplitudes, which are listed in Table 2. The specified displacement amplitudes are based on a percentage of the ultimate displacement capacity determined from the monotonic tests. The ultimate displacement capacity is defined as a portion (i.e. $\gamma=0.60$) of maximum inelastic response, Δ_m , which corresponds to the displacement at 80% peak load. However, the CUREE protocol was originally developed for wood frame structures, and it was found in this test program that using $0.60\Delta_m$ as the reference displacement was not large enough to capture the post peak behavior of the sheet steel walls in the cyclic test. Therefore, the lesser of 2.5% of the wall height (2.4-in. for 8 ft. high wall) and the displacement at the peak load in the monotonic tests was used as the reference displacement in the CUREE protocol. A constant cycling frequency of 0.2-Hz (5 seconds) for the CUREE loading history was adopted for all the cyclic tests in this research.

Table 2 CUREE basic loading history

CYCLE NO.	% Δ	CYCLE NO.	% Δ
1	5.0	21	20
2	5.0	22	15
3	5.0	23	15
4	5.0	24	15
5	5.0	25	30
6	5.0	26	23
7	7.5	27	23
8	5.6	28	23
9	5.6	29	40
10	5.6	30	30
11	5.6	31	30
12	5.6	32	70
13	5.6	33	53
14	10	34	53
15	7.5	35	100
16	7.5	36	75
17	7.5	37	75
18	7.5	38	150
19	7.5	39	113
20	7.5	40	113

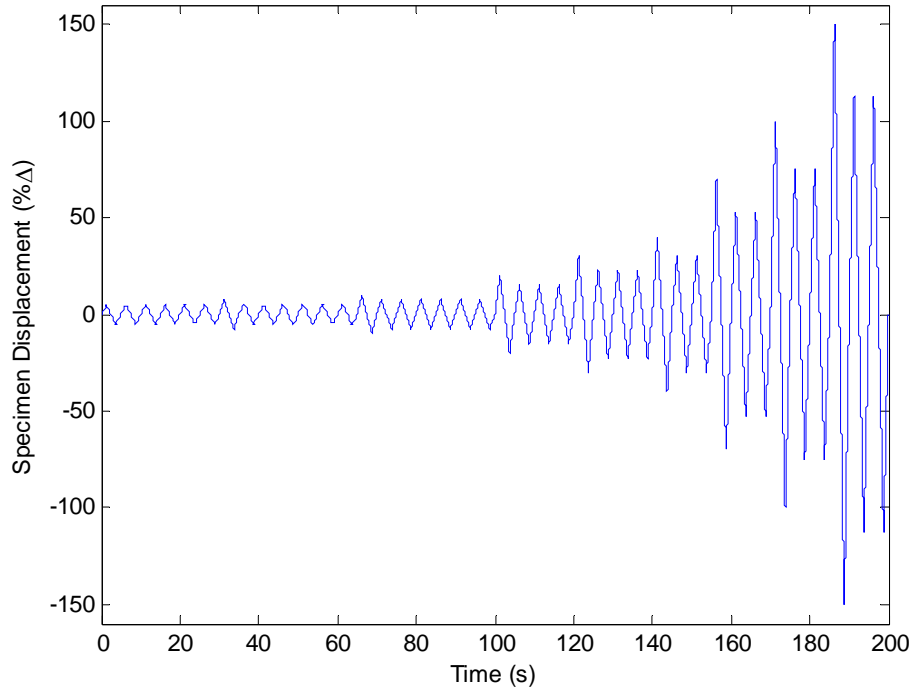

Figure 5 CUREE basic loading history (0.2 Hz)

Test Specimens - Main Group

The main group of the test specimens was designed to add nominal shear strength values of sheet steel sheathed shear wall assemblies to the AISI Lateral Standard (2004). The test matrix covered two overall wall dimensions: 8-ft. (wide) \times 4-ft. (high) (2:1 aspect ratio) and 8-ft. \times 2-ft. (4:1 aspect ratio); three sheet steel thicknesses: 0.033-in., 0.030-in., 0.027-in.; and three fastener spacing schedules on the panel edges: 6-in., 4-in., and 2-in. The 3-in. spacing configuration was not included in the main group as the nominal shear strength corresponding to 3-in. fastener spacing will be determined by interpolating the test results of the other spacing configurations.

Figures 6 and 7 show the dimensions of the sheathed steel framed shear wall, shear anchor bolts, and the hold-downs. The framing members were assembled using No. 8 \times 18-1/2" modified truss head self-drilling screws. Double C-shaped studs (back-to-back) were used for both boundary studs of the wall and the webs of the double studs were stitched together using 2 - No. 8 \times 18-1/2" modified truss head self-drilling screws spaced at 6 in. o.c. 43-mil (0.043-in.) and 33-mil (0.033-in.) SSMA (Steel Stud Manufacturers Association) standard framing members were chosen for the wall assemblies. For the monotonic test, one Simpson Strong-Tie[®] S/HD10S hold-down was attached to the tension boundary stud from inside by using a total of 15 - No. 14 \times 1" HWH self-drilling screws. For the cyclic test, one Simpson Strong-Tie[®] S/HD10S hold-down was used at each end of the wall, and 15 - No. 14 \times 1" HWH self-drilling screws were used to attach each hold-down to the boundary studs. In the tests, the punchouts at the hold-down locations were not covered by patch plates therefore the number of screws used for hold-downs was reduced to 15. It was calculated that the 15 screws would

provide enough strength against the expected uplift forces in the tests. For all specimens, the hold-down was raised 1.5-in. above the flange of the bottom track.

Three sheet steel sheathing thicknesses were investigated in this research: 27-mil, 30-mil and 33-mil. It was found that the steel sheets that were stamped 27-mil actually had a thickness comparable to the next larger 30-mil designation thickness. Therefore the materials were replaced by ones more closely matching the desired thickness. Material thicknesses for sheet steel sheathing and framing members were monitored throughout this test program. Also the material strengths were obtained by coupon tests on the untested materials at the end of this test program.

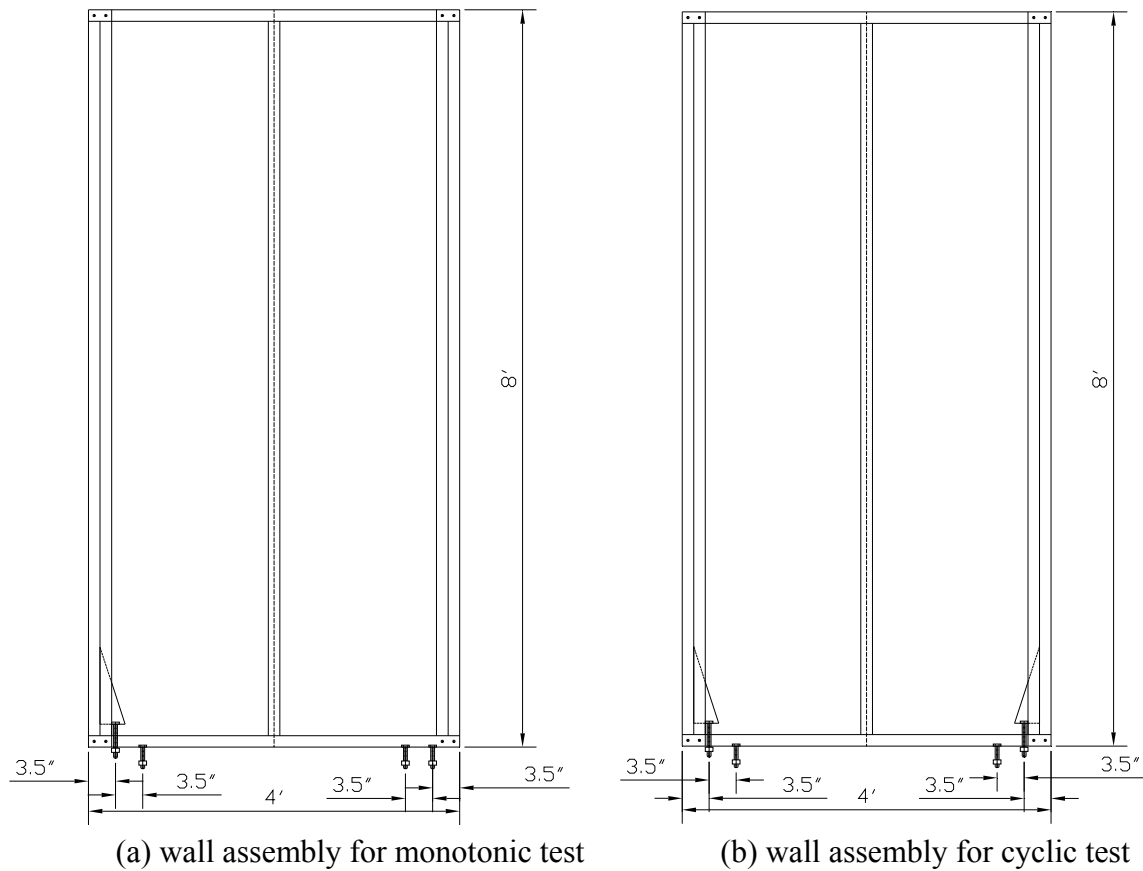

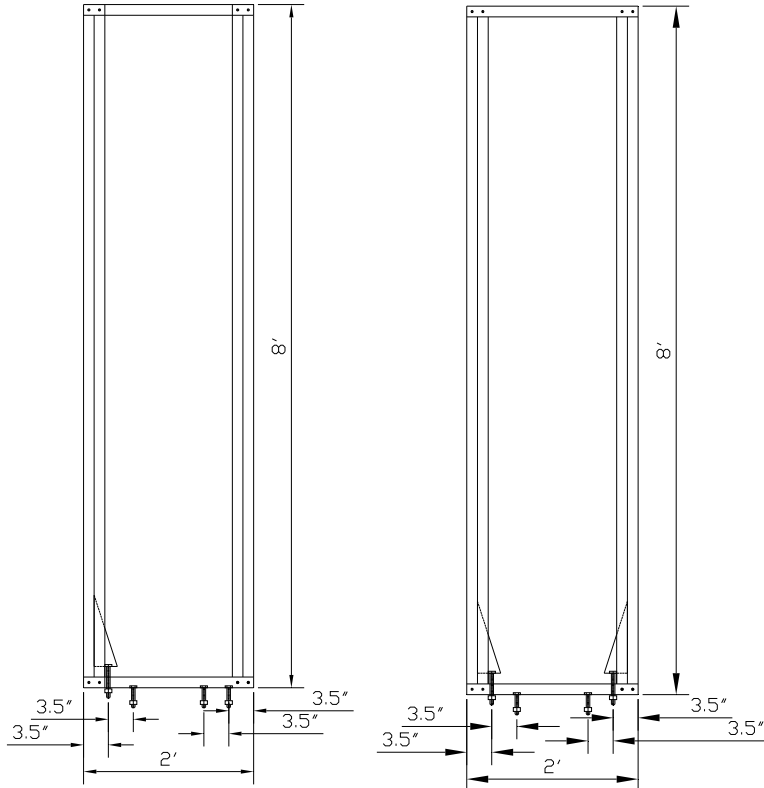

(a) wall assembly for monotonic test (b) wall assembly for cyclic test
Figure 7 Dimensions of 8-ft. x 2-ft. wall assembly

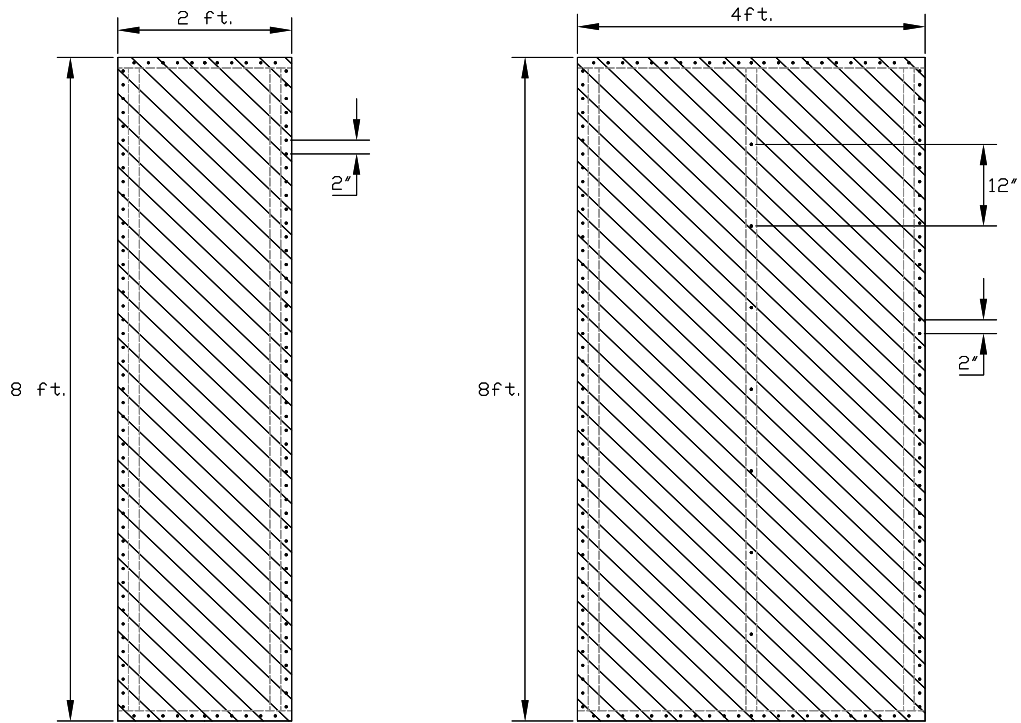

**8 ft. x 2 ft.
 Sheathed Shear Wall Assembly**

**8 ft. x 4 ft.
 Sheathed Shear Wall Assembly**

Figure 8 Typical screw panel edge and field location schedule (2"/12" spacing shown)

The sheet steel sheathing was installed on one side of the wall with No. 8×18-1/2” modified truss head self-drilling screws. The typical screw panel edge and field location schedule is shown in Figure 8. The screw spacing of 2-in., 4-in., and 6-in. on the panel edges and 12-in. in the field was investigated, and the screws were installed on the outer flange of the boundary studs for all the tests in the main group. One sheet steel sheet was installed to the wall studs (vertical). Test results by Serrette (1996) indicated that the shear strength of the walls with steel sheet sheathing installed with a horizontal joint blocked at mid-height was higher than the walls with no horizontal joints in the sheet steel sheathing. Therefore, the results from this test program can conservatively be used for assemblies that have sheet steel sheathing with horizontal, blocked joints or vertical blocked joints.

The details of the components of the tested steel sheet walls are given as follows:

Studs:

- 350S162-33 SSMA structural stud, 0.033-in. 3-1/2-in. × 1-5/8-in. made of ASTM A1003 Grade 33 steel, placed in 2-ft. o. c. for 0.027-in. steel sheet walls.
- 350S162-43 SSMA structural stud, 0.043-in. 3-1/2-in. × 1-5/8-in. made of ASTM A1003 Grade 33 steel, placed in 2-ft. o. c. for 0.030-in. and 0.033-in. steel sheet walls.

Tracks:

- 350T150-33 SSMA structural track, 0.033-in. 3-1/2-in. × 1-1/2-in. made of ASTM A1003 Grade 33 steel for 0.027-in. steel sheet walls.
- 350T150-43 SSMA structural track, 0.043-in. 3-1/2-in. × 1-1/2-in. made of ASTM A1003 Grade 33 steel for 0.030-in. and 0.033-in. steel sheet walls.

Sheathing:

- 0.033-in. thick ASTM A1003 Grade 33 steel.
- 0.030-in. thick ASTM A1003 Grade 33 steel.
- 0.027-in. thick ASTM A1003 Grade 33 steel.
- Steel sheet was installed on one side of the wall assembly.

Framing and Sheathing Screws:

- No. 8×18-1/2-in. modified truss head self-drilling tapping screws. Spacing at panel edge is 6-, 4-, or 2-in. o.c.. Spacing in the field of the sheathing is 12-in. for all specimen configurations.

Hold-Downs:

- Simpson Strong-Tie[®] S/HD10S hold-downs with 15 - No. 14×1-in. HWH self-drilling tapping screws, and with 1/2-in. diameter Grade 8 anchor bolts. Hold-downs were raised 1.5-in. above the edges of the track flange.

Shear Anchor Bolts:

- 1/2-in. diameter Grade 8 anchor bolts with standard cut washers and nuts. Two bolts were used for each wall assembly.

For each specimen configuration, two identical tests were conducted. For the monotonic testing, a third specimen would be tested if the shear strength or stiffness of the second

specimen tests is not within 15% of the result of the first specimen tested. For the cyclic testing, a third specimen would be tested if the difference between the ultimate test loads of the first two specimens is more than 10% apart. The test matrix of the main group is summarized in Table 3. Figures 9 and 10 illustrate the definitions of the notations in the test label for the specimens in the main group.

Table 3 Test matrix for shear wall tests in the main group

Wall dimensions (height × width × framing member thickness)	Steel sheet thickness (in.)	Fastener spacing, Perimeter/Field (in./in.)	Number of monotonic tests	Number of cyclic tests
8 ft. × 4 ft. × 43 mil	0.033	2/12	2	2
8 ft. × 4 ft. × 43 mil	0.033	4/12	2	2
8 ft. × 4 ft. × 43 mil	0.033	6/12	2	2
8 ft. × 4 ft. × 43 mil	0.030	2/12	2	2
8 ft. × 4 ft. × 43 mil	0.030	4/12	2	2
8 ft. × 4 ft. × 43 mil	0.030	6/12	2	2
8 ft. × 4 ft. × 33 mil	0.027	2/12	2	2
8 ft. × 4 ft. × 33 mil	0.027	4/12	2	2
8 ft. × 4 ft. × 33 mil	0.027	6/12	2	2
8 ft. × 2 ft. × 43 mil	0.033	2/12	2	2
8 ft. × 2 ft. × 43 mil	0.033	4/12	2	2
8 ft. × 2 ft. × 43 mil	0.033	6/12	2	2
8 ft. × 2 ft. × 43 mil	0.030	2/12	2	2
8 ft. × 2 ft. × 43 mil	0.030	4/12	2	2
8 ft. × 2 ft. × 43 mil	0.030	6/12	2	2

Note: No. 8×18-1/2" modified truss head self-drilling tapping screws were used.
Wall studs, tracks and steel sheet are of Grade 33.

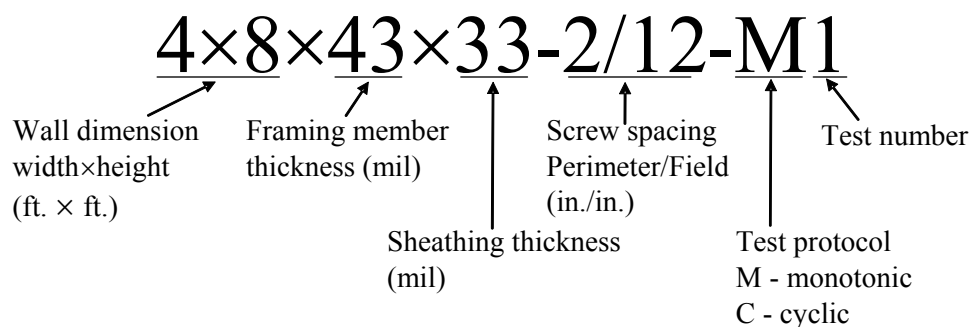

Figure 9 Definitions of the test label for 4 ft × 8 ft walls (main group)

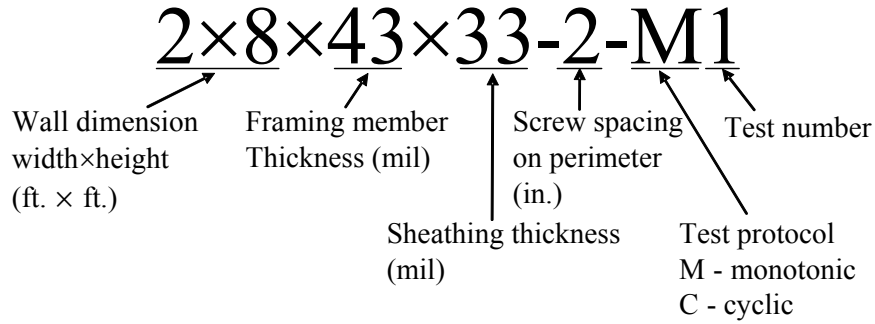

Figure 10 Definitions of the test label for 2-ft. × 8-ft. walls (main group)

The vertical gaps between the double boundary studs and the tracks were measured prior to the testing. Figure 11 illustrates the locations of the measured gaps and Tables 4 and 5 repressively summarize the pretest gaps for both the monotonic and the cyclic tests. The nominal length of the studs and the height of the sheathing are the same, 8-ft., therefore the nominal distance between the sheathing edge and the closest test frame edge is the thickness of the track member plus the gap between the stud and the track at the location in question. The actual distances between the sheathing edge and the test frame edge were not measured. However the test specimens were inspected prior to testing to ensure the sheathing did not extend beyond the framing.

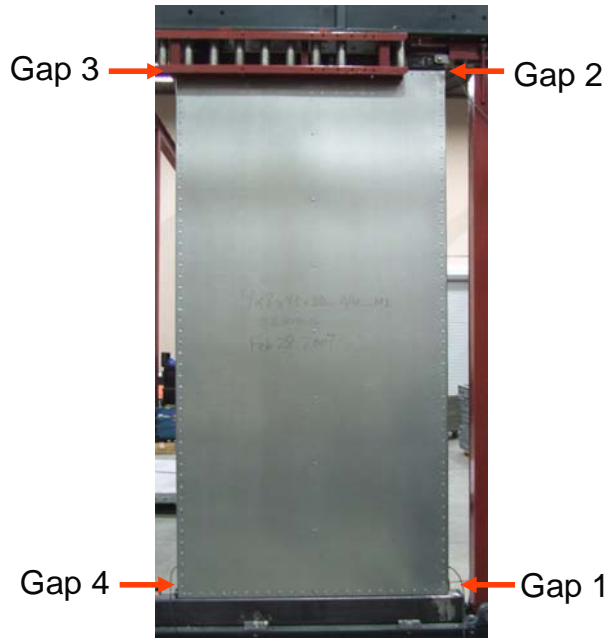

Figure 11 Locations of the measured gaps between top and bottom plate and studs

Table 4 Measured gaps between double studs and tracks for monotonic test walls (main group)

Test label	Gap 1 (in.)	Gap 2 (in.)	Gap 3 (in.)	Gap 4 (in.)
4×8×43×33-6/12-M1	1/16	1/16	1/16	1/16
4×8×43×33-6/12-M2	1/16	1/16	1/8	1/16
4×8×43×33-4/12-M1	1/8	1/8	1/8	1/16
4×8×43×33-4/12-M2	1/16	1/8	1/16	1/16
4×8×43×33-2/12-M1	1/8	1/16	1/16	1/8
4×8×43×33-2/12-M2	1/16	1/8	1/16	1/16
4×8×43×30-6/12-M1	-	-	-	-
4×8×43×30-6/12-M2	1/8	1/8	1/4	1/8
4×8×43×30-4/12-M1	1/16	1/8	1/8	1/16
4×8×43×30-4/12-M2	1/16	1/16	0	1/8
4×8×43×30-2/12-M1	1/16	1/8	1/8	1/8
4×8×43×30-2/12-M2	1/32	1/32	1/32	1/16
4×8×33×27-6/12-M1	1/8	1/8	1/16	1/16
4×8×33×27-6/12-M2	1/8	1/8	1/8	1/8
4×8×33×27-4/12-M1	1/16	1/8	1/16	1/16
4×8×33×27-4/12-M2	1/16	1/16	1/8	1/16
4×8×33×27-2/12-M1	1/8	1/8	1/4	1/8
4×8×33×27-2/12-M2	1/8	1/16	1/8	1/8
2×8×43×33-6-M1	1/16	1/16	1/8	1/16
2×8×43×33-6-M2	0	1/16	1/16	1/16
2×8×43×33-4-M1	0	1/8	1/8	1/16
2×8×43×33-4-M2	0	1/16	0	0
2×8×43×33-2-M1	1/32	1/16	1/16	1/8
2×8×43×33-2-M2	1/8	1/32	1/16	1/16
2×8×43×30-6-M1	1/16	1/8	1/16	1/32
2×8×43×30-6-M2	0	1/8	1/8	1/16
2×8×43×30-4-M1	1/16	1/16	1/16	1/32
2×8×43×30-4-M2	1/16	1/32	1/16	1/32
2×8×43×30-2-M1	1/16	1/8	1/16	1/8
2×8×43×30-2-M2	1/8	1/16	1/8	1/16

Table 5 Measured gaps between double studs and tracks for cyclic test walls (main group)

Test label	Gap 1 (in.)	Gap 2 (in.)	Gap 3 (in.)	Gap 4 (in.)
4×8×43×33-6/12-C1	1/8	1/16	1/16	1/8
4×8×43×33-6/12-C2	1/8	1/8	1/8	1/16
4×8×43×33-4/12-C1	1/16	1/16	1/8	1/16
4×8×43×33-4/12-C2	1/8	1/8	1/8	1/8
4×8×43×33-2/12-C1	0	1/16	1/16	0
4×8×43×33-2/12-C2	0	0	1/16	0
4×8×43×30-6/12-C1	1/32	1/8	1/8	1/8
4×8×43×30-6/12-C2	1/8	3/16	1/16	1/8
4×8×43×30-4/12-C1	1/16	1/16	1/16	1/16
4×8×43×30-4/12-C2	1/16	1/8	1/16	1/16
4×8×43×30-2/12-C1	1/16	1/16	1/16	1/8
4×8×43×30-2/12-C2	1/8	1/8	1/16	0
4×8×33×27-6/12-C1	1/16	1/8	1/8	1/16
4×8×33×27-6/12-C2	0	1/8	0	1/16
4×8×33×27-4/12-C1	1/8	1/8	1/8	1/8
4×8×33×27-4/12-C2	1/8	1/8	1/16	1/8
4×8×33×27-2/12-C1	1/8	1/8	1/8	1/8
4×8×33×27-2/12-C2	1/8	1/8	1/8	1/8
2×8×43×33-6-C1	0	1/8	1/8	1/16
2×8×43×33-6-C2	1/8	1/8	1/16	1/8
2×8×43×33-4-C1	1/8	1/8	1/8	0
2×8×43×33-4-C2	1/16	1/16	0	1/16
2×8×43×33-2-C1	1/8	1/16	1/16	1/16
2×8×43×33-2-C2	1/16	1/8	0	1/8
2×8×43×30-6-C1	1/8	0	0	1/16
2×8×43×30-6-C2	1/16	0	1/16	0
2×8×43×30-4-C1	1/16	1/16	1/16	1/16
2×8×43×30-4-C2	1/16	1/16	1/16	1/16
2×8×43×30-2-C1	0	1/16	1/8	1/16
2×8×43×30-2-C2	1/8	1/16	0	1/16

Test Specimens - Supporting Group

In addition to the main group specimens, a total of six tests were performed to investigate some configurations not included in the main group. The first five tests in the supporting group were performed at the beginning stage of the entire test program. The purpose of those additional tests was to investigate: (1) the difference between No. 8×1/2-in. and No. 10×3/4-in. self-drilling tapping screws when applied to sheet steel sheathed shear walls; and (2) the screw installation pattern on the boundary studs. Besides the fastener size and spacing, those five additional specimens used the same configurations as specified in the previous section for the main group.

The difference between No. 8×1/2-in. and No. 10 × 3/4-in. self-drilling tapping screw was studied by one cyclic test on 8-ft. × 4-ft. wall with 6-in./12-in. screw spacing schedule. Three screw patterns were investigated in the supporting group: screws on the outer boundary stud (shown in Figure 8, and eventually chosen for the main group tests), screws on the inner boundary stud (shown in Figure 12), and screws staggered on the boundary studs (shown in Figure 13). For the pattern with screws on inner boundary stud, the overall dimensions of the wall had to be 8-ft. (high) × 4-ft. 3-1/4-in. (wide) to fit the 8-ft. × 4-ft. sheet. This screw pattern was also adopted by Serrette (1997). Table 6 summarizes the configurations of the supporting group specimens. Table 7 provides the measured vertical gaps between the boundary studs and the tracks, and Figure 11 shows the locations of the gaps.

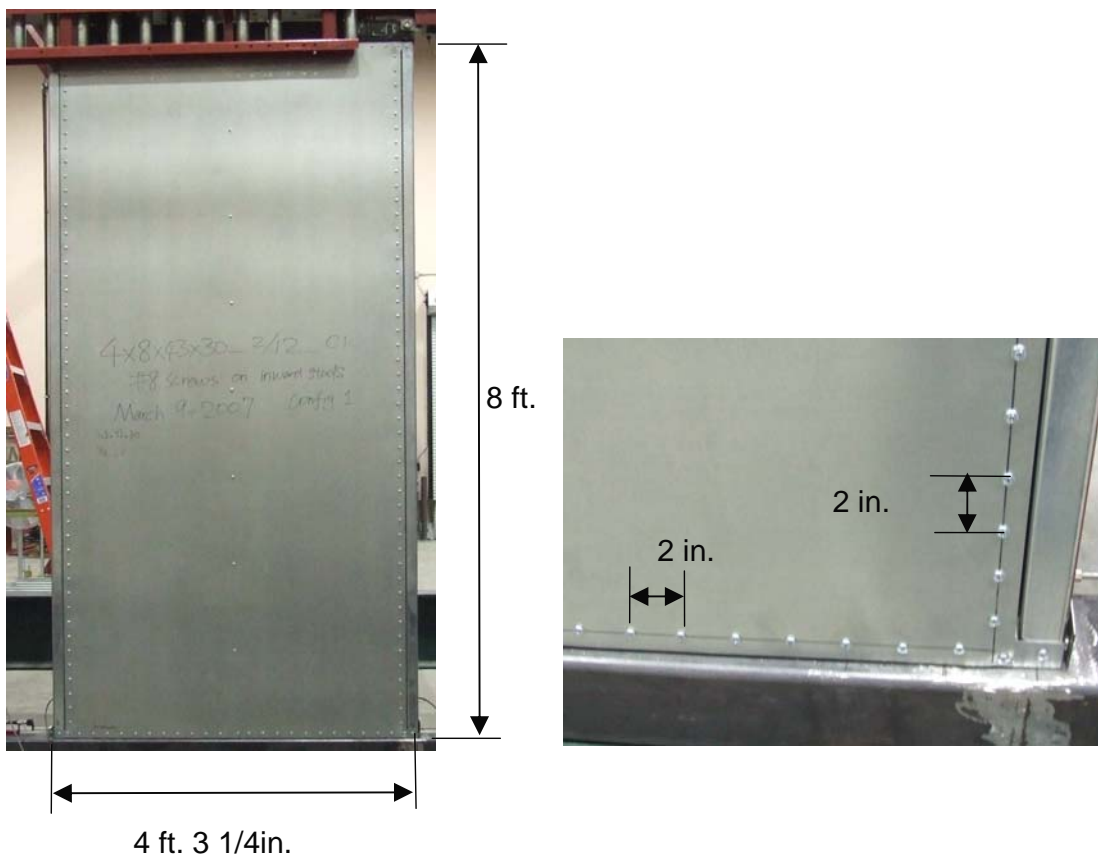

Figure 12 Screws installed on inner boundary stud (2''/12'')

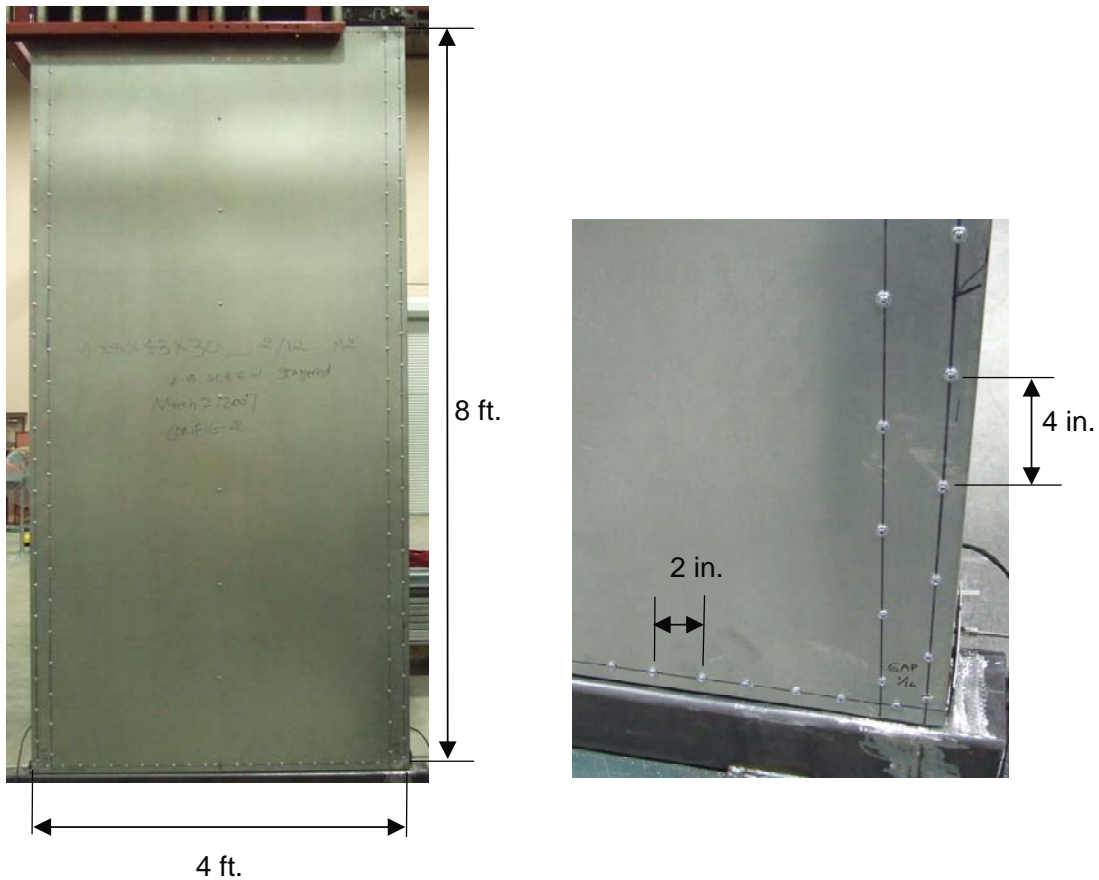

Figure 13 Staggered screw pattern (2''/12'')

Table 6 Configurations of the additional shear wall tests (supporting group)

Test label	Wall dimensions (height × width × framing member thickness)	Steel sheet thickness (in.)	Screw size and installation pattern on boundary studs	Screw spacing Perimeter/Field (in./in.)	Test protocol
A-1	8 ft. × 4 ft. × 43 mil	0.030	No. 10 on outer stud	6/12	Cyclic
A-2	8 ft. × 4 ft. × 43 mil	0.030	No. 8 on inner stud	2/12	Monotonic
A-3	8 ft. × 4 ft. × 43 mil	0.030	No. 8 on inner stud	2/12	Cyclic
A-4	8 ft. × 4 ft. × 43 mil	0.030	No. 8 staggered on studs	2/12	Monotonic
A-5	8 ft. × 4 ft. × 43 mil	0.030	No. 8 staggered on studs	2/12	Cyclic
A-6	8 ft. × 4 ft. × 43/33 mil	0.027	No. 8 on outer stud	4/12	Cyclic

The sixth test (listed as A-6 in Tables 6 and 7) in the supporting group was performed at the end of this project to investigate one specific configuration in which thicker framing members were used in the wall assembly with 0.027-in. sheet steel sheathing. Unlike all the other wall assemblies in this test program which used same thickness in the framing members, the sixth specimen in the supporting group used SSMA 350S162-43 Grade 33 studs, and SSMA 350T150-33 Grade 33 tracks. The purpose of this additional test was to study the option using different thicknesses in framing and to have a direct comparison with the tests performed by Ellis (2007).

Table 7 Measured gaps between double studs and tracks for additional specimens (supporting group)

Test label	Gap 1 (in.)	Gap 2 (in.)	Gap 3 (in.)	Gap 4 (in.)
A-1	1/32	1/8	1/8	1/8
A-2	1/8	1/8	1/8	1/8
A-3	1/16	1/16	1/16	1/8
A-4	1/16	1/16	1/8	1/16
A-5	1/8	1/8	1/8	1/8
A-6	1/16	1/16	1/16	1/16

TEST RESULTS

Shear Wall Tests for Specimens in Main Group

A total of 30 monotonic tests and 30 cyclic tests were conducted for the specimens in the main group. The main group specimens employed No. 8 × 18 × 1/2-in. modified truss head self-drilling tapping screws and the screws were installed on the outer flange of both boundary studs. For all specimen configurations, the difference between the two tests were within the required values (15% for monotonic tests, 10% for cyclic tests), therefore, the third test was not required for any cases.

The observed failure mode and measured responses of all monotonic tests are provided in Appendix A. The response curve for each test gives the relationships between the applied load in pounds per linear foot (plf) and the lateral displacement of the top of the wall.

Table 8 summarizes the monotonic test results for the main group specimens. The nominal shear strengths are calculated as the average of the peak loads of two tests.

In the 4-ft. × 8-ft. walls monotonic tests, the back-to-back double boundary studs were able to provide enough resistance against overturning forces. For the wall assemblies with 4"/12" and 6"/12" screw spacing, the failure resulted from a combination of buckling of the steel sheet and pullout of screws from the studs. Figure 14(a) shows a typical failure mode for a 0.033" sheet steel walls with 6"/12" screw spacing schedule. For the 4 ft. × 8 ft. walls with 2"/12" screw schedule, the failure was buckling of the outer flange of the boundary stud and no screw pullout failure was observed. Figure 14(b) shows the typical stud failure for 0.033" sheet wall with 2"/12" screw schedule.

In the 2-ft. × 8-ft. wall monotonic tests, it was found that the displacement at peak load was consistently greater than those in the 4-ft. × 8-ft. wall tests. Similar to the failure modes for the 4-ft. × 8-ft. walls, a combination of sheet buckling and screw pullout was observed for 2-ft. × 8-ft. walls with 6"/12" or 4"/12" screw spacing schedule. Also a combination of sheet buckling and flange distortion of the double boundary studs was observed for 2-ft. × 8-ft. walls with 2"/12" screw spacing schedule. In addition to those modes, the buckling in the web and flange of the double boundary studs at the compression side was also observed on walls with 2"/12" screw schedule. Figure 15 shows this boundary stud buckling failure.

The monotonic test results of this project may be conservatively compared to the actual field applications, as the hold-downs generally are installed on the boundary studs at each end of the shear wall and the hold-down on the compression side may help to reduce the actual boundary stud buckling length.



(a) test 4x8x43x33-6/12-M1



(b) test 4x8x33x33-2/12-M1

Figure 14 Typical failure modes for 4-ft. x 8-ft. walls in monotonic test



Figure 15 Buckling of double studs for 2-ft. x 8-ft. walls with 2 1/2" screw spacing

Table 8 Monotonic test results for shear walls (main group)

Test label	Peak load (plf)	Nominal shear strength (plf)	Displacement of wall top @ peak load (in.)	Avg. disp. of wall top @ peak load (in.)	Ave. disp. of wall bottom @ peak load (in.)
4×8×43×33-6/12-M1	1023	1074	2.08	1.90	0.03
4×8×43×33-6/12-M2	1124		1.72		
4×8×43×33-4/12-M1	1173	1189	1.73	2.03	0.10
4×8×43×33-4/12-M2	1204		2.32		
4×8×43×33-2/12-M1	1317	1347	2.53	2.09	0.09
4×8×43×33-2/12-M2	1376		1.65		
4×8×43×30-6/12-M1	801	794	2.51	2.47	0.04
4×8×43×30-6/12-M2	786		2.43		
4×8×43×30-4/12-M1	940	959	2.47	2.62	0.04
4×8×43×30-4/12-M2	977		2.76		
4×8×43×30-2/12-M1	1078	1054	3.46	3.20	0.05
4×8×43×30-2/12-M2	1030		2.94		
4×8×33×27-6/12-M1	644	626	1.87	1.91	0.01
4×8×33×27-6/12-M2	607		1.95		
4×8×33×27-4/12-M1	685	684	1.90	2.11	0.02
4×8×33×27-4/12-M2	682		2.31		
4×8×33×27-2/12-M1	856	836	2.02	1.99	0.03
4×8×33×27-2/12-M2	816		1.96		
2×8×43×33-6-M1	1065	1017	3.13	2.80	0.01
2×8×43×33-6-M2	968		2.47		
2×8×43×33-4-M1	1147	1156	2.63	2.77	0.03
2×8×43×33-4-M2	1164		2.91		
2×8×43×33-2-M1	1386	1361	3.35	3.20	0.03
2×8×43×33-2-M2	1335		3.05		
2×8×43×30-6-M1	872	882	3.30	3.35	0.03
2×8×43×30-6-M2	891		3.40		
2×8×43×30-4-M1	937	950	3.32	3.29	0.03
2×8×43×30-4-M2	963		3.25		
2×8×43×30-2-M1	1096	1097	3.30	3.37	0.04
2×8×43×30-2-M2	1098		3.43		
<p>Note: No. 8×18-1/2" modified truss head self-drilling tapping screws were used to attach the sheet steel sheathing to the wall framing. Wall studs, tracks, and sheet steel are of Grade 33.</p>					

Table 9 CUREE cyclic test results for shear walls (main group)

Test label	Peak +load P ₊ (plf)	Peak -load P ₋ (plf)	Average peak load (plf)	Disp. ¹ at P ₊ (in.)	Disp. ¹ at P ₋ (in.)	Average disp. ^{1,2} (in.)	Nominal strength (plf)	Disp. ^{1,3} (in.)	Disp. ^{3,4} (in.)
4×8×43×33-6/12-C1	1158	-1067	1113	1.66	1.63	1.65	1093	1.63	0.12
4×8×43×33-6/12-C2	1160	-984	1072	1.63	1.59	1.61			
4×8×43×33-4/12-C1	1225	-1148	1187	1.69	1.89	1.79	1210	1.73	0.09
4×8×43×33-4/12-C2	1193	-1271	1232	1.70	1.66	1.67			
4×8×43×33-2/12-C1	1397	-1401	1399	1.57	1.91	1.74	1350	1.77	0.16
4×8×43×33-2/12-C2	1283	-1318	1301	1.52	2.08	1.80			
4×8×43×30-6/12-C1	864	-938	901	1.82	2.01	1.92	911	2.09	0.02
4×8×43×30-6/12-C2	932	-910	921	2.52	1.98	2.25			
4×8×43×30-4/12-C1	1008	-1073	1041	2.01	1.94	1.98	1014	2.01	0.03
4×8×43×30-4/12-C2	925	-1050	987	2.05	2.01	2.03			
4×8×43×30-2/12-C1	1067	-1079	1073	1.99	1.07	1.73	1070	1.75	0.06
4×8×43×30-2/12-C2	1048	-1084	1066	1.70	1.84	1.77			
4×8×33×27-6/12-C1	679	-628	653	1.51	1.58	1.54	647	1.53	0.07
4×8×33×27-6/12-C2	622	-658	640	1.62	1.42	1.52			
4×8×33×27-4/12-C1	708	-743	726	1.23	1.20	1.21	710	1.22	0.01
4×8×33×27-4/12-C2	694	-694	694	1.21	1.22	1.22			
4×8×33×27-2/12-C1	832	-773	802	1.73	1.66	1.70	845	1.79	0.08
4×8×33×27-2/12-C2	913	-861	887	2.06	1.67	1.87			
2×8×43×33-6-C1	1104	-1160	1132	2.86	3.10	2.98	1135	3.05	0.01
2×8×43×33-6-C2	1189	-1086	1137	2.96	3.26	3.11			
2×8×43×33-4-C1	1257	-1247	1252	3.19	2.84	3.02	1264	3.14	0.02
2×8×43×33-4-C2	1195	-1357	1276	3.34	3.17	3.25			
2×8×43×33-2-C1	1408	-1450	1429	3.09	3.10	3.09	1361	3.04	0.05
2×8×43×33-2-C2	1355	-1230	1292	3.19	2.80	2.99			
2×8×43×30-6-C1	942	-889	916	3.16	2.85	3.00	924	3.13	0.03
2×8×43×30-6-C2	970	-891	931	3.34	3.17	3.26			
2×8×43×30-4-C1	1046	-1065	1055	3.31	3.12	3.22	1053	3.16	0.02
2×8×43×30-4-C2	1119	-983	1051	3.18	2.99	3.09			
2×8×43×30-2-C1	1195	-1200	1198	3.33	-2.84	3.09	1203	3.03	0.02
2×8×43×30-2-C2	1171	-1246	1208	3.07	-2.85	2.96			

Note: 1– displacement of wall top; 2 – average displacement for each identical specimen; 3 - average displacement for each configuration; 4 – displacement of wall bottom.
 No. 8×18×1/2” modified truss head self-drilling tapping screws were used to attach the sheet steel sheathing to the wall framing.
 Wall studs, tracks, and sheet steel are of Grade 33.

The observed failure mode and measured responses of all cyclic tests in the main group are provided in Appendix B. Table 9 summarizes the cyclic test results for the main group specimens. The nominal shear strengths are calculated as the average of the peak loads of two tests.

In the 4-ft. × 8-ft. walls cyclic tests, one or more of the sheet steel sheathing fasteners pulled out from a portion of the interior stud for all specimens. Additionally, a combination of steel sheet sheathing buckling and screw pullout was observed for walls with 6"/12" and 4"/12" screw spacing schedule, and a combination of steel sheet sheathing buckling and flange distortion of the double boundary studs was observed for walls with 2"/12" screw spacing schedule. Figures 16 and 17 respectively show the hysteresis curve and the typical failure mode for 4-ft. × 8-ft. walls with panel edge screws spaced closer together. Figures 18 and 19 show typical hysteresis curves and typical failure mode for 2"/12" panel edge screw spacing.

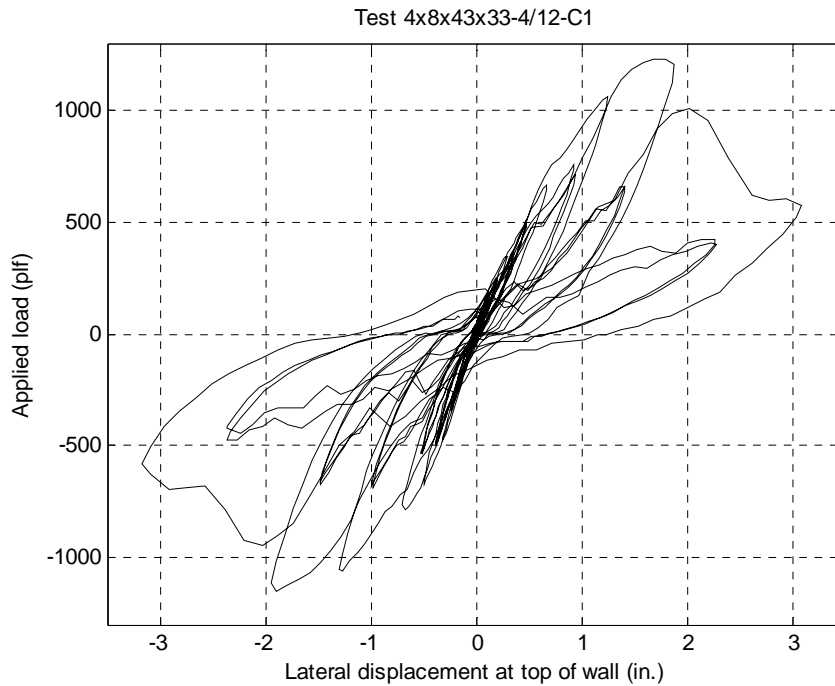

Figure 16 Observed hysteresis curve for test 4×8×43×33-4/12-C1

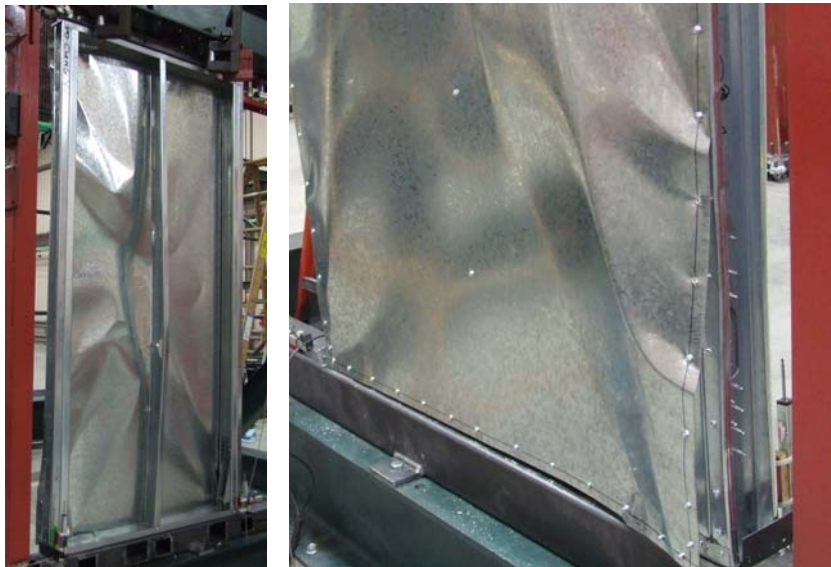

Figure 17 Failure mode for test 4×8×43×33-4/12-C1

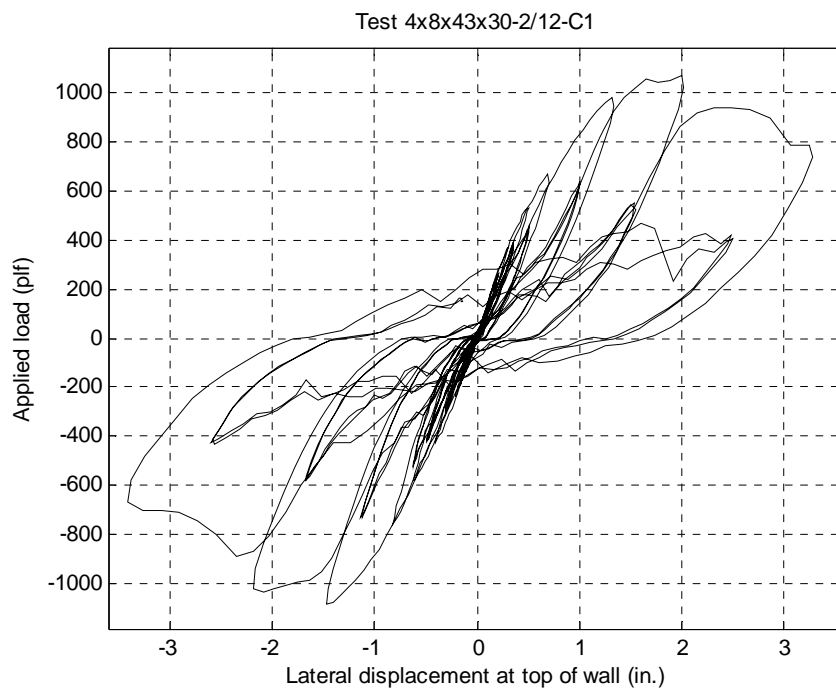

Figure 18 Observed hysteresis curve for test 4×8×43×30-2/12-C1



Figure 19 Failure mode for test 4×8×43×30-2/12-C1

In the 2-ft. × 8-ft. walls cyclic tests, the observed hysteresis curves show little post-peak behavior of the specimens. The 2-ft. × 8-ft. walls yielded large displacement capacity in the monotonic tests and these values were greater than the cap on the CUREE cyclic test reference displacement specified by ICC-ES AC130 (2.5% of wall height); therefore, the applied displacement to the top of wall was limited for the cyclic tests and was not sufficient to achieve post-peak behavior in some cases. Figures 20 and 21 show the typical hysteresis curves and failure mode for 2-ft. × 8-ft. wall assemblies.

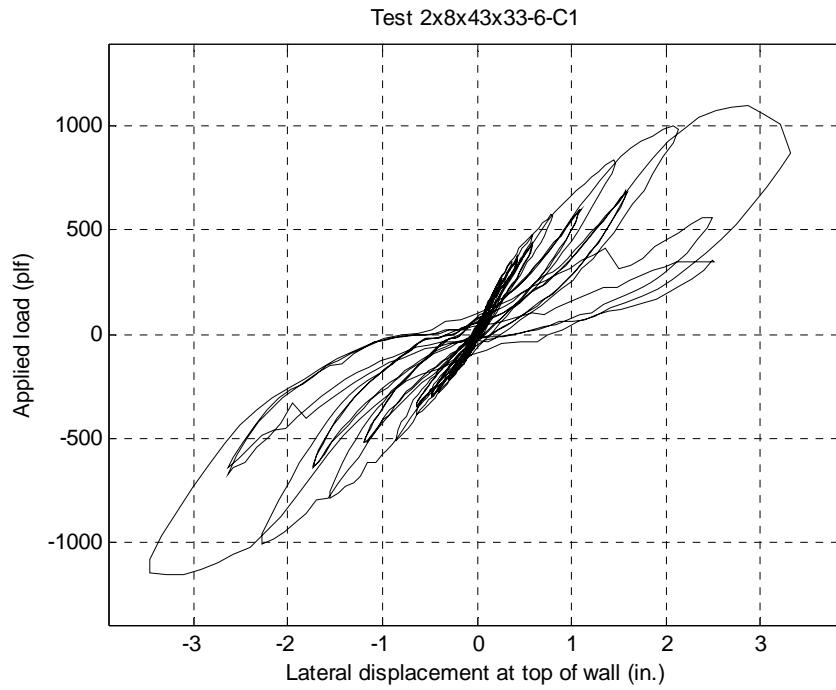

Figure 20 Observed hysteresis curve for cyclic test 2x8x43x33-6-C1



Figure 21 Failure mode for test 2x8x43x33-6-C1

Shear Wall Tests for Specimens in Supporting Group

The results for the additional shear wall tests are summarized in Table 10. The observed failure mode and measured responses are provided in Appendix C.

Table 10 Results of the additional shear wall tests (supporting group)

Test label	Test protocol	Peak load (plf)	Average peak load (plf)	Displacement of wall top @ peak load (in.)	Avg. disp. of wall top @ peak load (in.)	Comments
A-1	Cyclic	898 -868	883	2.03 -1.99	1.52	No. 10 screws on outer boundary stud
A-2	Monotonic	1091	1091	2.41	2.41	No. 8 screws on inner boundary stud
A-3	Cyclic	1179 -1137	1158	1.60 -1.33	1.47	No. 8 screws on inner boundary stud
A-4	Monotonic	1151	1151	2.60	2.60	No. 8 screws staggered on boundary studs
A-5	Cyclic	1164 -1133	1149	1.94 -2.04	1.98	No. 8 screws staggered on boundary studs
A-6	Cyclic	954 -860	907	1.40 -1.37	1.38	No. 8 screws on outer boundary stud

In was found in the previously conducted test 4×8×43×33-6/12-C1 that several of the No. 8 modified truss self-drilling tapping screws pulled out of the framing members, and this failure mode was more evident for shear walls with the panel edge screws spaced further apart. To compare the performance with the No. 10 screw, one cyclic test was conducted on specimen A-1 which employed the same configurations as test 4×8×43×33-6/12-C1 except that No. 10×3/4-in. flat truss self-drilling tapping screws were used. Test A-1 also failed by pullout of the screws at the bottom corners of the wall in addition to some at the interior stud. This is similar to the failure mode of test 4×8×43×33-6/12-C1. Figure 22 shows the failure mode of those two cyclic tests. The average peak load of A-1 was 883 plf, which is less than the result for 4×8×43×33-6/12-C1 using No. 8 screws, 901 plf. The No. 10×3/4-in. flat truss self-drilling tapping screws did not produce improved performance compared to No. 8-18×1/2-in. modified truss head self-drilling tapping screws in the cyclic shear wall test; therefore, the No. 8 sheathing screw was of the choice for this test program.



(a) test A-1 with No. 10 screws



(b) test 4×8×43×33-6/12-C1 with No. 8 screws

Figure 22 Comparison of the performance of No. 10 and No. 8 screws

At the early stage of this project, in addition to the steel sheet sheathing buckling, boundary stud failure was observed in the monotonic tests for 0.030-in. sheet 4-ft. × 8-ft. × 43-mil shear walls with 2”/12” screw spacing schedule. Figure 23 shows the observed stud failures. The outer flange of the boundary double studs distorted due to the buckling of the steel sheet. Because of the closer screw spacing, the load to the framing members was increased. In addition, the sheathing screws were able to hold the steel sheet sheathing to the framing during the test, therefore, transferring a significant amount of load to the outer flange to cause such flange distortion.



(a) test 4×8×43×33-2/12-M1



(b) test 4×8×43×33-2/12-M2

Figure 23 Stud failure of 4-ft. × 8-ft. walls in monotonic tests

Two alternative screw patterns (screws on inner boundary stud; screws staggered on boundary studs) were investigated in both the monotonic and cyclic shear wall tests. The test results show that both alternative screw patterns yielded higher (approximately 7%), but not much higher, shear strength than the original screw pattern (screws on the outer boundary stud). Also the stud failure was no longer evident for the two alternative configurations, only one test (A-5 with staggered pattern) demonstrated significant distortion on the outer boundary stud as shown in Figure 24.



Figure 24 Observed stud failure in test A-5

To further investigate the three sheathing screw to boundary members installation configurations, axial compression tests were also carried out on the boundary studs to examine their remaining vertical load capacity, after the cyclic tests. Figure 25 shows the compression test setup where the axial force was applied to the more damaged boundary double studs after the cyclic shear wall test. A 17-kip hydraulic cylinder and a 10-kip load cell were utilized for the compression tests. Table 11 summarizes the test results. It indicates that after the cyclic shear wall test, the shear wall with staggered screw pattern was the least damaged and still resisted over 10000-lbs vertical load at a vertical displacement of 0.16-in. The shear wall with screws on the outer boundary stud gave the weakest performance in the compression tests, but it still took a peak load of 5987-lbs which is still higher than the nominal compression strength of 4360-lbs according to the AISI Design Manual 2002 Edition for 2-350S162-33 studs with a 2'-0" unbraced length.

Based on the additional shear wall tests and the axial compression tests, it was decided to choose the “screws on the outer boundary stud” pattern for all the shear walls in this test program. Therefore, the nominal shear strength obtained from this research project represents the lower bound values among the three investigated screw installation configurations.



Figure 25 Set up for axial compression test

Table 11 Results of the axial compression tests

Specimen	Peak axial load (lbs)	Vertical displacement of stud @ peak load (in)	Comments
4×8×43-2/12-C1	5987	0.16	No. 8 screws on outer boundary stud
A-3	7925	0.10	No. 8 screws on inner boundary stud
A-5	>10000*	0.16	No. 8 screws staggered on boundary studs

Note: * test stopped at the capacity limit of the load cell.

Material Properties

Coupon tests were conducted according to the ASTM A370-06 “Standard Test Methods and Definitions for Mechanical Testing of Steel Products”. The test results are summarized in Table 12. The coating on the steel was removed by hydrochloric acid prior to the coupon tests. The coupons tests were conducted on the INSTRON[®] 4480 universal testing machine. An INSTRON[®] 2630-106 extensometer was employed to measure the tensile strain. The tests were conducted in displacement control at a constant rate of 0.05 in./min.

Table 12 Coupon Test Results

Member	Uncoated Thickness (in.)	Yield Stress (ksi) (% higher than specified value)	Tensile Strength (ksi) (% higher than specified value)	Tensile Strength/ Yield Stress Ratio	Elongation for 2 in. Gage Length (%)
33 mil steel sheet	0.0358	43.4 (32%)	53.8 (20%)	1.24	27%
30 mil steel sheet	0.0286	48.9 (48%)	55.6 (24%)	1.08	24%
27 mil steel sheet	0.0240	50.3 (52%)	57.8 (28%)	1.15	21%
43 mil stud	0.0430	47.6 (44%)	55.1 (22%)	1.15	29%
33 mil stud	0.0330	47.7 (45%)	55.7 (24%)	1.17	24%
43 mil track	0.0420	43.1 (31%)	55.6 (24%)	1.29	25%
33 mil track	0.0330	57.4 (74%)	67.2 (49%)	1.17	28%
Note: Steel is specified as Grade 33 for all members. The specified minimum yield stress is 33 ksi and specified minimum tensile strength is 45 ksi.					

The test results indicate that the measured uncoated thickness is less than the required minimum base metal (i.e., uncoated) thickness per the AISI General Provisions (2004) Table A5.1-1 for the 30 and 27 mil steel sheet. All the coupons meet the minimum ductility requirement by North American Specification for Design of Cold-Formed Steel Structural Members 2001 Edition (AISI 2001), which requires the tensile strength to yield strength ratio greater than 1.08, and the elongation on a 2-in. gage length higher than 10%. The material used in this project was in accordance with ASTM A1003 Grade 33 Type H classification as per AISI Lateral Standard (2004) Section C5.4.

DISCUSSION AND DESIGN EXAMPLES

Nominal Shear Strength

The nominal shear strength is determined as the average peak load of all the identical tests. The nominal shear strength for wind loads is based on monotonic test results and the nominal shear strength for seismic loads is obtained from the cyclic tests. The nominal strength of the cyclic tests is taken as the average of the peak load from the positive and negative quadrants of the hysteresis curve plot. Figures 26 and 27 present the plots of the nominal strength vs. the fastener spacing at panel edges for wind loads and seismic loads.

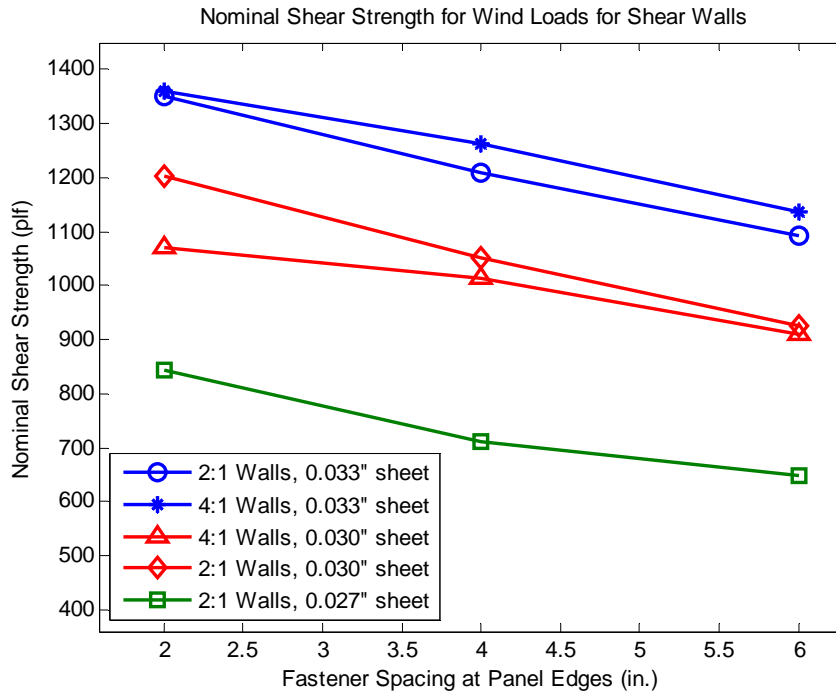

Figure 26 Nominal strengths for wind loads vs. fastener spacing at panel edges

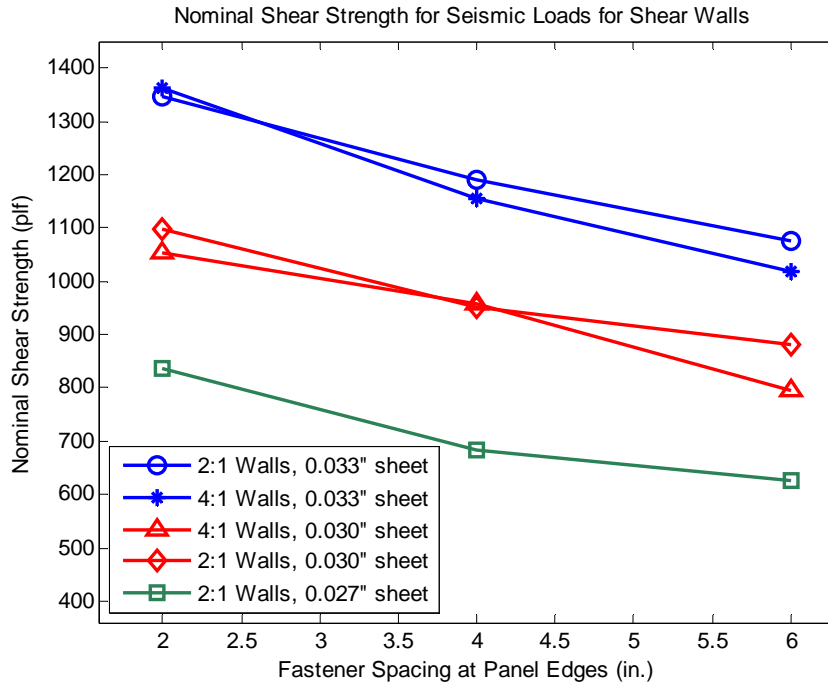

Figure 27 Nominal strengths for seismic loads vs. fastener spacing at panel edges

Figures 26 and 27 indicate that the relationship between the nominal shear strength and the fastener spacing at panel edges could be assumed as linear. In this test program, fastener spacing of 6-in., 4-in., and 2-in. were investigated, therefore the nominal strength for walls with 3 in. fastener spacing can be estimated as the average of nominal strengths for 4 in. and 2 in. fastener spacing.

Per the North American Specification for the Design of Cold-Formed Steel Structural Members Chapter F, the nominal loads tabulated in Tables 13 and 14 need to be adjusted by the $F_{y-spec'd}/F_{y-tested}$ or $F_{u-spec'd}/F_{u-tested}$ and $t_{spec'd}/t_{tested}$. The coupon tests indicate that the measured base metal (i.e., uncoated) thickness for 0.030-in. sheet steel, 0.0286-in., was less than the design thickness, 0.0312-in., and the measured base metal thickness for 0.027-in. sheet steel, 0.0240-in., is less than the design thickness, 0.0283-in., therefore no adjustment due to variation in the thickness is needed for 0.030-in. and 0.027-in. steel sheet walls. However for the 0.033-in. sheet steel, the measured base metal thickness (0.0358-in.) is greater than the design thickness (0.0346-in.), therefore the nominal strength need to be adjusted by the ratio of $0.0346/0.0358 = 0.966$.

The differences between the measured and the specified tensile strength and the yield strength were also observed in the coupon tests. Therefore, footnotes to the tables will state the minimum material strengths required to use the tabulated values. Future testing of shear wall assemblies with members that have close to specified strength may be completed in the future to determine what effect members with greater than the minimum specified strength have on a shear wall assembly. Most likely the shear wall component to affect the strength of the assembly the most will be the sheet steel sheathing.

Based on the results of this research project, thickness-adjusted nominal shear strengths for sheet steel shear walls are summarized in Tables 13 and 14.

**Table 13 Recommended nominal shear strength for wind loads for shear walls^{1,2,3}
(Pounds Per Foot)**

Assembly Description	Aspect Ratio (h:w)	Fastener Spacing at Panel Edges (inches)			
		6	4	3	2
0.033" steel sheet, one side ⁴	2:1	1037	1146	1225	1301
0.030" steel sheet, one side ⁴	2:1	794	959	1007	1054
0.027" steel sheet, one side ⁵	2:1	626	684	760	836
Note: (1) Screws in the field of panel shall be installed 12 inch on center. (2) Sheet steel sheathing, wall studs, tracks, and blocking shall be of ASTM A1003 Grade 33 Type H steel with minimum yield strength, F_y , of 43 ksi and a minimum tensile strength, F_u , of 54 ksi. (3) Shear wall height to width aspect ratios (h/w) greater than 2:1, but not exceeding 4:1, shall be permitted provided the tabulated nominal strength values are multiplied by 2w/h. (4) Wall studs, tracks, and blocking shall be of 43 mils or thicker. (5) Wall studs, tracks, and blocking shall be of 33 mils or thicker.					

**Table 14 Recommended nominal shear strength for seismic loads for shear walls^{1,2,3}
(Pounds Per Foot)**

Assembly Description	Aspect Ratio (h:w)	Fastener Spacing at Panel Edges (inches)			
		6	4	3	2
0.033" steel sheet, one side ⁴	2:1	1056	1169	1236	1304
0.030" steel sheet, one side ⁴	2:1	911	1014	1042	1070
0.027" steel sheet, one side ⁵	2:1	647	710	778	845
Note: (1) Screws in the field of panel shall be installed 12 in. o.c. (2) Sheet steel sheathing, wall studs, tracks, and blocking shall be of ASTM A1003 Grade 33 Type H steel with minimum yield strength, F_y , of 43 ksi and a minimum tensile strength, F_u , of 54 ksi. (3) Shear wall height to width aspect ratios (h/w) greater than 2:1, but not exceeding 4:1, shall be permitted provided the tabulated nominal strength values are multiplied by 2w/h. (4) Wall studs, tracks, and blocking shall be of 43 mils or thicker, but the framing thickness shall be limited and/or the screw diameter increased to ensure that the screw itself not fail in shear. (5) Wall studs, tracks, and blocking shall be of 33 mils or thicker, but the framing thickness shall be limited and/or the screw diameter increased to ensure that the screw itself not fail in shear.					

Reduction Factor

The AISI Lateral Standard (2004) permits some shear wall assemblies resisting wind or seismic loads to exceed the 2:1 aspect ratio limit, but requires that the nominal shear strength be reduced by a factor of $2w/h$ for those assemblies with a height to width aspect ratio (h/w) greater than 2:1. It also requires that the allowable strength (ASD) be determined by dividing the nominal shear strength by a safety factor of 2.5 for assemblies resisting seismic loads and 2.0 for assemblies resisting wind loads. The 2006 International Building Code limits story drift for seismic force-resisting systems for structures 4 stories or less with interior walls, partitions, ceilings and exterior wall systems that have been designed to accommodate the story drifts to $0.025h$. This story drift limit is 0.60" for LRFD ($0.025h/Cd$) and 0.43" (LRFD story drift / 1.4) for ASD for an 8-ft. wall height. There is no in-plane story drift limit for wind loads yet defined by the codes, but ASCE 7-05 Commentary Section CC.1.2 states "Drifts of concern in serviceability checking arise primarily from the effects of wind. Drift limits in common usage for building design are on the order or $1/600$ to $1/400$ of the story height. An absolute limit on interstory drift may also need to be imposed in light of evidence that damage to non-structural partitions, cladding and glazing may occur if the interstory drift exceeds about $3/8$ " unless special detailing practices are made to tolerate movement."

Table 15 summarizes the allowable shear strength (ASD) based on a $h/180$ drift limit for wind loads and Table 16 summarizes the allowable shear strength (ASD) based on ultimate load limit for wind loads which are determined by dividing the nominal shear strength by a safety factor of 2.0. If one considers the $h/180$ drift limit for wind, the allowable shear strength shall be the lesser of the values in Table 15 and Table 16.

Table 15 Allowable shear strength (ASD) based on $h/180$ drift limit for wind loads (plf)

Assembly Description	Aspect Ratio (h:w)	Fastener Spacing at Panel Edges (inches)		
		6	4	2
0.033" steel sheet, one side	2:1	535	622	590
0.030" steel sheet, one side	2:1	327	358	403
0.027" steel sheet, one side	2:1	360	395	456
0.033" steel sheet, one side	4:1	404	448	394
0.030" steel sheet, one side	4:1	307	351	295

Figures 28 to 32 show the comparison of load-displacement curves for the monotonic tests. In each figure, the tested specimens with same framing and sheathing members but different fastener spacing at the edge (6", 4", or 2") are compared. For clarity, the unloading and portion of the reloading curves at the two load increments were not shown in the figures. This comparison indicates that the fastener spacing at the edge does not greatly affect the elastic stiffness of the wall assembly, therefore, the shear strength values at the $h/180$ drift limit (0.53-in. for 8-ft high walls) for wind loads for the different fastener spacing configurations are similar with a maximum load difference of up to 22% (reference Table 15 values). Similar results were also observed in the cyclic tests.

Table 16 Allowable shear strength (ASD) based on ultimate load limit for wind loads

Assembly Description	Aspect Ratio (h:w)	Fastener Spacing at Panel Edges (inches)		
		6	4	2
0.033" steel sheet, one side	2:1	519	577	651
0.030" steel sheet, one side	2:1	397	480	527
0.027" steel sheet, one side	2:1	313	342	418
0.033" steel sheet, one side	4:1	492	558	658
0.030" steel sheet, one side	4:1	441	475	549

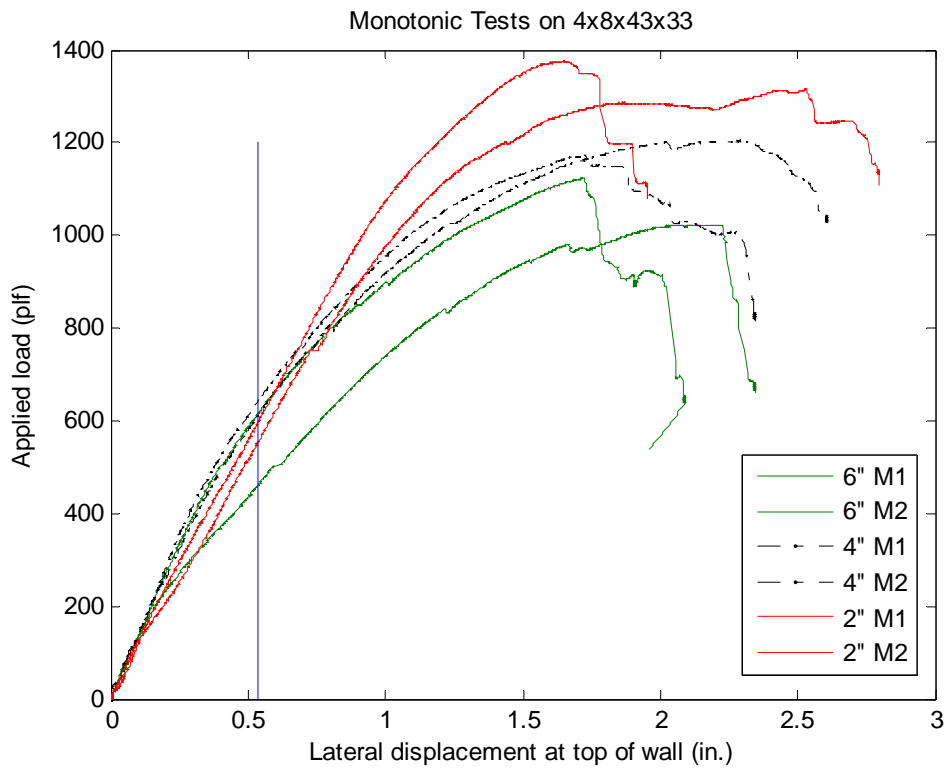

Figure 28 Comparison of hysteresis curves for 4-ft. × 8-ft. 0.033" sheet steel walls

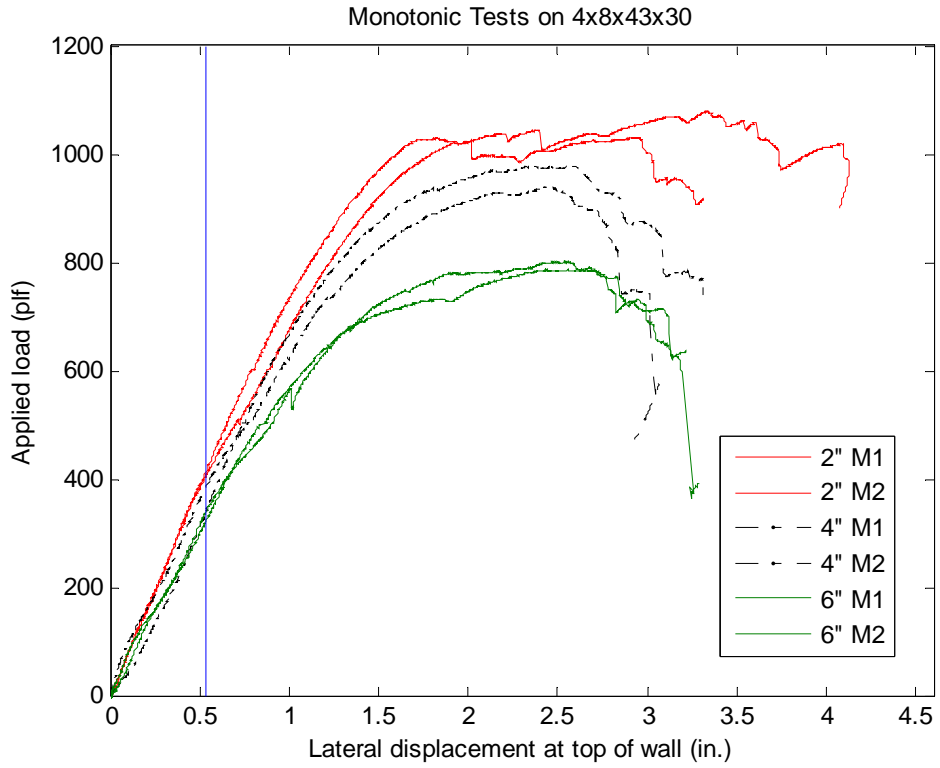

Figure 29 Comparison of hysteresis curves for 4-ft. × 8-ft. 0.030" sheet steel walls

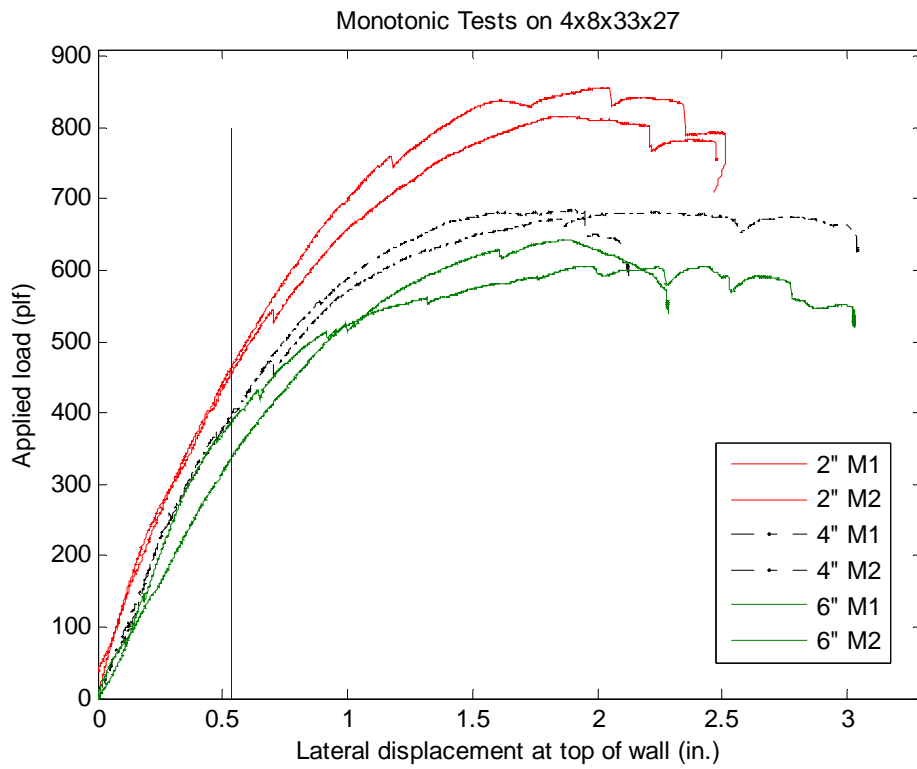

Figure 30 Comparison of hysteresis curves for 4-ft. × 8-ft. 0.027" sheet steel walls

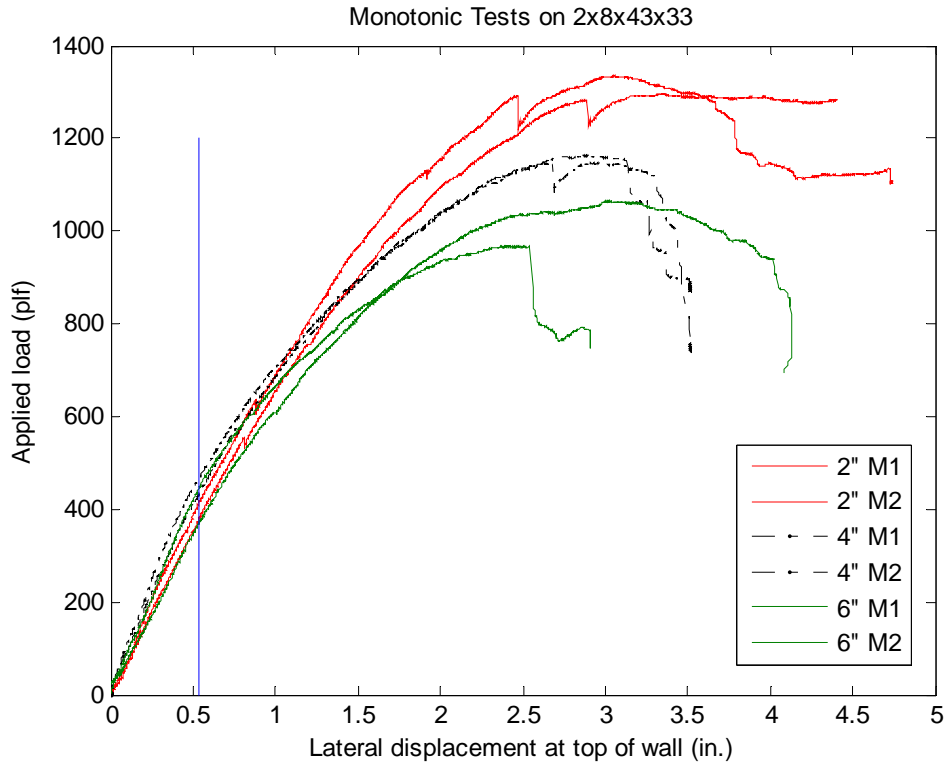

Figure 31 Comparison of hysteresis curves for 2-ft. × 8-ft. 0.033" sheet steel walls

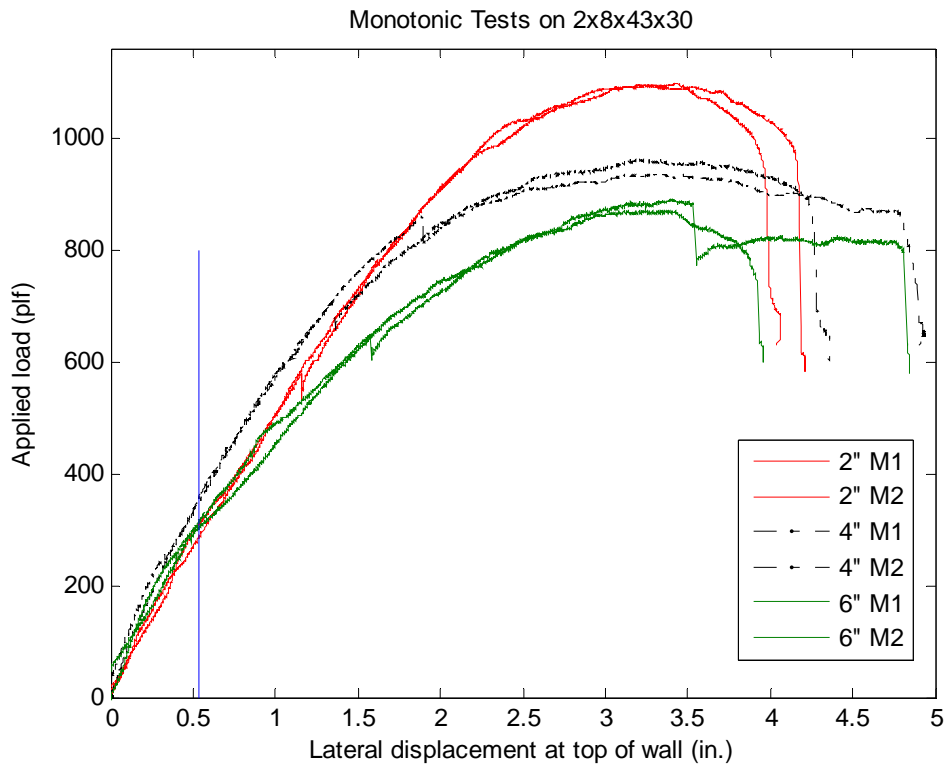

Figure 32 Comparison of hysteresis curves for 2-ft. × 8-ft. 0.030" sheet steel walls

Table 17 summarizes the actual drift reduction factors determined by dividing the h/180 drift limited shear wall wind load value (Table 15) by the ultimate wind load value (Table 16). The code reduction factor by AISI Lateral Standard (2004) is 1.0 for assemblies with aspect ratio of 2:1 and 2w/h for assemblies with aspect ratio greater than 2:1, but not exceeding 4:1, where permitted. Figure 33 illustrates the comparison of the code reduction factor and the actual reduction factors from the monotonic tests.

Table 17 Actual reduction factors for monotonic tests

Assembly Description	Aspect Ratio (h:w)	Fastener Spacing at Panel Edges (inches)		
		6	4	2
0.033" steel sheet, one side	2:1	0.996	1.000	0.849
0.030" steel sheet, one side	2:1	0.824	0.747	0.765
0.027" steel sheet, one side	2:1	1.000	1.00	1.000
0.033" steel sheet, one side	4:1	0.732	0.777	0.578
0.030" steel sheet, one side	4:1	0.719	0.707	0.552

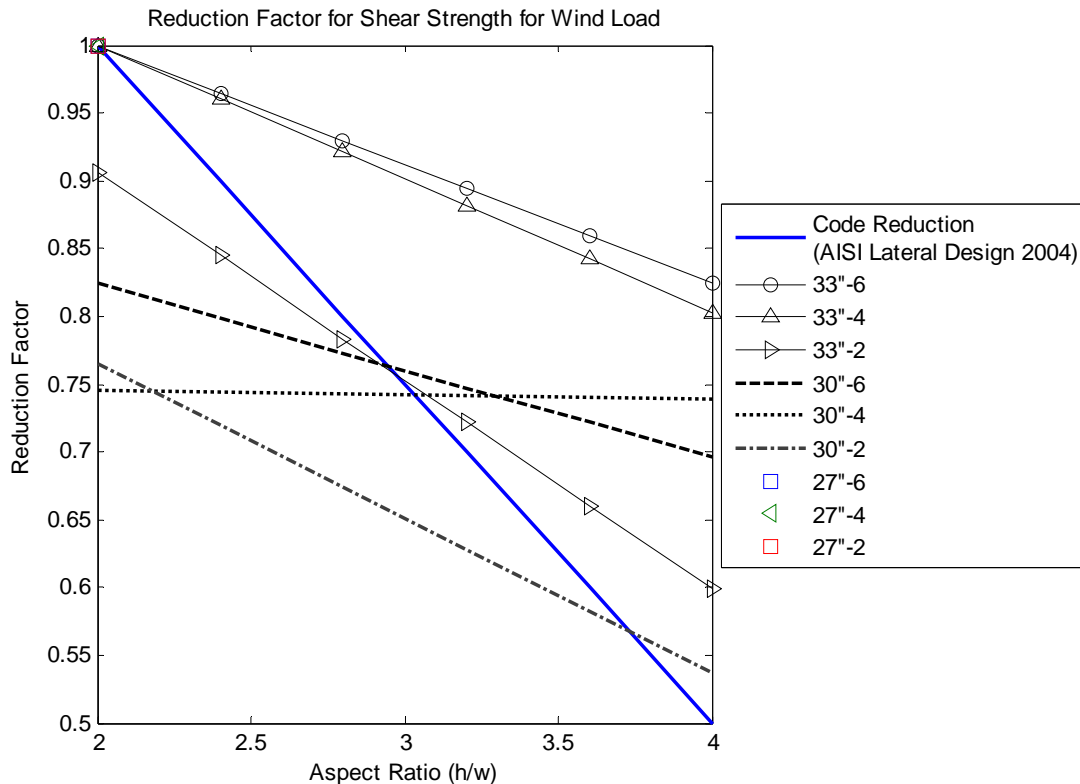

Figure 33 Reduction factors for shear strength for wind loads

Table 18 summarizes the allowable shear strength (ASD) based on the drift limit, 0.43-in., for seismic loads. The allowable shear strength (ASD) based on ultimate load limit is

summarized in Table 19. These values are determined by dividing the nominal shear strength (partially listed in Table 14) by a safety factor of 2.5. The actual reduction factors for seismic loads are listed in Table 20. Figure 34 shows the comparison of the code reduction factors and the actual values from the cyclic tests.

Table 18 Allowable shear strength (ASD) based on drift limit for seismic loads

Assembly Description	Aspect Ratio (h:w)	Fastener Spacing at Panel Edges (inches)		
		6	4	2
0.033" steel sheet, one side	2:1	358	404	438
0.030" steel sheet, one side	2:1	329	365	355
0.027" steel sheet, one side	2:1	279	240	294
0.033" steel sheet, one side	4:1	351	338	313
0.030" steel sheet, one side	4:1	261	262	295

Table 19 Allowable shear strength (ASD) based on ultimate load limit for seismic loads

Assembly Description	Aspect Ratio (h:w)	Fastener Spacing at Panel Edges (inches)		
		6	4	2
0.033" steel sheet, one side	2:1	422	468	522
0.030" steel sheet, one side	2:1	364	406	428
0.027" steel sheet, one side	2:1	259	284	338
0.033" steel sheet, one side	4:1	439	489	526
0.030" steel sheet, one side	4:1	370	421	481

Table 20 Actual reduction factors for cyclic tests

Assembly Description	Aspect Ratio (h:w)	Fastener Spacing at Panel Edges (inches)		
		6	4	2
0.033" steel sheet, one side	2:1	0.849	0.864	0.839
0.030" steel sheet, one side	2:1	0.904	0.899	0.829
0.027" steel sheet, one side	2:1	1.000	0.845	0.870
0.033" steel sheet, one side	4:1	0.800	0.692	0.596
0.030" steel sheet, one side	4:1	0.705	0.622	0.613

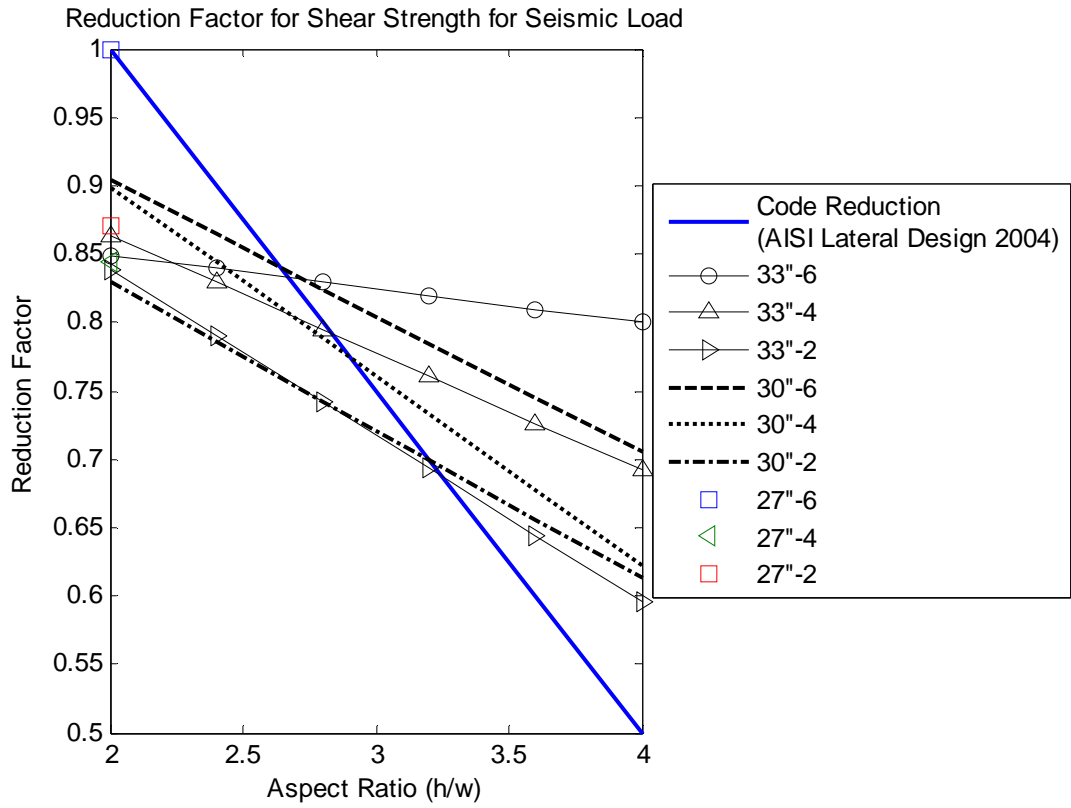

Figure 34 Reduction factors for shear strength for seismic loads

Comparison with the Test Results of other Researchers

Serrette (1997) performed monotonic and cyclic tests on 0.027-in. sheet steel walls with aspect ratio of 4:1. In this research performed at UNT (Yu, 2007), 0.027-in. sheet steel walls with 2:1 aspect ratio were studied. Further, the fasteners in Serrette’s tests were installed on the inner flanges of the boundary studs therefore the actual width of the wall assemblies is 4-ft. plus 2 times of the width of the stud flanges. However in this test program, the width of the wall assemblies are all 4-ft., and the fasteners on the vertical edge of the sheathing were installed to the outer flanges of the boundary studs. Additionally, the cyclic test protocol are different in two test programs, SPD used in Serrette (1997), and CUREE used in this research. Therefore, indirect comparisons can be made between Serrette (1997) and this work, and Table 21 summarizes the results. It shows that the shear strengths of the 0.027-in. sheet steel walls tested from this research are significantly (average 30%) lower than the results tested by Serrette (1997).

Table 21 Indirect comparison with Serrette (1997) on nominal shear strength of 0.027” sheet steel walls

	Monotonic Test	Cyclic Test		Comments
	4”/12” Fastener Spacing	4”/12” Fastener Spacing	2”/12” Fastener Spacing	
Serrette (1997)	990 PLF	1003 PLF	1171 PLF	Wall aspect ratio 4:1 350S162-33 studs 350T125-33 tracks Grade 33 in framing and sheathing
Yu (2007)	684 PLF	710 PLF	845 PLF	Wall aspect ratio 2:1 350S162-33 studs 350T150-33 tracks Grade 33 in framing and sheathing

Recently, Ellis (2007) conducted a series of cyclic tests on 0.027-in. sheet steel walls. Ellis used 43-mil studs and 33-mil tracks for the wall assemblies. Originally, he had ordered 33-mil studs and track to match this test program. The material delivered met the requirement for minimum 33-mil thickness, and were stamped 33-mil; however, the measured thickness was comparable to that for a 43-mil designation thickness. He continued the test program using these thicker studs. In order to obtain a direct comparison between this test program and Ellis’, the test A-6 in the supporting group of this research was performed. Table 22 summarizes the comparison. This test program yields similar results as reported in Ellis (2007) on the same configuration of 0.027-in. sheet steel wall. The results also indicate that using thicker studs (43-mil vs. 33-mil) may improve the shear strength of 0.027-in. sheet steel walls significantly. This test program yielded 710-plf for 0.027-in. sheet steel walls with 33-mil framing and 907-plf for the same wall but with 43-mil studs and 33-mil tracks.

Table 22 Direct comparison with Ellis (2007) on nominal shear strength of 0.027” sheet steel walls

	Cyclic Test		Comments
	Nominal Shear Strength	Displacement at Nominal Strength	
Ellis (2007)	918 plf	1.34 in.	No. 8 × ½” sheathing screw spacing 4”/12” Wall aspect ratio 2:1 350S162-43 studs 350T125-33 tracks Grade 33 in framing and sheathing
Yu (2007)	907 plf	1.22 in.	

Ellis’ test program also investigated the cyclic test protocol: CUREE and SPD, and the hold-down installation configurations: raised from and flush to the base. Table 23 summarizes the specimen configurations and test results. It indicates that for steel framed shear walls with sheet steel sheathing, the CUREE protocol gives slightly higher (3.3% in Ellis’s tests) nominal shear strength than that obtained from SPD protocol. The relative position of hold-down to the base does not influence the ultimate strength of the wall assemblies, but the “Flush to base” setup may yield less displacement at nominal strength than the “Raised” configuration.

Table 23 Summary of test results and specimen configurations in Ellis (2007)

Configuration	Nominal Shear Strength	Displacement at Nominal Strength	Test Protocol	Hold-Down
1	918 plf	1.34 in.	CUREE	Raised
2	889 plf	0.897 in.	SPD	Flush
3	894 plf	1.18 in.	CUREE	Flush
No. 8 screw spacing 4”/12””; Wall aspect ratio 2:1; 350S162-43 studs; 350T125-33 tracks; Grade 33 in framing and sheathing. Two identical tests conducted for each configuration.				

It is important to notice that in this test program and the Ellis test program that certain framing and sheathing materials were ordered to a certain designation thickness, but the delivered thickness was greater. In this test program, the originally delivered sheet steel was ordered as a 27-mil designation thickness but what was delivered actually was comparable to the next larger 30-mil designation thickness; therefore, the PI requested a second delivery with materials more closely matching the desired thickness. In Ellis (2007)’s test program, the studs were ordered and marked as minimum 33-mil, but actually were comparable to the next larger 43-mil designation thickness. Thus it is important to check delivered materials before testing to ensure that the desired thickness has been received and perform tests on coupons cut from the original materials to verify mechanical properties.

Design Examples

Example 1 - Steel sheet sheathed, CFS framed Type I shear wall resisting seismic load (ASD)

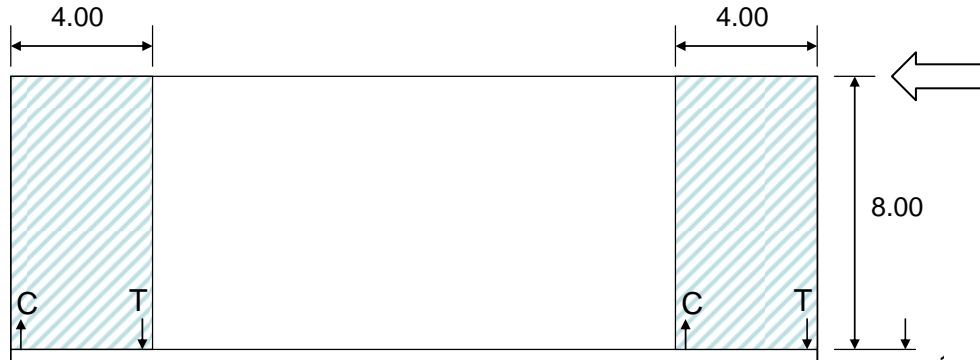

Required Shear Strength

Required allowable story strength V (ASD) = 3500 lbs

Total length of shear walls $\sum L_i = 4\text{ft} + 4\text{ft} = 8\text{ft}$

Required unit shear strength $v = V / \sum L_i = 438\text{plf}$

Shear wall aspect ratio = $8\text{ft} / 4\text{ft} = 2:1$

Use 0.033" steel sheet sheathing on one side of the shear walls with #8 screws at 4" o.c. nominal strength = $R_n = 1169\text{plf}$.

Shear wall seismic safety factor $\Omega = 2.5$

Available shear strength (ASD) $v = 1169 / \Omega = \mathbf{468\text{plf} > 438\text{plf}} \quad \mathbf{OK}$

Shear Anchorage at Bottom of Wall

2 - 1/2" dia. A307 bottom plate shear bolts ASD shear strength based on 43-mil bottom track = 1920 lbs (2002 AISI Manual CFS Design) > 1750 lbs OK

Required Overturning Strength

Shear wall moment arm $d = (4\text{ft} \times 12) - (1.5'' + 1.625'' + 1.625'') = 43.25''$

Shear wall height $h = 8\text{ft} \times 12 = 96\text{in.}$

Required shear strength $V_w = V / 2\text{ shear walls} = 1750\text{ lbs}$

Required overturning strength when $R < 3$ (AISI Lateral Standard C5)

$$T = C = V_w \times h / d = 1750 \times 96 / 43.25 = 3884\text{ lbs}$$

Required overturning strength when $R > 3$ (AISI Lateral Standard C5). Use lesser of:

- Over-strength factor $T = C = \text{LRFD OT} \times \Omega_o = 3884 \times 1.4 \times 3.0 = 16312 \text{ lbs}$
or
- Maximum system can deliver $V_n = 1169 \times 4 \text{ ft} = 4676 \text{ lbs}$,
 $T = C = V_n \times h / d = \underline{10379 \text{ lbs}}$

Boundary Element

$h = 8 \text{ ft}$

$C = 10379 \text{ lbs}$ (AISI-Lateral C5.3 – Max. system can deliver)

Use (2) 350S162-43 ($F_y=33 \text{ ksi}$) studs with bracing at 1/3-height points.

Nominal compression strength, P_n , from 2002 AISI Manual Table III -5

$P_n = 5990 \times 2 \text{ studs} = \underline{11980 \text{ lbs} > 10379 \text{ lbs OK}}$

Overturning Restraint Resisting Maximum System Can Deliver

$T = 10379 \text{ lbs}$

Use Simpson Strong-Tie S/HD8S hold-down to 2-43 mil back to back boundary studs

Nominal tensile strength = **20,704 lbs > 10379 lbs OK**

7/8 in. dia. A307 or A36 anchor bolt

AISC 360-05 J3.6

$R_n = F_n A_b = (0.75 \times 58 \text{ ksi}) \times 0.601 \text{ in}^2 = \underline{26144 \text{ lbs} > 10379 \text{ lbs OK}}$

Check Story Drift per Code Limitation

$$\delta = \frac{8vh^3}{E_s A_c b} + \omega_1 \omega_2 \frac{vh}{\rho G t_{\text{sheathing}}} + \omega_1^{5/4} \omega_2 \omega_3 \omega_4 \left(\frac{v}{\beta} \right)^2 + \delta_a$$

$$\frac{8vh^3}{E_s A_c b} = \frac{8(438\text{plf})(8\text{ft})^3}{(29500000\text{psi})(0.334\text{in}^2)(4\text{ft})} = 0.068''$$

$$\omega_1 \omega_2 \frac{vh}{\rho G t_{\text{sheathing}}} = \frac{(0.67)(0.767)(438\text{plf})(8\text{ft})}{(0.1375)(11500000\text{psi})(0.033\text{in.})} = 0.0345''$$

$$\omega_1^{5/4} \omega_2 \omega_3 \omega_4 \left(\frac{v}{\beta} \right)^2 = (0.67)^{5/4} (0.767)(1)(1) \left(\frac{438}{917} \right)^2 = 0.106''$$

$T_{\text{ASD}} = 3884 \text{ lbs}$

S/HD8S hold-down deflection at 3884 lbs is $3884 \text{ lbs} \times 0.0960 \text{ in.} / 11070 \text{ lbs} = 0.034''$

$$\delta_a = \frac{h}{b}(0.034\text{in.}) = \frac{8}{4}(0.034\text{in.}) = 0.068''$$

$$\delta = \frac{8vh^3}{E_s A_c b} + \omega_1 \omega_2 \frac{vh}{\rho G t_{\text{sheathing}}} + \omega_1^{5/4} \omega_2 \omega_3 \omega_4 \left(\frac{v}{\beta} \right)^2 + \delta_a$$

$$= \underline{\underline{0.277''}} < \text{IBC seismic drift limit} = 0.025 \text{ H} / \text{Cd } 1.4 = 0.43'' \quad \text{OK}$$

Example 2 - Steel sheet sheathed, CFS framed Type I shear wall resisting seismic load (ASD)

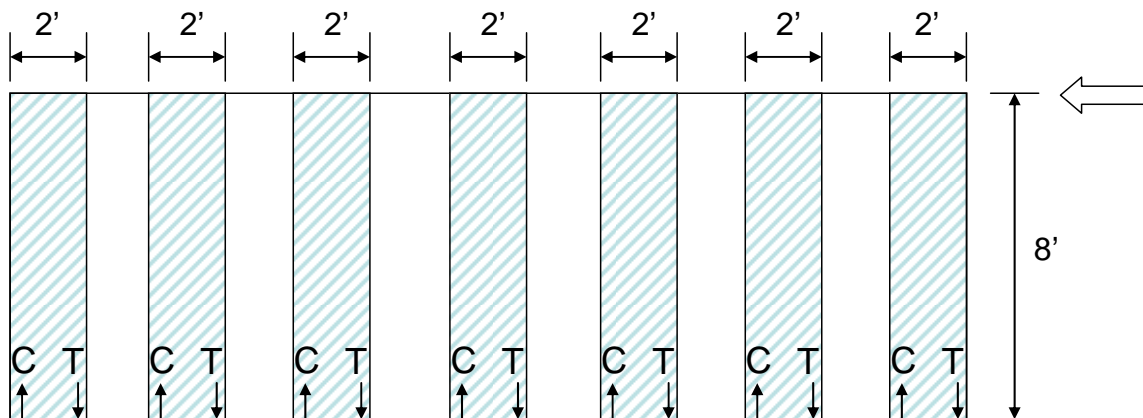

Required Shear Strength

Required allowable story strength V (ASD) = 3500 lbs

Total length of shear walls $\sum L_i = 7 \times 2\text{ft} = 14\text{ft}$

Required unit shear strength $v = V / \sum L_i = 250\text{plf}$

Shear wall aspect ratio = $8\text{ ft} / 2\text{ ft} = 4:1$

Use 0.033" steel sheet sheathing on one side of the shear walls with #8 screws at 2" o.c. nominal strength = $R_n = 1304 \times (2w/h) = 1304(2 \times 2/8) = 652\text{ plf}$.

Shear wall seismic safety factor $\Omega = 2.5$

Available shear strength (ASD) $v = 652 / \Omega = \underline{\underline{261\text{ plf} > 250\text{ plf}}}$ **OK**

Shear Anchorage at Bottom of Wall

2 - 1/2" dia. A307 bottom plate shear bolts ASD shear strength based on 43-mil bottom track = 1920 lbs (2002 AISI Manual CFS Design) > 500 lbs OK

Required Overturning Strength

Shear wall moment arm $d = (2\text{ ft} \times 12) - (1.5'' + 1.625'' + 1.625'') = 19.25''$

Shear wall height $h = 8\text{ ft} \times 12 = 96\text{ in.}$

Required shear strength $V_w = V / 7\text{ shear walls} = 500\text{ lbs}$

Required overturning strength when $R < 3$ (AISI Lateral Standard C5)

$$T = C = V_w \times h / d = 500 \times 96 / 19.25 = 2494\text{ lbs}$$

Required overturning strength when $R > 3$ (AISI Lateral Standard C5). Use lesser of:

1. Over-strength factor $T = C = \text{LRFD OT} \times \Omega_o = 2494 \times 1.4 \times 3.0$
 $= 10475 \text{ lbs}$

or

2. Maximum system can deliver $V_n = 652 \times 2 \text{ ft} = 1304 \text{ lbs},$
 $T = C = V_n \times h / d = \underline{6503 \text{ lbs}}$

Boundary Element

$h = 8 \text{ ft}$

$C = 10379 \text{ lbs}$ (AISI-Lateral C5.3 – Max. system can deliver)

Use (2) 350S162-43 ($F_y=33 \text{ ksi}$) studs with bracing at mid-height.

Nominal compression strength, P_n , from 2002 AISI Manual Table III -5

$P_n = 5040 \times 2 \text{ studs} = \underline{10080 \text{ lbs} > 6503 \text{ lbs}} \quad \text{OK}$

Overturning Restraint Resisting Maximum System Can Deliver

$T = 6503 \text{ lbs}$

Use Simpson Strong-Tie S/HD8S hold-down with 10 #14 screws to 2-43 mil back to back boundary studs

Nominal tensile strength = 11070 lbs (10/17) = 6511 lbs > 6503 lbs **OK**

1/2 in. dia. A307 or A36 anchor bolt

AISC 360-05 J3.6

$R_n = F_n A_b = (0.75 \times 58 \text{ ksi}) \times 0.196 \text{ in}^2 = \underline{8526 \text{ lbs} > 6503 \text{ lbs}} \quad \text{OK}$

Check Story Drift per Code Limitation

$$\delta = \frac{8vh^3}{E_s A_c b} + \omega_1 \omega_2 \frac{vh}{\rho G t_{\text{sheathing}}} + \omega_1^{5/4} \omega_2 \omega_3 \omega_4 \left(\frac{v}{\beta} \right)^2 + \delta_a$$

$$\frac{8vh^3}{E_s A_c b} = \frac{8(250\text{plf})(8\text{ft})^3}{(29500000\text{psi})(0.334\text{in}^2 \times 2)(2\text{ft})} = 0.026''$$

$$\omega_1 \omega_2 \frac{vh}{\rho G t_{\text{sheathing}}} = \frac{(0.33)(0.767)(250\text{plf})(8\text{ft})}{(0.1375)(11500000\text{psi})(0.033\text{in.})} = 0.010''$$

$$\omega_1^{5/4} \omega_2 \omega_3 \omega_4 \left(\frac{v}{\beta} \right)^2 = (0.333)^{5/4} (0.767)(1.414)(1) \left(\frac{250}{917} \right)^2 = 0.020''$$

$T_{\text{ASD}} = 3884 \text{ lbs}$

S/HD8S hold-down deflection at 2494 lbs is $2494 \text{ lbs} \times 0.0960 \text{ in.} / 6511 \text{ lbs} = 0.037''$

$$\delta_a = \frac{h}{b}(0.037\text{in.}) = \frac{8}{2}(0.037\text{in.}) = 0.148''$$

$$\delta = \frac{8vh^3}{E_s A_c b} + \omega_1 \omega_2 \frac{vh}{\rho G t_{\text{sheathing}}} + \omega_1^{5/4} \omega_2 \omega_3 \omega_4 \left(\frac{v}{\beta} \right)^2 + \delta_a$$

$$= \underline{\underline{0.204'' < \text{IBC seismic drift limit} = 0.025 H / Cd 1.4 = 0.43'' \quad \text{OK}}}$$

CONCLUSIONS AND FUTURE RESEARCH

Monotonic and cyclic shear wall tests on cold-formed steel stud walls with steel sheet sheathing on one side were conducted, and the nominal shear strengths for wind loads and seismic loads were determined from the test results.

It was discovered in this project that use of No. 10 \times $\frac{3}{4}$ " flat truss self-drilling tapping screws did not significantly improve the shear resistance of the sheet steel wall assemblies because the shear failure of the fasteners did not dominate the failure mechanism in the tests.

The flange distortion of the boundary studs was observed on the walls with 2"/12" screw spacing. Two alternative screw installation patterns were investigated in this research and it was found that a staggered screw pattern on both flanges of the boundary studs or installing screws on the inner flange of the boundary studs would slightly improve the shear strength of the walls and at the same time reduced the distortion of the stud flanges after tests. However the latter configuration requires a wider frame (sheathing width plus 2 times of the width of stud flange) than the nominal values. It is recommended the staggered fastener pattern to be applied to steel sheet walls with 2"/12" fastener spacing to mitigate against the failure on the studs. It is recommended to perform a comprehensive test program on the staggered fastener pattern with a 2"/12" spacing to determine if better performance could be achieved for the sheet steel walls.

Current AISI Lateral Standard (2004) employs a reduction factor $2w/h$ to account for the flexibility of narrow shear wall assemblies that have an aspect ratio exceeding 2:1. The test results indicate that the code reduction factor is a simple reduction factor that represents fairly well the strength reduction based on the drift limit for walls that have an aspect ratio between 2:1 and 4:1.

This project also discovered that thicker framing members may improve the shear strength of the steel sheet walls greatly. In this research, 43-mil framing members were used for 0.030-in. and 0.033-in. sheathing, and 33-mil framing members were used for 0.027-in. sheathing. It is recommended for the future research to study 0.030-in. and 0.033-in. sheet steel walls 54-mil or thicker framing members, and the 0.027-in. sheet steel walls with 43-mil or thicker framing members.

A discrepancy in the test results of this project, Serrette (1997), and Ellis (2007) for 0.027-in. sheet steel walls deserves further investigation. It is recommended that further tests to be conducted to insure the validity of the published shear strengths on wall assemblies with 0.018-in. sheet steel sheathing.

ACKNOWLEDGEMENT

The sponsorship of American Iron and Steel Institute and the donation of materials by Steel Stud Manufacturers Association and Simpson Strong-Tie Company, Inc. are gratefully acknowledged. The assistance and guidance provided by Jeff Ellis, Jay Larson, and the other AISI COFS Lateral Design Task Group members is highly appreciated. The assistance of the UNT lab technician Bobby Grimes in setting up the facilities has been invaluable.

REFERENCES

- AISC 360 (2005). "Specification for Structural Steel Buildings". American Institute of Steel Construction, Chicago, IL.
- AISI (2001). "North American Specification for Design of Cold-Formed Steel Structural Members 2001 Edition with 2004 Supplement" American Iron and Steel Institute, Washington, DC.
- AISI Lateral Standard (2004). "AISI Standard for Cold-Formed Steel Framing – Lateral Design 2004 Edition", American Iron and Steel Institute, Washington, DC.
- AISI Design Manual (2002). American Iron and Steel Institute, Washington, DC.
- ASCE 7 (2005) "Minimum Design Loads for Buildings And Other Structures: SEI/ASCE 7-05", American Society of Civil Engineers. Washington, DC.
- ASTM A370-06 (2006) "A370-06 Standard Test Methods and Definitions for Mechanical Testing of Steel Products", American Society for Testing and Materials, West Conshohocken, PA.
- ASTM E564-06 (2006). "E564-06 Standard Practice for Static Load Test for Shear Resistance of Framed Walls for Buildings", American Society for Testing and Materials, West Conshohocken, PA.
- ASME B18.22.1 (1998). "Plan Washers", American Society of Mechanical Engineers, New York, NY.
- Ellis, J. (2007). "Shear Resistance of Cold-Formed Steel Framed Shear Wall Assemblies using CUREE Test Protocol". Simpson Strong-Tie Co., Inc.
- IBC (2000). "2000 International Building Code", International Code Council, Inc., Washington, DC.
- IBC (2003). "2003 International Building Code", International Code Council, Inc., Washington, DC.
- ICC-ES AC130 (2004). "Acceptance Criteria for Prefabricated Wood Shear Panels", ICC Evaluation Service, Inc., Whittier, CA.
- Serrette, R.L., Nguyen, H., Hall, G. (1996). "Shear wall values for light weight steel framing." Report No. LGSRG-3-96, Santa Clara University. Santa Clara, CA.
- Serrette, R.L. (1997). "Additional Shear Wall Values for Light Weight Steel Framing." Report No. LGSRG-1-97, Santa Clara University. Santa Clara, CA.

Serrette, R.L. (2002). "Performance of Cold-Formed Steel-Framed Shear Walls: Alternative Configurations," Final Report:LGSRG-06-02, Santa Clara University.

UBC (1997). "1997 Uniform Building Code". International Conference of Building Official, Washington, DC.

APPENDIX A

DATA SHEETS OF MONOTONIC TESTS (MAIN GROUP)

Test Label 4x8x43x33-6/12-M1

Test Date March 21, 2007

Specimen Configuration

Wall dimensions: 4 ft. x 8 ft. Studs: 350S162-43, 24 in. o.c. Tracks: 350T150-43 Steel sheathing: 0.033 in.
Fastener: #8x18-1/2" modified truss head self-drilling tapping screw, 6 in. o.c. on the perimeter, 12 in. o.c. in the field.

Test protocol: Monotonic

Test results

Maximum load: 1023 plf
Lateral displacement at top of wall: 2.08 in.

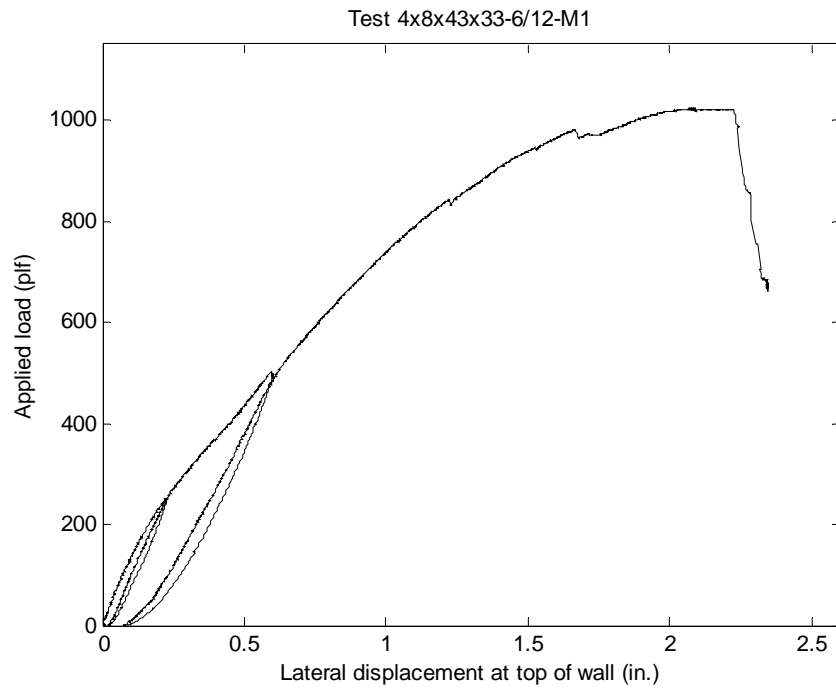

Observed Failure Mode: steel sheet buckled and pulled off the frame at the bottom of the loaded chord stud.



Test Label 4x8x43x33-6/12-M2

Test Date March 21, 2007

Specimen Configuration

Wall dimensions: 4 ft. x 8 ft. Studs: 350S162-43, 24 in. o.c. Tracks: 350T150-43 Steel sheathing: 0.033 in.
Fastener: #8x18-1/2" modified truss head self-drilling tapping screw, 6 in. o.c. on the perimeter, 12 in. o.c. in the field.

Test protocol: Monotonic

Test results

Maximum load: 1124 plf
Lateral displacement at top of wall:
1.72 in.

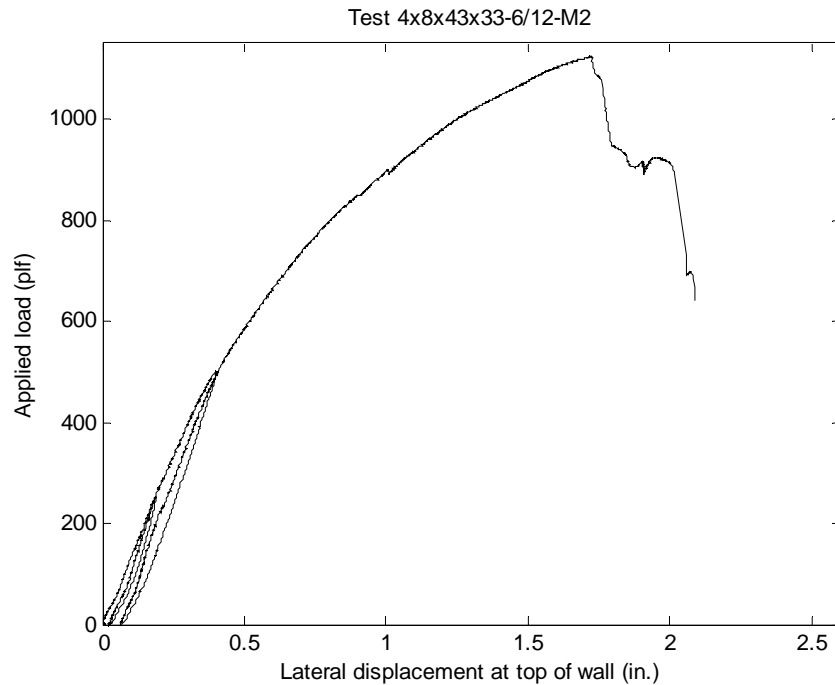

Observed Failure Mode: steel sheet buckled and pulled off the frame at the bottom corner of the wall on the loaded side.



Test Label 4x8x43x33-4/12-M1

Test Date March 22, 2007

Specimen Configuration

Wall dimensions: 4 ft. x 8 ft. Studs: 350S162-43, 24 in. o.c. Tracks: 350T150-43 Steel sheathing: 0.033 in.
Fastener: #8x18-1/2" modified truss head self-drilling tapping screw, 4 in. o.c. on the perimeter, 12 in. o.c. in the field.

Test protocol: Monotonic

Test results

Maximum load: 1173 plf
Lateral displacement at top of wall: 1.73 in.

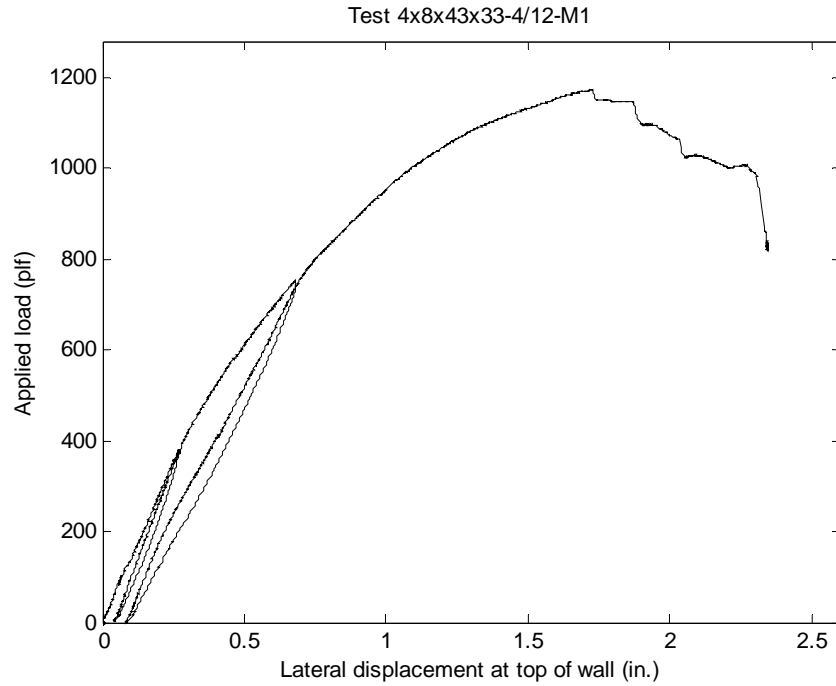

Observed Failure Mode: steel sheet buckled. At the lower corner of the wall on the loaded side, the flange of the outer stud and the bottom track distorted; two screws pulled out in the same area.



Test Label 4x8x43x33-4/12-M2

Test Date March 22, 2007

Specimen Configuration

Wall dimensions: 4 ft. × 8 ft. Studs: 350S162-43, 24 in. o.c. Tracks: 350T150-43 Steel sheathing: 0.033 in.
Fastener: #8×18-1/2" modified truss head self-drilling tapping screw, 4 in. o.c. on the perimeter, 12 in. o.c. in the field.

Test protocol: Monotonic

Test results

Maximum load: 1204 plf
Lateral displacement at top of wall: 2.32 in.

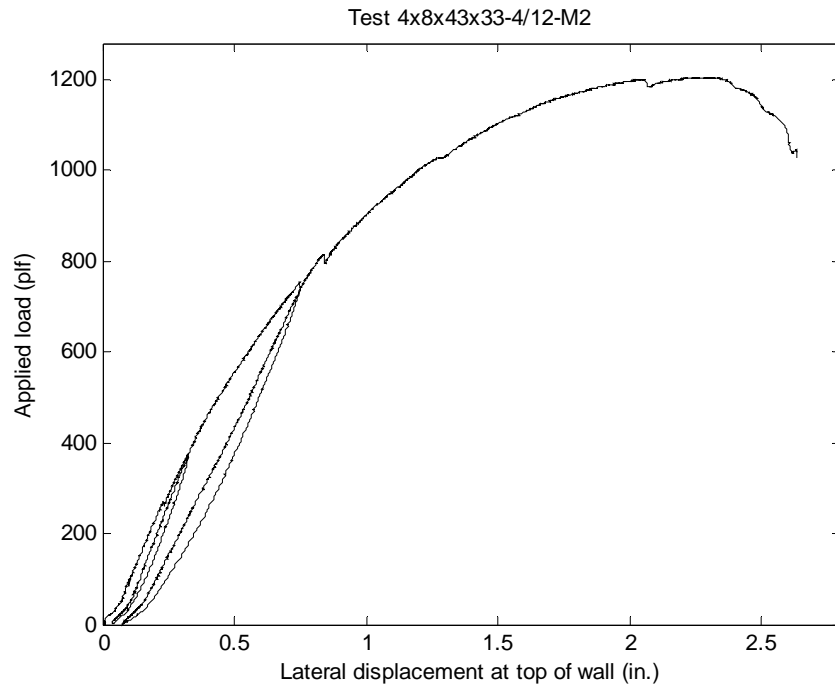

Observed Failure Mode: steel sheet buckled; the flange of the outer stud at the loaded side distorted.



Test Label 4x8x43x33-2/12-M1

Test Date March 22, 2007

Specimen Configuration

Wall dimensions: 4 ft. x 8 ft. Studs: 350S162-43, 24 in. o.c. Tracks: 350T150-43 Steel sheathing: 0.033 in.
Fastener: #8x18-1/2" modified truss head self-drilling tapping screw, 2 in. o.c. on the perimeter, 12 in. o.c. in the field.

Test protocol: Monotonic

Test results

Maximum load: 1317 plf
Lateral displacement at top of wall: 2.53 in.

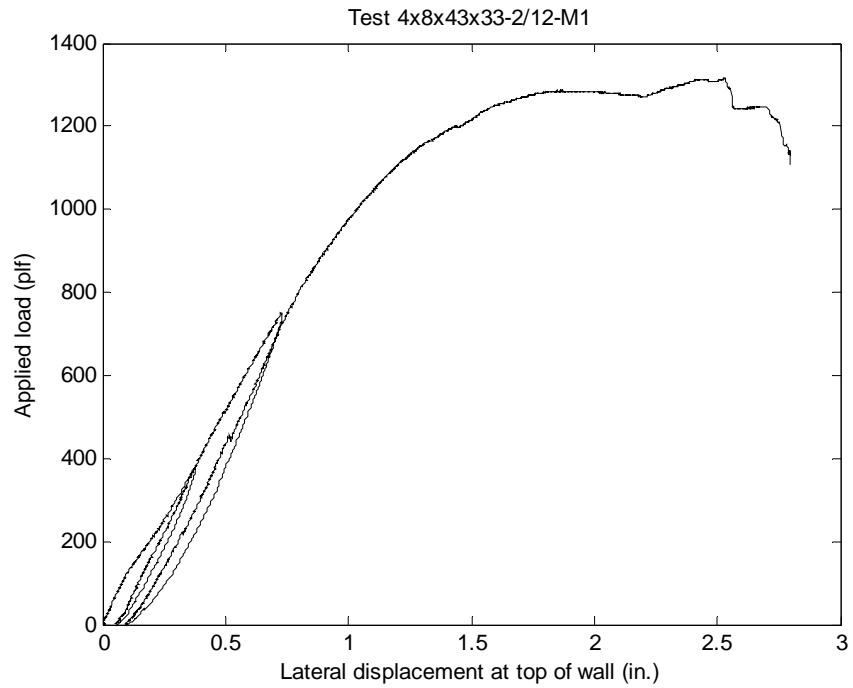

Observed Failure Mode: steel sheet buckled; the flange of the outer stud at the loaded side distorted, the bottom track distorted.



Test Label 4×8×43×33-2/12-M2

Test Date March 22, 2007

Specimen Configuration

Wall dimensions: 4 ft. × 8 ft. Studs: 350S162-43, 24 in. o.c. Tracks: 350T150-43 Steel sheathing: 0.033 in.
Fastener: #8×18-1/2" modified truss head self drilling screw, 2 in. o.c. on the perimeter, 12 in. o.c. in the field.

Test protocol: Monotonic

Test results

Maximum load: 1376 plf
Lateral displacement at top of wall: 1.65 in.

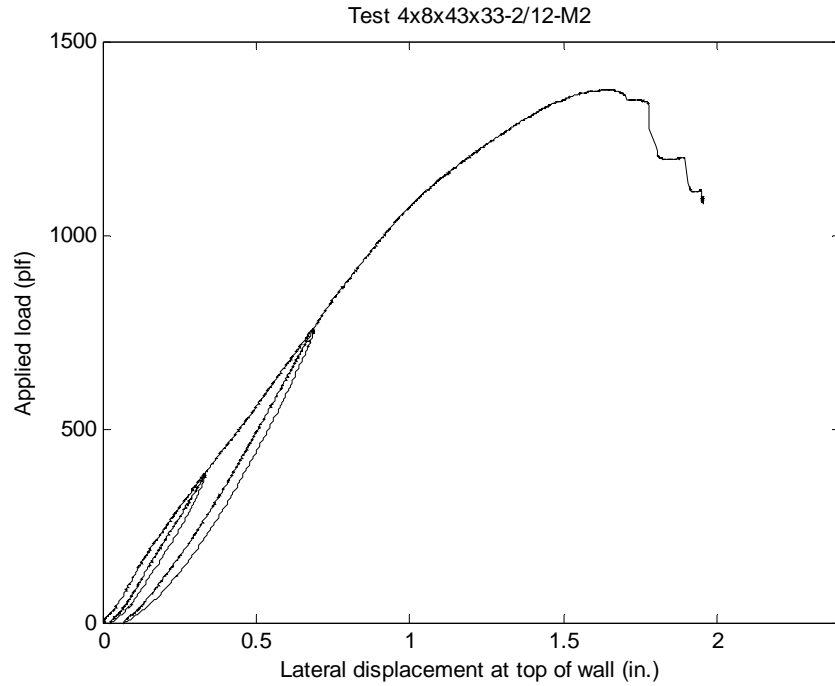

Observed Failure Mode: steel sheet buckled; the flange of the outer stud at the loaded side distorted; two screws at the lower corner pulled out.



Test Label 4×8×43×30-6/12-M1

Test Date February 16, 2007

Specimen Configuration

Wall dimensions: 4 ft. × 8 ft. Studs: 350S162-43, 24 in. o.c. Tracks: 350T150-43 Steel sheathing: 0.030 in.
Fastener: #8×18-1/2" modified truss head self-drilling tapping screw, 6 in. o.c. on the perimeter, 12 in. o.c. in the field.

Test protocol: Monotonic

Test results

Maximum load: 801 plf
Lateral displacement at top of wall:
2.51 in.

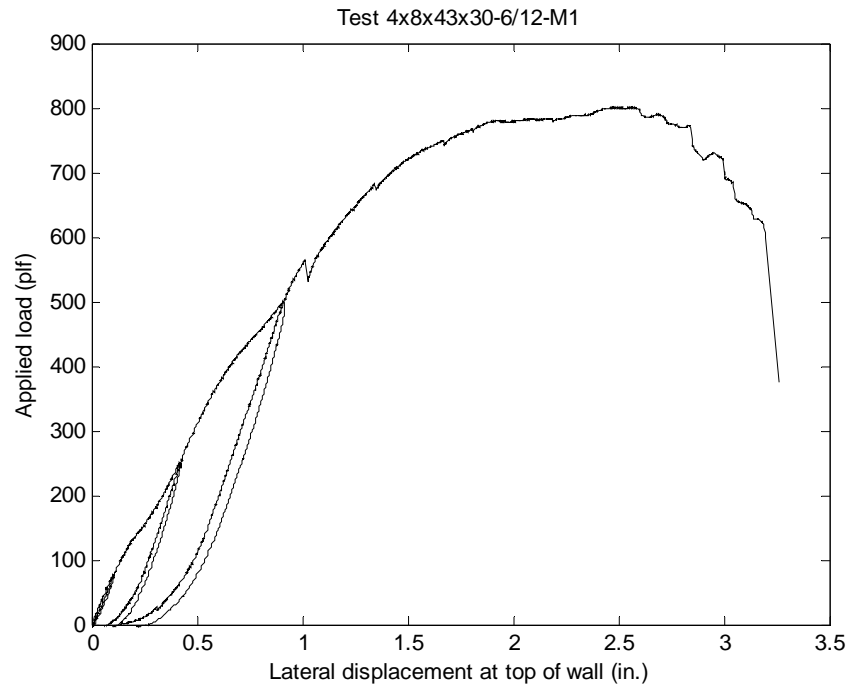

Observed Failure Mode: steel sheet buckled and pulled out at the lower corner at the loaded end



Test Label 4x8x43x30-6/12-M2

Test Date February 27, 2007

Specimen Configuration

Wall dimensions: 4 ft. x 8 ft. Studs: 350S162-43, 24 in. o.c. Tracks: 350T150-43 Steel sheathing: 0.030 in.
Fastener: #8x18-1/2" modified truss head self-drilling screw, 6 in. o.c. on the perimeter, 12 in. o.c. in the field.

Test protocol: Monotonic

Test results

Maximum load: 786 plf
Lateral displacement at top of wall: 2.43 in.

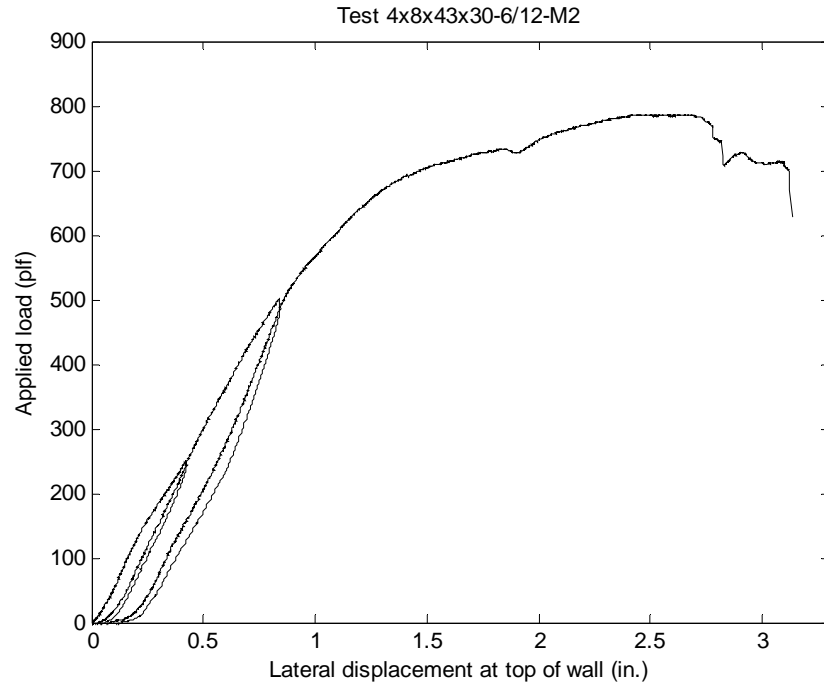

Observed Failure Mode: Steel sheet buckled and was ruptured by the screws at the lower corner on the loaded side

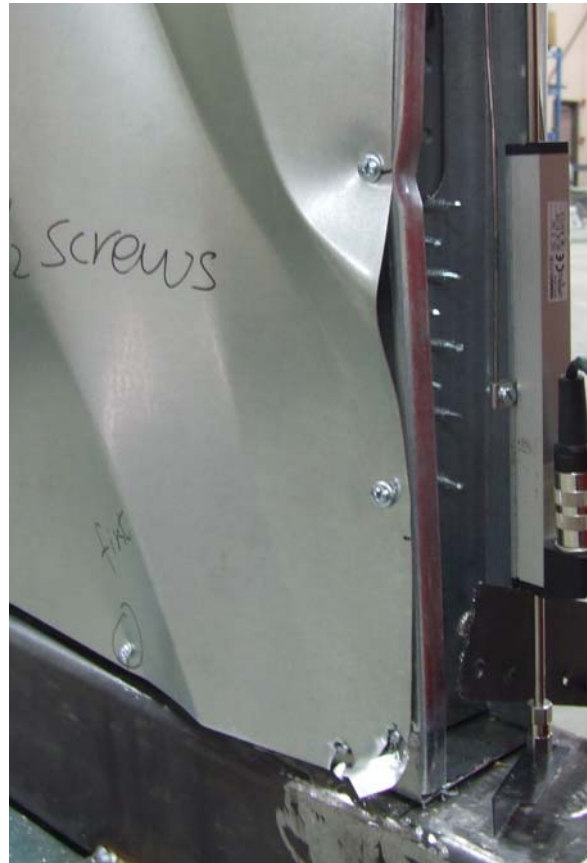

Test Label 4×8×43×30-4/12-M1

Test Date February 27, 2007

Specimen Configuration

Wall dimensions: 4 ft. × 8 ft. Studs: 350S162-43, 24 in. o.c. Tracks: 350T150-43 Steel sheathing: 0.030 in.
Fastener: #8×18-1/2" modified truss head self-drilling screw, 4 in. o.c. on the perimeter, 12 in. o.c. in the field.

Test protocol: Monotonic

Test results

Maximum load: 940 plf
Lateral displacement at top of wall:
2.47 in.

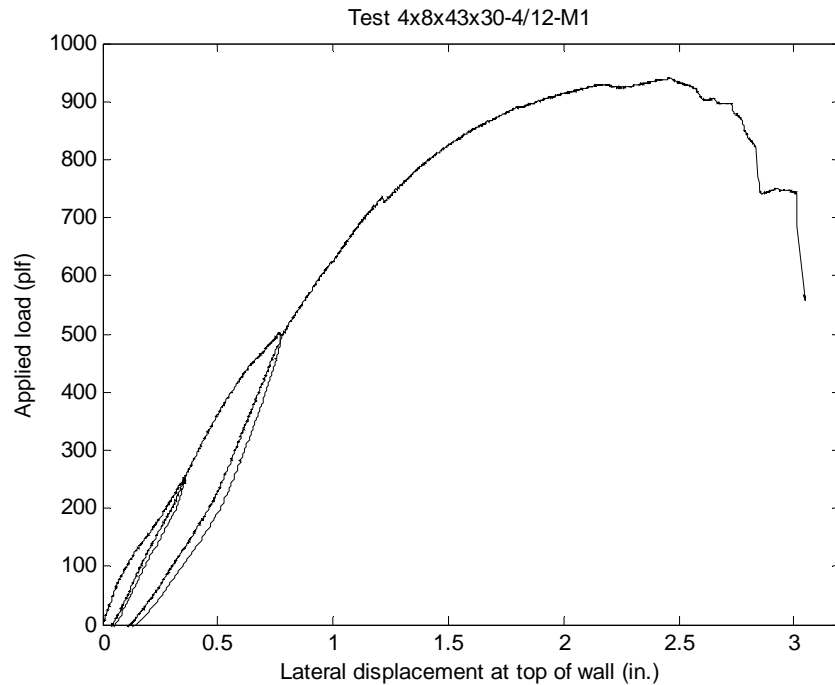

Observed Failure Mode: Steel sheet buckled and was ruptured by the screws at the lower corner on the loaded side

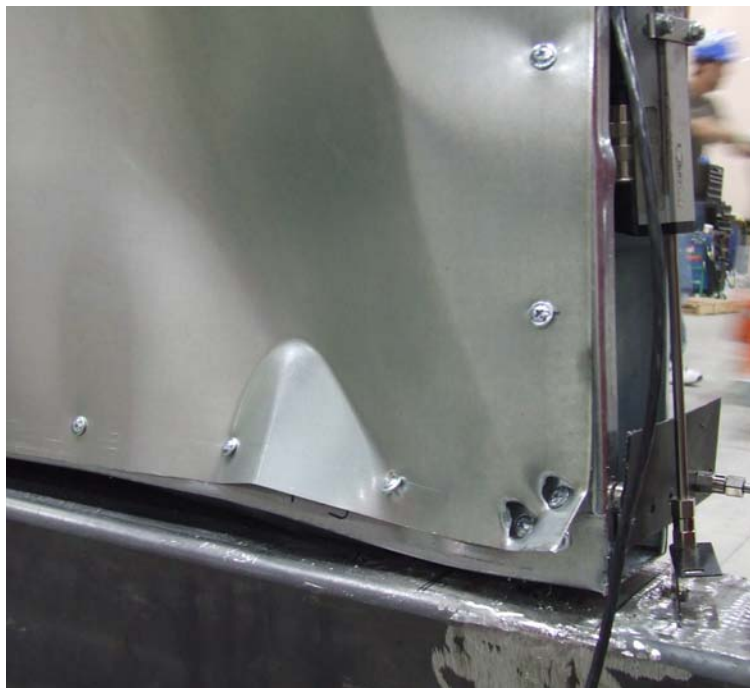

Test Label 4x8x43x30-4/12-M2

Test Date February 27, 2007

Specimen Configuration

Wall dimensions: 4 ft. x 8 ft. Studs: 350S162-43, 24 in. o.c. Tracks: 350T150-43 Steel sheathing: 0.030 in. thick
Fastener: #8x18-1/2" modified truss head self-drilling screw, 4 in. o.c. on the perimeter, 12 in. o.c. in the field.

Test protocol: Monotonic

Test results

Maximum load: 977 plf
Lateral displacement at top of wall: 2.76 in.

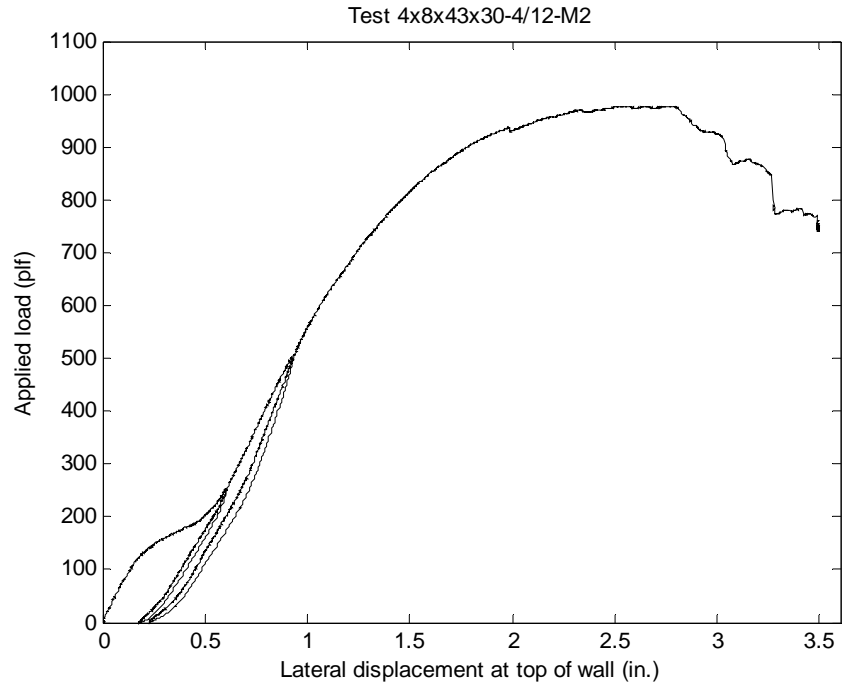

Observed Failure Mode: Steel sheet buckled and pulled of the frame at the lower corner on the loaded side



Test Label 4×8×43×30-2/12-M1

Test Date February 28, 2007

Specimen Configuration

Wall dimensions: 4 ft. × 8 ft. Studs: 350S162-43, 24 in. o.c. Tracks: 350T150-43 Steel sheathing: 0.030 in. thick
Fastener: #8×18-1/2" modified truss head self-drilling screw, 2 in. o.c. on the perimeter, 12 in. o.c. in the field.

Test protocol: Monotonic

Test results

Maximum load: 1078 plf
Lateral displacement at top of wall: 3.46 in.

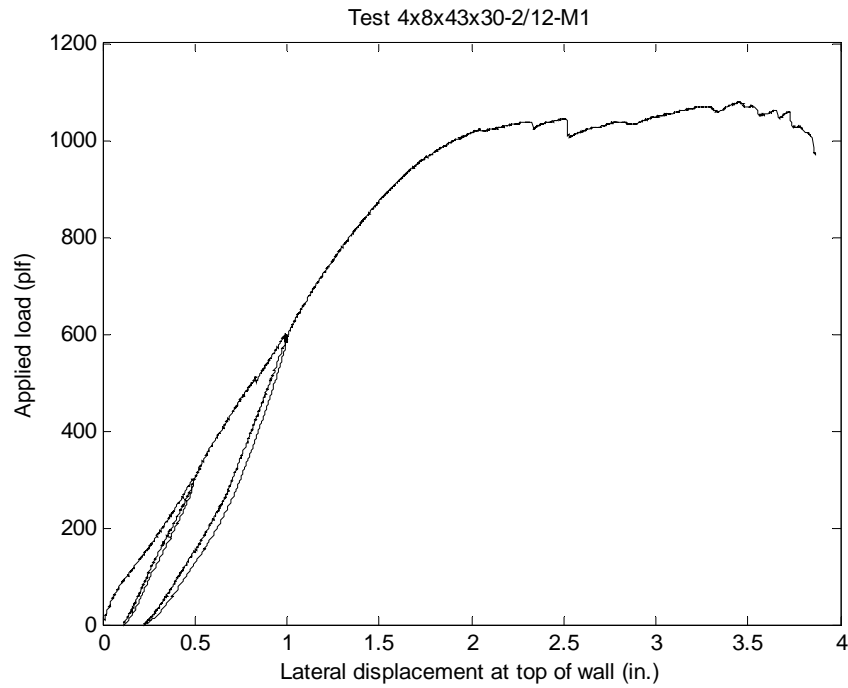

Observed Failure Mode: Steel sheet buckled, the flange of the outer stud at the loaded side distorted.



Test Label 4x8x43x30-2/12-M2

Test Date February 28, 2007

Specimen Configuration

Wall dimensions: 4 ft. x 8 ft. Studs: 350S162-43, 24 in. o.c. Tracks: 350T150-43 Steel sheathing: 0.030 in. thick
Fastener: #8x18-1/2" modified truss head self-drilling screw, 2 in. o.c. on the perimeter, 12 in. o.c. in the field.

Test protocol: Monotonic

Test results

Maximum load: 1030 plf
Lateral displacement at top of wall: 2.94 in.

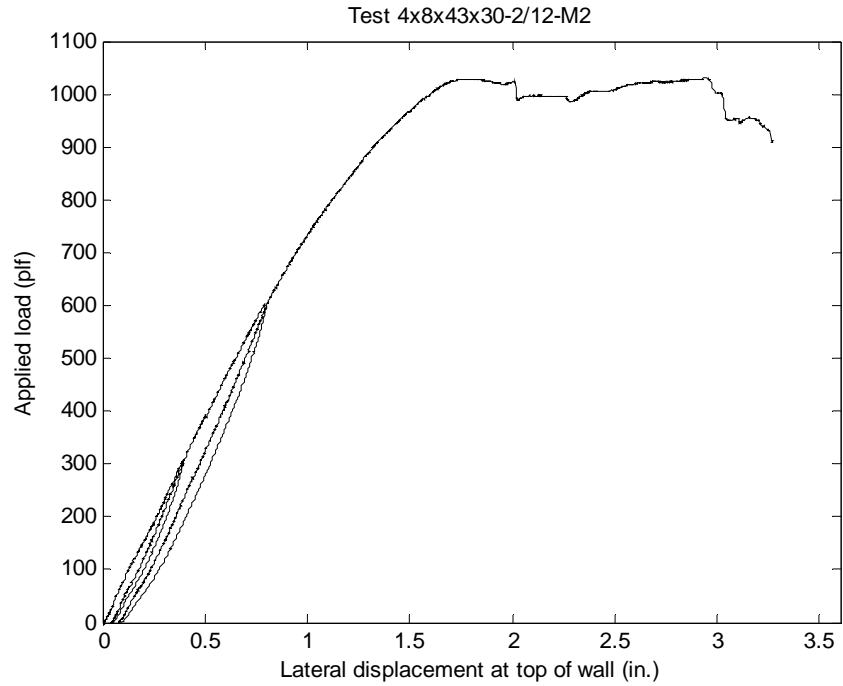

Observed Failure Mode: Steel sheet buckled; the flange of the outer stud and the bottom track buckled at the lower corner of the wall on the loaded side.

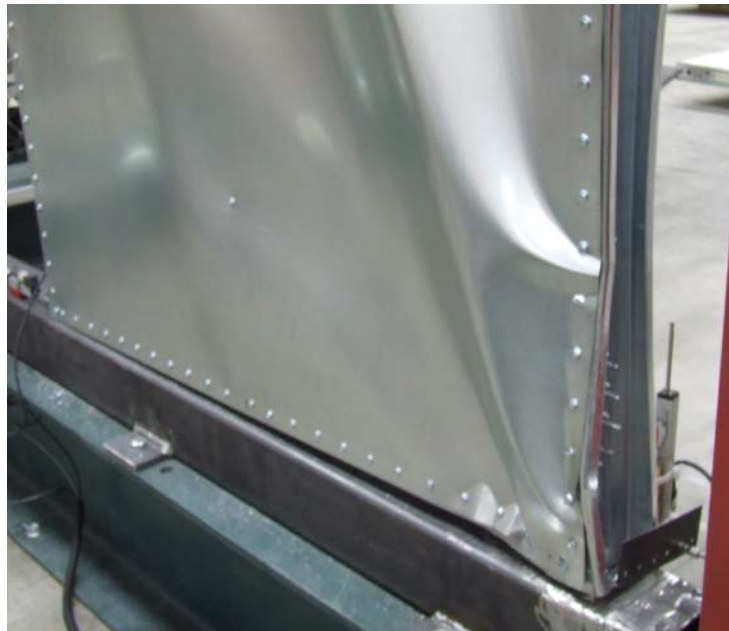

Test Label 4x8x33x27-6/12-M1

Test Date March 20, 2007

Specimen Configuration

Wall dimensions: 4 ft. x 8 ft. Studs: 350S162-33, 24 in. o.c. Tracks: 350T150-33 Steel sheathing: 0.027 in. thick
Fastener: #8x18-1/2" modified truss head self-drilling screw, 6 in. o.c. on the perimeter, 12 in. o.c. in the field.

Test protocol: Monotonic

Test results

Maximum load: 644 plf
Lateral displacement at top of wall:
1.87 in.

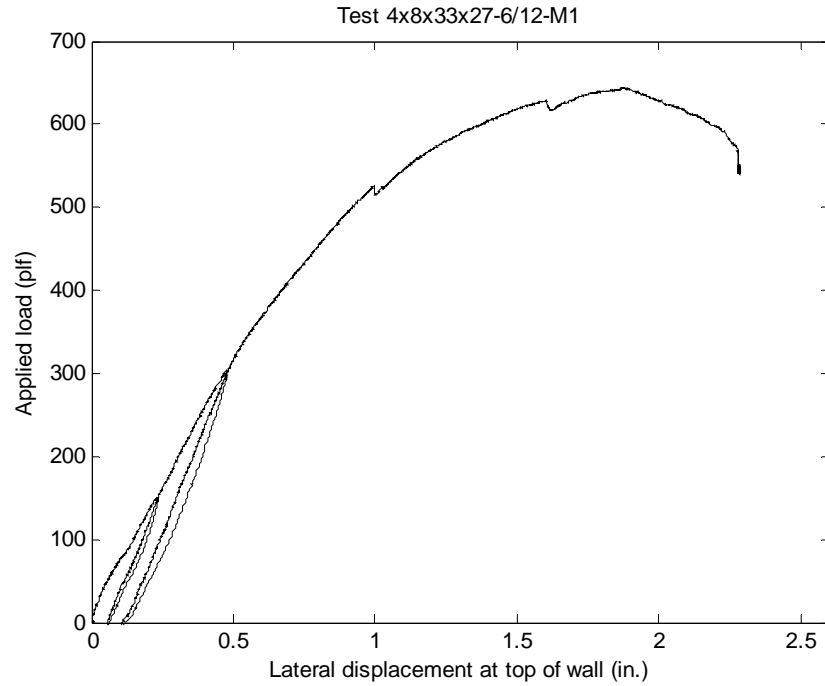

Observed Failure Mode: Steel sheet buckled.



Test Label 4x8x33x27-6/12-M2

Test Date March 20, 2007

Specimen Configuration

Wall dimensions: 4 ft. x 8 ft. Studs: 350S162-33, 24 in. o.c. Tracks: 350T150-33 Steel sheathing: 0.027 in. thick
Fastener: #8x18-1/2" modified truss head self-drilling screw, 6 in. o.c. on the perimeter, 12 in. o.c. in the field.

Test protocol: Monotonic

Test results

Maximum load: 607 plf
Lateral displacement at top of wall:
1.95 in.

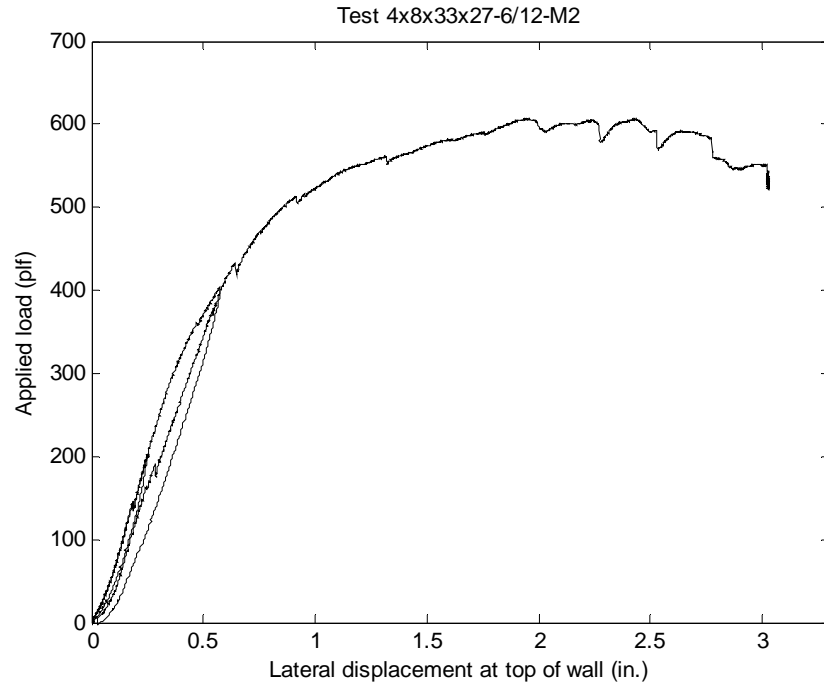

Observed Failure Mode: Steel sheet buckled.



Test Label 4x8x33x27-4/12-M1

Test Date March 20, 2007

Specimen Configuration

Wall dimensions: 4 ft. x 8 ft. Studs: 350S162-33, 24 in. o.c. Tracks: 350T150-33 Steel sheathing: 0.027 in. thick
Fastener: #8x18-1/2" modified truss head self-drilling screw, 4 in. o.c. on the perimeter, 12 in. o.c. in the field.

Test protocol: Monotonic

Test results

Maximum load: 685 plf
Lateral displacement at top of wall:
1.90 in.

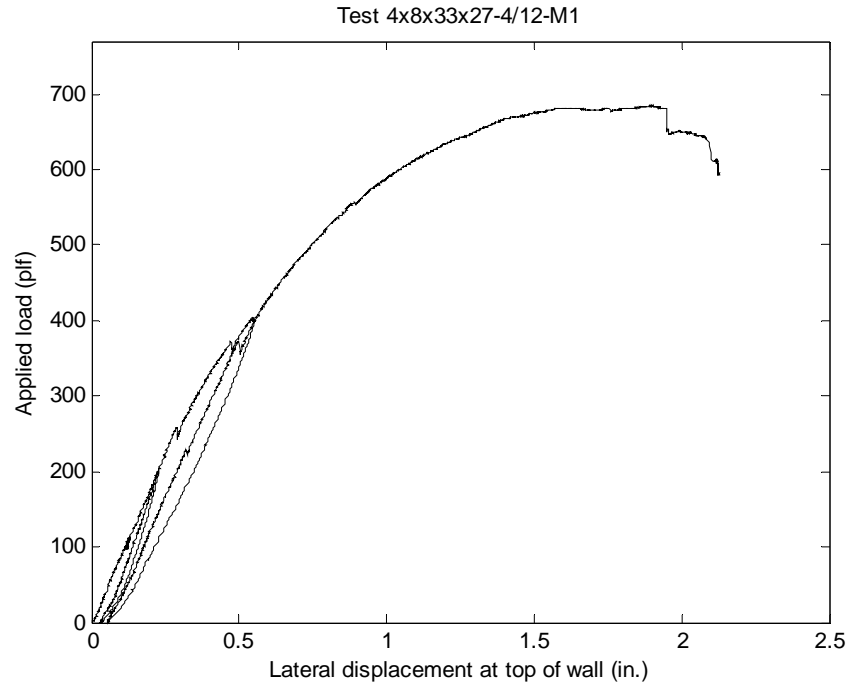

Observed Failure Mode: Steel sheet buckled.



Test Label 4x8x33x27-4/12-M2

Test Date March 20, 2007

Specimen Configuration

Wall dimensions: 4 ft. x 8 ft. Studs: 350S162-33, 24 in. o.c. Tracks: 350T150-33 Steel sheathing: 0.027 in. thick
Fastener: #8x18-1/2" modified truss head self-drilling screw, 4 in. o.c. on the perimeter, 12 in. o.c. in the field.

Test protocol: Monotonic

Test results

Maximum load: 682 plf
Lateral displacement at top of wall: 2.31 in.

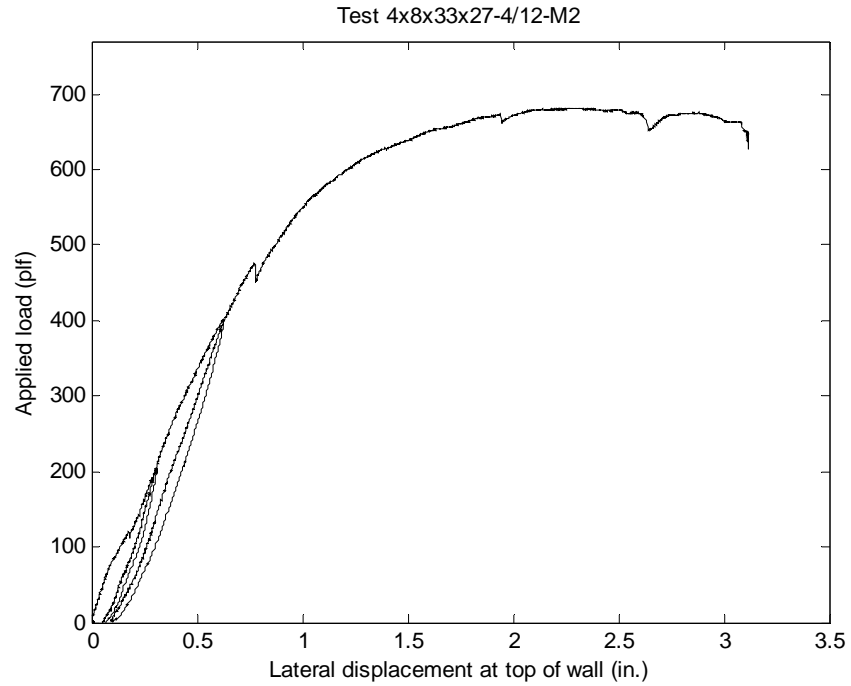

Observed Failure Mode: Steel sheet buckled.



Test Label 4×8×33×27-2/12-M1

Test Date March 21, 2007

Specimen Configuration

Wall dimensions: 4 ft. × 8 ft. Studs: 350S162-33, 24 in. o.c. Tracks: 350T150-33 Steel sheathing: 0.027 in. thick
Fastener: #8×18-1/2" modified truss head self-drilling screw, 2 in. o.c. on the perimeter, 12 in. o.c. in the field.

Test protocol: Monotonic

Test results

Maximum load: 856 plf
Net lateral displacement at top of wall: 2.02 in.

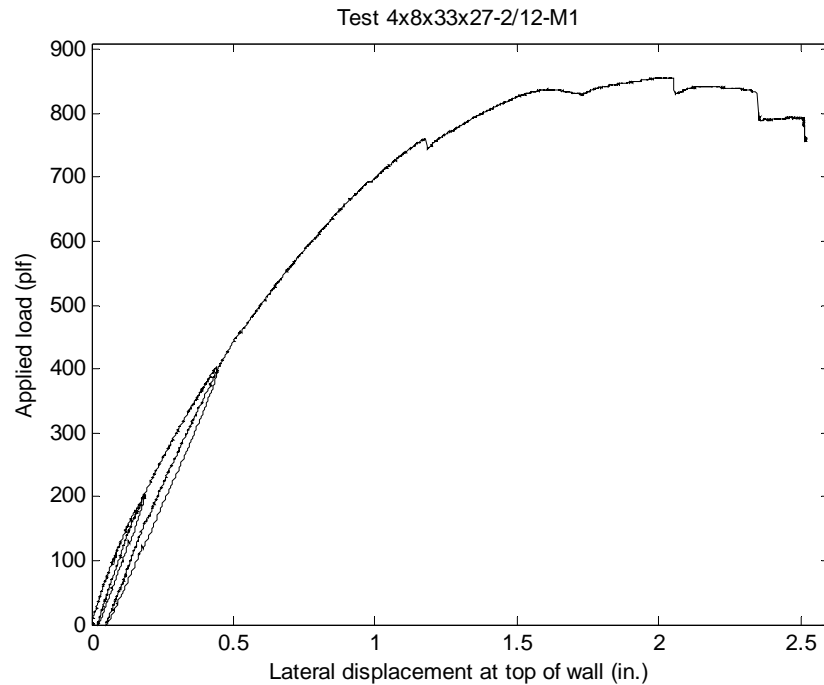

Observed Failure Mode: Steel sheet buckled, the flange of the outer stud at the loaded side distorted at the bottom portion.



Test Label 4x8x33x27-2/12-M2

Test Date March 21, 2007

Specimen Configuration

Wall dimensions: 4 ft. x 8 ft. Studs: 350S162-33, 24 in. o.c. Tracks: 350T150-33 Steel sheathing: 0.027 in. thick
Fastener: #8x18-1/2" modified truss head self-drilling screw, 2 in. o.c. on the perimeter, 12 in. o.c. in the field.

Test protocol: Monotonic

Test results

Maximum load: 816 plf
Lateral displacement at top of wall: 1.96 in.

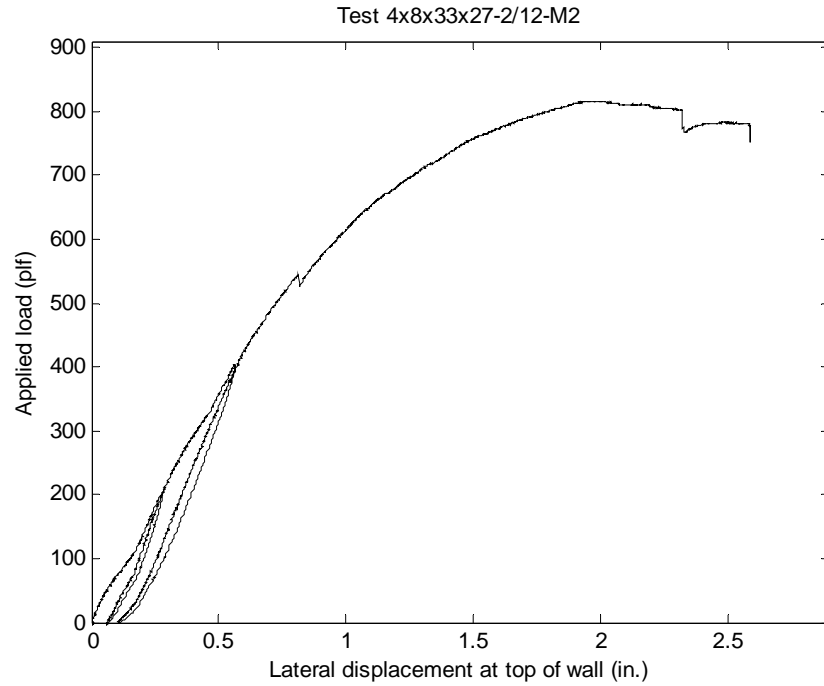

Observed Failure Mode: Steel sheet buckled, the flange of the outer stud at the loaded side distorted at the bottom portion.



Test Label 2x8x43x33-6-M1

Test Date March 26, 2007

Specimen Configuration

Wall dimensions: 2 ft. x 8 ft.

Studs: 350S162-43, 24 in. o.c.

Tracks: 350T150-43

Steel sheathing: 0.033 in. thick

Fastener: #8x18-1/2" modified truss head self-drilling screw, 6 in. o.c. on the perimeter.

Test protocol: Monotonic

Test results

Maximum load: 1065 plf

Net lateral displacement at top of wall: 3.13 in.

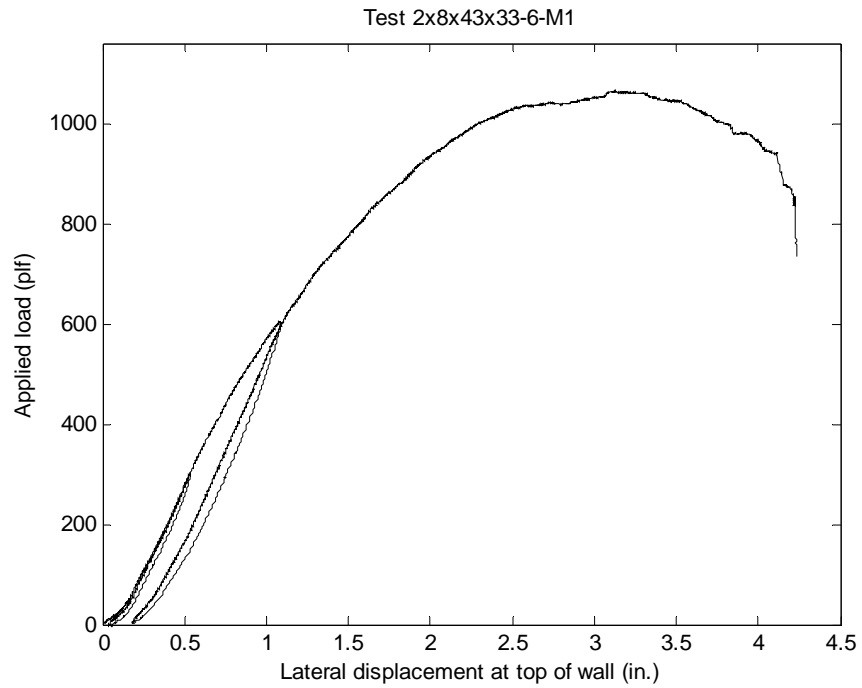

Observed Failure Mode: Steel sheet buckled.



Test Label 2x8x43x33-6-M2

Test Date March 26, 2007

Specimen Configuration

Wall dimensions: 2 ft. x 8 ft. Studs: 350S162-43, 24 in. o.c. Tracks: 350T150-43 Steel sheathing: 0.033 in. thick
Fastener: #8x18-1/2" modified truss head self-drilling screw, 6 in. o.c. on the perimeter.

Test protocol: Monotonic

Test results

Maximum load: 968 plf
Net lateral displacement at top of wall: 2.47 in.

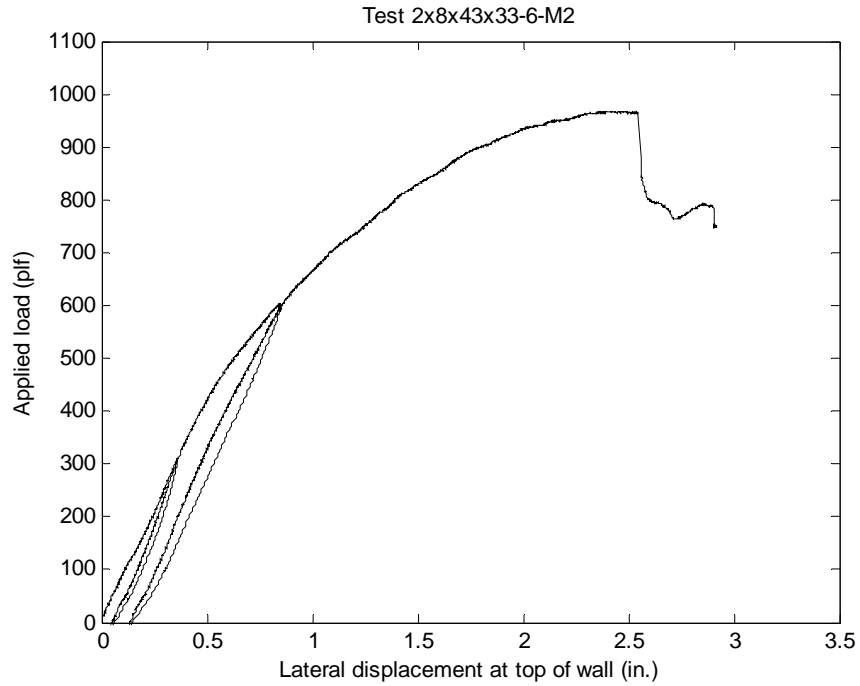

Observed Failure Mode: Steel sheet buckled; one screw pulled out from the loaded chord stud at the bottom area.



Test Label 2x8x43x33-4-M1

Test Date March 24, 2007

Specimen Configuration

Wall dimensions: 2 ft. x 8 ft. Studs: 350S162-43, 24 in. o.c. Tracks: 350T150-43 Steel sheathing: 0.033 in. thick
Fastener: #8x18-1/2" modified truss head self-drilling screw, 4 in. o.c. on the perimeter.

Test protocol: Monotonic

Test results

Maximum load: 1147 plf
Net lateral displacement at top of wall: 2.63 in.

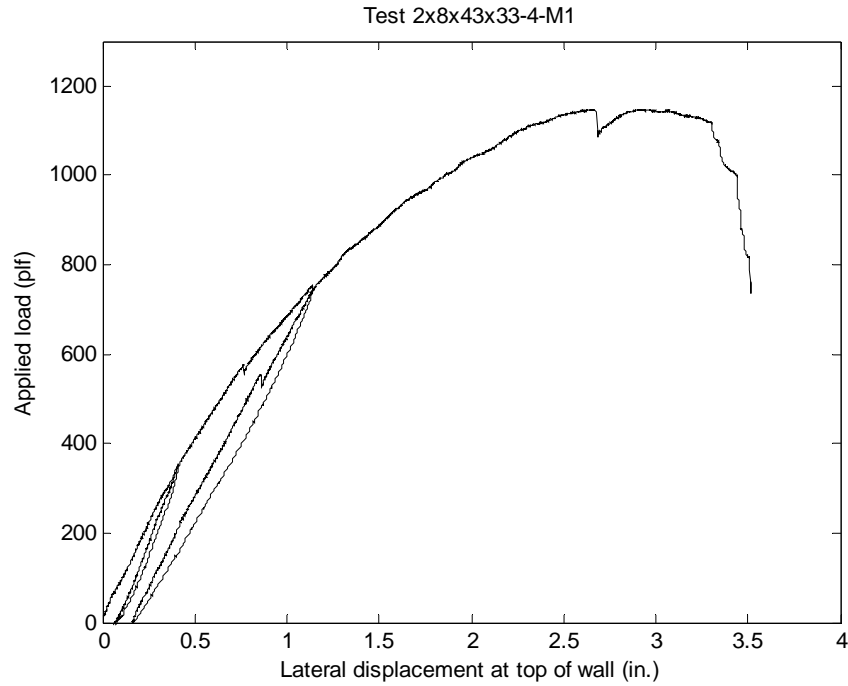

Observed Failure Mode: Steel sheet buckled; screws at the lower corner on the loaded side pulled out from frame.



Test Label 2x8x43x33-4-M2

Test Date March 24, 2007

Specimen Configuration

Wall dimensions: 2 ft. x 8 ft. Studs: 350S162-43, 24 in. o.c. Tracks: 350T150-43 Steel sheathing: 0.033 in. thick
Fastener: #8x18-1/2" modified truss head self-drilling screw, 4 in. o.c. on the perimeter.

Test protocol: Monotonic

Test results

Maximum load: 1164 plf
Net lateral displacement at top of wall: 2.91 in.

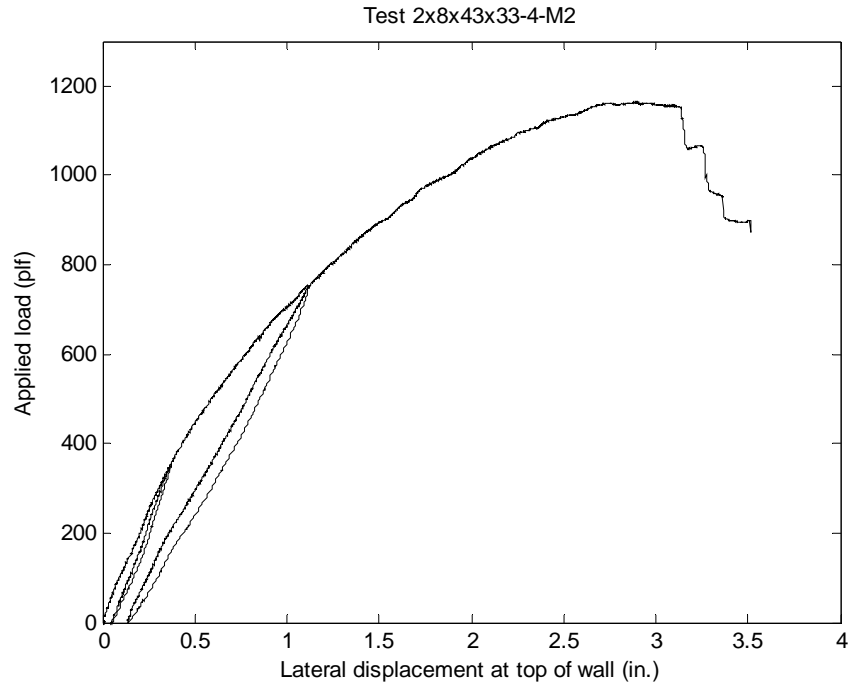

Observed Failure Mode: Steel sheet buckled; screws at the lower corner on the loaded side pulled out from frame.



Test Label 2x8x43x33-2-M1

Test Date March 24, 2007

Specimen Configuration

Wall dimensions: 2 ft. x 8 ft. Studs: 350S162-43, 24 in. o.c. Tracks: 350T150-43 Steel sheathing: 0.033 in. thick
Fastener: #8x18-1/2" modified truss head self-drilling screw, 2 in. o.c. on the perimeter.

Test protocol: Monotonic

Test results

Maximum load: 1386 plf
Net lateral displacement at top of wall: 3.35 in.

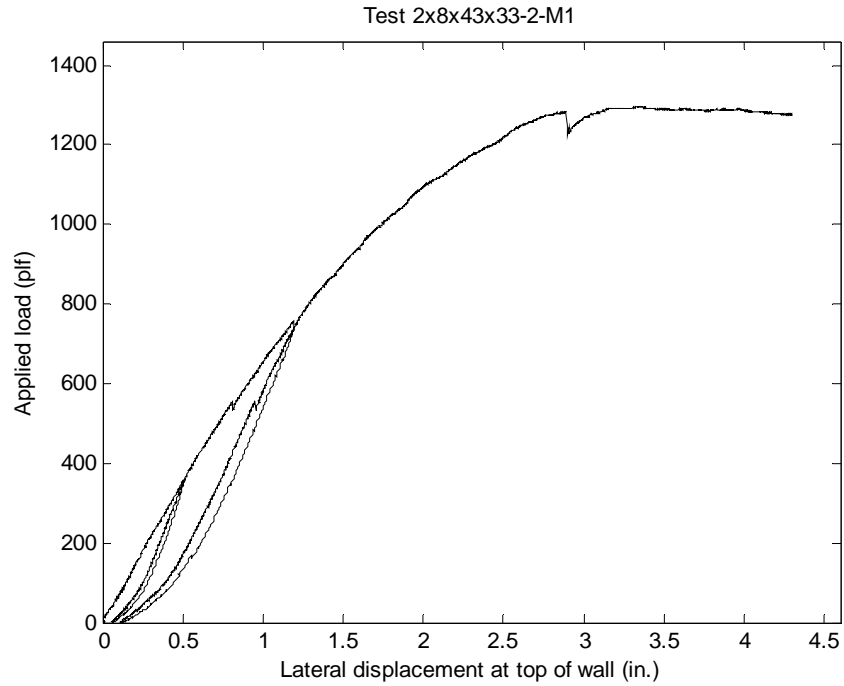

Observed Failure Mode: Steel sheet buckled; the flanges of the outer stud on the loaded side distorted in the bottom portion.



Test Label 2x8x43x33-2-M2

Test Date March 24, 2007

Specimen Configuration

Wall dimensions: 2 ft. x 8 ft. Studs: 350S162-43, 24 in. o.c. Tracks: 350T150-43 Steel sheathing: 0.033 in. thick
Fastener: #8x18-1/2" modified truss head self-drilling screw, 2 in. o.c. on the perimeter.

Test protocol: Monotonic

Test results

Maximum load: 1335 plf
Net lateral displacement at top of wall: 3.05 in.

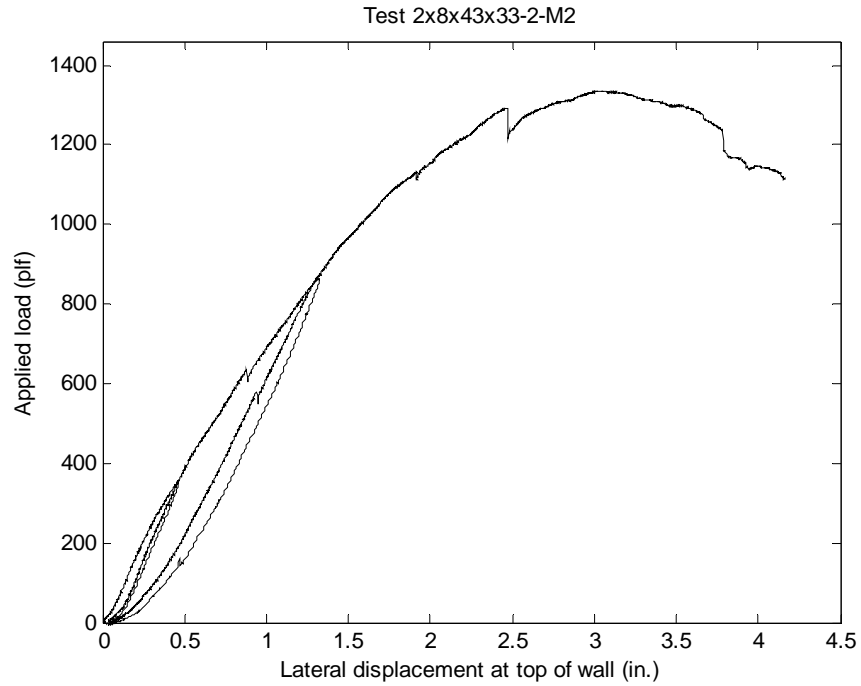

Observed Failure Mode: Steel sheet buckled; the flanges of the outer stud on the loaded side distorted in the bottom portion.



Test Label 2×8×43×30-6-M1

Test Date March 29, 2007

Specimen Configuration

Wall dimensions: 2 ft. × 8 ft. Studs: 350S162-43, 24 in. o.c. Tracks: 350T150-43 Steel sheathing: 0.030 in. thick
Fastener: #8×18-1/2" modified truss head self-drilling screw, 6 in. o.c. on the perimeter.

Test protocol: Monotonic

Test results

Maximum load: 872 plf
Net lateral displacement at top of wall: 3.30 in.

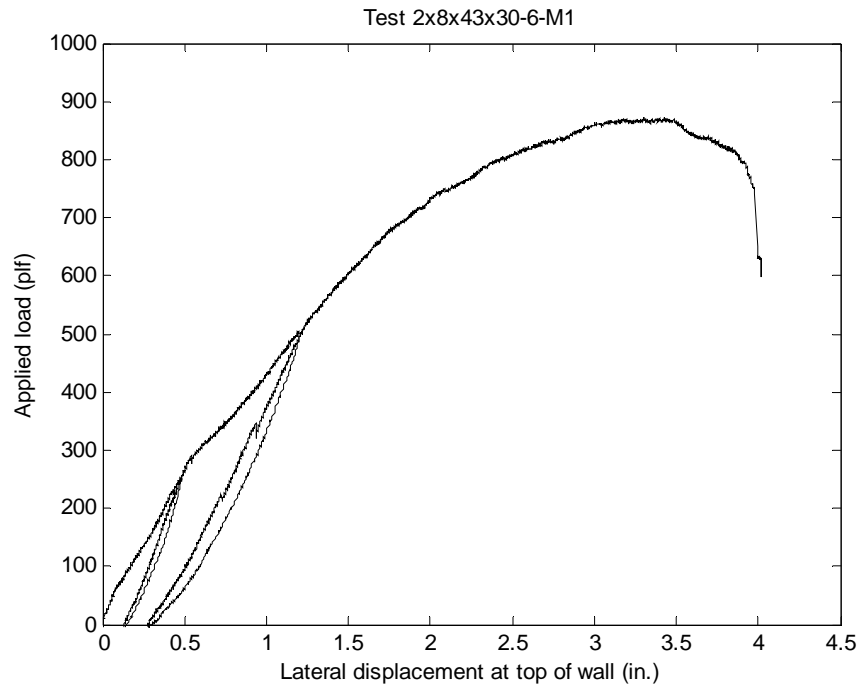

Observed Failure Mode: Steel sheet buckled and finally put off the frame at the upper unloaded corner; the unloaded chord stud distorted in the flange.



Test Label 2x8x43x30-6-M2

Test Date March 29, 2007

Specimen Configuration

Wall dimensions: 2 ft. x 8 ft. Studs: 350S162-43, 24 in. o.c. Tracks: 350T150-43 Steel sheathing: 0.030 in. thick
Fastener: #8x18-1/2" modified truss head self-drilling screw, 6 in. o.c. on the perimeter.

Test protocol: Monotonic

Test results

Maximum load: 891 plf
Net lateral displacement at top of wall: 3.40 in.

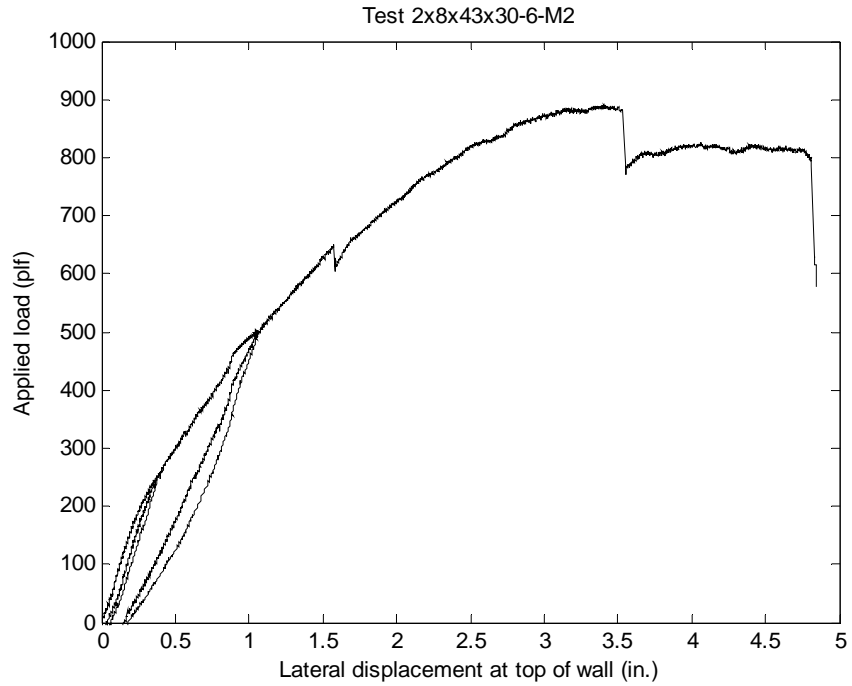

Observed Failure Mode: Steel sheet buckled and finally put off the frame at the along the loaded chord stud at the bottom.



Test Label 2x8x43x30-4-M1

Test Date March 28, 2007

Specimen Configuration

Wall dimensions: 2 ft. x 8 ft. Studs: 350S162-43, 24 in. o.c. Tracks: 350T150-43 Steel sheathing: 0.030 in. thick
Fastener: #8x18-1/2" modified truss head self-drilling screw, 4 in. o.c. on the perimeter.

Test protocol: Monotonic

Test results

Maximum load: 937 plf
Net lateral displacement at top of wall: 3.32 in.

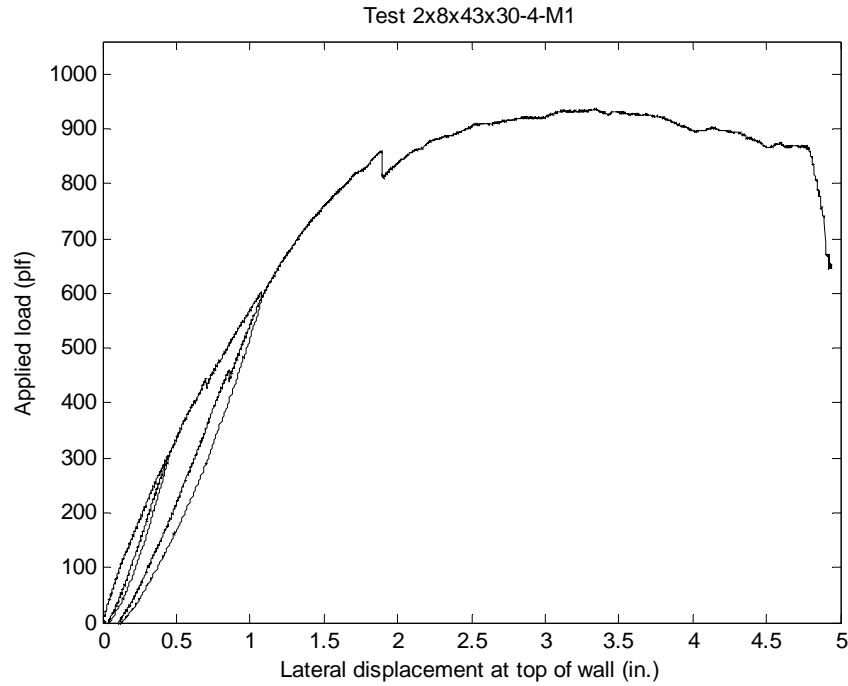

Observed Failure Mode: Steel sheet buckled and pulled off the frame at the bottom of the loaded chord stud; the loaded chord stud distorted in the outer flanges.



Test Label 2×8×43×30-4-M2

Test Date March 28, 2007

Specimen Configuration

Wall dimensions: 2 ft. × 8 ft.

Studs: 350S162-43, 24 in. o.c.

Tracks: 350T150-43

Steel sheathing: 0.030 in. thick

Fastener: #8×18-1/2" modified truss head self-drilling screw, 4 in. o.c. on the perimeter.

Test protocol: Monotonic

Test results

Maximum load: 963 plf

Net lateral displacement at top of wall: 3.25 in.

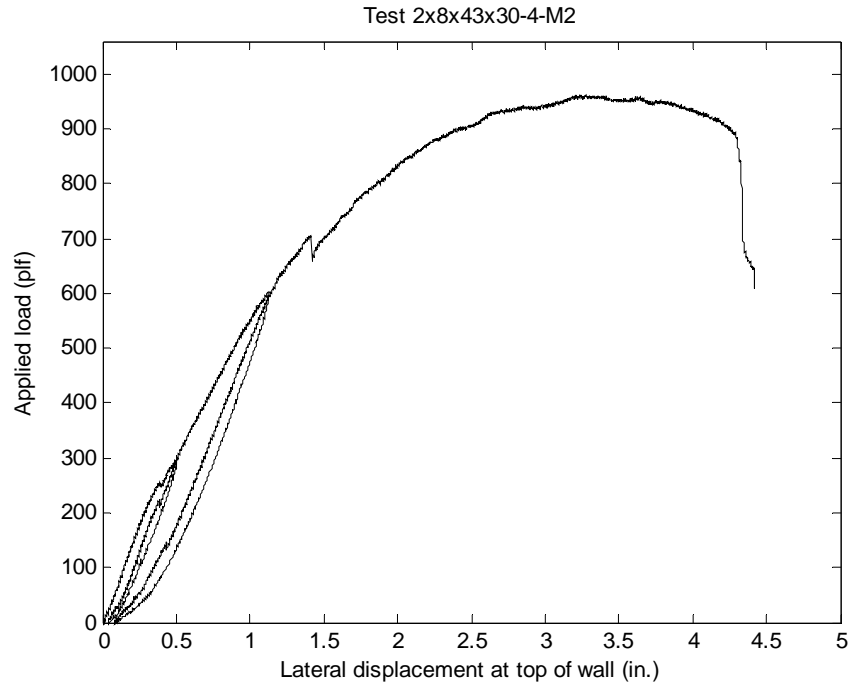

Observed Failure Mode: Steel sheet buckled and pulled off the frame at the bottom of the loaded chord stud; the loaded chord stud distorted in the outer flanges.



Test Label 2x8x43x30-2-M1

Test Date March 27, 2007

Specimen Configuration

Wall dimensions: 2 ft. x 8 ft. Studs: 350S162-43, 24 in. o.c. Tracks: 350T150-43 Steel sheathing: 0.030 in. thick
Fastener: #8x18-1/2" modified truss head self-drilling screw, 2 in. o.c. on the perimeter.

Test protocol: Monotonic

Test results

Maximum load: 1096 plf
Net lateral displacement at top of wall: 3.30 in.

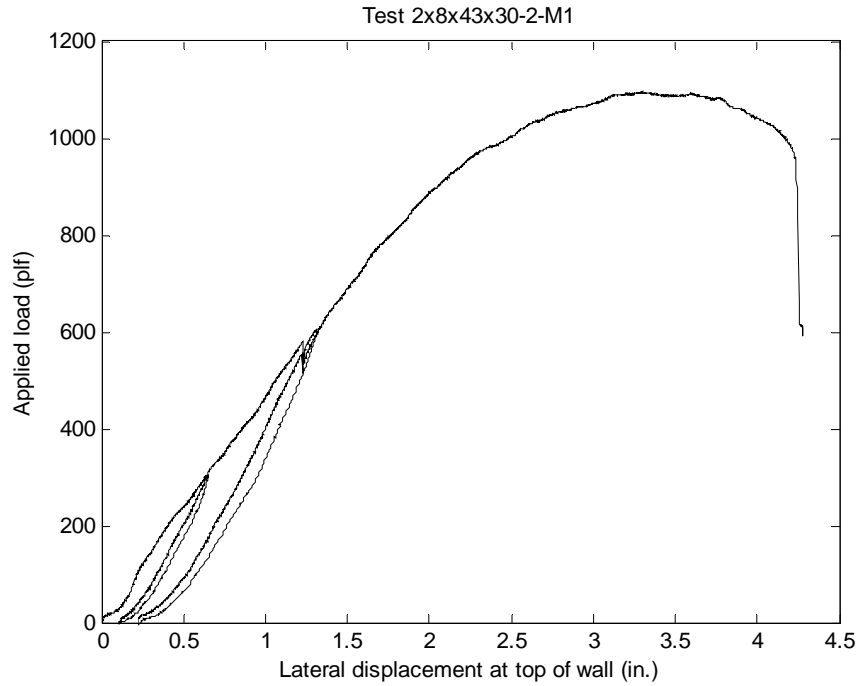

Observed Failure Mode: Steel sheet buckled; the unladed chord stud buckled in the web as well as in the flange.



Test Label 2x8x43x30-2-M2

Test Date March 27, 2007

Specimen Configuration

Wall dimensions: 2 ft. x 8 ft.

Studs: 350S162-43, 24 in. o.c.

Tracks: 350T150-43

Steel sheathing: 0.030 in. thick

Fastener: #8x18-1/2" modified truss head self-drilling screw, 2 in. o.c. on the perimeter.

Test protocol: Monotonic

Test results

Maximum load: 1098 plf

Net lateral displacement at top of wall: 3.43 in.

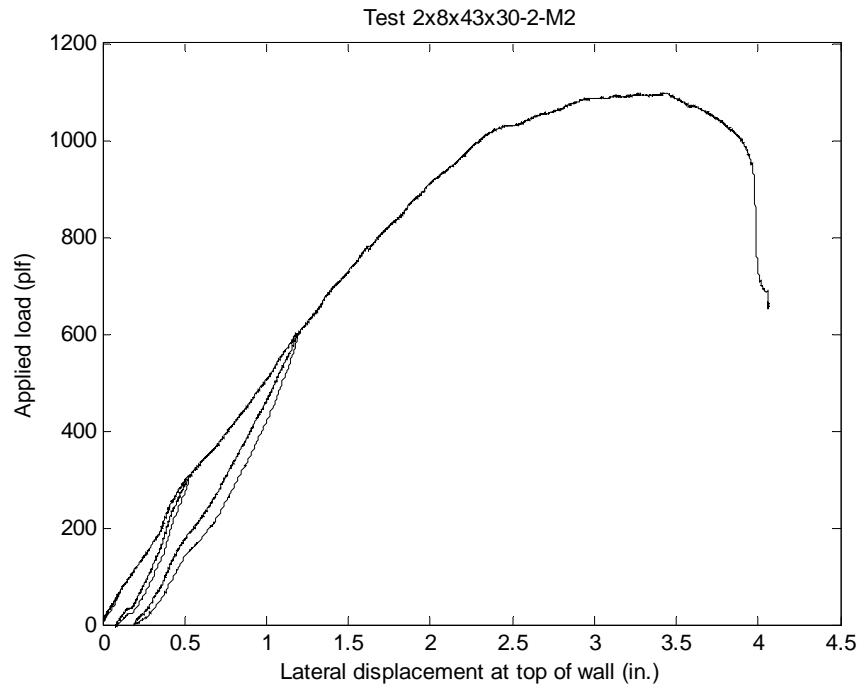

Observed Failure Mode: Steel sheet buckled; the unladed chord stud buckled in the web as well as in the flange.



APPENDIX B

DATA SHEETS OF CYCLIC TESTS (MAIN GROUP)

Test Label 4x8x43x33-6/12-C1

Test Date March 22, 2007

Specimen Configuration

Wall dimensions: 4 ft. x 8 ft. Studs: 350S162-43, 24 in. o.c. Tracks: 350T150-43 Steel sheathing: 0.033 in.
Fastener: #8x18-1/2" modified truss head self-drilling tapping screw, 6 in. o.c. on the perimeter, 12 in. o.c. in the field.

Test protocol: Cyclic CUREE

Test results

Maximum +load: 1158 plf
Net lateral displacement at top of wall at Maximum +load: 1.66 in.

Maximum -load: -1067 plf
Net lateral displacement at top of wall at Maximum -load: -1.63 in.

Average maximum load: 1113 plf
Average net displacement: 1.65 in.

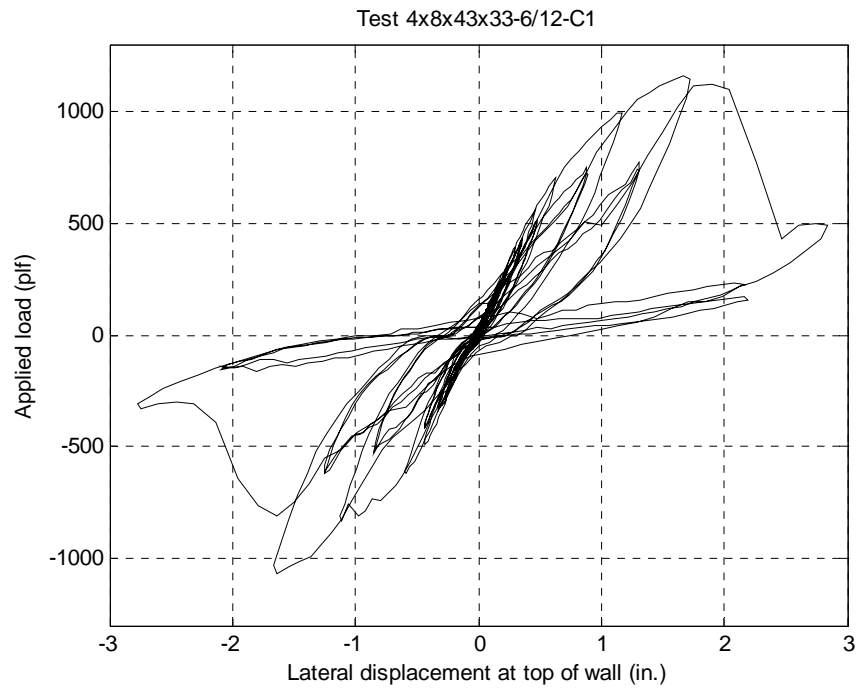

Observed Failure Mode: steel sheet buckled and pulled off the frame along the bottom track and the bottom portion of the chord studs.



Test Label 4x8x43x33-6/12-C2

Test Date March 22, 2007

Specimen Configuration

Wall dimensions: 4 ft. x 8 ft. Studs: 350S162-43, 24 in. o.c. Tracks: 350T150-43 Steel sheathing: 0.033 in.
Fastener: #8x18-1/2" modified truss head self-drilling tapping screw, 6 in. o.c. on the perimeter, 12 in. o.c. in the field.

Test protocol: Cyclic CUREE

Test results

Maximum +load: 1160 plf
Net lateral displacement at top of wall at Maximum +load: 1.63 in.

Maximum -load: -984 plf
Net lateral displacement at top of wall at Maximum -load: -1.59 in.

Average maximum load: 1072 plf
Average net displacement: 1.61 in.

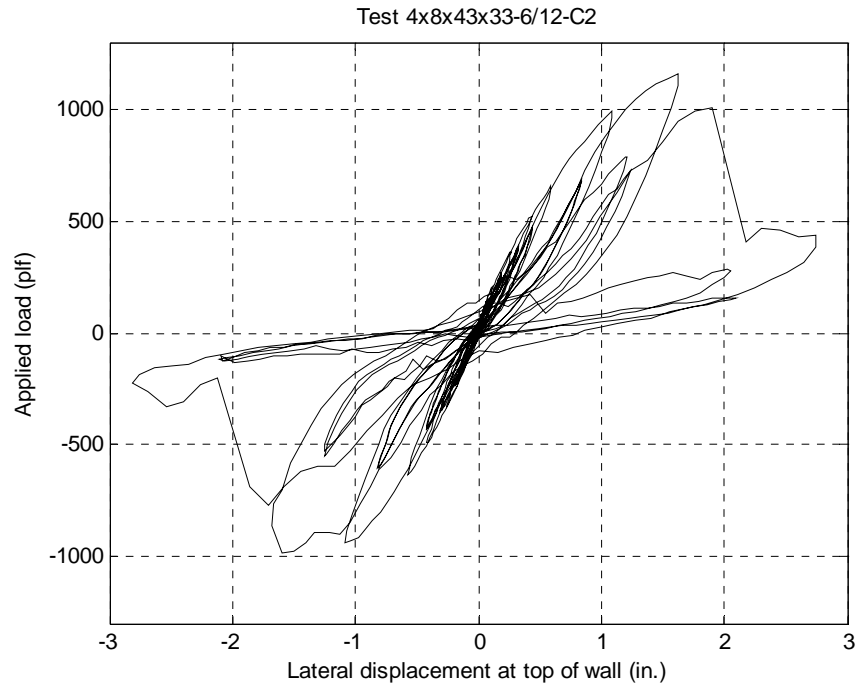

Observed Failure Mode: steel sheet buckled and pulled off the frame along the bottom track and the bottom portion of the chord studs.



Test Label 4x8x43x33-4/12-C1

Test Date March 22, 2007

Specimen Configuration

Wall dimensions: 4 ft. x 8 ft. Studs: 350S162-43, 24 in. o.c. Tracks: 350T150-43 Steel sheathing: 0.033 in.
Fastener: #8x18-1/2" modified truss head self-drilling tapping screw, 4 in. o.c. on the perimeter, 12 in. o.c. in the field.

Test protocol: Cyclic CUREE

Test results

Maximum +load: 1225 plf
Net lateral displacement at top of wall at Maximum +load: 1.69 in.

Maximum -load: -1148 plf
Net lateral displacement at top of wall at Maximum -load: -1.89 in.

Average maximum load: 1187 plf
Average net displacement: 1.79 in.

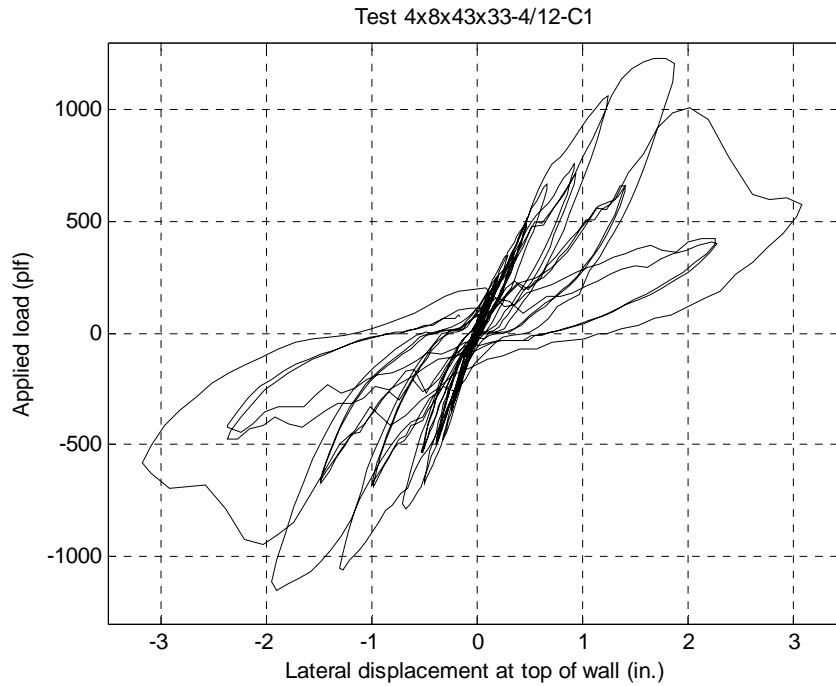

Observed Failure Mode: steel sheet buckled and finally pulled off the frame at both corners on the loaded side and at the center of the interior stud.





Test Label 4x8x43x33-4/12-C2

Test Date March 22, 2007

Specimen Configuration

Wall dimensions: 4 ft. x 8 ft. Studs: 350S162-43, 24 in. o.c. Tracks: 350T150-43 Steel sheathing: 0.033 in.
Fastener: #8x18-1/2" modified truss head self-drilling tapping screw, 4 in. o.c. on the perimeter, 12 in. o.c. in the field.

Test protocol: Cyclic CUREE

Test results

Maximum +load: 1193 plf
Net lateral displacement at top of wall at Maximum +load: 1.70 in.

Maximum -load: -1271 plf
Net lateral displacement at top of wall at Maximum -load: -1.66 in.

Average maximum load: 1232 plf
Average net displacement: 1.67 in.

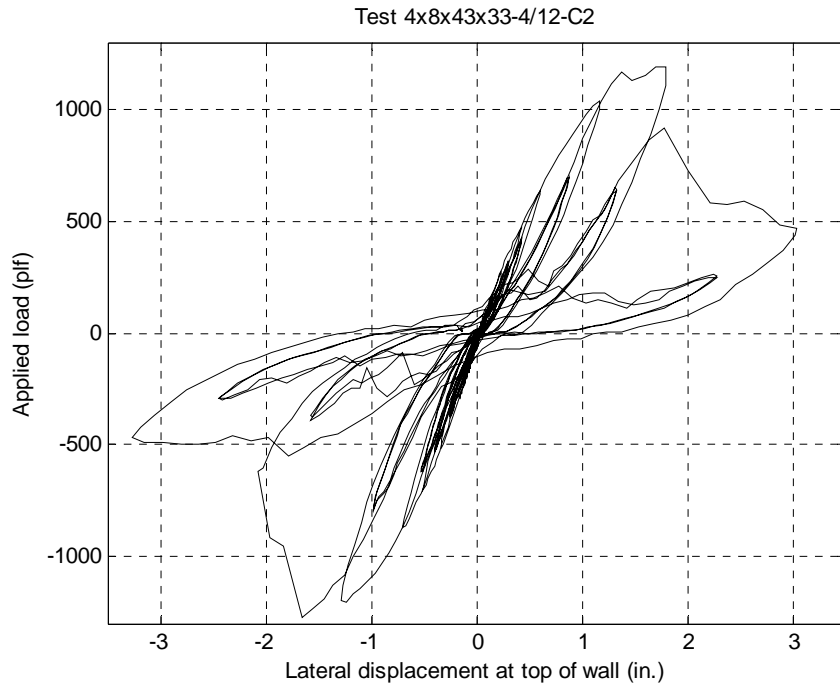

Observed Failure Mode: steel sheet buckled and finally pulled off the frame at the center of the interior stud and at the lower corner of the wall on the unloaded side.





Test Label 4x8x43x33-2/12-C1

Test Date March 23, 2007

Specimen Configuration

Wall dimensions: 4 ft. x 8 ft. Studs: 350S162-43, 24 in. o.c. Tracks: 350T150-43 Steel sheathing: 0.033 in.
Fastener: #8x18-1/2" modified truss head self-drilling tapping screw, 2 in. o.c. on the perimeter, 12 in. o.c. in the field.

Test protocol: Cyclic CUREE

Test results

Maximum +load: 1397 plf
Net lateral displacement at top of wall at Maximum +load: 1.57 in.

Maximum -load: -1401 plf
Net lateral displacement at top of wall at Maximum -load: -1.91 in.

Average maximum load: 1399 plf
Average net displacement: 1.74 in.

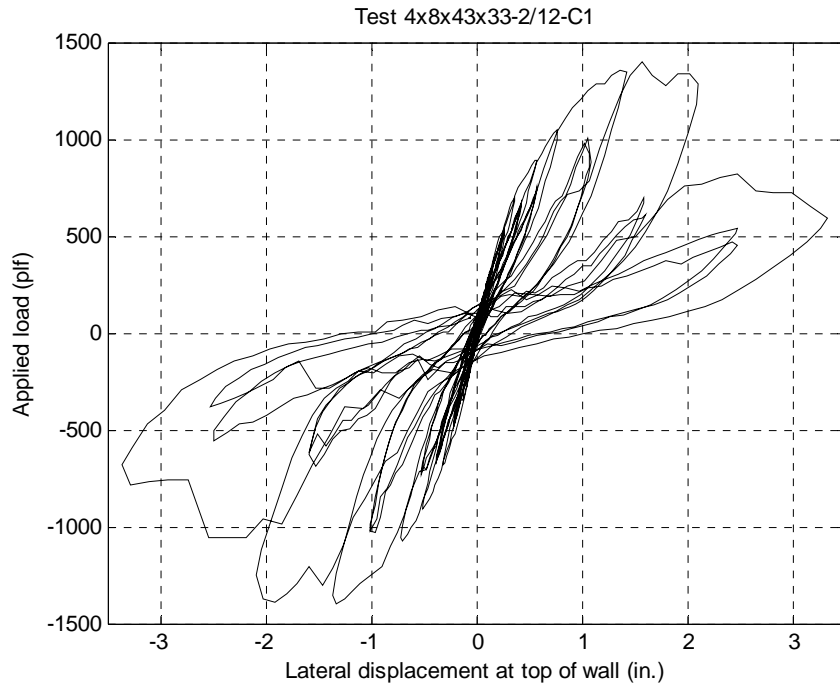

Observed Failure Mode: steel sheet buckled and finally pulled off the frame at the center of the interior stud.



Test Label 4x8x43x33-2/12-C2

Test Date March 23, 2007

Specimen Configuration

Wall dimensions: 4 ft. x 8 ft. Studs: 350S162-43, 24 in. o.c. Tracks: 350T150-43 Steel sheathing: 0.033 in.
Fastener: #8x18-1/2" modified truss head self-drilling tapping screw, 2 in. o.c. on the perimeter, 12 in. o.c. in the field.

Test protocol: Cyclic CUREE

Test results

Maximum +load: 1283 plf
Net lateral displacement at top of wall at Maximum +load: 1.52 in.

Maximum -load: -1318 plf
Net lateral displacement at top of wall at Maximum -load: -2.08 in.

Average maximum load: 1301 plf
Average net displacement: 1.80 in.

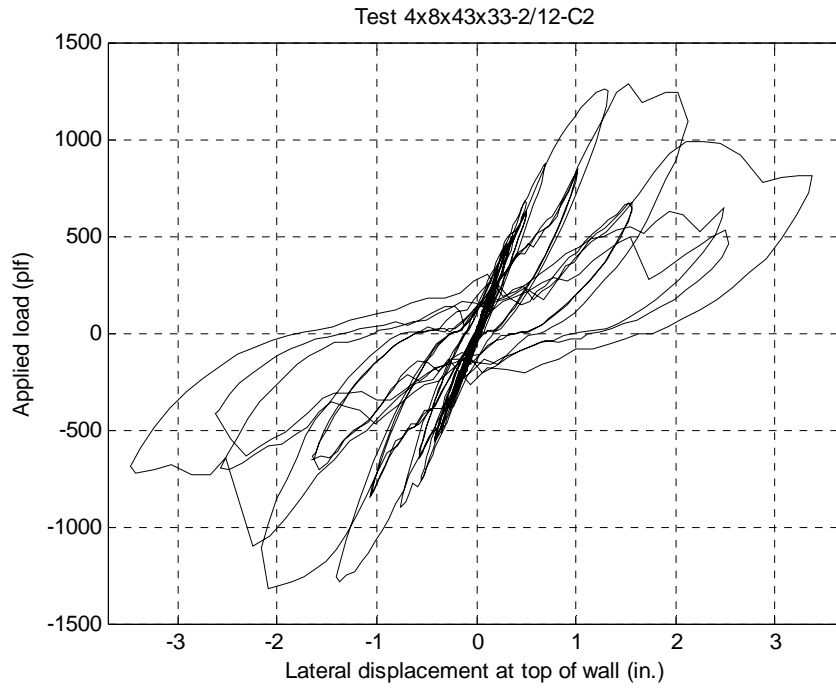

Observed Failure Mode: steel sheet buckled and finally pulled off the frame at the center of the interior stud as well as the bottom corners of the wall. Both chord studs buckled on the outer flange at the bottom area.



Test Label 4x8x43x30-6/12-C1

Test Date February 16, 2007

Specimen Configuration

Wall dimensions: 4 ft. x 8 ft. Studs: 350S162-43, 24 in. o.c. Tracks: 350T150-43 Steel sheathing: 0.030 in.
Fastener: #8x18-1/2" modified truss head self-drilling tapping screw, 6 in. o.c. on the perimeter, 12 in. o.c. in the field.

Test protocol: Cyclic CUREE

Test results

Maximum +load: 864 plf
Net lateral displacement at top of wall at Maximum +load: 1.82 in.

Maximum -load: -938 plf
Net lateral displacement at top of wall at Maximum -load: -2.01 in.

Average maximum load: 901 plf
Average net displacement: 1.92 in.

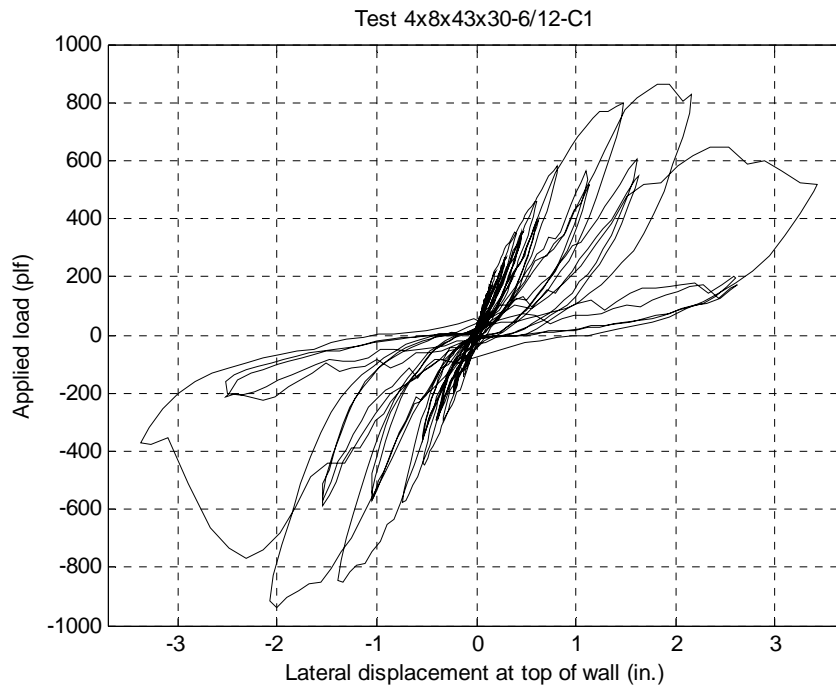

Observed Failure Mode: steel sheet buckled and finally pulled off the frame along the bottom track.

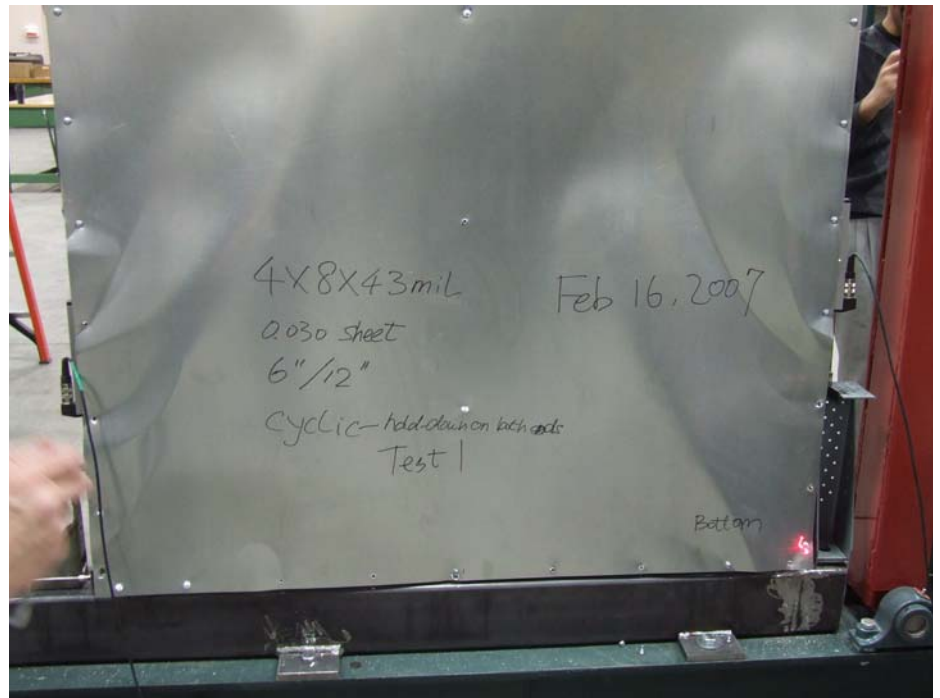

Test Label 4x8x43x30-6/12-C2

Test Date February 26, 2007

Specimen Configuration

Wall dimensions: 4 ft. x 8 ft. Studs: 350S162-43, 24 in. o.c. Tracks: 350T150-43 Steel sheathing: 0.030 in.
Fastener: #8x18-1/2" modified truss head self-drilling tapping screw, 6 in. o.c. on the perimeter, 12 in. o.c. in the field.

Test protocol: Cyclic CUREE

Test results

Maximum +load: 932 plf
Net lateral displacement at top of wall at Maximum +load: 2.52 in.

Maximum -load: -910 plf
Net lateral displacement at top of wall at Maximum -load: -1.98 in.

Average maximum load: 921 plf
Average net displacement: 2.25 in.

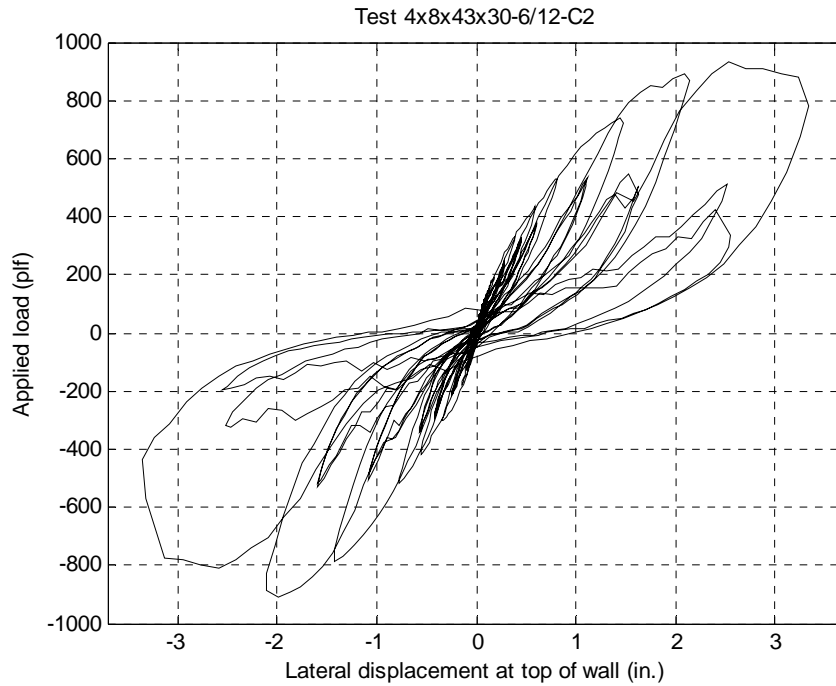

Observed Failure Mode: steel sheet buckled and finally pulled off the frame at the center of the interior stud and the lower corner of the wall at the unloaded side.





Test Label 4x8x43x30-4/12-C1

Test Date February 27, 2007

Specimen Configuration

Wall dimensions: 4 ft. x 8 ft. Studs: 350S162-43, 24 in. o.c. Tracks: 350T150-43 Steel sheathing: 0.030 in.
Fastener: #8x18-1/2" modified truss head self-drilling tapping screw, 4 in. o.c. on the perimeter, 12 in. o.c. in the field.

Test protocol: Cyclic CUREE

Test results

Maximum +load: 1008 plf
Net lateral displacement at top of wall at Maximum +load: 2.01 in.

Maximum -load: -1073 plf
Net lateral displacement at top of wall at Maximum -load: -1.94 in.

Average maximum load: 1041 plf
Average net displacement: 1.98 in.

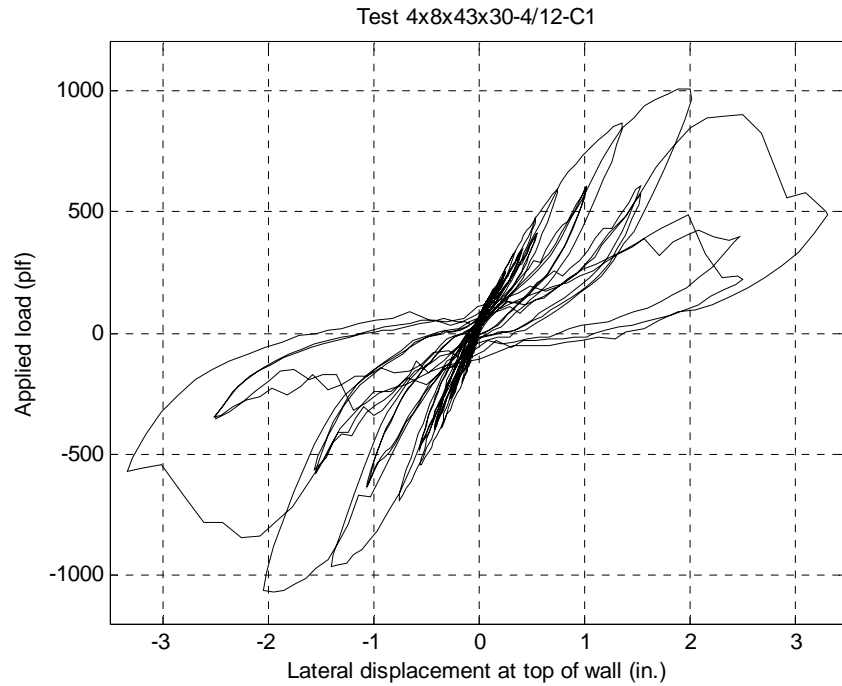

Observed Failure Mode: steel sheet buckled and finally pulled off the frame at the center of the interior stud and both lower corners of the wall.





Test Label 4×8×43×30-4/12-C2

Test Date February 27, 2007

Specimen Configuration

Wall dimensions: 4 ft. × 8 ft. Studs: 350S162-43, 24 in. o.c. Tracks: 350T150-43 Steel sheathing: 0.030 in.
Fastener: #8×18-1/2" modified truss head self-drilling tapping screw, 4 in. o.c. on the perimeter, 12 in. o.c. in the field.

Test protocol: Cyclic CUREE

Test results

Maximum +load: 925 plf
Net lateral displacement at top of wall at Maximum +load: 2.05 in.

Maximum -load: -1050 plf
Net lateral displacement at top of wall at Maximum -load: -2.01 in.

Average maximum load: 987 plf
Average net displacement: 2.03 in.

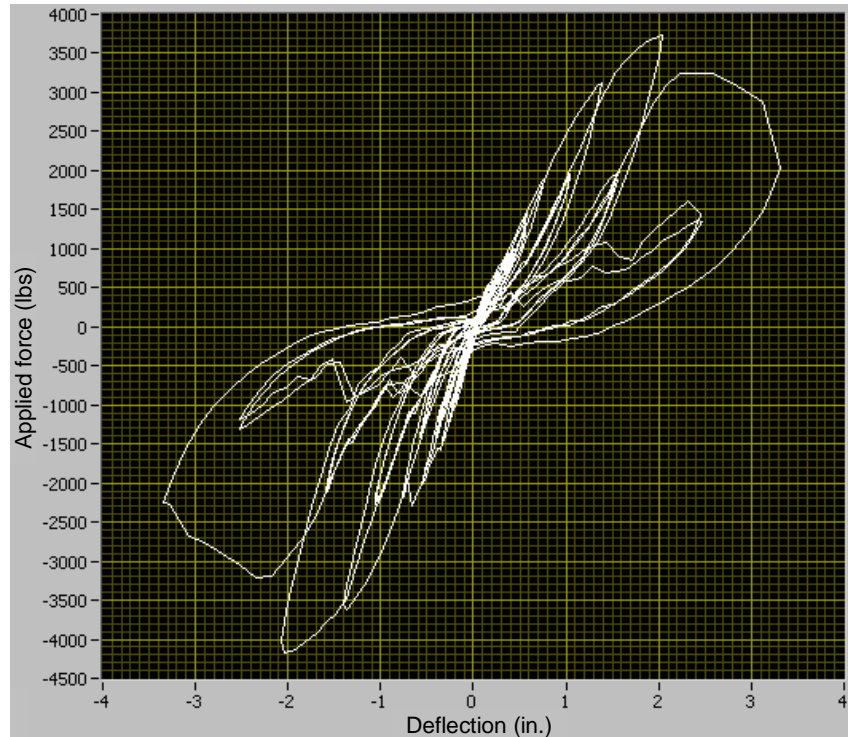

Observed Failure Mode: steel sheet buckled and finally pulled off the frame at the center of the interior stud and at both lower corners of the wall.





Test Label 4x8x43x30-2/12-C1

Test Date March 9, 2007

Specimen Configuration

Wall dimensions: 4 ft. x 8 ft. Studs: 350S162-43, 24 in. o.c. Tracks: 350T150-43 Steel sheathing: 0.030 in.
Fastener: #8x18-1/2" modified truss head self-drilling tapping screw, 2 in. o.c. on the perimeter, 12 in. o.c. in the field.

Test protocol: Cyclic CUREE

Test results

Maximum +load: 1067 plf
Net lateral displacement at top of wall at Maximum +load: 1.99 in.

Maximum -load: -1079 plf
Net lateral displacement at top of wall at Maximum -load: -1.07 in.

Average maximum load: 1073 plf
Average net displacement: 1.73 in.

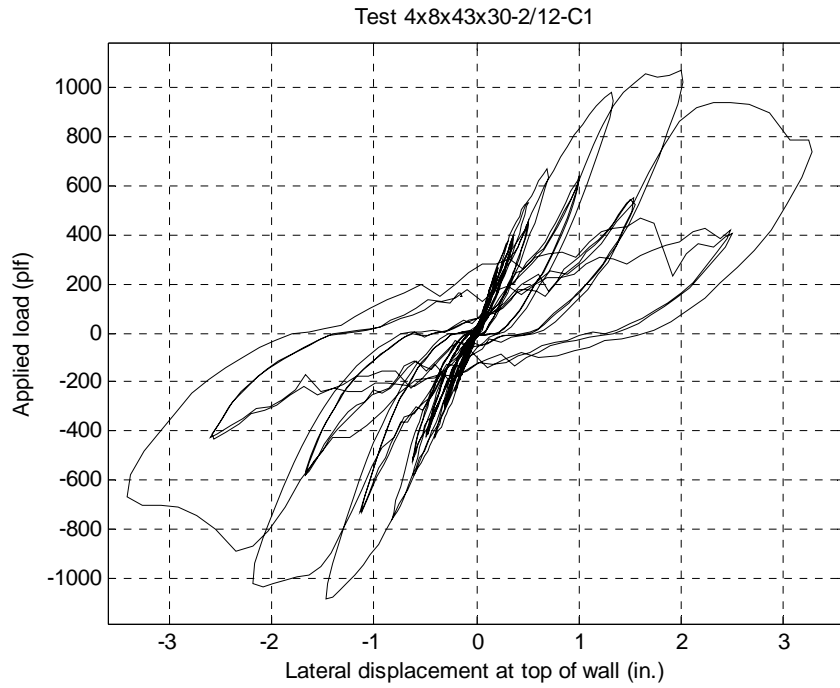

Observed Failure Mode: steel sheet buckled and finally pulled off the frame at the center of the interior stud and the lower corner of the wall at the loaded side; the loaded chord studs buckled on the flange at both top and bottom areas.





Test Label 4x8x43x30-2/12-C2

Test Date March 20, 2007

Specimen Configuration

Wall dimensions: 4 ft. x 8 ft. Studs: 350S162-43, 24 in. o.c. Tracks: 350T150-43 Steel sheathing: 0.030 in.
Fastener: #8x18-1/2" modified truss head self-drilling tapping screw, 2 in. o.c. on the perimeter, 12 in. o.c. in the field.

Test protocol: Cyclic CUREE

Test results

Maximum +load: 1048 plf
Net lateral displacement at top of wall at Maximum +load: 1.70 in.

Maximum -load: -1084 plf
Net lateral displacement at top of wall at Maximum -load: -1.84 in.

Average maximum load: 1066 plf
Average net displacement: 1.77 in.

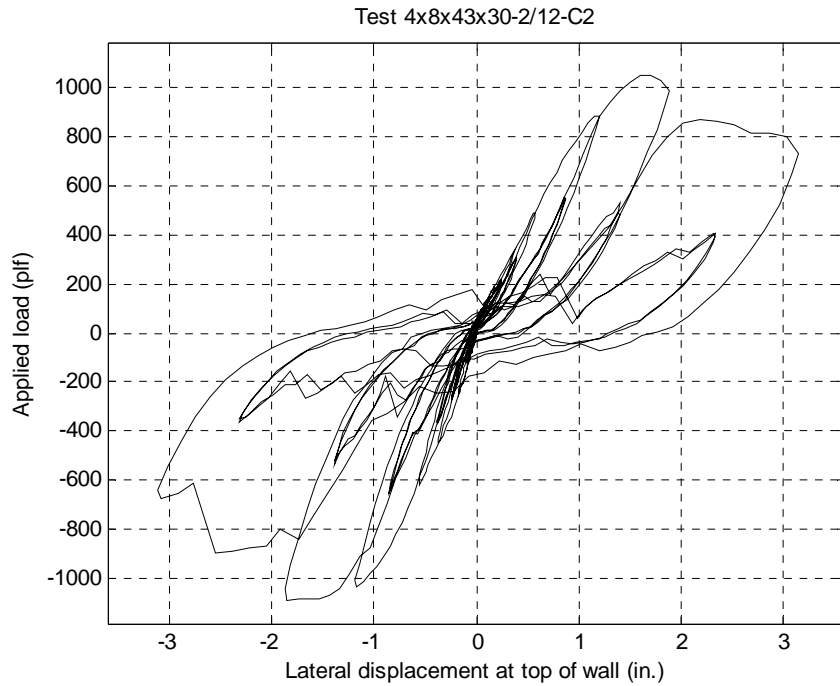

Observed Failure Mode: steel sheet buckled and finally pulled off the frame at the center of the interior stud and the lower corner of the wall at the unloaded side; both chord studs buckled on the flange at the bottom area.





Test Label 4x8x33x27-6/12-C1

Test Date March 20, 2007

Specimen Configuration

Wall dimensions: 4 ft. x 8 ft. Studs: 350S162-33, 24 in. o.c. Tracks: 350T150-33 Steel sheathing: 0.027 in.
Fastener: #8-18x1/2" modified truss head self-drilling tapping screw, 6 in. o.c. on the perimeter, 12 in. o.c. in the field.

Test protocol: Cyclic CUREE

Test results

Maximum +load: 679 plf
Net lateral displacement at top of wall at Maximum +load: 1.51 in.

Maximum -load: -628 plf
Net lateral displacement at top of wall at Maximum -load: -1.58 in.

Average maximum load: 653 plf
Average net displacement: 1.54 in.

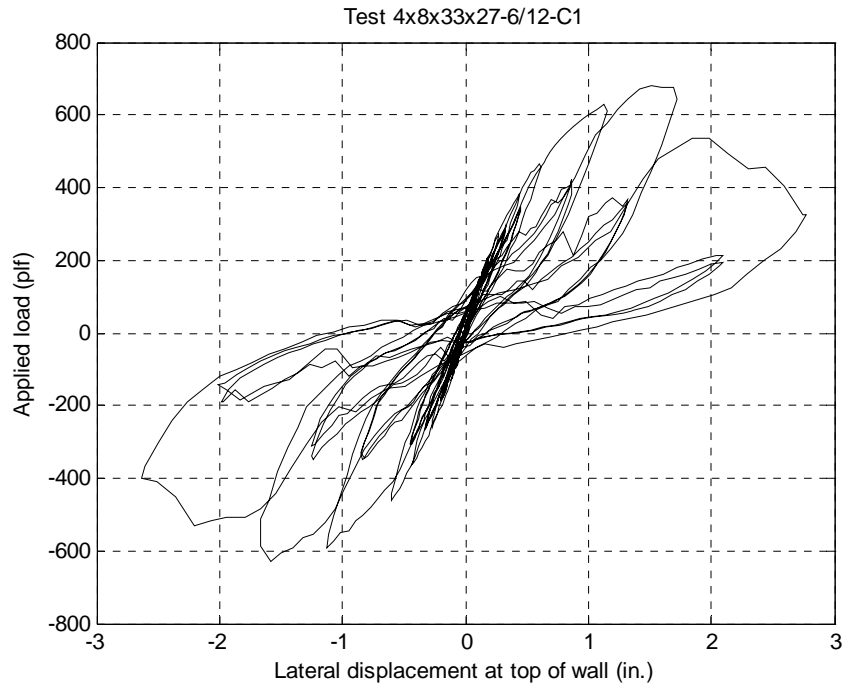

Observed Failure Mode: steel sheet buckled and finally pulled off the frame at the center of the interior stud as well as both lower corners on the chord studs.





Test Label 4x8x33x27-6/12-C2

Test Date March 20, 2007

Specimen Configuration

Wall dimensions: 4 ft. x 8 ft. Studs: 350S162-33, 24 in. o.c. Tracks: 350T150-33 Steel sheathing: 0.027 in.
Fastener: #8-18x1/2" modified truss head self-drilling tapping screw, 6 in. o.c. on the perimeter, 12 in. o.c. in the field.

Test protocol: Cyclic CUREE

Test results

Maximum +load: 622 plf
Net lateral displacement at top of wall at Maximum +load: 1.62 in.

Maximum -load: -658 plf
Net lateral displacement at top of wall at Maximum -load: -1.42 in.

Average maximum load: 640 plf
Average net displacement: 1.52 in.

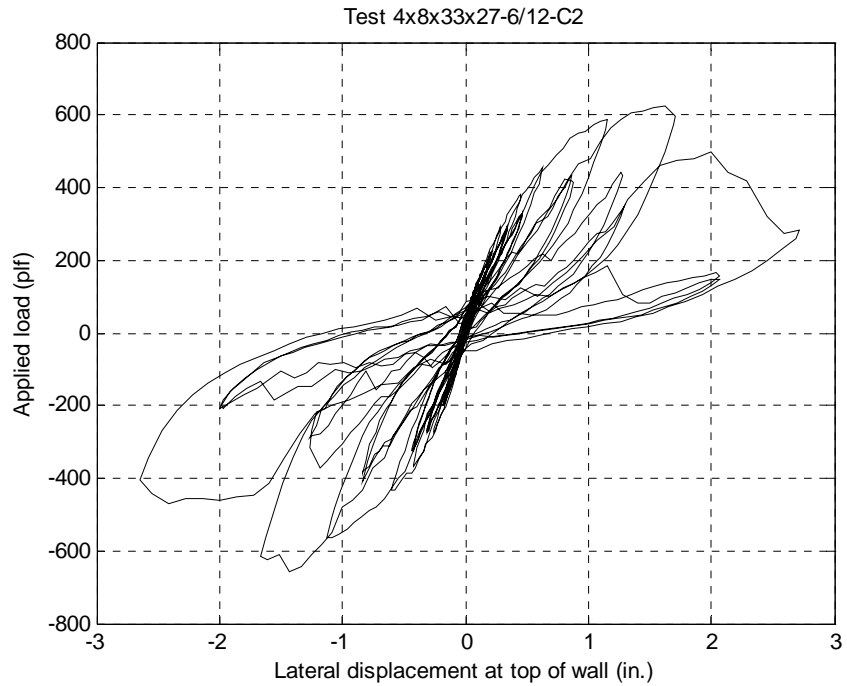

Observed Failure Mode: steel sheet buckled and finally pulled off the frame at the center of the interior stud as well as both lower corners on the chord studs.





Test Label 4x8x33x27-4/12-C1

Test Date March 21, 2007

Specimen Configuration

Wall dimensions: 4 ft. x 8 ft. Studs: 350S162-33, 24 in. o.c. Tracks: 350T150-33 Steel sheathing: 0.027 in.
Fastener: #8-18x1/2" modified truss head self-drilling tapping screw, 4 in. o.c. on the perimeter, 12 in. o.c. in the field.

Test protocol: Cyclic CUREE

Test results

Maximum +load: 708 plf
Net lateral displacement at top of wall at Maximum +load: 1.23 in.

Maximum -load: -743 plf
Net lateral displacement at top of wall at Maximum -load: -1.20 in.

Average maximum load: 726 plf
Average net displacement: 1.21 in.

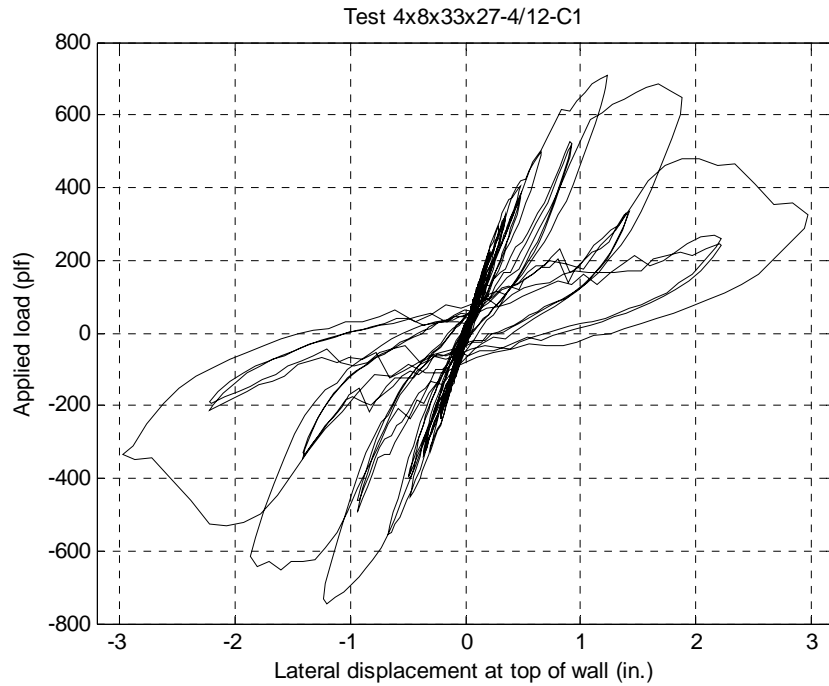

Observed Failure Mode: steel sheet buckled and finally pulled off the frame at the center of the interior stud and both lower corners on the chord studs.





Test Label 4x8x33x27-4/12-C2

Test Date March 21, 2007

Specimen Configuration

Wall dimensions: 4 ft. x 8 ft. Studs: 350S162-33, 24 in. o.c. Tracks: 350T150-33 Steel sheathing: 0.027 in.
Fastener: #8-18x1/2" modified truss head self-drilling tapping screw, 4 in. o.c. on the perimeter, 12 in. o.c. in the field.

Test protocol: Cyclic CUREE

Test results

Maximum +load: 694 plf
Net lateral displacement at top of wall at Maximum +load: 1.21 in.

Maximum -load: -694 plf
Net lateral displacement at top of wall at Maximum -load: -1.22 in.

Average maximum load: 694 plf
Average net displacement: 1.22 in.

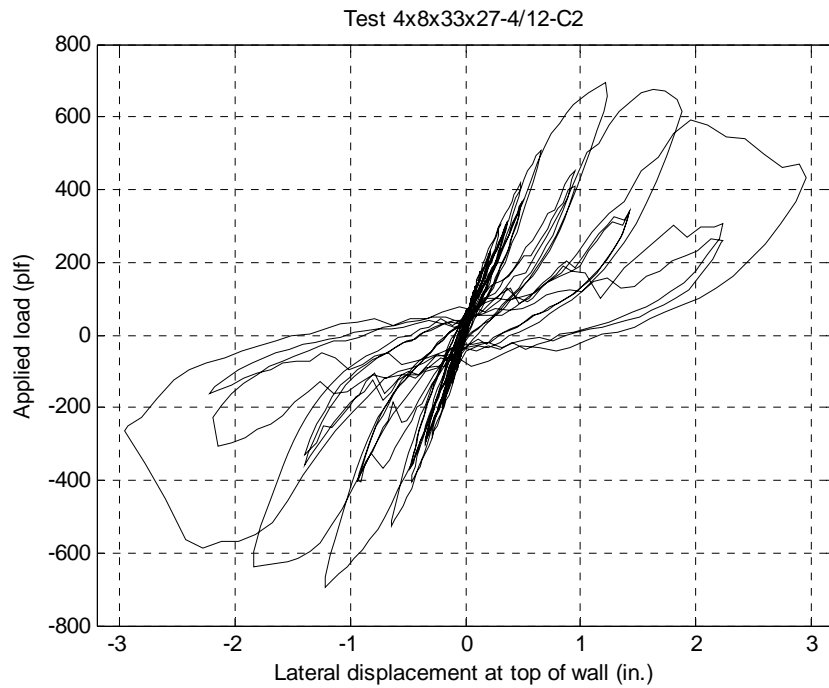

Observed Failure Mode: steel sheet buckled and finally pulled off the frame at the center of the interior stud and both lower corners on the chord studs.

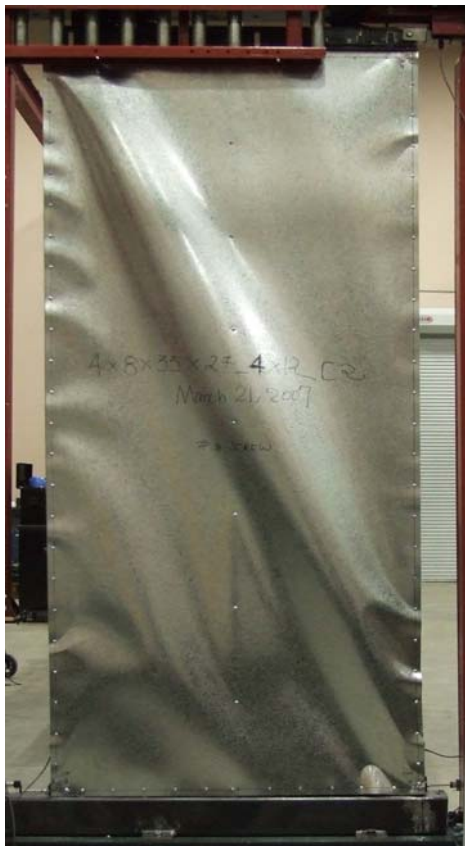



Test Label 4x8x33x27-2/12-C1

Test Date March 21, 2007

Specimen Configuration

Wall dimensions: 4 ft. x 8 ft. Studs: 350S162-33, 24 in. o.c. Tracks: 350T150-33 Steel sheathing: 0.027 in.
Fastener: #8-18x1/2" modified truss head self-drilling tapping screw, 2 in. o.c. on the perimeter, 12 in. o.c. in the field.

Test protocol: Cyclic CUREE

Test results

Maximum +load: 832 plf
Net lateral displacement at top of wall at Maximum +load: 1.73 in.

Maximum -load: -773 plf
Net lateral displacement at top of wall at Maximum -load: -1.66 in.

Average maximum load: 802 plf
Average net displacement: 1.70 in.

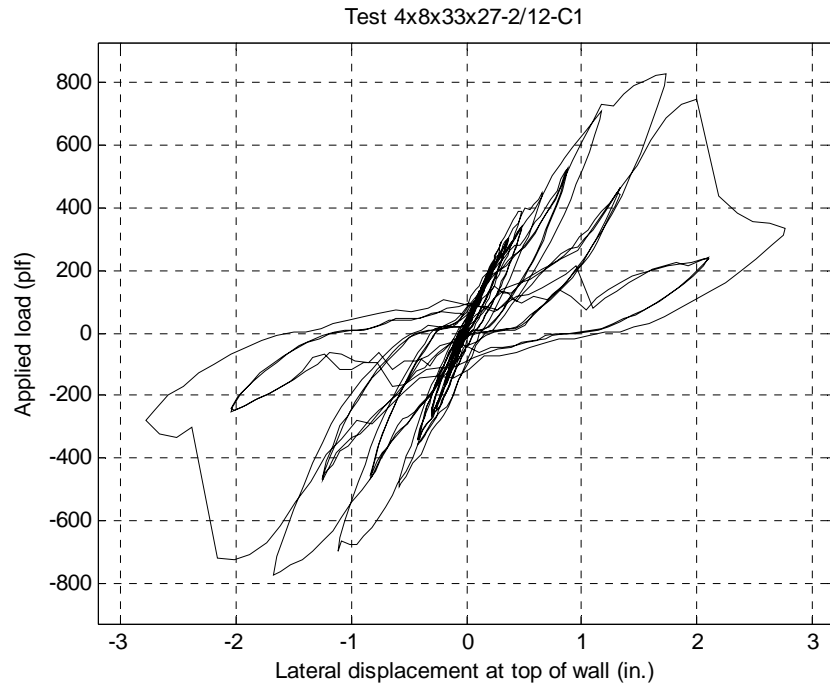

Observed Failure Mode: steel sheet buckled and finally pulled off the frame at the center of the interior stud; both chord studs buckled on the outer flange at the top portion.





Test Label 4x8x33x27-2/12-C2

Test Date March 21, 2007

Specimen Configuration

Wall dimensions: 4 ft. x 8 ft. Studs: 350S162-33, 24 in. o.c. Tracks: 350T150-33 Steel sheathing: 0.027 in.
Fastener: #8-18x1/2" modified truss head self-drilling tapping screw, 2 in. o.c. on the perimeter, 12 in. o.c. in the field.

Test protocol: Cyclic CUREE

Test results

Maximum +load: 913 plf
Net lateral displacement at top of wall at Maximum +load: 2.06 in.

Maximum -load: -861 plf
Net lateral displacement at top of wall at Maximum -load: -1.67 in.

Average maximum load: 887 plf
Average net displacement: 1.87 in.

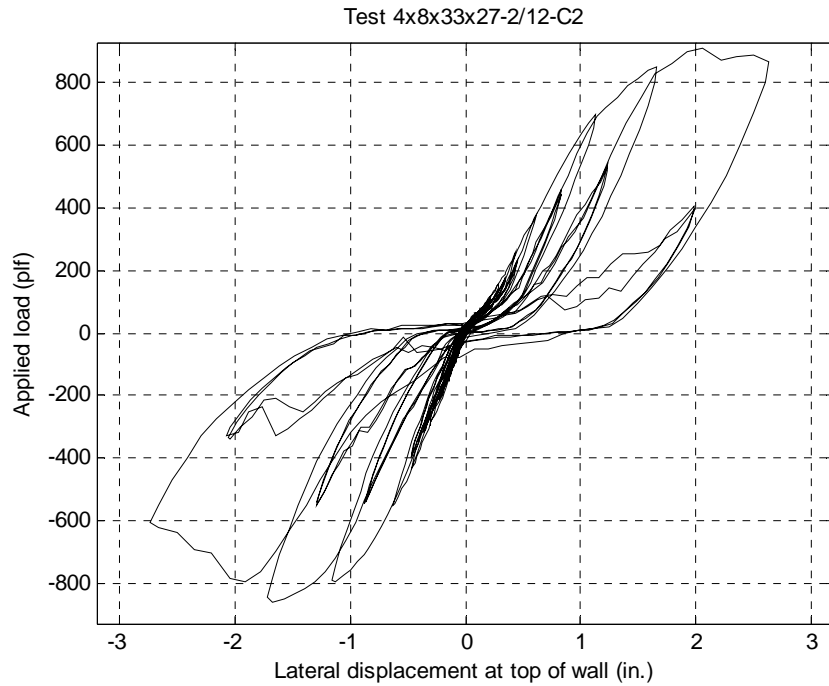

Observed Failure Mode: steel sheet buckled and finally pulled off the frame at the center of the interior stud; the flange of the outer stud on the loaded side significantly distorted, the stud on the other side showed slight distortion.





Test Label 2x8x43x33-6-C1

Test Date March 27, 2007

Specimen Configuration

Wall dimensions: 2 ft. x 8 ft. Studs: 350S162-43, 24 in. o.c. Tracks: 350T150-43 Steel sheathing: 0.033 in. thick
Fastener: #8x18-1/2" modified truss head self-drilling screw, 6 in. o.c. on the perimeter.

Test protocol: Cyclic CUREE

Test results

Maximum +load: 1104 plf
Net lateral displacement at top of wall at Maximum +load: 2.86 in.

Maximum -load: -1160 plf
Net lateral displacement at top of wall at Maximum -load: -3.10 in.

Average maximum load: 1132 plf
Average net displacement: 2.98 in.

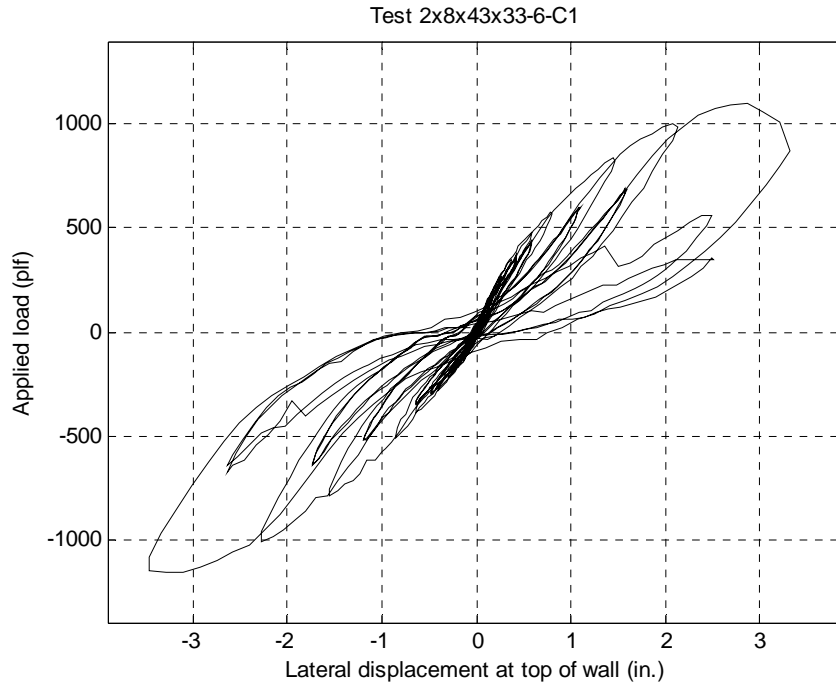

Observed Failure Mode: steel sheet buckled and pulled off the frame at the bottom of the loaded chord stud.



Test Label 2x8x43x33-6-C2

Test Date March 27, 2007

Specimen Configuration

Wall dimensions: 2 ft. x 8 ft. Studs: 350S162-43, 24 in. o.c. Tracks: 350T150-43 Steel sheathing: 0.033 in. thick
Fastener: #8x18-1/2" modified truss head self-drilling screw, 6 in. o.c. on the perimeter.

Test protocol: Cyclic CUREE

Test results

Maximum +load: 1189 plf
Net lateral displacement at top of wall at Maximum +load: 2.96 in.

Maximum -load: -1086 plf
Net lateral displacement at top of wall at Maximum -load: -3.26 in.

Average maximum load: 1137 plf
Average net displacement: 3.11 in.

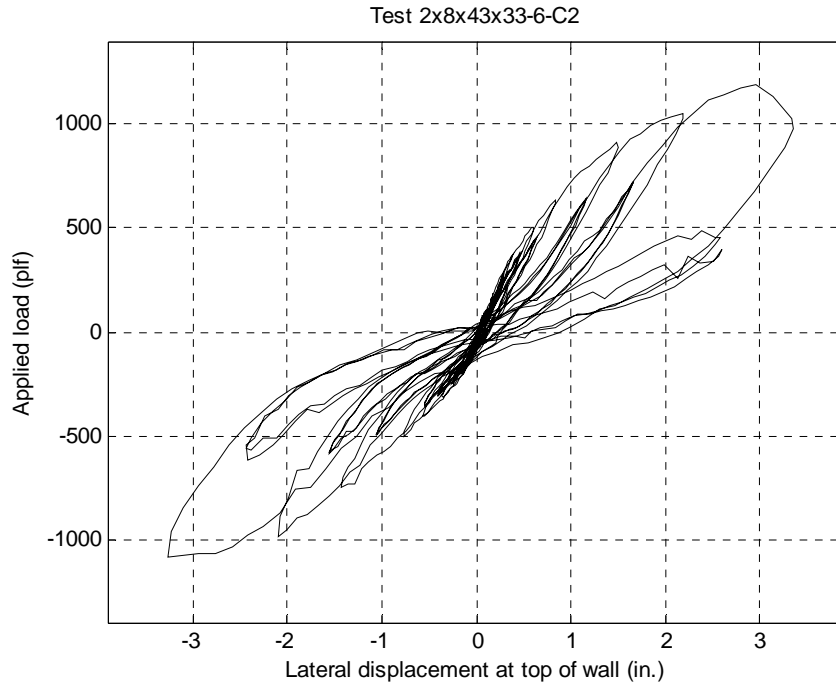

Observed Failure Mode: steel sheet buckled and pulled off the frame at the bottom of the loaded chord stud and the bottom track.



Test Label 2x8x43x33-4-C1

Test Date March 24, 2007

Specimen Configuration

Wall dimensions: 2 ft. x 8 ft. Studs: 350S162-43, 24 in. o.c. Tracks: 350T150-43 Steel sheathing: 0.033 in. thick
Fastener: #8x18-1/2" modified truss head self-drilling screw, 4 in. o.c. on the perimeter.

Test protocol: Cyclic CUREE

Test results

Maximum +load: 1257 plf
Net lateral displacement at top of wall at Maximum +load: 3.19 in.

Maximum -load: -1247 plf
Net lateral displacement at top of wall at Maximum -load: -2.84 in.

Average maximum load: 1252 plf
Average net displacement: 3.02 in.

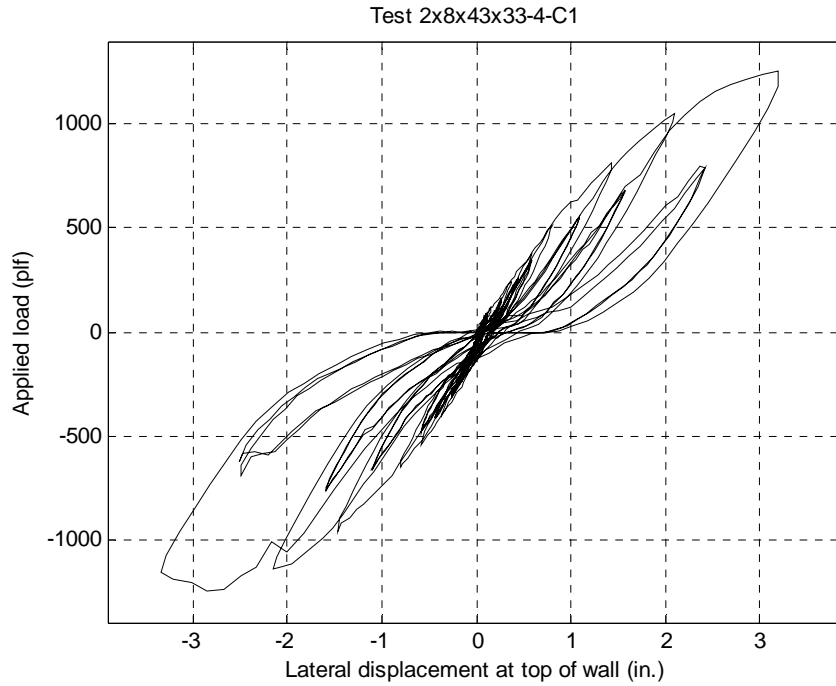

Observed Failure Mode: steel sheet buckled.



Test Label 2x8x43x33-4-C2

Test Date March 24, 2007

Specimen Configuration

Wall dimensions: 2 ft. x 8 ft.

Studs: 350S162-43, 24 in. o.c.

Tracks: 350T150-43

Steel sheathing: 0.033 in. thick

Fastener: #8x18-1/2" modified truss head self-drilling screw, 4 in. o.c. on the perimeter.

Test protocol: Cyclic CUREE

Test results

Maximum +load: 1195 plf

Net lateral displacement at top of wall at Maximum +load: 3.34 in.

Maximum -load: -1357 plf

Net lateral displacement at top of wall at Maximum -load: -3.17 in.

Average maximum load: 1276 plf

Average net displacement: 3.25 in.

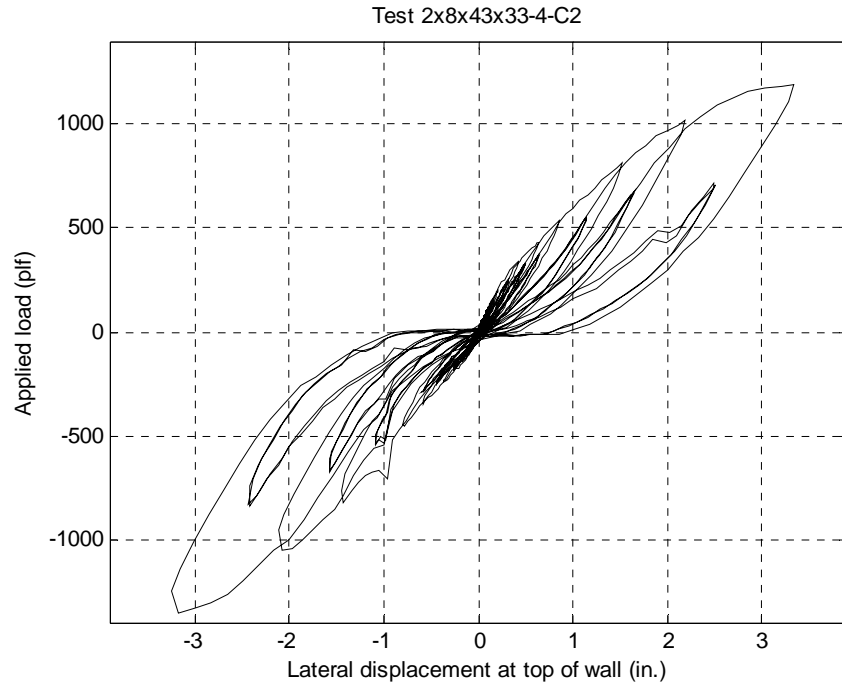

Observed Failure Mode: the steel sheet buckled.



Test Label 2x8x43x33-2-C1

Test Date March 24, 2007

Specimen Configuration

Wall dimensions: 2 ft. x 8 ft. Studs: 350S162-43, 24 in. o.c. Tracks: 350T150-43 Steel sheathing: 0.033 in. thick
Fastener: #8x18-1/2" modified truss head self-drilling screw, 2 in. o.c. on the perimeter.

Test protocol: Cyclic CUREE

Test results

Maximum +load: 1408 plf
Net lateral displacement at top of wall at Maximum +load: 3.09 in.

Maximum -load: -1450 plf
Net lateral displacement at top of wall at Maximum -load: -3.10 in.

Average maximum load: 1429 plf
Average net displacement: 3.09 in.

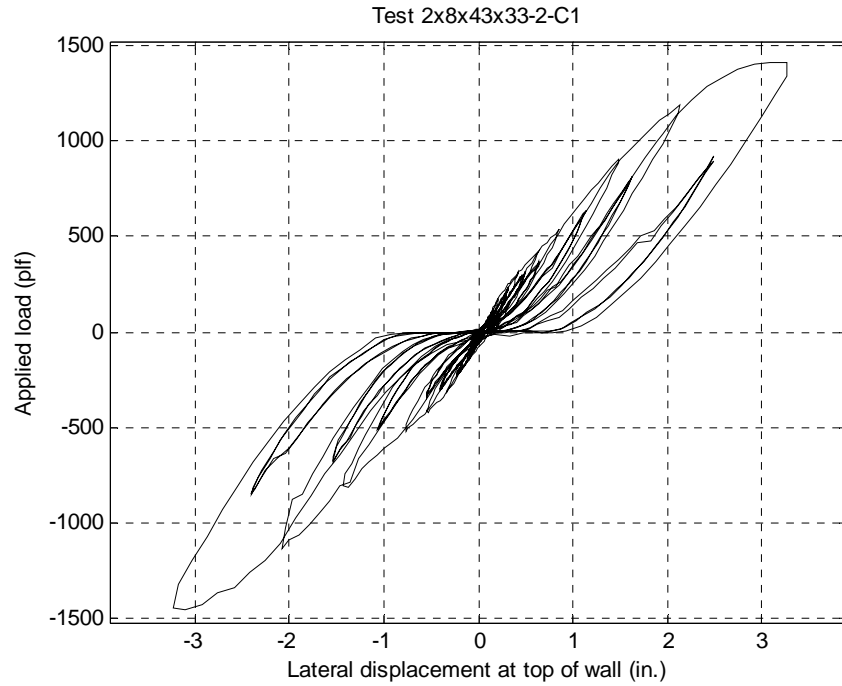

Observed Failure Mode: the steel sheet buckled.



Test Label 2x8x43x33-2-C2

Test Date March 24, 2007

Specimen Configuration

Wall dimensions: 2 ft. x 8 ft.

Studs: 350S162-43, 24 in. o.c.

Tracks: 350T150-43

Steel sheathing: 0.033 in. thick

Fastener: #8x18-1/2" modified truss head self-drilling screw, 2 in. o.c. on the perimeter.

Test protocol: Cyclic CUREE

Test results

Maximum +load: 1355 plf

Net lateral displacement at top of wall at Maximum +load: 3.19 in.

Maximum -load: -1230 plf

Net lateral displacement at top of wall at Maximum -load: -2.80 in.

Average maximum load: 1292 plf

Average net displacement: 2.99 in.

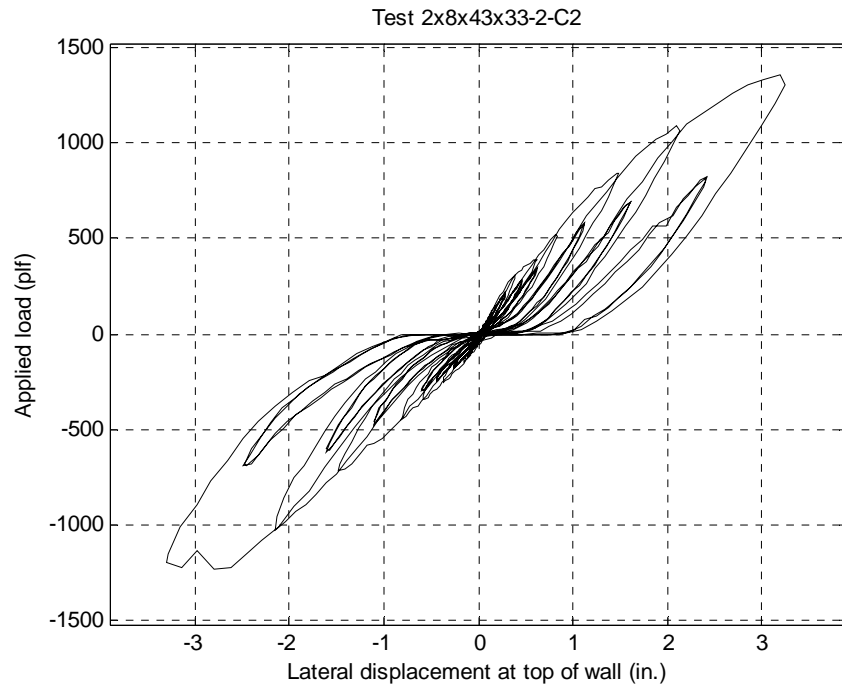

Observed Failure Mode: the steel sheet buckled.



Test Label 2x8x43x30-6-C1

Test Date March 29, 2007

Specimen Configuration

Wall dimensions: 2 ft. x 8 ft. Studs: 350S162-43, 24 in. o.c. Tracks: 350T150-43 Steel sheathing: 0.030 in. thick
Fastener: #8x18-1/2" modified truss head self-drilling screw, 6 in. o.c. on the perimeter.

Test protocol: Cyclic CUREE

Test results

Maximum +load: 942 plf
Net lateral displacement at top of wall at Maximum +load: 3.16 in.

Maximum -load: -889 plf
Net lateral displacement at top of wall at Maximum -load: -2.85 in.

Average maximum load: 916 plf
Average net displacement: 3.00 in.

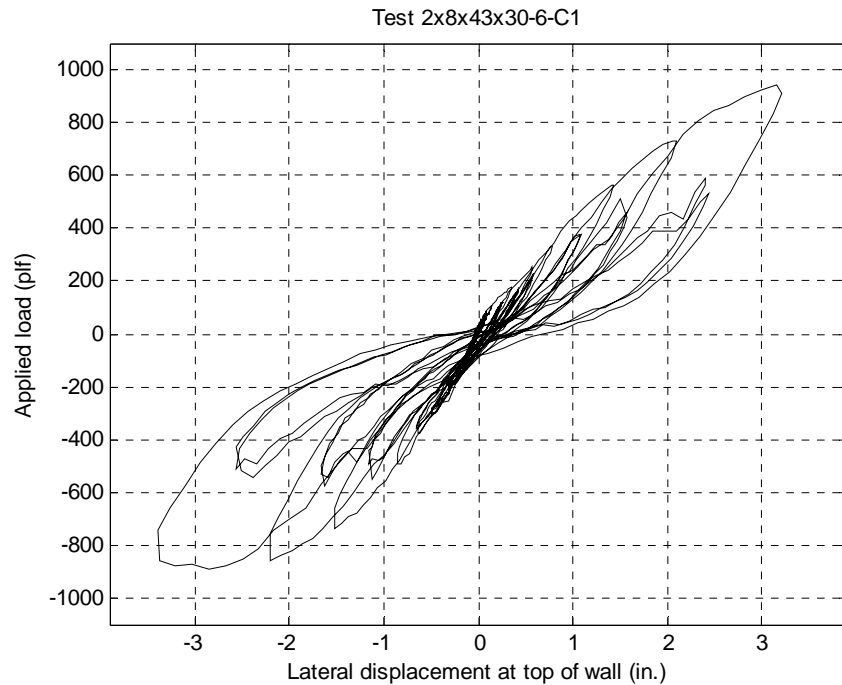

Observed Failure Mode: the steel sheet buckled; three screws at the bottom of the unloaded stud pulled out.



Test Label 2x8x43x30-6-C2

Test Date March 29, 2007

Specimen Configuration

Wall dimensions: 2 ft. x 8 ft.

Studs: 350S162-43, 24 in. o.c.

Tracks: 350T150-43

Steel sheathing: 0.030 in. thick

Fastener: #8x18-1/2" modified truss head self-drilling screw, 6 in. o.c. on the perimeter.

Test protocol: Cyclic CUREE

Test results

Maximum +load: 970 plf

Net lateral displacement at top of wall at Maximum +load: 3.34 in.

Maximum -load: -891 plf

Net lateral displacement at top of wall at Maximum -load: -3.17 in.

Average maximum load: 931 plf

Average net displacement: 3.26 in.

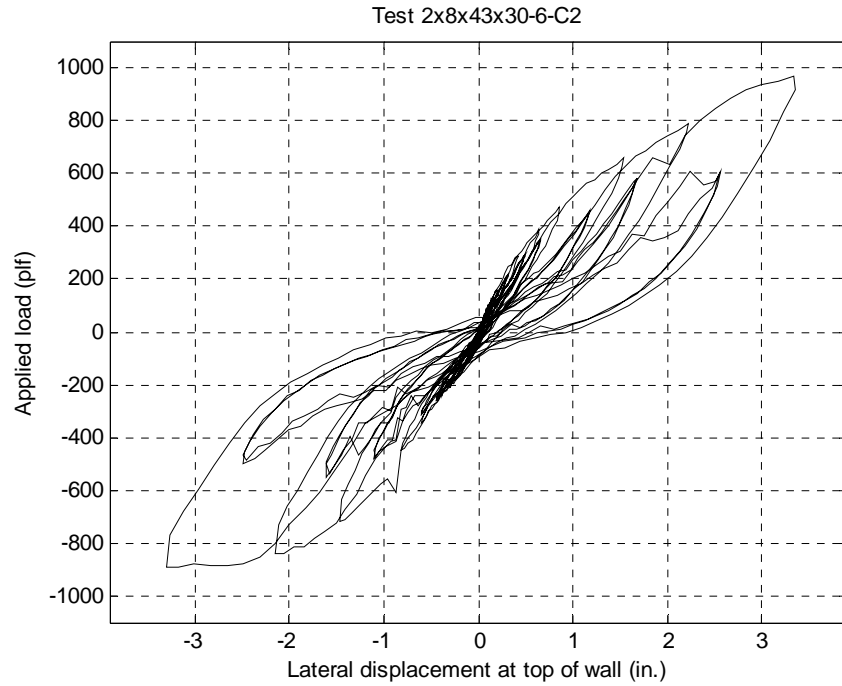

Observed Failure Mode: the steel sheet buckled; two screws at the bottom of the unloaded stud pulled out.



Test Label 2x8x43x30-4-C1

Test Date March 28, 2007

Specimen Configuration

Wall dimensions: 2 ft. x 8 ft. Studs: 350S162-43, 24 in. o.c. Tracks: 350T150-43 Steel sheathing: 0.030 in. thick
Fastener: #8x18-1/2" modified truss head self-drilling screw, 4 in. o.c. on the perimeter.

Test protocol: Cyclic CUREE

Test results

Maximum +load: 1046 plf
Net lateral displacement at top of wall at Maximum +load: 3.31 in.

Maximum -load: -1065 plf
Net lateral displacement at top of wall at Maximum -load: -3.12 in.

Average maximum load: 1055 plf
Average net displacement: 3.22 in.

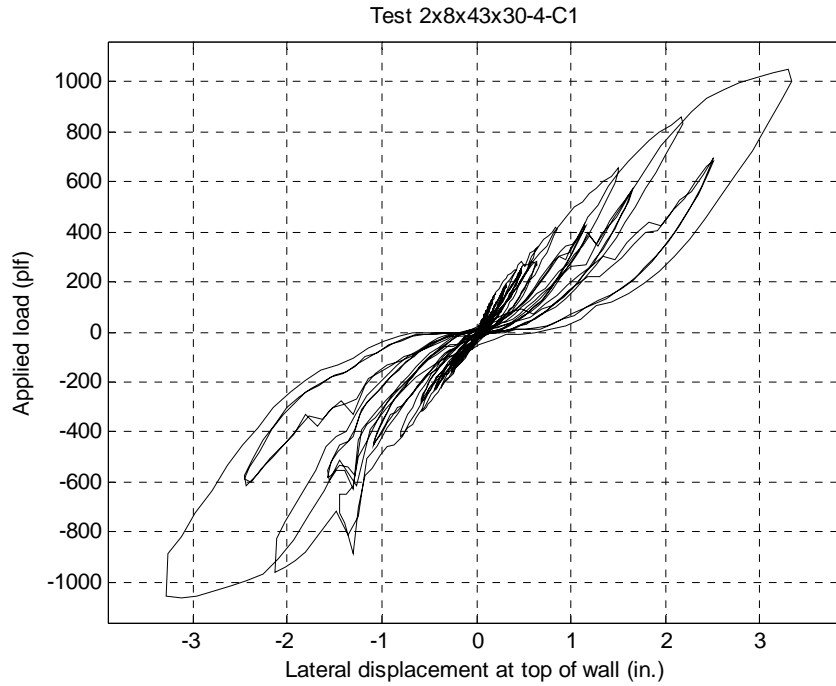

Observed Failure Mode: the steel sheet buckled.



Test Label 2x8x43x30-4-C2

Test Date March 28, 2007

Specimen Configuration

Wall dimensions: 2 ft. x 8 ft.

Studs: 350S162-43, 24 in. o.c.

Tracks: 350T150-43

Steel sheathing: 0.030 in. thick

Fastener: #8x18-1/2" modified truss head self-drilling screw, 4 in. o.c. on the perimeter.

Test protocol: Cyclic CUREE

Test results

Maximum +load: 1119 plf

Net lateral displacement at top of wall at Maximum +load: 3.18 in.

Maximum -load: -983 plf

Net lateral displacement at top of wall at Maximum -load: -2.99 in.

Average maximum load: 1051 plf

Average net displacement: 3.09 in.

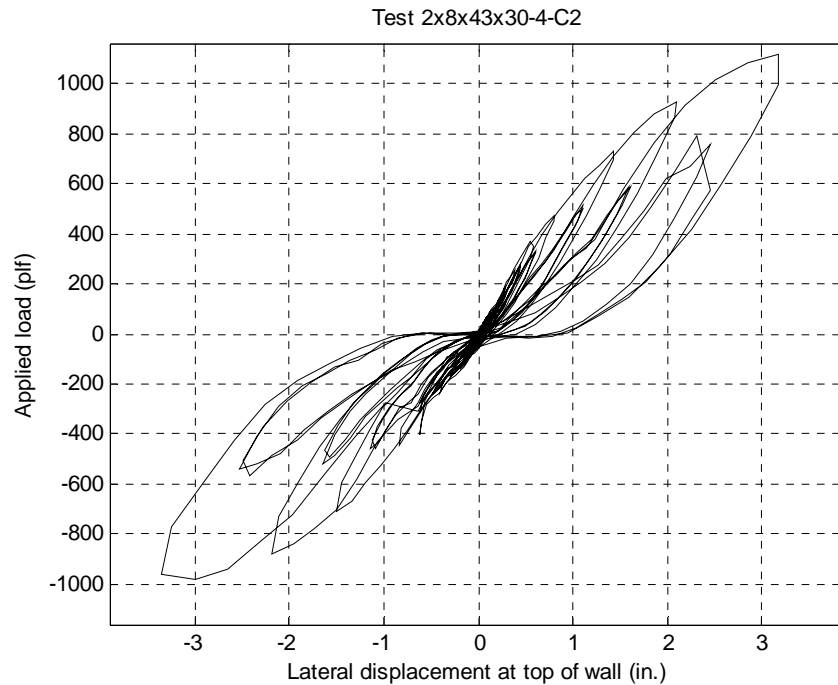

Observed Failure Mode: the steel sheet buckled.



Test Label 2x8x43x30-2-C1

Test Date March 27, 2007

Specimen Configuration

Wall dimensions: 2 ft. x 8 ft. Studs: 350S162-43, 24 in. o.c. Tracks: 350T150-43 Steel sheathing: 0.030 in. thick
Fastener: #8x18-1/2" modified truss head self-drilling screw, 2 in. o.c. on the perimeter.

Test protocol: Cyclic CUREE

Test results

Maximum +load: 1195 plf
Net lateral displacement at top of wall at Maximum +load: 3.33 in.

Maximum -load: -1200 plf
Net lateral displacement at top of wall at Maximum -load: -2.84 in.

Average maximum load: 1198 plf
Average net displacement: 3.09 in.

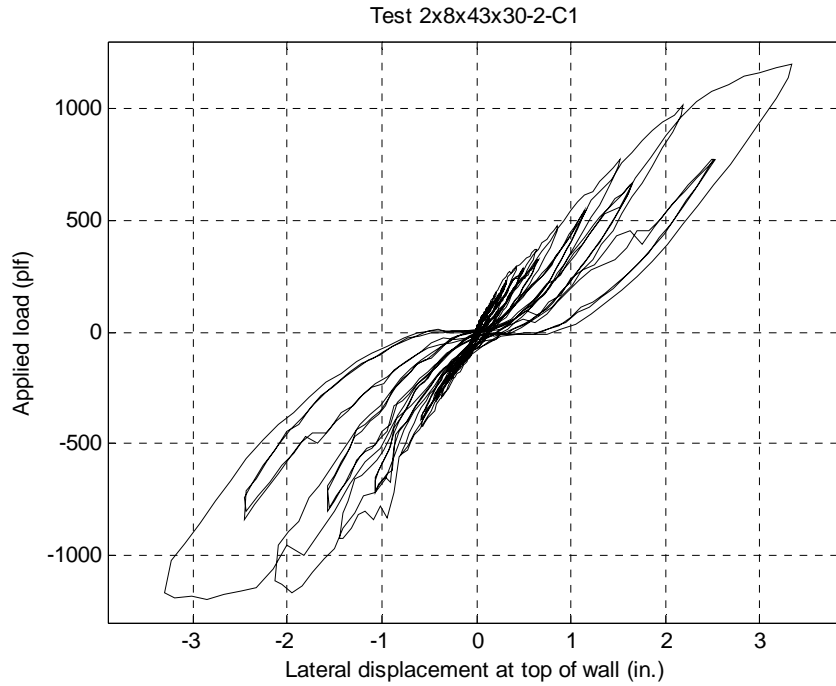

Observed Failure Mode: the steel sheet buckled.



Test Label 2x8x43x30-2-C2

Test Date March 27, 2007

Specimen Configuration

Wall dimensions: 2 ft. x 8 ft. Studs: 350S162-43, 24 in. o.c. Tracks: 350T150-43 Steel sheathing: 0.030 in. thick
Fastener: #8x18-1/2" modified truss head self-drilling screw, 2 in. o.c. on the perimeter.

Test protocol: Cyclic CUREE

Test results

Maximum +load: 1171 plf
Net lateral displacement at top of wall at Maximum +load: 3.07 in.

Maximum -load: -1246 plf
Net lateral displacement at top of wall at Maximum -load: -2.85 in.

Average maximum load: 1208 plf
Average net displacement: 2.96 in.

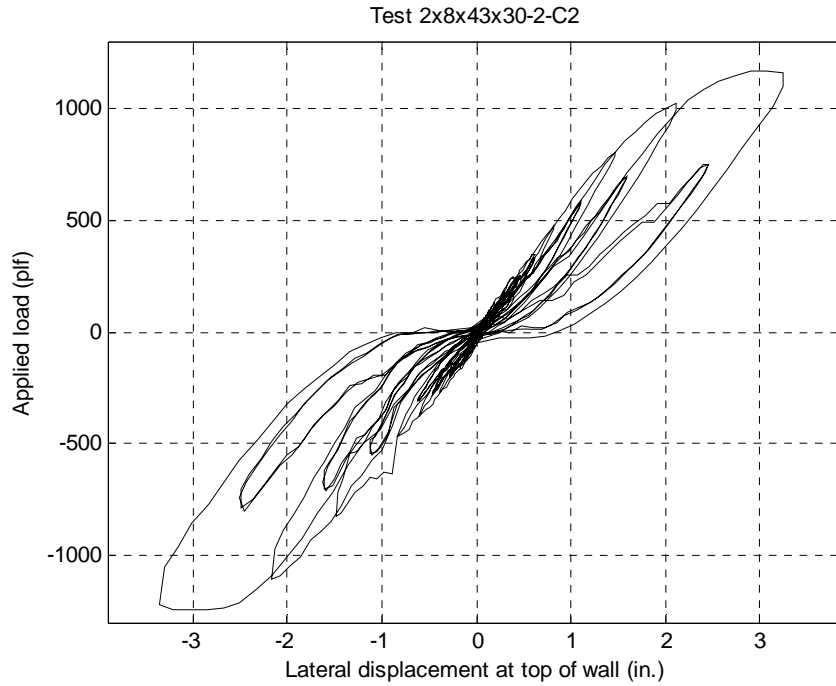

Observed Failure Mode: the steel sheet buckled.



APPENDIX C

DATA SHEETS OF ADDITIONAL TESTS (SUPPORTING GROUP)

Test Label A-1

Test Date February 20, 2007

Specimen Configuration

Wall dimensions: 4 ft. × 8 ft. Studs: 350S162-43, 24 in. o.c. Tracks: 350T150-43 Steel sheathing: 0.030 in.
Fastener: #10×18-1" modified truss head self-drilling tapping screw, 6 in. o.c. on the perimeter, 12 in. o.c. in the field.

Test protocol: Cyclic CUREE

Test results

Maximum +load: 898 plf
Net lateral displacement at top of wall at Maximum +load: 2.03 in.

Maximum -load: -868 plf
Net lateral displacement at top of wall at Maximum -load: -1.99 in.

Average maximum load: 883 plf
Average net displacement: 1.52 in.

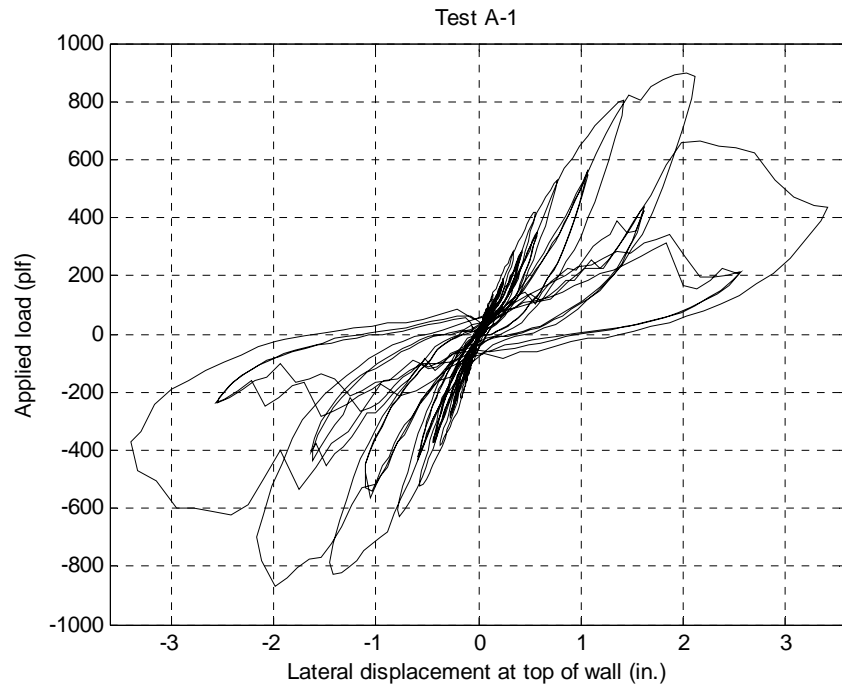

Observed Failure Mode: the steel sheet buckled and pulled off the frame at the center of the interior stud and at both bottom corners.





Test Label A-2

Test Date March 2, 2007

Specimen Configuration

Wall dimensions: 4 ft. 3 1/4 in. × 8 ft. Studs: 350S162-43, 24 in. o.c. Tracks: 350T150-43 Steel sheathing: 0.030 in.
Fastener: #8×18-1/2" modified truss head self-drilling screw, 2 in. o.c. on the perimeter, 12 in. o.c. in the field. Screws on inner flange.

Test protocol: Monotonic

Test results

Maximum load: 1091 plf
Net lateral displacement at top of wall: 2.41 in.

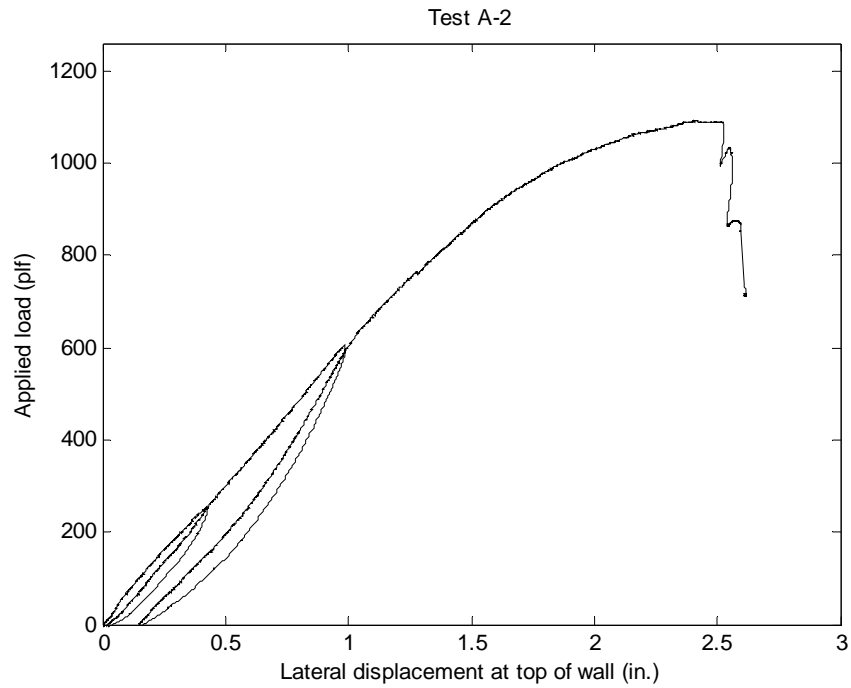

Observed Failure Mode: Steel sheet buckled and finally pulled off the frame at the center of the interior stud.



Test Label A-3

Test Date March 9, 2007

Specimen Configuration

Wall dimensions: 4 ft. 3 1/4 in × 8 ft. Studs: 350S162-43, 24 in. o.c. Tracks: 350T150-43 Steel sheathing: 0.030 in.
Fastener: #8×18-1/2" modified truss head self-drilling tapping screw, 2 in. o.c. on the perimeter, 12 in. o.c. in the field. Screws on inner flange.

Test protocol: Cyclic CUREE

Test results

Maximum +load: 1179 plf
Net lateral displacement at top of wall at Maximum +load: 1.60 in.

Maximum -load: -1137 plf
Net lateral displacement at top of wall at Maximum -load: -1.33 in.

Average maximum load: 1158 plf
Average net displacement: 1.47 in.

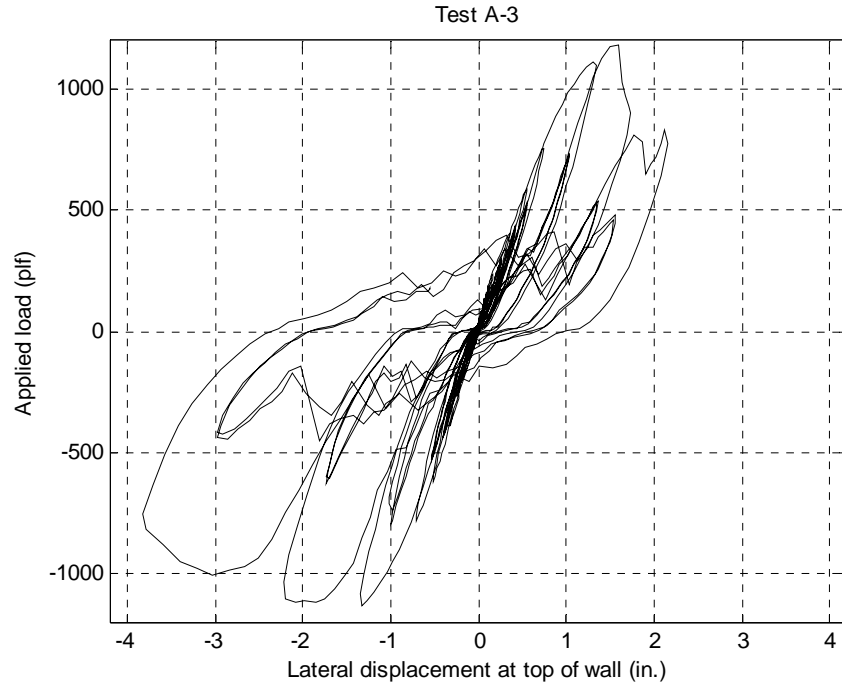

Observed Failure Mode: the steel sheet buckled and pulled off the frame at the center of the interior stud.



Test Label A-4

Test Date March 2, 2007

Specimen Configuration

Wall dimensions: 4 ft. 3 1/4 in. × 8 ft. Studs: 350S162-43, 24 in. o.c. Tracks: 350T150-43 Steel sheathing: 0.030 in.
Fastener: #8×18-1/2" modified truss head self-drilling screw, 2 in. o.c. on the perimeter, 12 in. o.c. in the field. Screws staggered on end studs.

Test protocol: Monotonic

Test results

Maximum load: 1151 plf
Net lateral displacement at top of wall: 2.60 in.

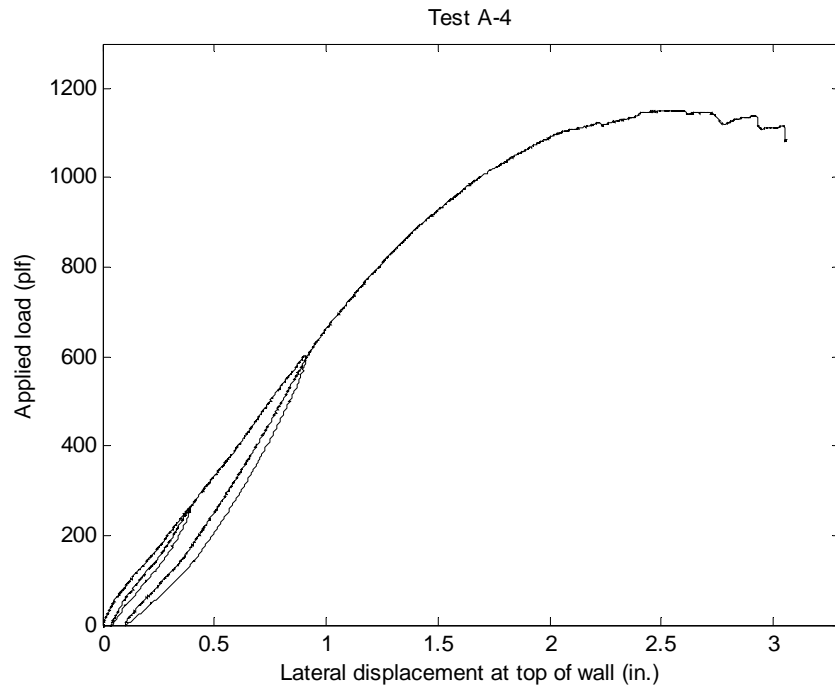

Observed Failure Mode: Steel sheet buckled; the outer flange of the loaded double stud distorted at the bottom.



Test Label A-5

Test Date March 9, 2007

Specimen Configuration

Wall dimensions: 4 ft. × 8 ft. Studs: 350S162-43, 24 in. o.c. Tracks: 350T150-43 Steel sheathing: 0.030 in.
Fastener: #8×18-1/2" modified truss head self-drilling tapping screw, 2 in. o.c. on the perimeter, 12 in. o.c. in the field. Screws staggered on end studs.

Test protocol: Cyclic CUREE

Test results

Maximum +load: 1164 plf
Net lateral displacement at top of wall at Maximum +load: 1.94 in.

Maximum -load: -1133 plf
Net lateral displacement at top of wall at Maximum -load: -2.04 in.

Average maximum load: 1149 plf
Average net displacement: 1.98 in.

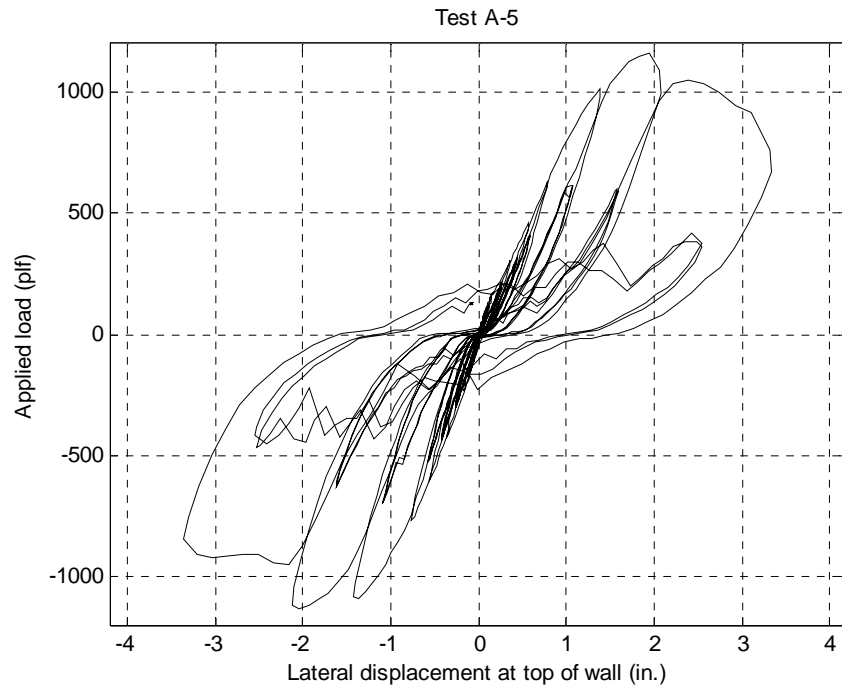

Observed Failure Mode: the steel sheet buckled and pulled off the frame at the center of the interior stud, outer flange of one double stud distorted.





Test Label A-6

Test Date August 7, 2007

Specimen Configuration

Wall dimensions: 4 ft. × 8 ft. Studs: 350S162-43, 24 in. o.c. Tracks: 350T150-33 Steel sheathing: 0.027 in.
Fastener: #8×18-1/2" modified truss head self-drilling tapping screw, 4 in. o.c. on the perimeter, 12 in. o.c. in the field. Screws on outer flanges.

Test protocol: Cyclic CUREE

Test results

Maximum +load: 954 plf
Net lateral displacement at top of wall at Maximum +load: 1.40 in.

Maximum -load: -860 plf
Net lateral displacement at top of wall at Maximum -load: -1.37 in.

Average maximum load: 907 plf
Average net displacement: 1.38 in.

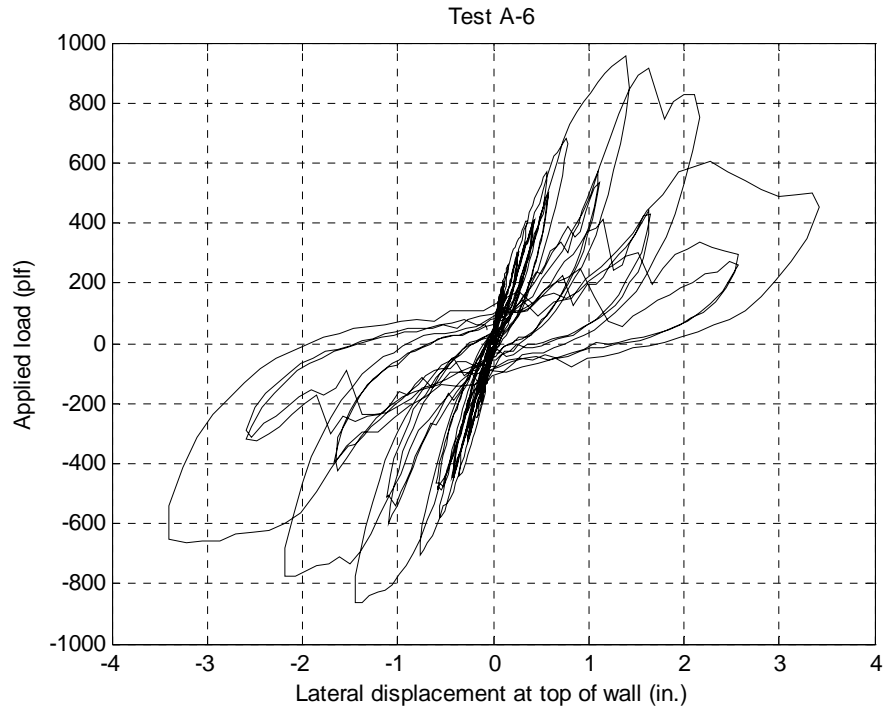

Observed Failure Mode: the steel sheet buckled and pulled off the frame at the middle of the interior stud, and the bottom portion of the boundary studs.





APPENDIX D

QUALITY CONTROL PROCESS OF UNT STRUCTURAL TESTING LABORATORY FOR TESTS ON LIGHT FRAMED LATERAL FORCE RESISTING ASSEMBLIES

1. Objectives

The purpose of this appendix is to describe the quality control process used by the UNT Structural Testing Laboratory for tests on light frame lateral force resisting assemblies. The requirements outlined in this appendix shall be followed unless changes or revisions are required and then documented

2. Quality Standards

The testing procedures shall be consistent with or exceed the requirements of national approved standards such as the American Society for Testing and Materials (ASTM) and the International Code Council, Evaluation Service (ICC-ES) as appropriate.

The supply and installation of these materials will be in strict accordance with the Specifications and engineering drawings. Deviation from the standards and procedures described in this document will only be as required for unique project specifications, according to the terms and conditions of the contract. Conformance to the established policies and procedures described herein will be monitored by internal audits on a random basis.

3. Materials

3.1 Material Inspection

All materials will be inspected for damage, deterioration, and correct dimensions prior to assembly. Any material used that has damage or incorrect dimensions will be replaced and noted in the test summary.

3.2 Sheathing Materials

Shear wall sheathing materials will include but not limited to, cold formed sheet steel in accordance with ASTM A1003 Grade 33 Type H.

3.3 Framing and sheathing fasteners were randomly selected from local retailers. Hold-down anchor bolts and shear anchor bolts were also randomly selected from local retailers.

3.4 Hold-downs were provided by Simpson Strong-Tie as they typically provide their vendors.

4. Wall Assemblies

Panels will be constructed to specific dimensions 8 ft by 8 ft, 8 ft by 4 ft, or 8 ft by 2 ft depending on the requirements of a test program. Studs will be fastened to a single top and bottom track member on 16" or 24" o.c.

Wall assemblies shall be constructed with fasteners having approved values. Connections must be detailed or adequately described including fastener type, size, length and location.

5. Test Program

5.1 Testing Equipment

Laboratory testing equipment is certified and traceable to the standards of the National Institute of Standards and Traceability (NIST).

Test equipment used includes, but not limited to:

- MTS 505.07 Hydraulic pump
- MTS 244.23 Hydraulic actuator 35 kip 10 in stroke
- MTS 407 Controller
- National Instruments PCI6225 DAQ, SCXI1100 chassis
- National Instruments SCXI1520 Load Cell Module
- National Instruments SCXI1540 LVDT Module
- Techniques SWO – 10 kip load cell
- Novotechnic LWH T/TS series position transducers

Test Setup

The monotonic test setup shall be in accordance with the ASTM E564. The cyclic test setup shall be in accordance with the ICC-ES AC130.

Calibration

The load cell and position transducer shall be calibrated annually or per the recommendation by the manufacturers. The data acquisition system shall be checked for accuracy before the initiation of and after the completion of the test program.

Test Report

The test report shall conform to the criteria stipulated in ICC-ES AC85. The content shall, at a minimum, consist of the following:

- 5.4.1 Name, address and telephone number of the testing laboratory
- 5.4.2 Unique identification number(s) of the test report as determined by test program sponsor, if required, and by the test lab, if the test lab so requires.
- 5.4.3 The report shall be paginated and the total number of pages indicated.
- 5.4.4 Date of testing and date of the report.
- 5.4.5 The test standard with date of issue and explanation of any deviation from the standard.
- 5.4.6 Description of the product or system tested and the source of the test samples.
- 5.4.7 If assemblies are tested, a description shall be provided of the assemblies, preferably with illustrations. Also, the report shall address who witnessing and/or verifying the construction.
- 5.4.8 Description of the test procedure
- 5.4.9 Any specifics required by the test standard such as ambient conditions, graphs, calculations, drawings, photographs and result interpretation, if required.
- 5.4.10 Failure mode with a description of the failure.
- 5.4.11 Conclusions or summary statements.



American Iron and Steel Institute

1140 Connecticut Avenue, NW
Suite 705
Washington, DC 20036
www.steel.org



Steel Framing Alliance™

Steel. The Better Builder.

1201 15th Street, NW
Suite 320
Washington, DC 20005
www.steel framing.org

