

research report

Development of Cost-Effective, Energy Efficient Steel Framing: Structural Performance of Slit-Web Steel Wall Studs

RESEARCH REPORT RP02-8

2002

REVISION 2006



American Iron and Steel Institute



Steel Framing Alliance™

Steel. The Better Builder.

DISCLAIMER

The material contained herein has been developed by researchers based on their research findings and is for general information only. The information in it should not be used without first securing competent advice with respect to its suitability for any given application. The publication of the information is not intended as a representation or warranty on the part of the American Iron and Steel Institute, Steel Framing Alliance, or of any other person named herein, that the information is suitable for any general or particular use or of freedom from infringement of any patent or patents. Anyone making use of the information assumes all liability arising from such use.

PREFACE

This report presents the results of structural tests that were performed at the NAHB Research Center on a prototype slit web stud. Based on this work, and that of the companion report on Thermal Performance of Slit-Web Steel Wall Studs, it is hoped that manufacturers may have interest in commercializing the thermal stud. The reader is cautioned that the Research Team had the following specific questions and concerns related to the report:

- From the photos it appears that the flexural tests failed in a combination of bending and web crippling. No reinforcement was added to the webs to preclude a web crippling failure at the load application. This may explain the failure mode being reported as “local buckling under the point load”. Comparisons should have been made between the tests of the solid web stud and the AISI Specification calculations. There is insufficient information in the report to determine the test failure moment and the mode of failure for the solid web studs.
- There are no photos of the solid web stud tests and it is unclear whether they had standard perforations. This would affect the calculated capacities.
- A portion of the difference in strength is attributed to the higher yield and ultimate strength values of 27% and 30%. Per Table A1, the difference in yield is only 13%.
- The bracing of the two members in the axial tests precluded anything but local buckling. The results of the stub-column tests, essentially the same as the axial tests, confirm this.
- Table 7 gives the shear test results, but is not clear whether these are the test loads or the failure shear values.
- The results of the axial tests of the solid web studs should be compared with the AISI Specification. Since these were essentially stub column tests, the results should be able to be calculated.
- The shear test set-up seems to be unnecessarily complex. Most shear tests are carried out on short specimens reinforced to prevent a flexural or web crippling failure. The report concluded that failure was localized buckling of the flanges under the point load. This does not sound like a shear failure, but may be combined shear and bending.
- The shear wall tests are not relevant to the investigation of the strength of the member by itself. Also, the shear walls tested experienced premature failures (first due to the hold-down tearing out of the web and then due to an inadequate number of chord studs). This precluded any meaningful conclusions to be reached regarding their performance.
- Web crippling tests were not conducted. The report implies that web crippling would not need to be investigated for fully sheathed walls; however, this statement is not necessarily correct. Industry experts advise that web crippling would need to be tested even for sheathed walls, but definitely for unsheathed walls.
- The report concludes that the slit web stud “performed similar to or better than a solid-web stud”. While this is true for the tests carried out, there is some question whether the desired failure mode was achieved. It should be recommended that additional tests be carried out to isolate the specific failure modes (shear, web crippling, distortional buckling, overall buckling) to verify the behavior.

Research Team
Steel Framing Alliance

Development of Cost-Effective, Energy -Efficient Steel Framing

Structural Performance of Slit-Web Steel Wall Studs

Prepared for

American Iron and Steel Institute
Washington, DC

And

Steel Framing Alliance
Washington, DC

And

The U.S. Department of Energy
Washington, DC

by

NAHB Research Center, Inc.
400 Prince George's Boulevard
Upper Marlboro, MD 20774-8731

October 2002

DISCALIMER

“Any opinions, findings, and conclusions or recommendations expressed in this material are those of the author(s) and do not necessarily reflect the views of the US Department of Energy.”

Number of pages in this report: 62

This report has been reproduced from the best available copy. For availability contact: Office of Scientific and Technical Information, P. O. Box 62, Oak Ridge, TN 37831. (615) 576-8401.



ACKNOWLEDGEMENTS

This report was prepared by Nader Elhajj, P.E., of the NAHB Research Center, Inc., for the American Iron and Steel Institute (AISI), the Steel Framing Alliance and the U.S. Department of Energy. The NAHB Research Center staff involved in this project are:

Project Manager	Nader Elhajj
Technical Reviewer	Jay Crandell
Lab Technicians	Brian Adgate Ayman Al-Hajj Stuart Denniston
Administrative Support	Lynda Marchman

Appreciation is especially extended to members of the steering committee (listed below) who provided guidance and whose input contributed to this work.

Kevin Bielat	American Iron and Steel Institute
Randy Daudet	Dietrich Industries
Nader Elhajj	NAHB Research Center
Steve Fox	Canadian Sheet Steel Building Institute
Jonathan Humble	American Iron and Steel Institute
Dr. Roger LaBoube	University of Missouri - Rolla
Jay Larson	Bethlehem Steel Corp.
Don Moody	Nucor Steel
Peter Salmon-Cox	U.S. Department of Energy
J. Stone	U.S. Department of Energy
Joe Vehec	American Iron and Steel Institute
Tim Waite	Steel Framing Alliance

Structural Performance of Slit-Web Steel Wall Studs





TABLE OF CONTENTS

<u>Content</u>	<u>Page</u>
TABLE OF CONTENTS.....	v
LIST OF FIGURES	vii
LIST OF TABLES	ix
EXECUTIVE SUMMARY	xi
ABSTRACT.....	xii
Introduction.....	1
Purpose.....	1
Literature Review.....	1
Experimental Approach	6
Results.....	14
Failure Mode.....	17
Discussion.....	17
Conclusion	19
References.....	20
Appendix A – Test Results	A1-A14
Appendix B – Test Photos	B1-B8

Structural Performance of Slit-Web Steel Wall Studs





LIST OF FIGURES

<u>Figure</u>		<u>Page</u>
Figure 1	Bethlehem Steel Slit-Web Stud	2
Figure 2	Concentric Compression Tests	2
Figure 3	Eccentric Compression Tests	3
Figure 4	Stud Pullout Test Results	3
Figure 5	Web Perforated Steel Stud Tested by Kesti	4
Figure 6	Swedish Slit-Web Stud Profile	5
Figure 7	Thermoprofile Stud	5
Figure 8	Prototype of Slit Web Stud	6
Figure 9	Slit-Web Stud Configuration and Dimensions	6
Figure 10	Slit-Web Stud Configuration and Dimensions	7
Figure 11	Bending Test Setup	9
Figure 12	Section A-A	9
Figure 13	Axial Load Test Setup	10
Figure 14	Stub-Column Test Setup	11
Figure 15	Shearwall Test Setup	
Figure 16	Shear Test Setup	13

Structural Performance of Slit-Web Steel Wall Studs



Structural Performance of Slit-Web Steel Wall Studs



LIST OF TABLES

<u>Table</u>		<u>Page</u>
Table 1	Wall Assembly Sheathing Arrangement	1
Table 2	Average Tensile Test Results	14
Table 3	Bending Load Test Results	14
Table 4	Axial Load Test Results	15
Table 5	Stub-Column Test Results	15
Table 6	Shearwall Test Results	16
Table 7	Shear Test Results	16
Table 8	Shear Load Comparison	18

Structural Performance of Slit-Web Steel Wall Studs



Structural Performance of Slit-Web Steel Wall Studs



EXECUTIVE SUMMARY

Steel members in wall construction form a thermal bridge that interrupts the insulation layer of a wall. This causes higher rate of heat transfer by conduction through the wall framing than through other parts of the wall. The objectives of this project are to analyze and design components and systems for the construction of homes using cold-formed steel whose thermal performance meets energy code requirements in a cost-effective manner, and to document system performance through thermal testing.

A thermally efficient slit-web stud was developed in this program to mitigate the conductivity of steel. The prototype slit-web steel stud has been shown to be:

- Thermally efficient
- Economically viable
- Structurally sound
- Easily manufactured
- Usable in a range of residential installations (“Buildable”)

The behavior of 3-1/2 inch (89 mm) slit-web stud (perforated web) was evaluated and test results showed that the prototype slit web stud performed similar to or better than a solid-web stud in bending, axial, and shear tests. The shearwall test results indicated the importance of using multiple chord studs and the need to address the connection to the tension chord end stud where heavy connections are made and locally high compressive and tension forces must be transferred through connections or bearing of end studs. Tests also showed that the slit-web stud is very sensitive to the distortional buckling mode. The 350S162-33 slit-web stud tested in this report was shown to be better than or essentially equivalent to a 350S162-33 solid-web stud in most structural performance characteristics investigated. Web crippling was not investigated for the slit-web stud, as it is not considered a failure mode for wall studs that are fully sheathed with structural sheathing. Web crippling strength should be investigated when slit-web studs are used in non-sheathed wall applications.

Structural Performance of Slit-Web Steel Wall Studs



ABSTRACT

The behavior of 3-1/2 inch (89 mm) slit-web stud (perforated web) was evaluated by performing axial, bending, shear, shearwall, and stub column tests. Test results indicated that the prototype slit web studs performed similar to or better than solid-web studs in bending, axial, and shear tests. The shearwall test results indicated the importance of using multiple chord studs and the need to address the connection to the tension chord end stud where heavy connections are made and locally high compressive and tension forces must be transferred through connections or bearing of end studs. Tests showed that slit-web studs are very sensitive to the distortional buckling mode. The 350S162-33 slit-web studs tested in this report were shown to be better than or essentially equivalent to 350S162-33 solid-web studs in most structural performance characteristics investigated. Web crippling was not investigated for the slit-web stud in this report. Web crippling strength should be investigated when slit-web studs are used in non-sheathed wall applications.

Structural Performance of Slit-Web Steel Wall Studs



INTRODUCTION

Cold-formed steel framing has seen some market growth in the housing market most probably due to its similarity to wood stick framing. However, due to concerns about the thermal performance of steel, the use of steel framing in the residential market is still relatively low.

The American Iron and Steel Institute (AISI) initiated a multi-year program with funding from the U.S. Department of Energy (DOE) through the Technology Roadmapping Program (TRP) to investigate the thermal conductivity of cold-formed steel framed walls in residential construction and develop a thermally efficient stud. Prior to this program, the only nonproprietary commercially available thermal break for steel-framed walls was the use of rigid foam on the exterior of a steel-framed wall as specified in the *Thermal Design Guide* [1]. Other available products and construction methods and materials are mostly proprietary products, not widely available, or too costly. Even the exterior rigid foam insulation requirements specified in the *Thermal Design Guide* can be costly and inefficient in colder climates as the foam thickness can be up to 2 inches (51 mm) to achieve a required (effective) R-value.

The *Thermal Performance of Slit-Web Steel Wall Studs* report [2] investigated available options that mitigate the thermal conductivity of steel framing and developed and tested a slit-web stud that is thermally efficient. The newly developed stud can provide a solution to users once its structural characteristics are proved to be equivalent to that of a solid-web stud.

PURPOSE

The objective of this report is to document the structural performance of the slit-web stud (SWS) as developed in the thermal report [2]. The testing includes axial, bending and web crippling. This report also compares the test results of the SWS to those of a solid web stud.

LITERATURE REVIEW

Numerous papers have been written about the structural behavior of slit-web studs. The most comprehensive study was done by Bethlehem Steel Corporation in 1974 [3]. The Bethlehem Steel study investigated slit-web stud wall systems (4 ft. x 8 ft.) (1219 mm x 2438 mm) under concentric compression, eccentric compression, transverse load, and racking load. The primary components of the wall systems were cold-formed channel C-shaped 3-1/2" x 1-1/2" x 0.36" (20 gauge) (89 x 38 x 9 mm) studs which snap-lock into a top and bottom steel track (see Figure 1). The studs were spaced at 24 inch on center. The studs had slits in the webs and 3/4" (19 mm) diameter utility holes. Wall assembly sheathing arrangement is described in Table 1.

Table 1 – Wall Assembly Sheathing Arrangement

Test No.	1/2" Drywall/ 1/2" Gyplab	1/2" Drywall/ 1/2" Drywall	Gyplab One Side	No Sheathing	1/2" Plywood/ 1/2" Drywall
1,2,3,5	√				
4,6,7,10		√			
8				√	
9			√		
12,13	√				
11,14,15					√

Structural Performance of Slit-Web Steel Wall Studs



The study concluded that the design of the thermal slits in the studs, particularly when they extend to the ends of the studs, significantly reduce the strength of the wall panels. Summary of test results is shown in Figures 2 through 4. The stud pullout test results shown in Figure 4 were based on single studs.

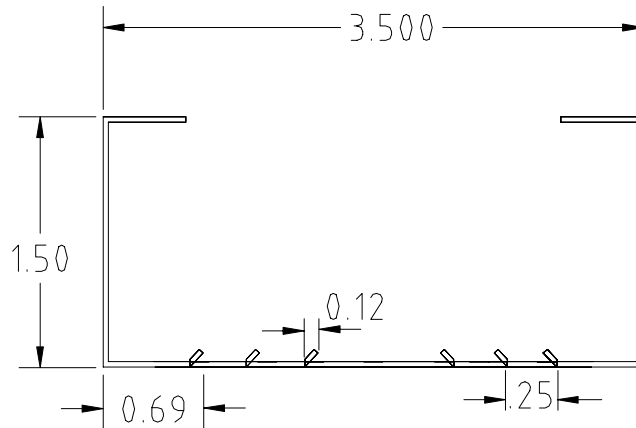

**Figure 1 – Bethlehem Steel Slit-Web Stud
(Dimensions in inches)**

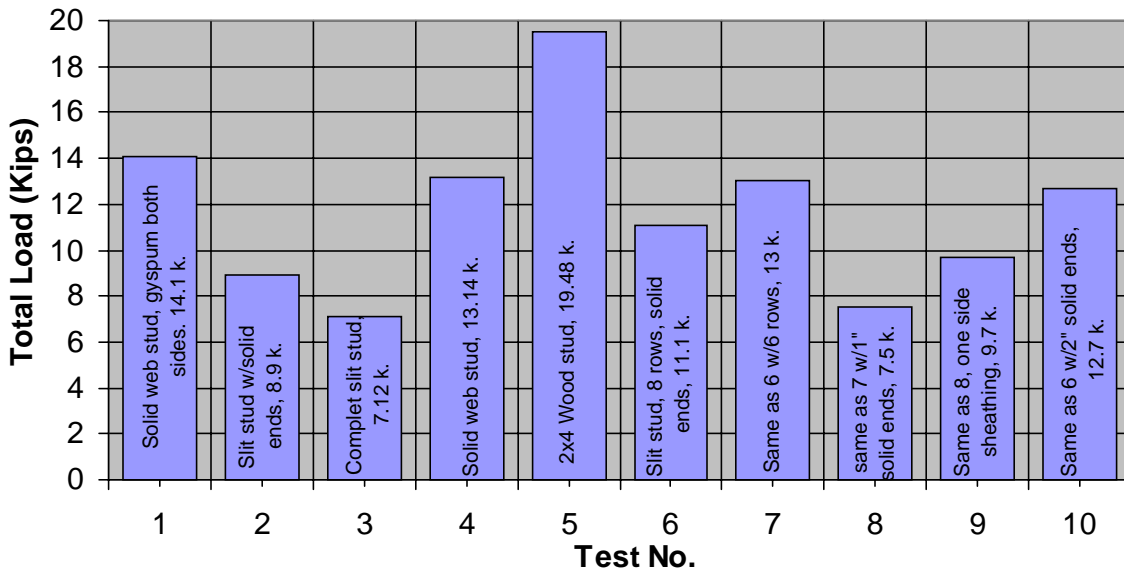

Figure 2 – Concentric Compression Tests

Structural Performance of Slit-Web Steel Wall Studs

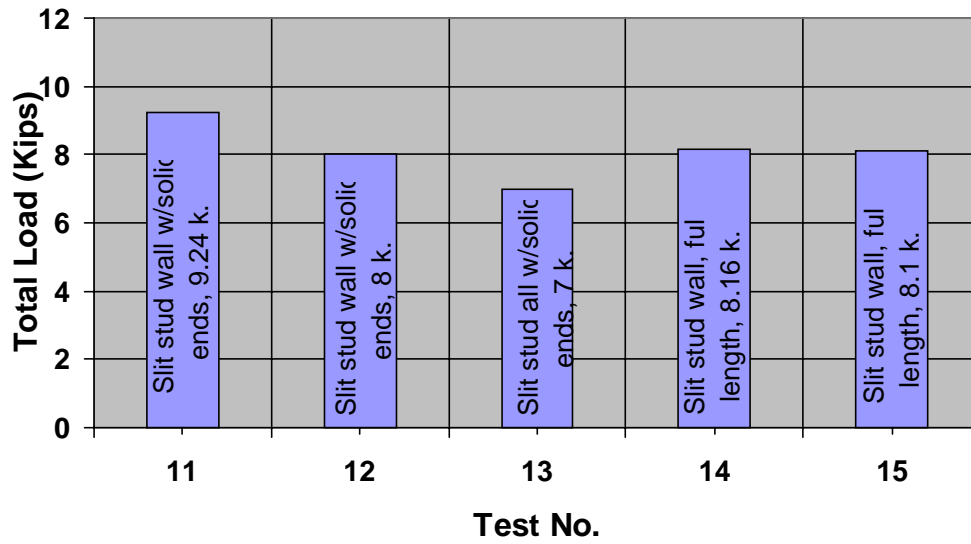

Figure 3 – Eccentric Compression Tests

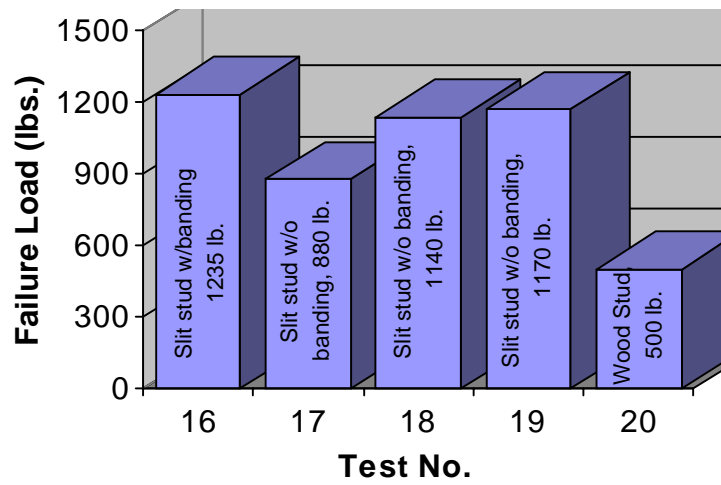

Figure 4 – Stud Pullout Test Results

Structural Performance of Slit-Web Steel Wall Studs



Ratliff and Roeder conducted full-scale structural tests on steel wall panels constructed of slit-web studs [4]. Test results showed that the full scale compression-load tests of 4-foot (1219 mm) wide wall panels made with slit studs supported 12.8 kips (56.93 kN) compared with 12.2 kips (54.27 kN) for 4-foot (1219 mm) wide panels made with standard unslit studs. The results of the full-scale wind load tests showed that 4-foot (1219 mm) wide wall panels made with slit web studs supported a uniform load of 150 psf. The results of the short-column compression tests indicated that the compression load capacity of light-gauge steel stiffened channel section with slit webs was about 17 percent less than that of similar sections with un-slit webs.

Kesti investigated the structural capacity of web-perforated steel wall studs (see Figure 5) at Helsinki University [5]. Kesti concluded that the perforation changes the behavior of the stud under compressive and lateral loading, reduces the shear stiffness and shear strength of the stud, and also decreases the bending stiffness of the web causing decreased distortional buckling strength. Kesti investigated structures consisting of studs with perforated cold-formed sigma-profiles and gypsum wallboards attached to the stud flanges. The aim was to determine compression and bending moment capacities by full scale testing. The wall stud assemblies were subjected to combined axial and lateral loading. Kesti reported that the test specimens failed by distortional buckling of the upper (tension) flange while fasteners pulled through the sheathing boards. Stub column tests were conducted to evaluate the local and distortional buckling behavior of the stud sections.



Figure 5 – Web Perforated Steel Stud Tested by Kesti

A slotted light-gauge steel stud was developed in Sweden for load-bearing external walls in single-family homes and infill walls in blocks of flats (see Figure 6). The slots are about 2.75 inches in length, and the distance between them in the longitudinal direction is 0.8-1 inch (20.3 – 25.4 mm) and in the transverse direction 1/4 - 3/8 inch (6.4 – 9.5 mm). The edges of the slots are folded inward and form edge stiffeners, which increase the buckling strength. In order to increase the strength further, the web is sometimes folded or given a longitudinal groove in the center. In most cases, the web has two panels with five rows of slots between them, while in smaller sections there are fewer rows of slots.

The Swedish Institute of Steel Construction [6][7] reported that several failure modes have been observed in tests of steel wall panels constructed with slotted steel studs, such as:

1. Flexural buckling in the plane of the web.
2. Lateral buckling of flanges in compression.
3. Shear failure of the slotted web.
4. Failure due to support reaction.
5. Failure under concentrated force.

Structural Performance of Slit-Web Steel Wall Studs



6. Buckling of the edges of the flanges in the span (axial force and bending moment).
7. Buckling of the edges of the flanges at the supports (axial force).

In all cases, the capacity of the wall panel is affected by shear deformation of the slotted web and by the reduced transverse bending stiffness of the web.

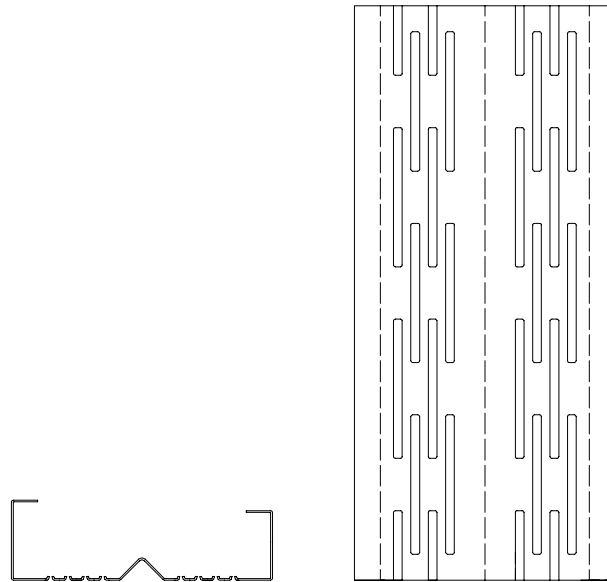

Figure 6 – Swedish Slit-Web Stud Profile

A Finnesteel Programme developed a thermoprofile stud in which the perforations were located in the middle part of the stud web in order to increase the bending stiffness (see Figure 7). In addition, longitudinal stiffeners stiffened the web to increase the overall buckling resistance of the profile [8]. Design guidance and design charts were developed for the thermoprofile stud.

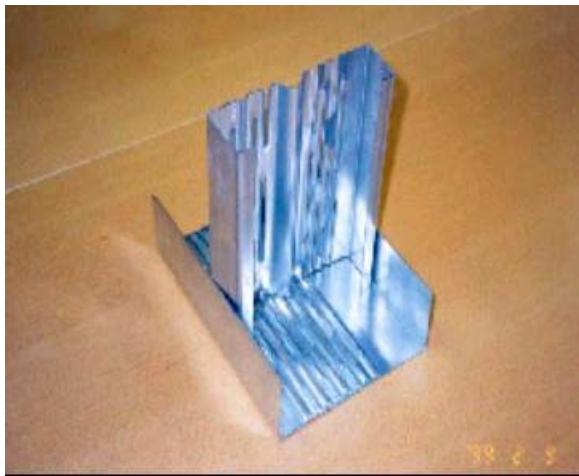

Figure 7 – Thermoprofile Stud

Structural Performance of Slit-Web Steel Wall Studs



EXPERIMENTAL APPROACH

The slit-web stud (see Figures 8, 9 and 10) that was thermally tested in previous report [2] was structurally evaluated in this report. Axial and bending tests were performed on single studs and the resulting capacity was compared to that of solid-web studs. All steel materials had a minimum specified tensile strength of 33 ksi (228 MPa) as verified by tensile tests in accordance with ASTM A370 [9]. Tensile tests were performed on a sample of three specimens for each stud thickness. Base steel thicknesses were measured in accordance with ASTM A90 [10]. Mechanical properties were based on coupons cut longitudinally from the center region of the specimen's web.



Figure 8 – Prototype of Slit Web Stud

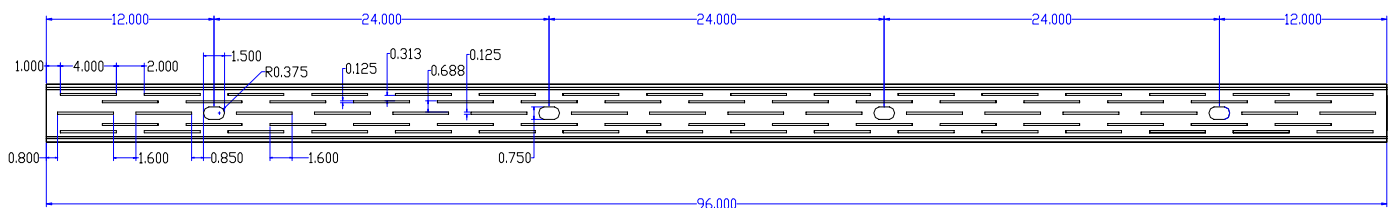

Figure 9 – Slit-Web Stud Configuration and Dimensions
(Dimensions in inches)

Structural Performance of Slit-Web Steel Wall Studs

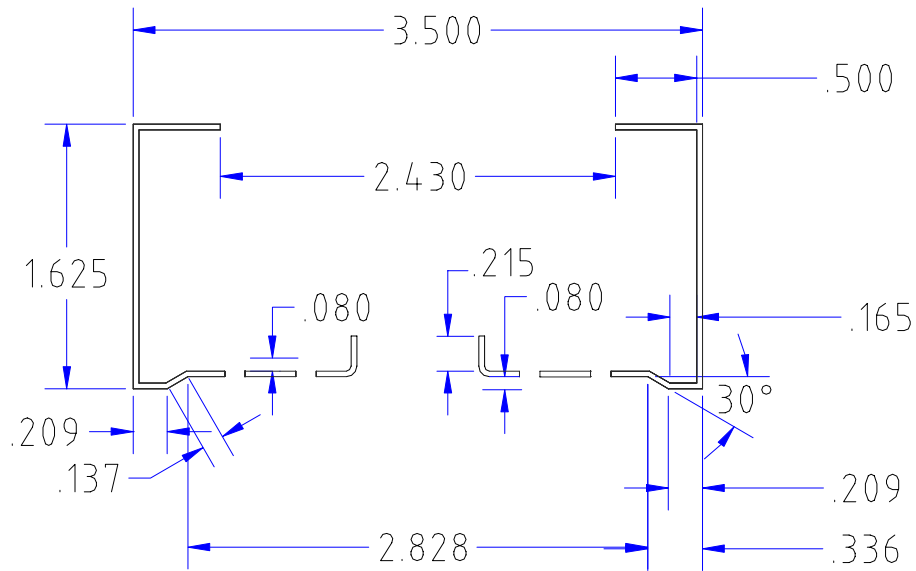
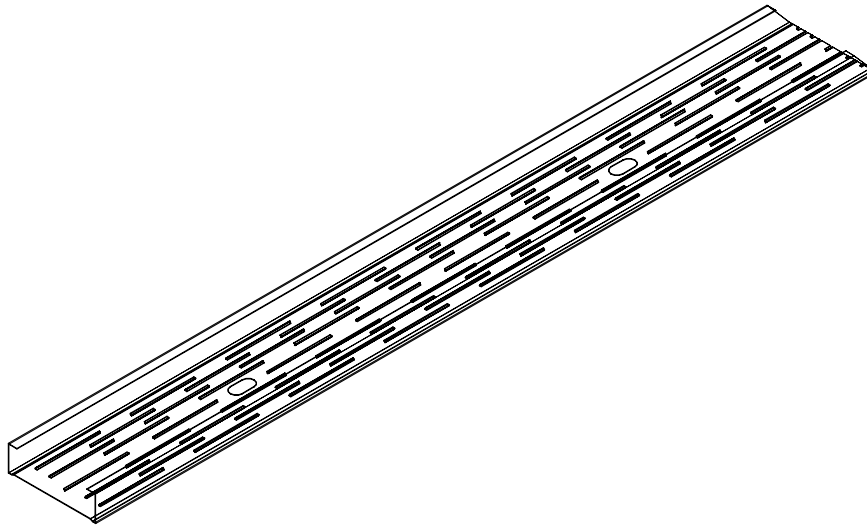

Figure 10 – Slit-Web Stud Configuration and Dimensions
(Dimensions in inches)

Structural Performance of Slit-Web Steel Wall Studs



Bending Tests

Test Procedure

The specimens were tested in the NAHB Research Center's Universal Testing Machine (UTM). No standard ASTM test procedure is specifically detailed for testing cold-formed steel beams subjected to third point loading or to steel wall studs subjected to axial loads. Therefore, the test set-up was similar to that specified in ASTM D198 [11] using simple beams with third-point loading. The standard requires specimens to be mounted in a testing apparatus capable of applying measurable loads at a constant load rate.

The following information was recorded and reported for each test:

- Depth, width, and return lip of specimens,
- Built-up member length,
- Loading configuration,
- Rate of load application,
- Support condition and any lateral supports used,
- Actual physical and mechanical properties of cold-formed steel materials, including thickness, yield strength, ultimate strength (coupon tests), and a statistical measure of variability of these values
- Description of observed failure mode, and,
- Ultimate loads and deflections.

Test Specimen and Test Configuration

The crosshead of the UTM was fitted with an apparatus capable of applying the total load at two points equidistant from the reactions. The locations of the two point loads and end reactions divide the specimen (bending test) into three equal sections. The load was applied by the UTM and transmitted to the load plates and roller (pivots) by a crossbeam.

The purpose of this test was to investigate the bending capacity of slit-web stud member (350S162-33) stabilized against lateral-torsional buckling. To stabilize the specimen against lateral-torsional buckling, each test specimen consisted of two slit-web studs inter-connected by 7/16-inch (11 mm) thick oriented-strand-board (OSB) or plywood and 33 mil (0.81 mm) tracks. The 10-inch x 12-inch x 7/16-inch (254 mm x 305 mm x 11 mm) wood strips were spaced at 16-inches (406 mm) on center and fastened to top and bottom flanges with No. 8 self-drilling, tapping screws (two screws per flange). The 33 mil (0.84 mm) tracks were fastened to ends of the studs (two track sections per assembly) using No. 8 self-drilling tapping screws. The test set up is shown in Figures 11 and 12. The assembly was restrained at each end from moving laterally and rotating. Rollers and bearing plates were used at each end of the assembly. Two concentrated loads were applied at third point locations of each specimen through a 1-5/8 inch (42.5 mm) thick bearing plate and roller. This loading arrangement provided a pure moment region in the central portion of the beam while the two end sections experienced a linearly increasing bending moment with increasing distance from the ends. A deflection gage was placed under the assembly at mid-span to measure the vertical deflection of the test specimen.

Structural Performance of Slit-Web Steel Wall Studs

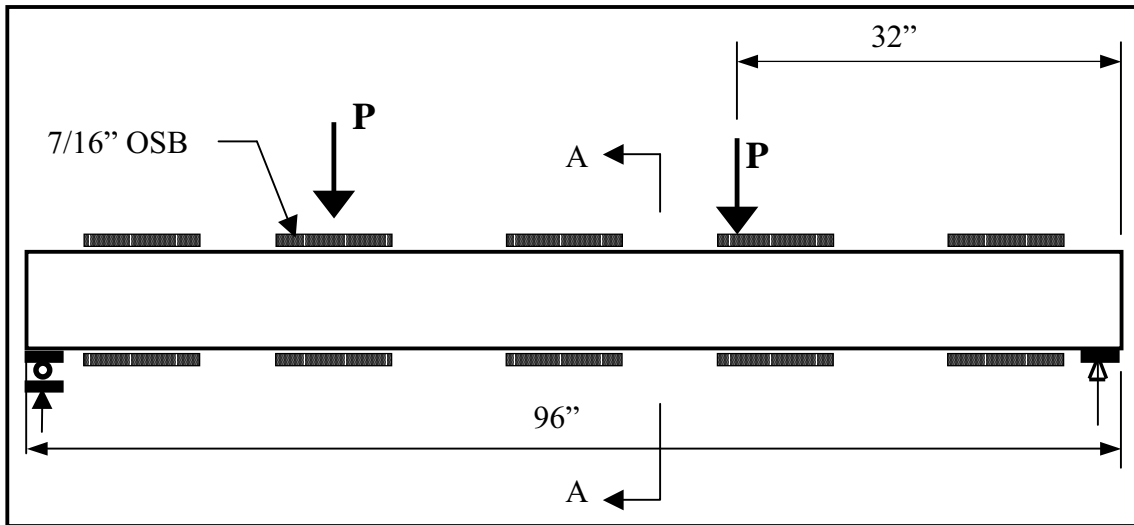

Figure 11 - Bending Test Setup

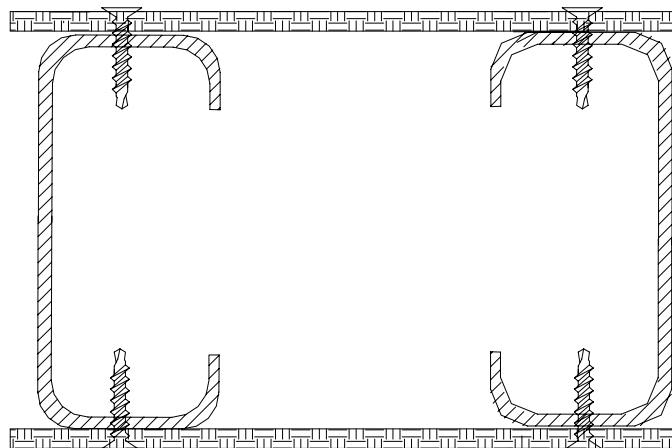

Figure 12 - Section A-A

Structural Performance of Slit-Web Steel Wall Studs



Axial Tests

Test Procedure

The specimens were tested in the NAHB Research Center's Universal Testing Machine (UTM). No standard ASTM test procedure is specifically detailed for testing cold-formed steel columns subjected to pure axial loads. The AISI Design Specification [12] provides a test method for steel stub column tests. ASTM E72 [13] provides a standard test method for wall panels subject to axial load. The ASTM E72 test method was used to establish the axial load capacity of the slit-web stud.

Test Specimen and Test Configuration

The purpose of this test was to investigate the axial capacity of a slit-web stud member (350S162-33) stabilized against lateral-torsional buckling. To stabilize the specimen against lateral-torsional buckling, each test specimen consisted of two slit-web studs inter-connected by 7/16-inch (11 mm) thick oriented-strand-board (OSB) and plywood and 33-mil (0.84 mm) tracks as shown in Figure 13. The 10-inch x 12-inch x 7/16-inch (254 mm x 305 mm x 11 mm) wood strips were spaced at 16-inches (406 mm) on center and fastened to top and bottom flanges with No. 8 self-drilling, tapping screws (two screws per flange). The 33-mil (0.84 mm) tracks were fastened to ends of the studs (two track sections per assembly) using No. 8 self-drilling tapping screws. The axial load was applied through a pivot and thick steel plate to distribute the axial loads equally between both members. A deflection gage was placed at mid-span on one side of the assembly to measure out-of-plane deflection.

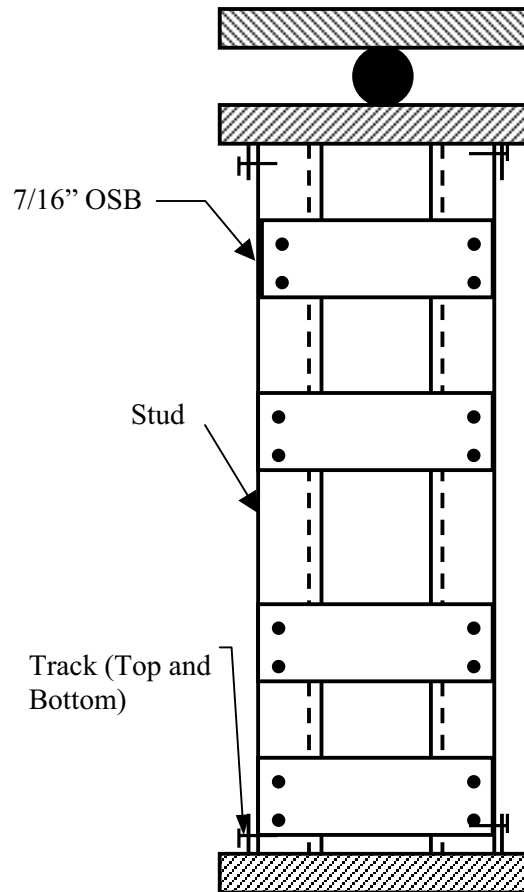

Figure 13 – Axial Load Test Setup

Structural Performance of Slit-Web Steel Wall Studs



Stub-Column Test

Test Procedure

Stub-column specimens were tested in the NAHB Research Center's Universal Testing Machine (UTM). The AISI Design Specification [12] stub-column test method was used to determine the effective cross-sectional area of the slit-web stud.

Test Specimen and Test Configuration

Three identical stub-column specimens (350S162-33 slit web stud) were tested as required by the AISI Design .02 Specification. The length of the specimens were determined to be sufficiently short to eliminate overall column buckling effects and sufficiently long to minimize the end effects during loading. The test set up is shown in Figure 14.

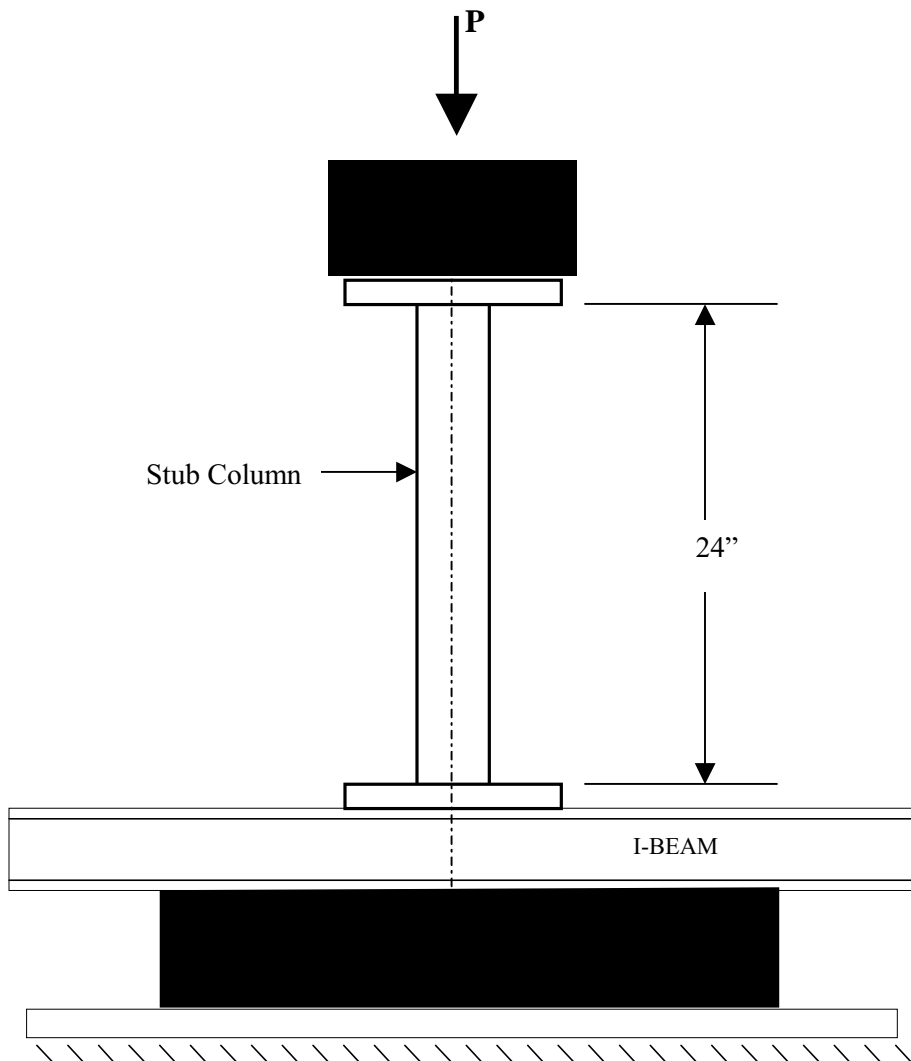

Figure 14 – Stub-Column Test Setup

Structural Performance of Slit-Web Steel Wall Studs



Shear Wall Test

Test Procedure

The specimens were tested in the NAHB Research Center's "Racker" test apparatus utilizing the ASTM E564 [14] test method. The monotonic (with no load reversal on release) load protocol was used.

Test Specimen and Test Configuration

The main purpose of the test is to determine the shear capacity, stiffness, and failure mode of the slit-web stud wall assembly. One 8 ft x 8 ft (2438 x 2438 mm) shear wall using 5 thermal studs spaced at 24 inches (610 mm) on center was constructed and tested according to the ASTM E 564 test set-up. The top and bottom tracks were standard cold-formed steel, 33-mil (0.84 mm) material. The wall was sheathed on one side with 7/16 OSB (11.11 mm) (fastened at standard 6" edge / 12" (152/305 mm) field screw spacing using No. 8 counter-sink head self-drilling, tapping screws or sharp point). The opposite side was sheathed with 1/2" (12.7 mm) gypsum wallboard (drywall), fastened using No. 6 sharp point drywall screws spaced at 12 inches (305 mm) on center. The drywall was not taped and mudded with joint compound. Test setup is shown in Figure 15.

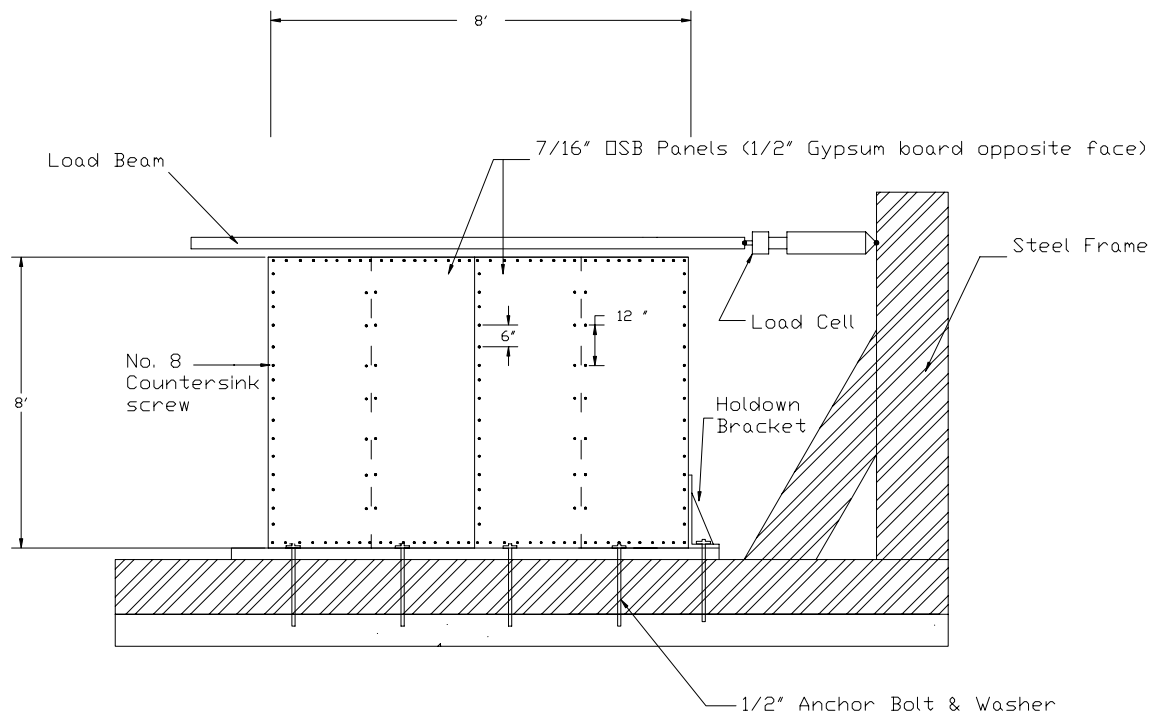

Figure 15 - Shearwall Test Setup

Structural Performance of Slit-Web Steel Wall Studs



Shear Tests

Test Procedure

The specimens were tested in the NAHB Research Center's Universal Testing Machine (UTM). No standard ASTM test procedure is specifically detailed for testing cold-formed steel beams for shear. The shear test setup shown in Figure 16 is a typical setup that is widely used by the steel industry.

Test Specimen and Test Configuration

The main purpose of the test is to determine the shear strength of the slit-web stud. Each test specimen consisted of two slit-web studs connected to 33-mil (0.84 mm) tracks at the ends, with No. 8 self-drilling tapping screws. The load was applied through a pivot and thick steel plate to distribute the loads equally between both members. A deflection gage was placed under the point load between the supports to measure vertical deflection.

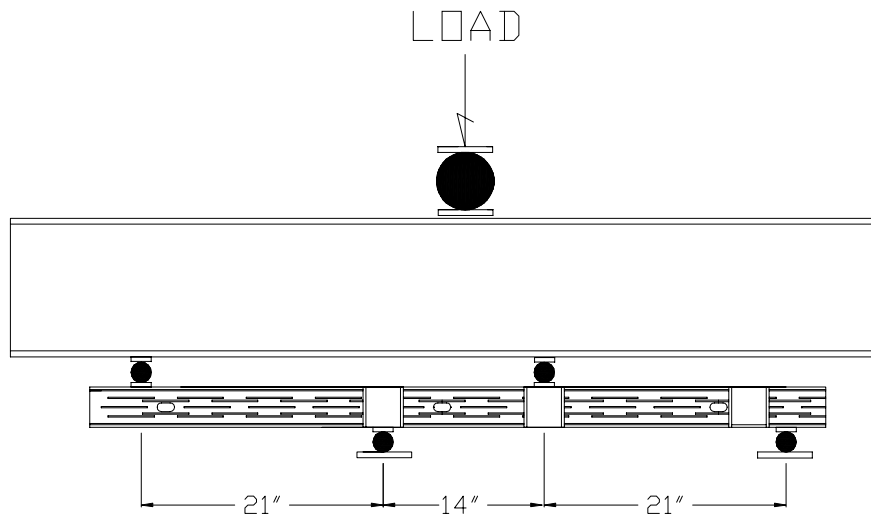

Figure 16 – Shear Test Setup

Structural Performance of Slit-Web Steel Wall Studs



RESULTS

The results of the structural tests are summarized in this section.

Tensile Tests

Results of coupon tests on the slit-web and the solid-web studs are included in Appendix A. Table 2 provides a summary of the test results.

Table 2 – Average Tensile Test Results

Stud Size	Stud Thickness (mil)	Stud Web Type	Yield Strength (psi)	Ultimate Strength (psi)	Thickness (inches)
350S162-33	33	Slit Web	43,650	60,320	0.0341
350S162-33	33	Solid Web	34,400	46,500	0.0340

For SI: 1 mil = 1/1000 inch = 0.0254 mm, 1 psi = 0.0703 kg/cm²

Bending Tests

Table 3 presents the results of the bending load tests for the slit web stud and similar solid web studs. The solid web studs were tested in the same manner and configuration as the slit web studs. Load-deflection curves are shown in Appendix A.

Table 3 - Bending Load Test Results

Test No.	Stud Size	Stud Thickness (mil)	Stud Web Type	Ultimate Load (lb.)
1	350S162-33	33	Slit Web	519
2	350S162-33	33	Slit Web	496
3	350S162-33	33	Slit Web	517
Average				511
Standard Deviation				12.74
COV				0.02
4	350S162-33	33	Solid Web	348
5	350S162-33	33	Solid Web	310
6	350S162-33	33	Solid Web	361
Average				340
Standard Deviation				26.50
COV				0.08

For SI: 1 mil = 1/1000 inch = 0.0254 mm, 1 lb = 4.448 N

Structural Performance of Slit-Web Steel Wall Studs



Axial Tests

Table 4 presents the results of the axial load tests for the slit-web stud and solid web studs. The solid web studs were tested in the same manner and configuration as the slit-web studs. Load-deflection curves are shown in Appendix A.

Table 4 – Axial Load Test Results

Test No.	Stud Size	Stud Thickness (mil)	Stud Web Type	Ultimate Load (lb.)
7	350S162-33	33	Slit Web	3,882
8	350S162-33	33	Slit Web	3,950
9	350S162-33	33	Slit Web	4,250
Average				4,027
Standard Deviation				195.81
COV				0.05
10	350S162-33	33	Solid Web	2,900
11	350S162-33	33	Solid Web	2,875
12	350S162-33	33	Solid Web	2,550
Average				2,775
Standard Deviation				195.26
COV				0.07

For SI: 1 mil = 1/1000 inch = 0.0254 mm, 1 lb = 4.448 N

Stub-Column Tests

Table 5 presents the results of the stub-column tests for the slit web stud. Load-deflection curves are shown in Appendix A.

Table 5 – Stub-Column Test Results

Test No.	Stud Size	Stud Thickness (mil)	Stud Web Type	Ultimate Load (lb.)
13	350S162-33	33	Slit Web	4,163
14	350S162-33	33	Slit Web	4,249
15	350S162-33	33	Slit Web	3,788
Average				4,067
Standard Deviation				245.13
COV				0.06

For SI: 1 mil = 1/1000 inch = 0.0254 mm, 1 lb = 4.448 N

Structural Performance of Slit-Web Steel Wall Studs



ShearWall Test

Table 6 presents the results of the shearwall tests. Load-displacement curves are shown in Appendix A.

Table 6 – Shearwall Test Results

Test No.	Stud Size	Stud Thickness (mil)	Stud Web Type	Test Method	Ultimate Load (lb.)	Stud Thickness (in.)
16	350S162-33	33	Slit Web	ASTM E564	4,114	0.0341
17	350S162-33	33	Slit Web	ASTM E72	4,865	0.0341

For SI: 1 mil = 1/1000 inch = 0.0254 mm, 1 lb = 4.448 N

Test No. 16 was done in accordance with the ASTM E564 [14] test setup. The hold-down was mounted externally to the side of the wall stud. During the test, the hold down connection tore out of the slotted web of the end (tension chord) stud and was considered to be the limiting failure mode (premature failure before the panel capacity was reached). The test was repeated (Test No. 17) using the ASTM E72 [13] test setup in an attempt to eliminate the source of the premature failure and to observe secondary failure modes.

Shear Tests

Table 7 presents the results of the shear tests for the slit-web stud. Load-deflection curves are shown in Appendix A.

Table 7– Shear Test Results

Test No.	Stud Size	Stud Thickness (mil)	Stud Web Type	Ultimate Load (lb.)
18	350S162-33	33	Slit Web	881
19	350S162-33	33	Slit Web	951
20	350S162-33	33	Slit Web	924
Average				919
Standard Deviation				28.83
COV				0.0314

For SI: 1 mil = 1/1000 inch = 0.0254 mm, 1 lb = 4.448 N

Structural Performance of Slit-Web Steel Wall Studs



FAILURE MODE

Bending Tests

The observed failure mode of the slit-web studs in all bending tests was mainly local buckling under the point load with some distortional buckling. The failure mode was similar to that of the solid-web stud. Refer to Appendix A for photos of failure mode.

Axial Tests

The observed failure mode of the slit-web studs was mainly buckling of the webs between the OSB sheets (for all tests). The failure mode was similar for the solid-web stud. The OSB sheets prevented overall column buckling. Refer to Appendix A for photos of failure mode.

Stub-Column Tests

The observed failure mode of the slit-web stud stub-column tests was mainly distortional buckling at mid-height of the stud. Refer to Appendix A for photos of failure mode.

Shearwall Tests

The first shearwall test (Test No. 16) was tested in accordance with ASTM D564 test method. The hold-down tore the slotted section of the stud out before the panel's capacity was reached. The test was repeated under the ASTM E72 test method with one end stud (compression stud). Again, the wall failed prematurely at the tension chord before the panel's capacity was reached. No failure in the screws or the sheathing was observed during both tests.

Shear Tests

Specimens tested for shear failed in localized buckling of the flanges under the point load. Refer to Appendix A for photos of failure mode

DISCUSSION

The bending and axial tests showed that a slit-web stud outperformed a solid web stud (higher by 50% and 45% respectively). A portion of the increase in bending and axial capacity can be attributed to the higher yield and ultimate strengths of the slit-web stud (higher by 27% and 30% respectively). The failure modes for both the slit-web and solid-web studs were similar indicating that the louvered slits and edge stiffeners of the slit-web stud caused it resist higher loads.

The shear strength of the slit-web stud is compared to the calculated shear strength of a solid web stud in Table 8. The ultimate shear strength of the solid-web stud was determined in accordance with the AISI Specification using a factor of safety of 1.67. Furthermore, the average thickness, yield strength, and ultimate strength for the slit-web stud were used in calculating the shear capacity of the solid web stud.

Structural Performance of Slit-Web Steel Wall Studs



Table 8– Shear Load Comparison

Stud Size	Stud Thickness (mil)	Stud Web Type	Ultimate Shear Strength ¹ (lb.)	Stud Thickness (in.)
350S162-33	33	Slit Web	919 ²	0.0341
350S162-33	33	Solid Web	825	0.0340

For SI: 1 mil = 1/1000 inch = 0.0254 mm, 1 lb = 4.448 N

¹ The ultimate shear strength of the solid-web stud (punched) was calculated in accordance with the AISI Specification using a factor of safety of 1.67 to adjust up to ultimate load.

² Average tested value (see Table 7).

From the above comparison, it is concluded that the shear value for both studs are similar.

Comparison of the slit-web stud shearwall test results to those of a solid-web stud could not be made because the slit-web stud test specimen failed prematurely before the panel’s ultimate capacity was reached. The International Building Code (IBC) [15] gives the ultimate (unfactored) shear value for a steel-framed wall (350S162-33 steel studs) of 910 pounds per linear foot (13.28 kN/m). The 910 plf (13.28 kN/m) nominal shear value can be increased by 30% if fully blocked gypsum board is applied to the opposite side of the wall. Therefore, the total shear value of the wall specimen should be 1,183 plf (17.26 kN/m). The IBC shear values are based on double studs at shearwall ends. The ultimate shear load achieved for the slit-web stud tests is 4,865 lb (21.64 kN), which is equivalent to 608 plf (8.87 kN/m). It is believed that the IBC code shear value could have been achieved if double chord studs were used in this test program.

The average effective area at the ultimate load, A_{eua} , of the slit-web stud is derived from the results of the stub-column tests in accordance with Part VII of the AISI Specification.

$$A_{eua} = P_{ua}/F_{ya}$$

Where,

- A_{eua} = Effective area.
- P_{ua} = Stub-column test ultimate load.
- F_{ya} = Measure yield strength of steel.

$$A_{eua} = 4,067/38,700 = 0.1051 \text{ in}^2.$$

Structural Performance of Slit-Web Steel Wall Studs



CONCLUSION

In this report, the behavior of 3-1/2 inch (89 mm) slit-web stud (perforated web) was studied. Test results showed that the prototype slit web stud performed similar to or better than a solid-web stud in bending, axial, and shear tests. The shearwall test results indicated the importance of using multiple chord studs and the need to address the connection to the tension chord end stud where heavy connections are made and locally high compressive and tension forces must be transferred through connections or bearing of end studs. Tests also showed that the slit-web stud is very sensitive to the distortional buckling mode. The stub-column tests provided an effective area for the slit-web stud. The effective area is approximately 50% of the gross area.

The 350S162-33 slit-web stud developed and tested in this report was shown to be better than or essentially equivalent to a 350S162-33 solid-web stud in most structural performance characteristics investigated. The reduction in capacity due to the presence of the slots in the web is compensated for by the addition of the draw-in hole (along the centerline of the web), the edge stiffeners, and the bent (louvered) slits.

The application of split-web studs in shearwalls where heavy connections are needed and locally high compressive and tension forces are developed and must be transferred through connections or bearing of end studs should be investigated.

Web crippling was not investigated for the slit-web stud, as it is not considered a failure mode for wall studs constructed within the applicability limits of the Prescriptive Method (fully sheathed walls) [16]. Web crippling strength should be investigated when slit-web studs are used in non-sheathed wall applications.

Structural Performance of Slit-Web Steel Wall Studs



REFERENCES

- [1] “*Thermal Design Guide for Exterior Walls*” American Iron and Steel Institute (AISI) Publication RG-9405. Washington, DC. January 1995.
- [2] Elhadj, Nader “*Thermal Performance of Slit-Web Steel Studs*” Report Prepared for the American Iron and Steel Institute (AISI), Steel Framing Alliance, and the U.S. Department of Energy by the NAHB Research Center, Inc. Upper Marlboro, MD. 2002.
- [3] Errera, S. L “*Tests of Wall Panels and Components for Mode 1 Residential Steel Framing Systems*” Bethlehem Steel Corporation Report No. 72-7-3. Bethlehem Pennsylvania. August 1974.
- [4] Ratliff, G. D., and Roeder, G. M. “*Thermal and Structural Behavior of Walls Made with Steel Studs with Slit Webs*” United States Steel Corp. Applied research report No. 57.019-52(5). Pittsburgh PA. December 1971.
- [5] Kesti, Jyrki and Makelainen, Pentti “*Compression Behavior of Perforated Steel Wall Studs*” Helsinki University of Technology-Laboratory of Steel Structures. December 1997.
- [6] “*Light Steel Framing for Housing – The Slotted Stud*” The Swedish Institute of Steel Construction (SBI). www.sbi.se/lattbygg/slott-e.htm.
- [7] Hoglund, Torsten “*Design of Light-Gauge Studs with Perforated Web*” Department of Structural Engineering - Royal Institute of Technology. Stockholm Sweden.
- [8] “*Finnsteel Technology Programme 1995-2000*” TEKES Technology Programme Report 7/2001. Helsinki. ISBN 952-457-024-6. 2001.
- [9] ASTM A370-02, “*Standard Test Methods and Definitions for Mechanical Testing of Steel Products*” American Society for Testing and Materials (ASTM), West Conshohocken PA.
- [10] ASTM A90/A90M-01 “*Standard Test Method for Weight [Mass] of Coating on Iron and Steel Articles with Zinc or Zinc-Alloy Coatings*” American Society for Testing and Materials (ASTM), West Conshohocken PA.
- [11] ASTM D198-99 “*Standard Test Methods of Static Tests of Lumber in Structural Sizes*” American Society for Testing and Materials (ASTM), West Conshohocken PA.
- [12] “*Cold-Formed Steel Design Manual: Specification for the Design of Cold-Formed Steel Structural Members*” 1996 Edition, and 1999 Supplement. American Iron and Steel Institute (AISI). Washington DC. 1996.
- [13] ASTM E72-98 “*Standard Test Methods of Conducting Strength Tests of Panels for Building Construction*” American Society for Testing and Materials (ASTM), West Conshohocken PA.
- [14] ASTM E564-00e1 “*Standard Practice for Static Load Test for Shear Resistance of Framed Walls for Buildings*” American Society for Testing and Materials (ASTM), West Conshohocken PA.
- [15] IRC 2000. “*International Building Code*” International Code Council, Falls Church, Virginia. 2000.

Structural Performance of Slit-Web Steel Wall Studs



- [16] AISI/COFS/PM 2001 “*Standard for Cold-Formed Steel Framing - Prescriptive Method for One and Two Family Dwellings*” American Iron and Steel Institute (AISI), Washington DC. June 2000.

Structural Performance of Slit-Web Steel Wall Studs





**APPENDIX A
TEST RESULTS**

Structural Performance of Slit-Web Steel Wall Studs



Structural Performance of Slit-Web Steel Wall Studs

Table A1 - Physical and Mechanical Properties of Test Specimens

Member Designation	Web Configuration	Web Size (in)	Flange Size (in)	Lip Size (in)	Yield Point ¹ (ksi)	Tensile Strength ¹ (ksi)	Uncoated Thickness² (in)	Elongation ³ (percent) ^{1/2"} Gauge
350S162-33	Slit	3.50	1.625	0.5	39.4	59.0	0.0341	19.8
350S162-33	Slit	3.50	1.625	0.5	37.7	61.4	0.0342	19.2
350S162-33	Slit	3.50	1.625	0.5	39.1	60.6	0.0340	18.7
Average		3.50	1.625	0.5	38.7	60.3	0.0341	19.2
Standard Deviation		0	0	0	0.91	1.22	0.0001	0.55
COV		0	0	0	0.23	0.02	0.0029	0.03
350S162-33	Solid	3.50	1.625	0.5	33.9	45.5	0.0339	20.2
350S162-33	Solid	3.50	1.625	0.5	34.3	47.2	0.0341	19.8
350S162-33	Solid	3.50	1.625	0.5	35.1	46.9	0.0340	20.5
Average		3.50	1.625	0.5	34.4	46.5	0.0340	20.2
Standard Deviation		0	0	0	0.61	0.91	0.0001	0.35
COV		0	0	0	0.02	0.02	0.0029	0.02

Structural Performance of Slit-Web Steel Wall Studs

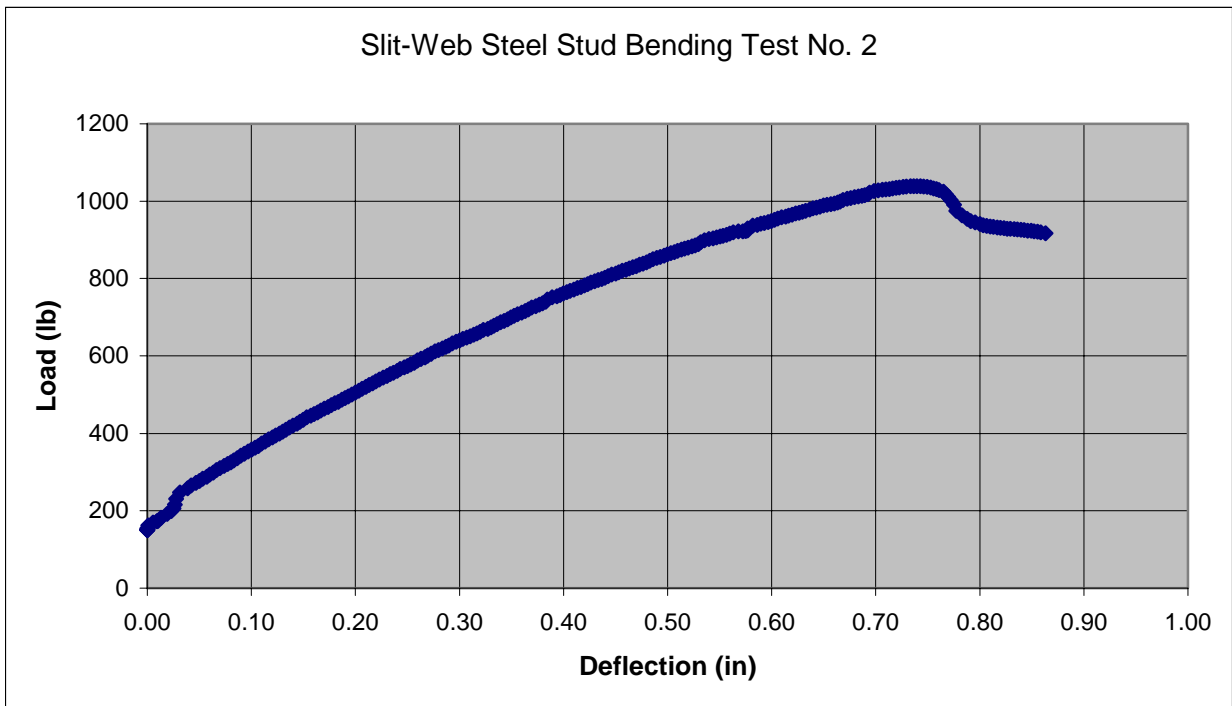
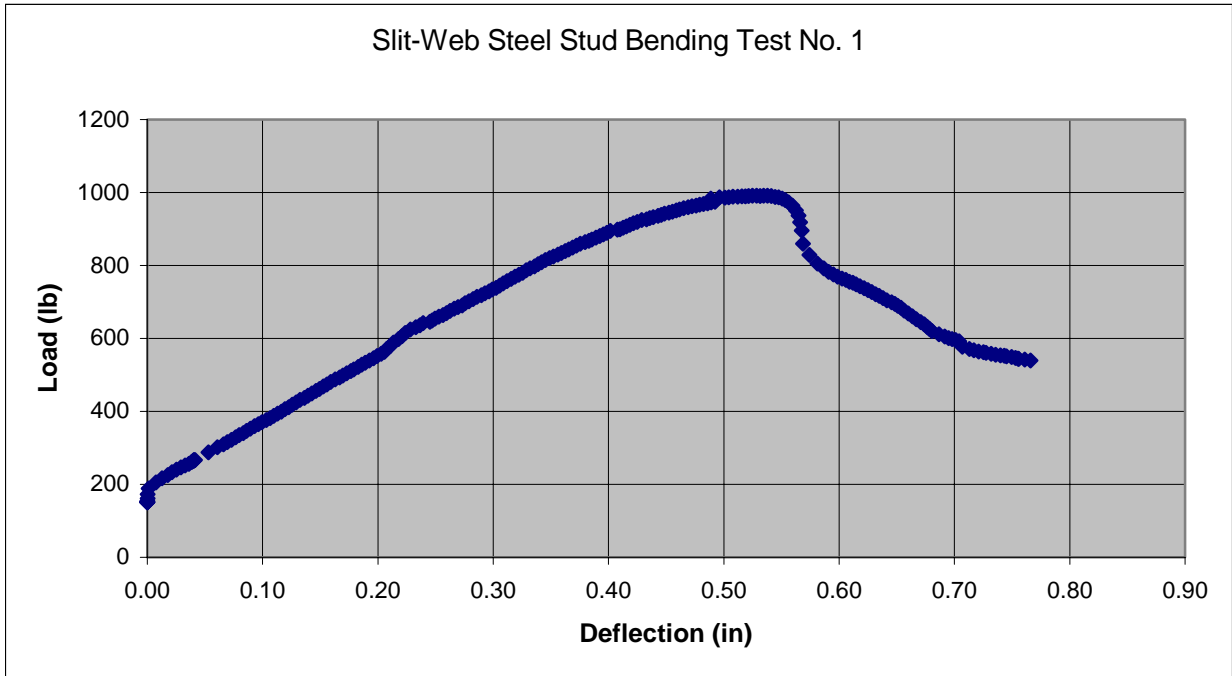

Structural Performance of Slit-Web Steel Wall Studs

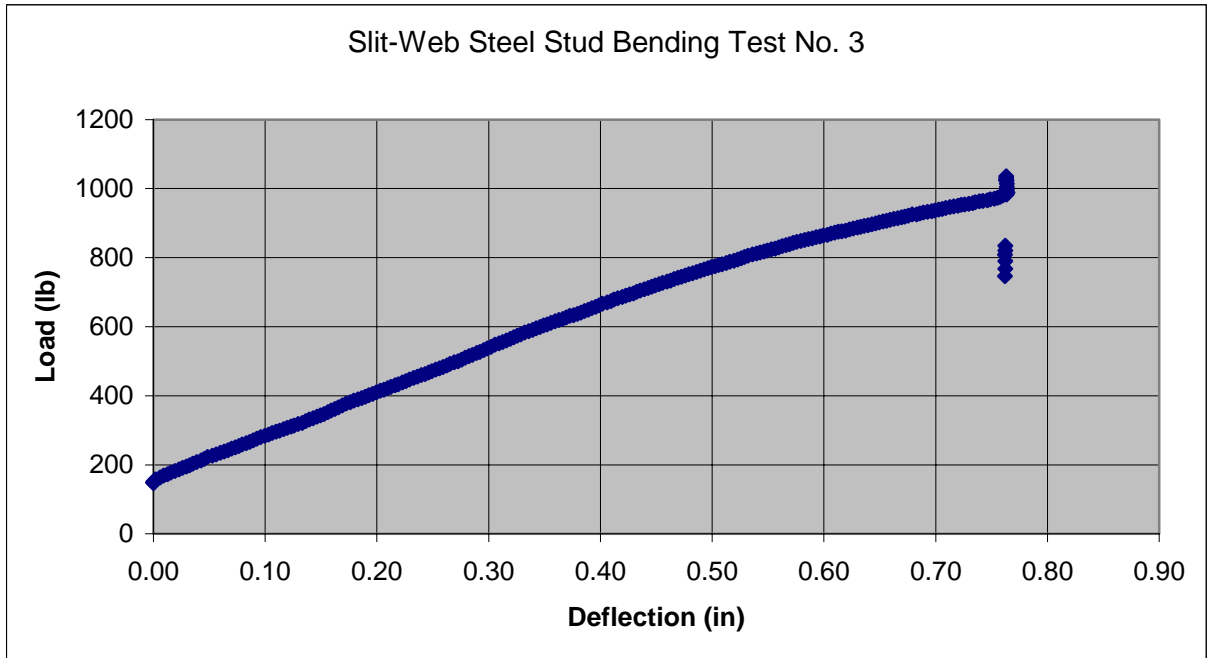

Structural Performance of Slit-Web Steel Wall Studs

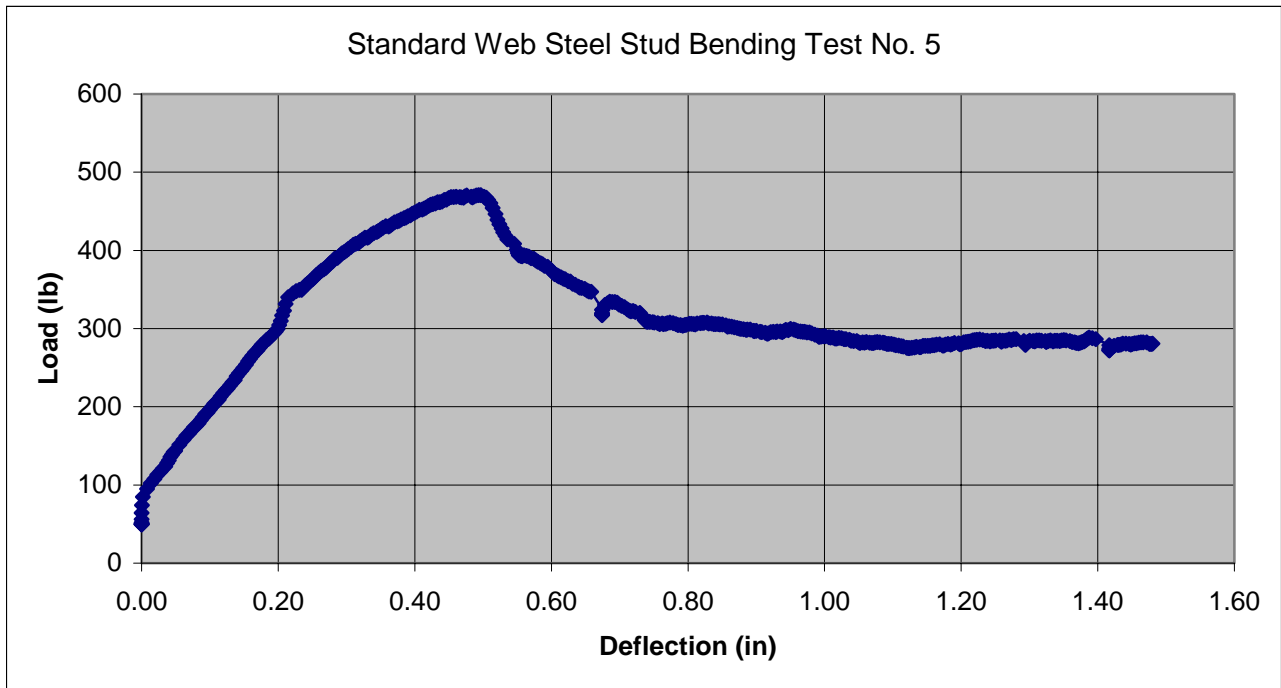
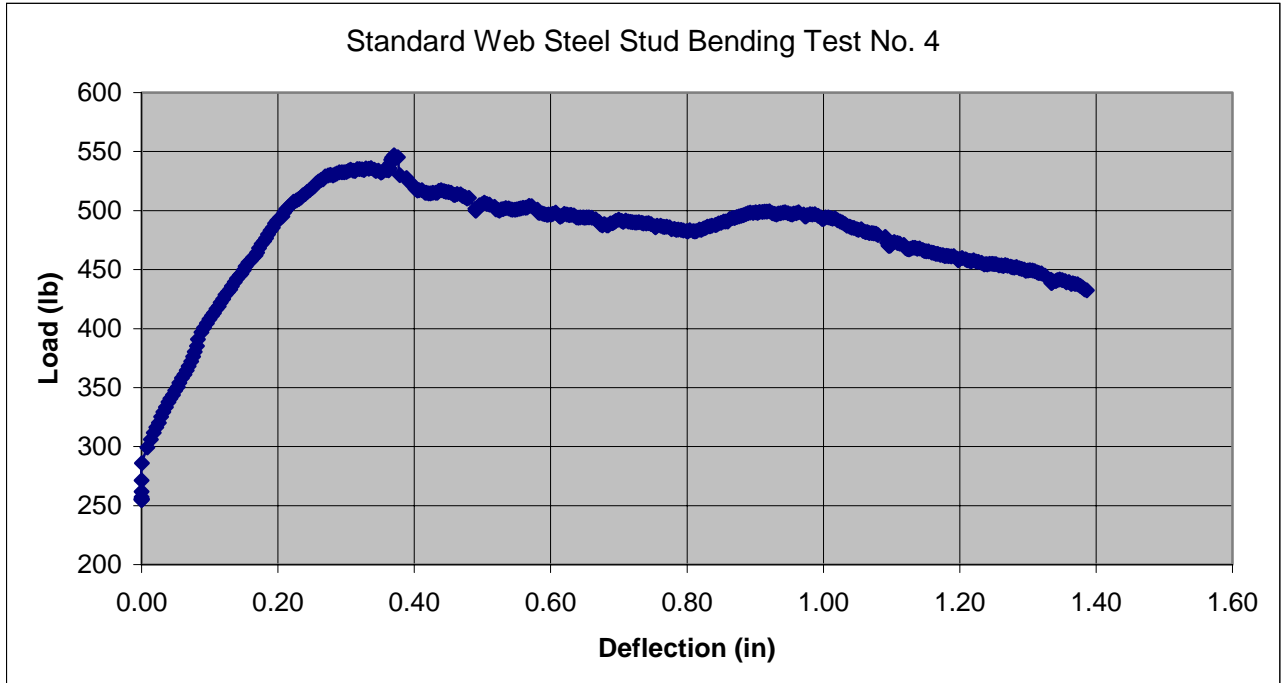

Structural Performance of Slit-Web Steel Wall Studs

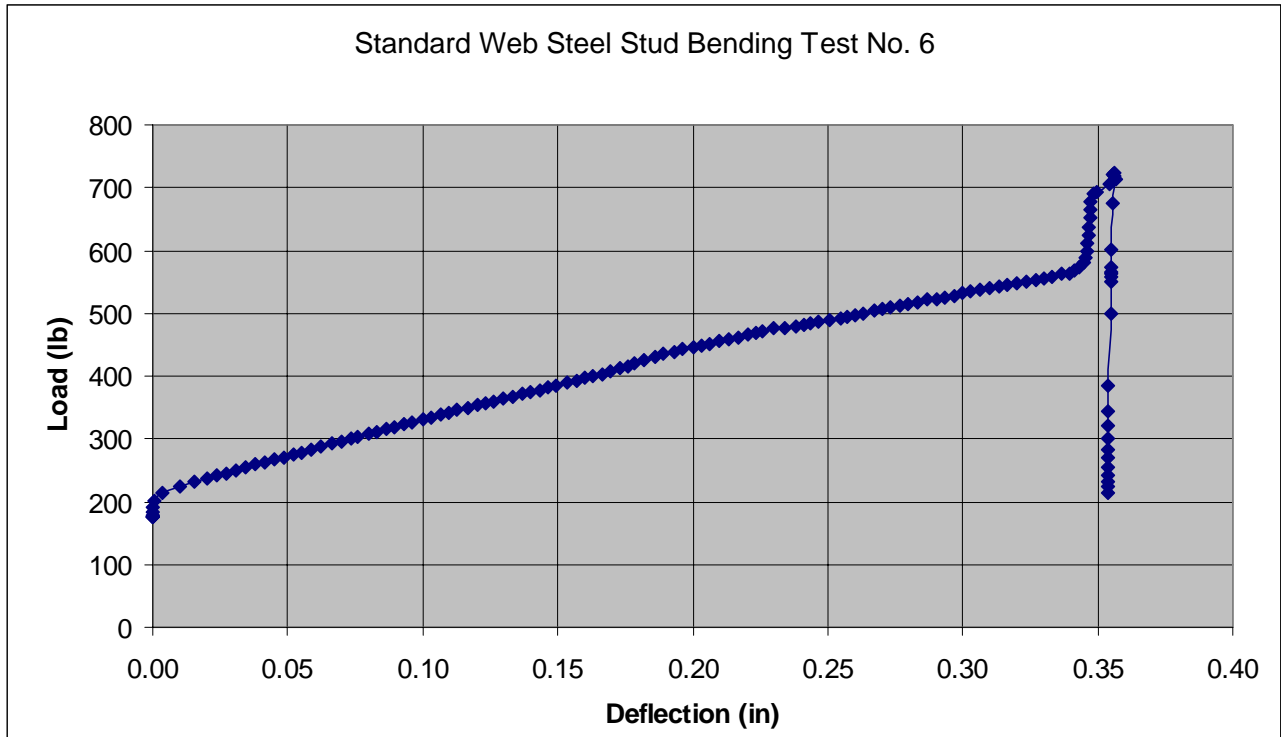

Structural Performance of Slit-Web Steel Wall Studs

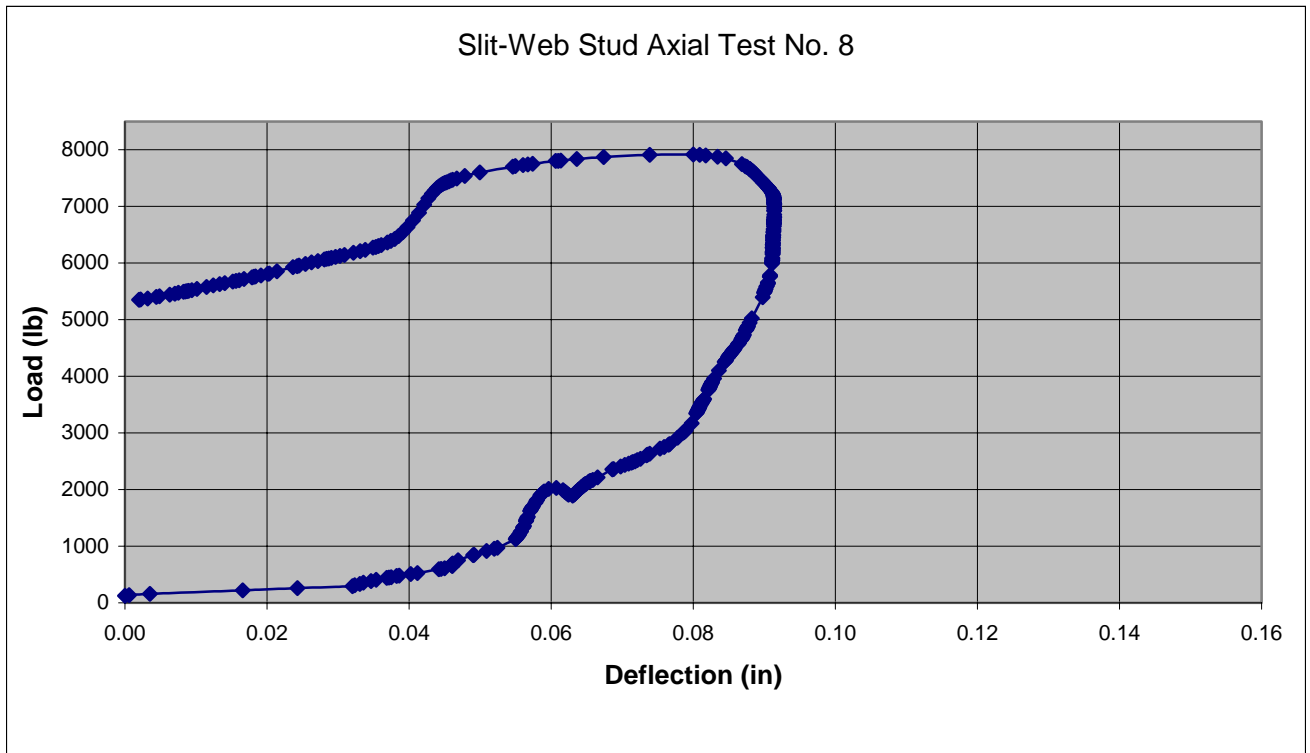
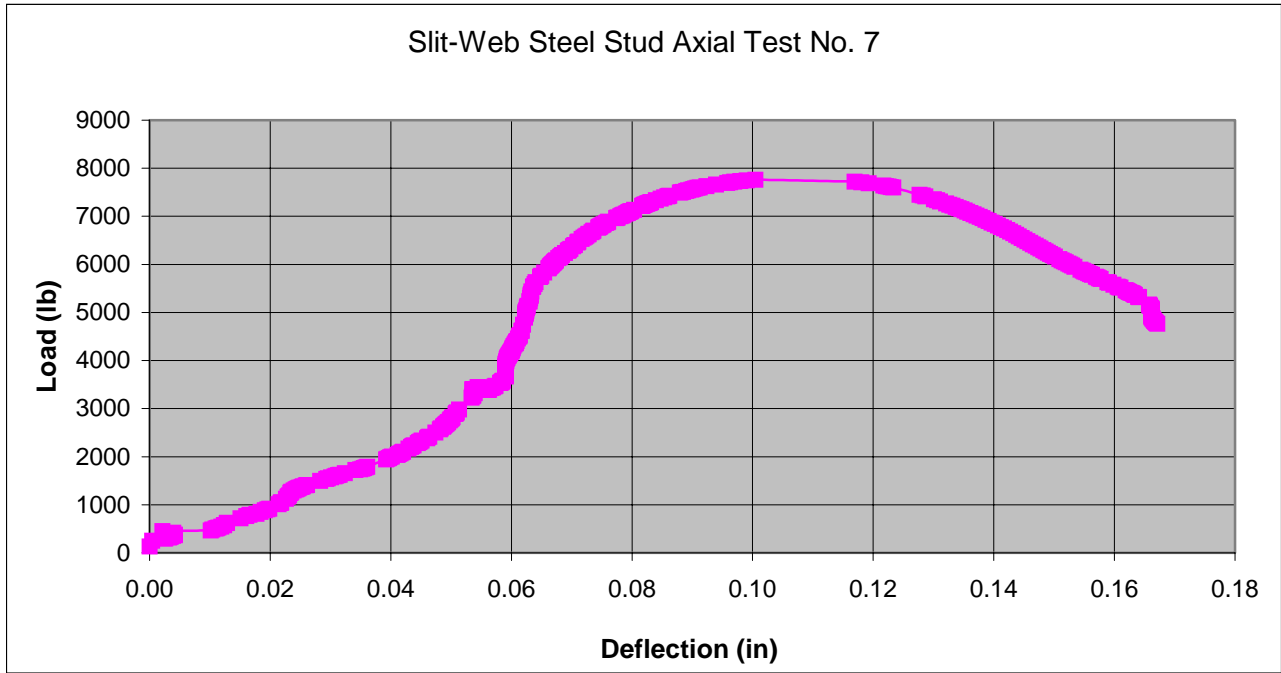

Structural Performance of Slit-Web Steel Wall Studs

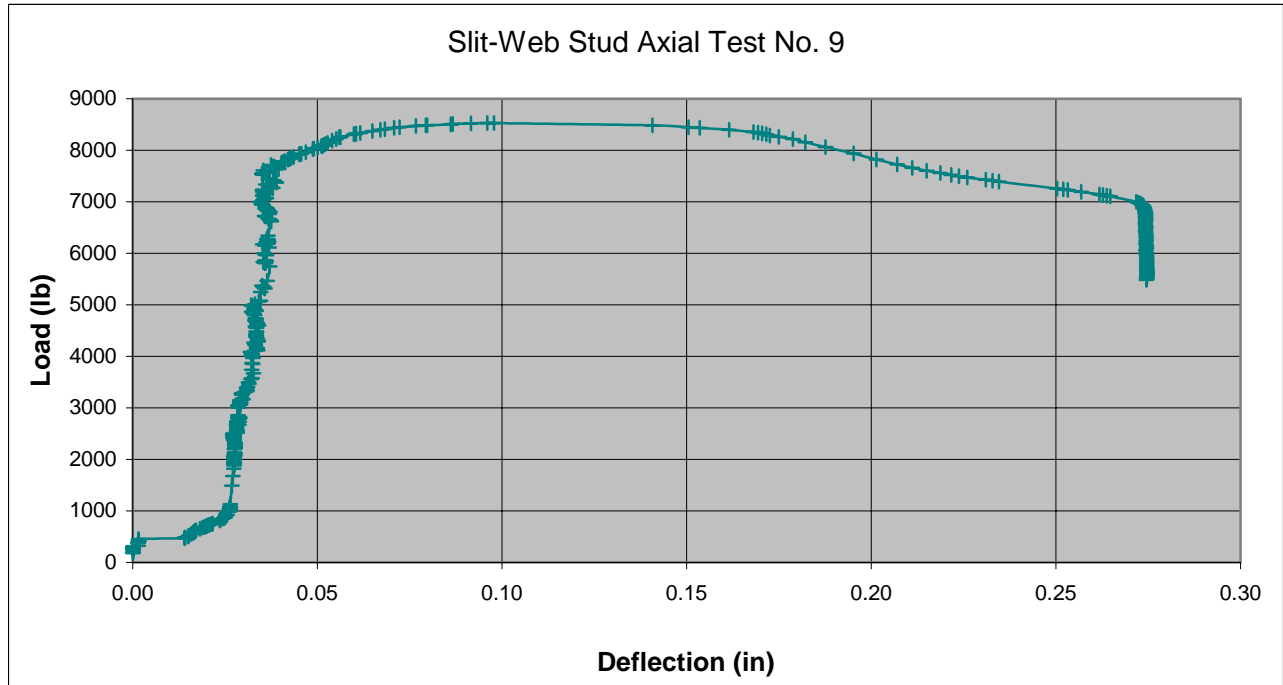

Structural Performance of Slit-Web Steel Wall Studs

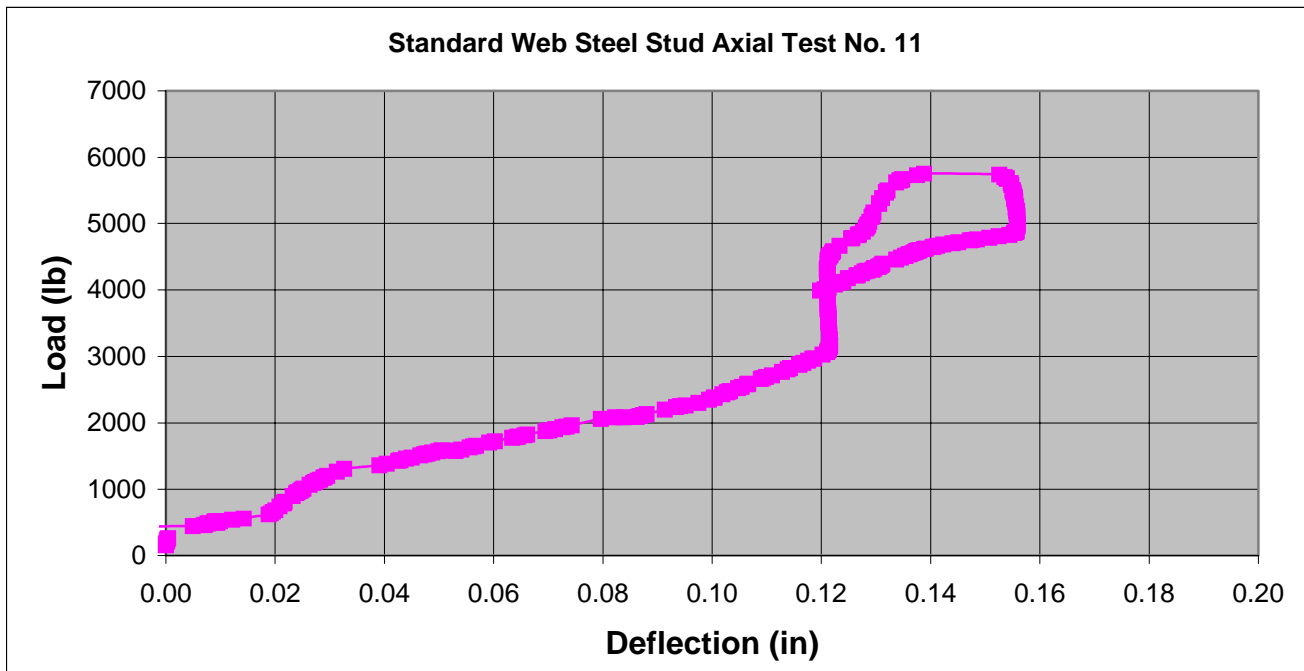
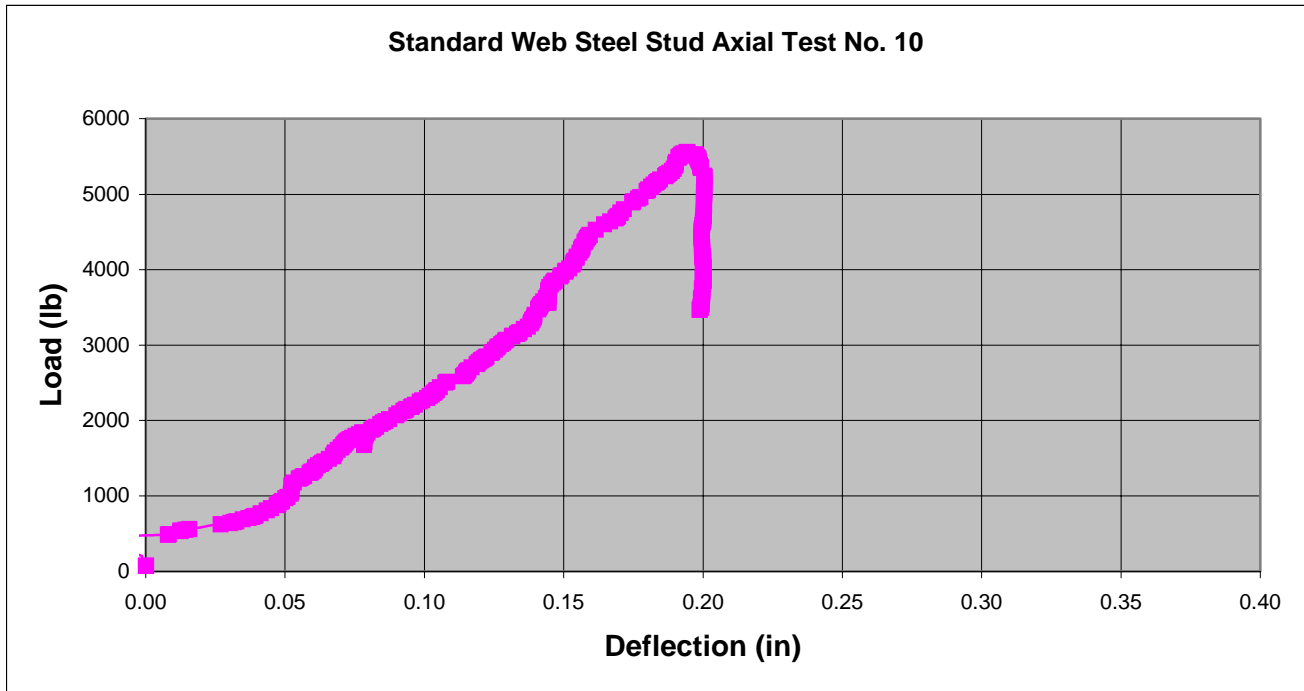

Structural Performance of Slit-Web Steel Wall Studs

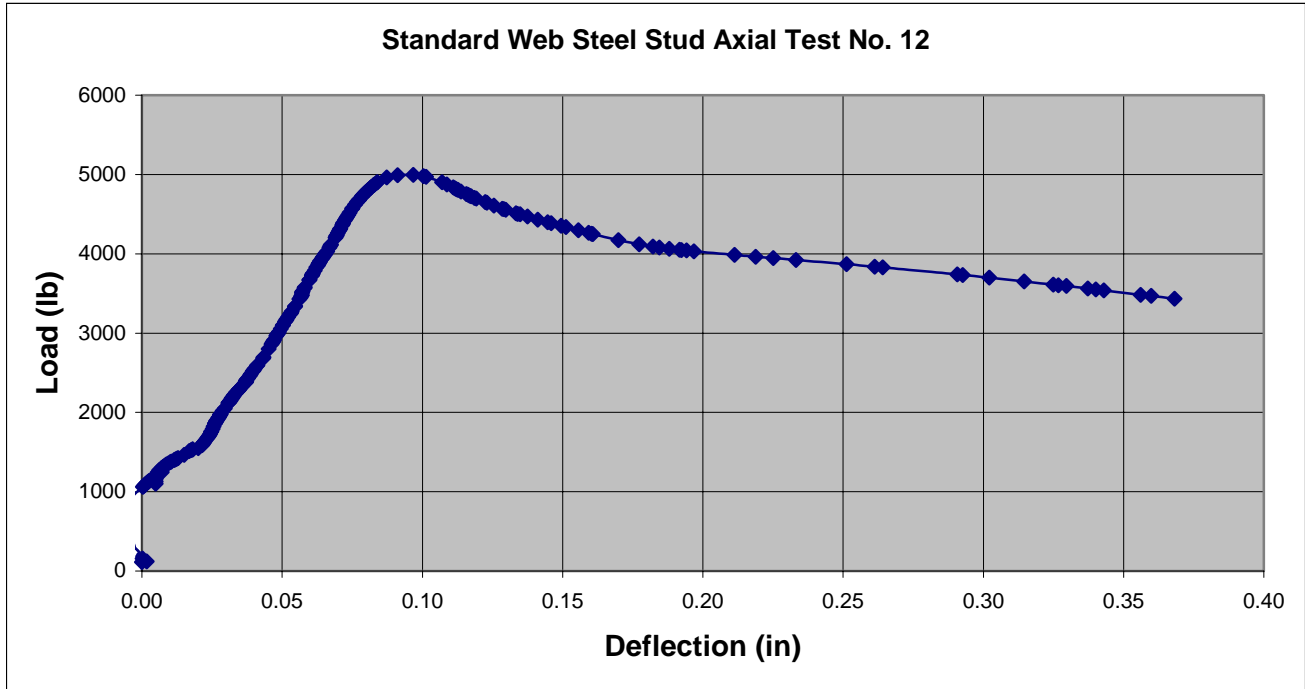

Structural Performance of Slit-Web Steel Wall Studs

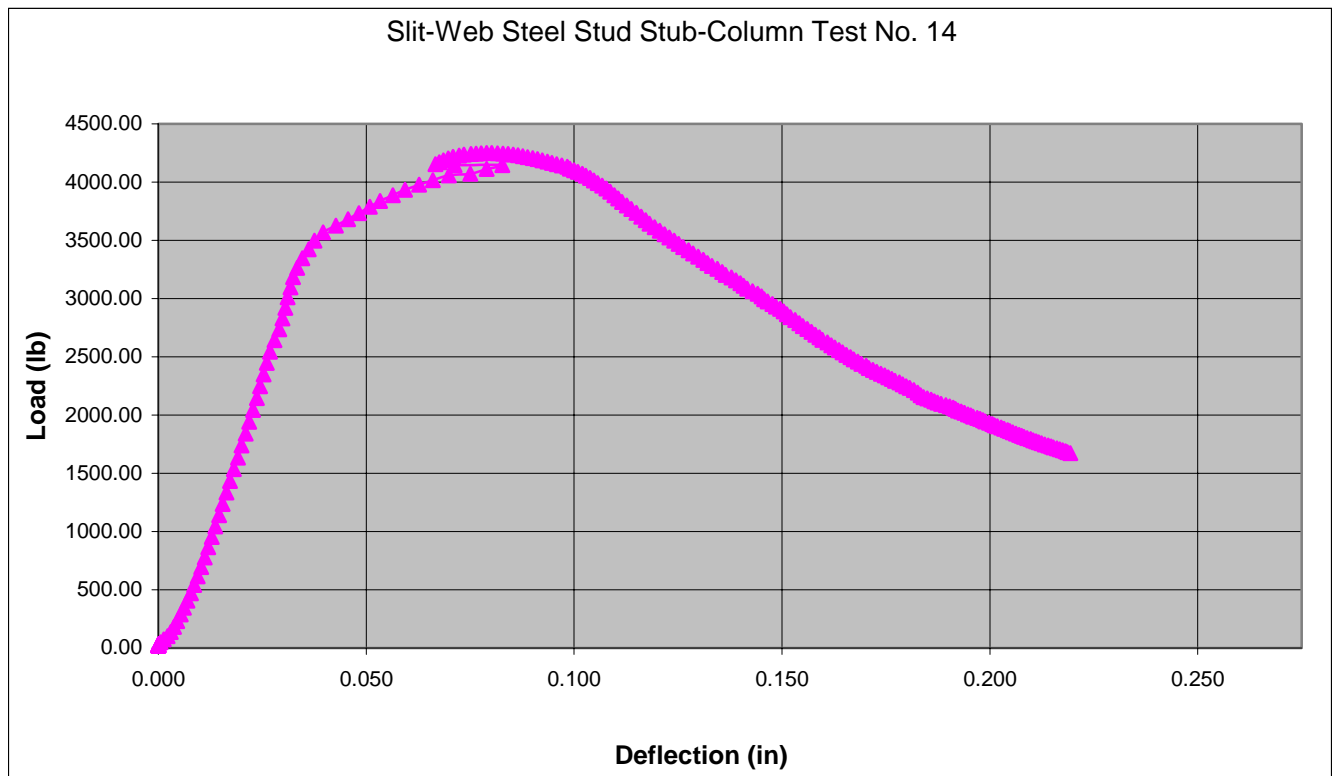
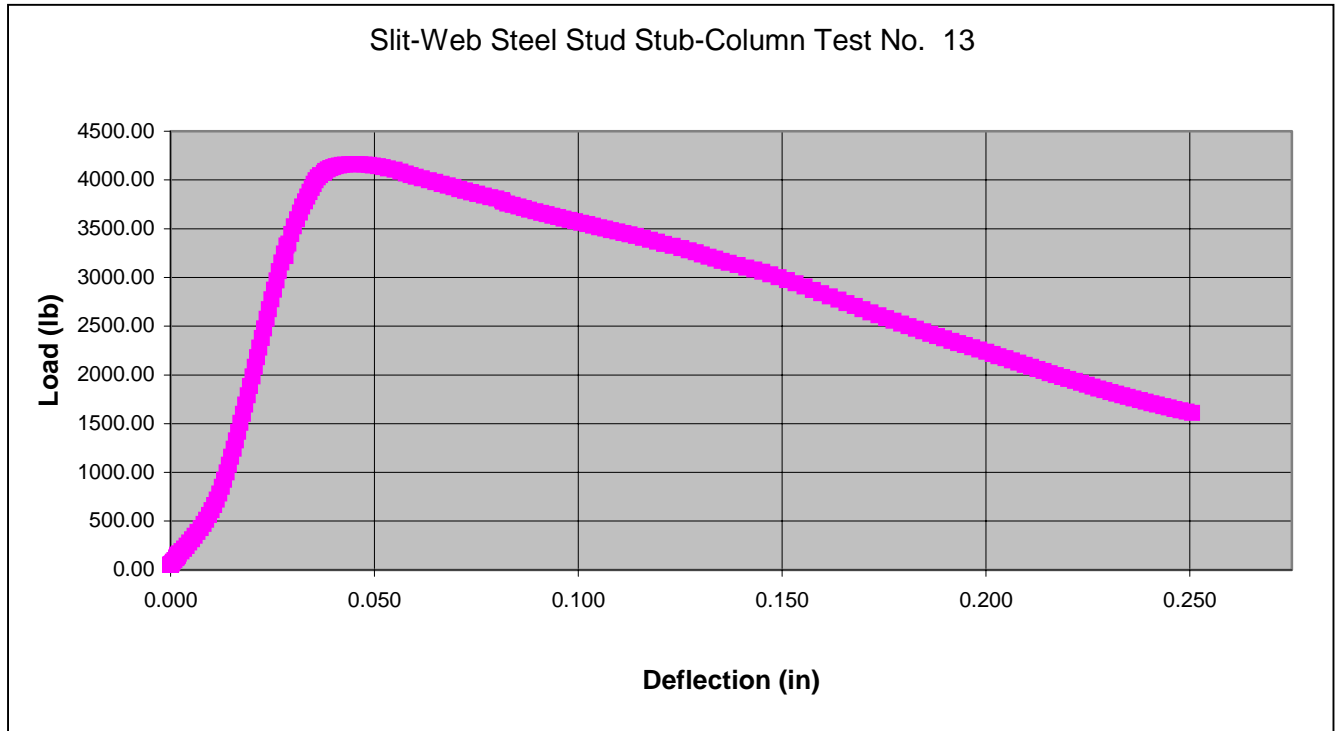

Structural Performance of Slit-Web Steel Wall Studs



Structural Performance of Slit-Web Steel Wall Studs

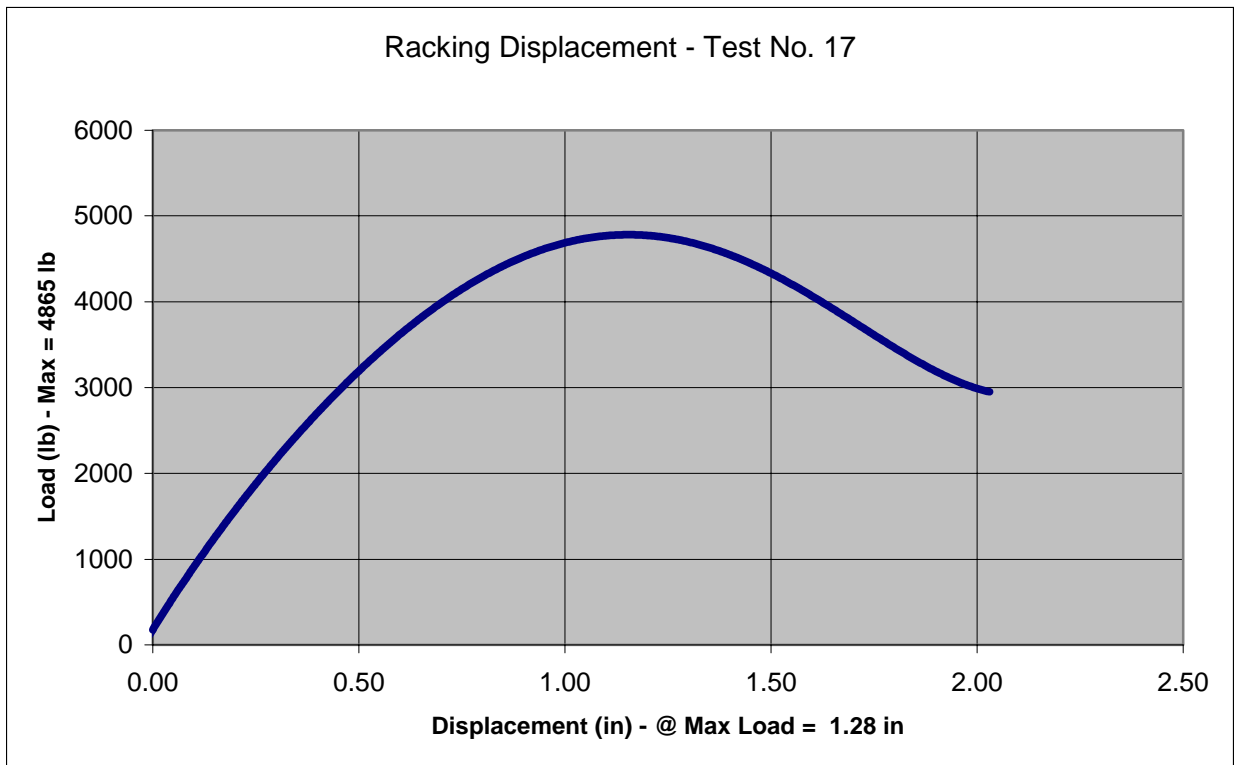
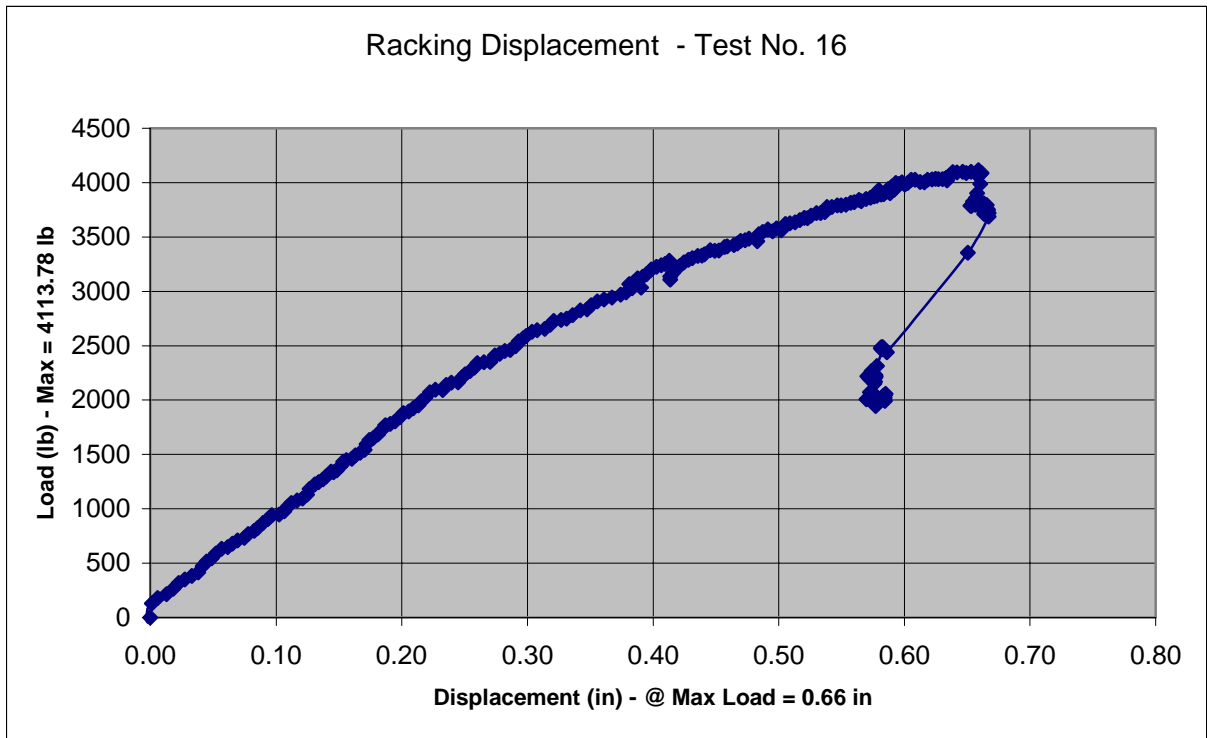

Structural Performance of Slit-Web Steel Wall Studs

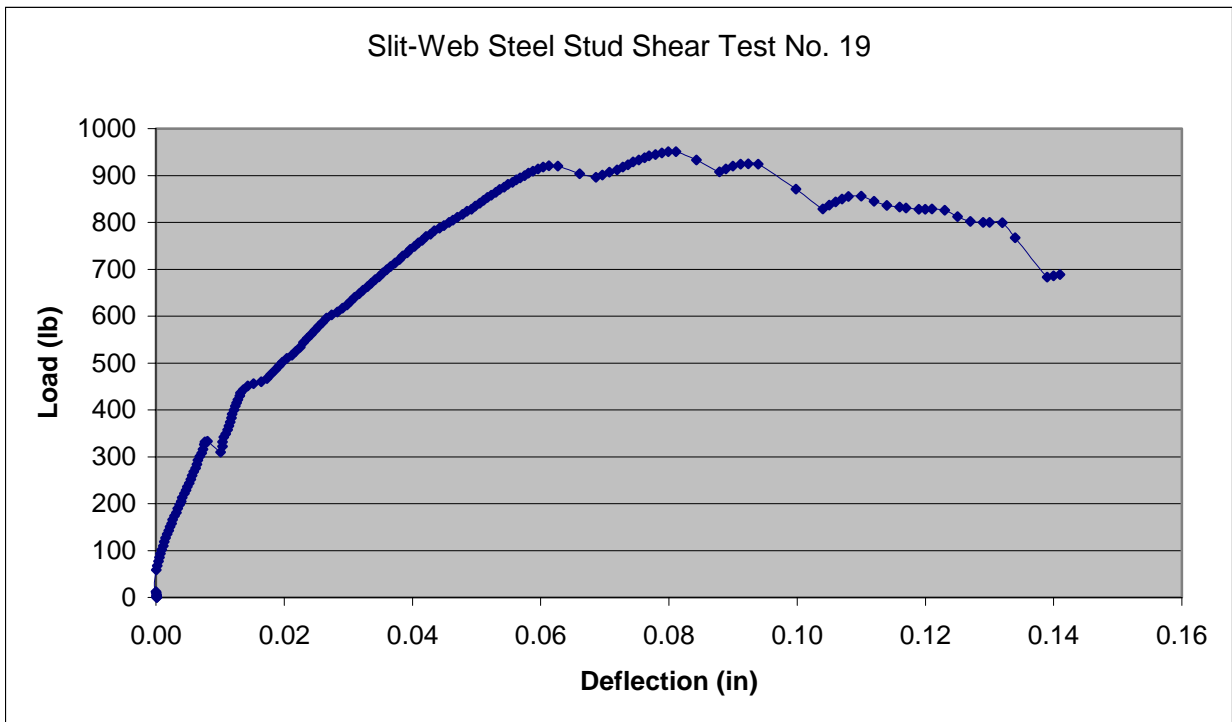
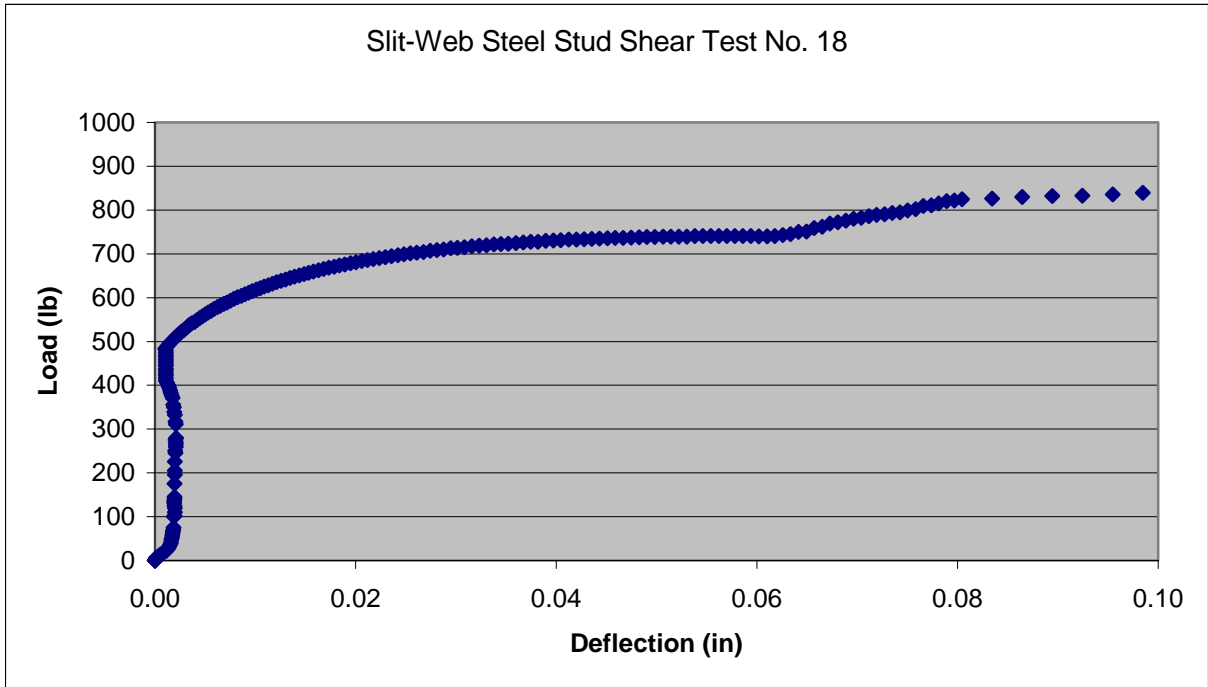

Structural Performance of Slit-Web Steel Wall Studs

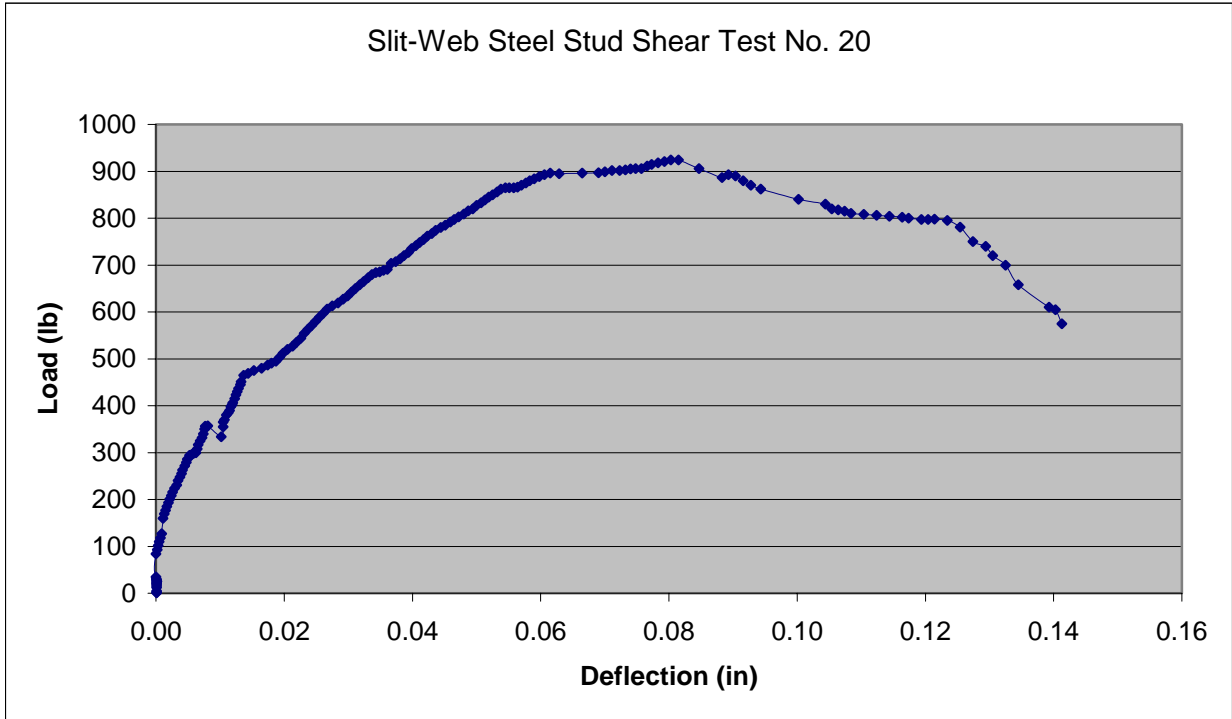



**APPENDIX B
TEST PHOTOS**

Structural Performance of Slit-Web Steel Wall Studs



Structural Performance of Slit-Web Steel Wall Studs



Slit-Web Stud Bending Test Setup

Structural Performance of Slit-Web Steel Wall Studs



Failure of Slit-Web Stud in Bending Test

Structural Performance of Slit-Web Steel Wall Studs



Slit-Web Stud Axial Test Setup and Failure Mode

Structural Performance of Slit-Web Steel Wall Studs



Slit-Web Stud Failure Mode in Axial Tests

Structural Performance of Slit-Web Steel Wall Studs



Solid Web Stud Failure Mode in Axial Tests

Structural Performance of Slit-Web Steel Wall Studs



Solid Web Stud Failure Mode in Axial Tests

Structural Performance of Slit-Web Steel Wall Studs

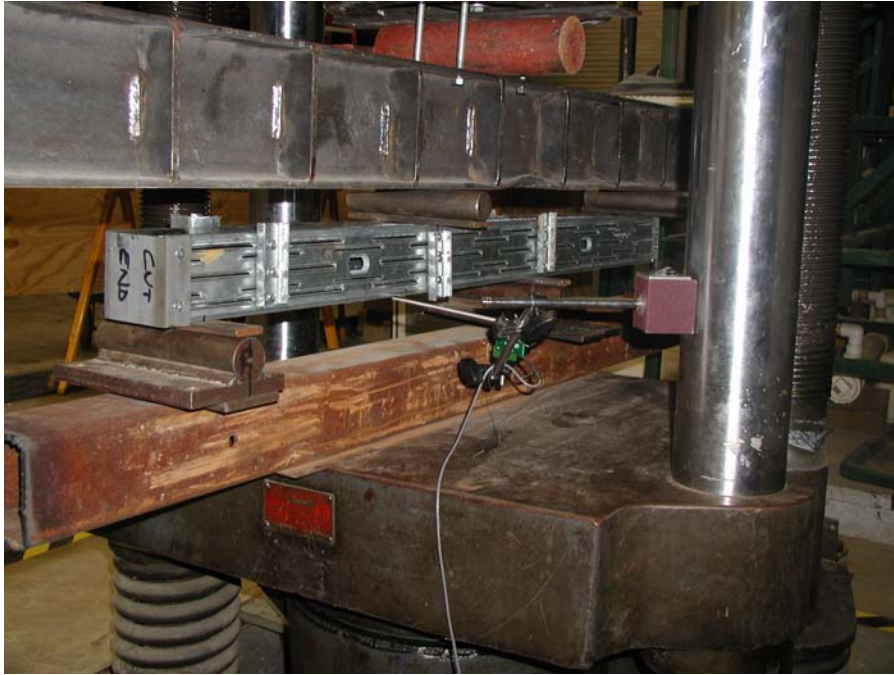

Shear Test Setup

Structural Performance of Slit-Web Steel Wall Studs



Slit-Web Stud Stub-Column Test Setup and Failure Mode



American Iron and Steel Institute

1140 Connecticut Avenue, NW
Suite 705
Washington, DC 20036
www.steel.org



Steel Framing Alliance™

Steel. The Better Builder.

1201 15th Street, NW
Suite 320
Washington, DC 20005
www.steel framing.org

